

Coding of 3D Videos based on Visual Discomfort

Can Temel and Ghassan AlRegib
School of Electrical and Computer Engineering
Georgia Tech, Atlanta, GA

November 5, 2013



1. **3VQM: A 3D Video Quality Measure**
2. **3VQM versus VDM**
3. **VDM versus SSIM and PSNR**
4. **Encoding Mode Selection**
5. **Rate Distortion Analysis**
6. **Conclusion**



A 3D Video Quality Measure (3VQM)

Stereoscopic 3D

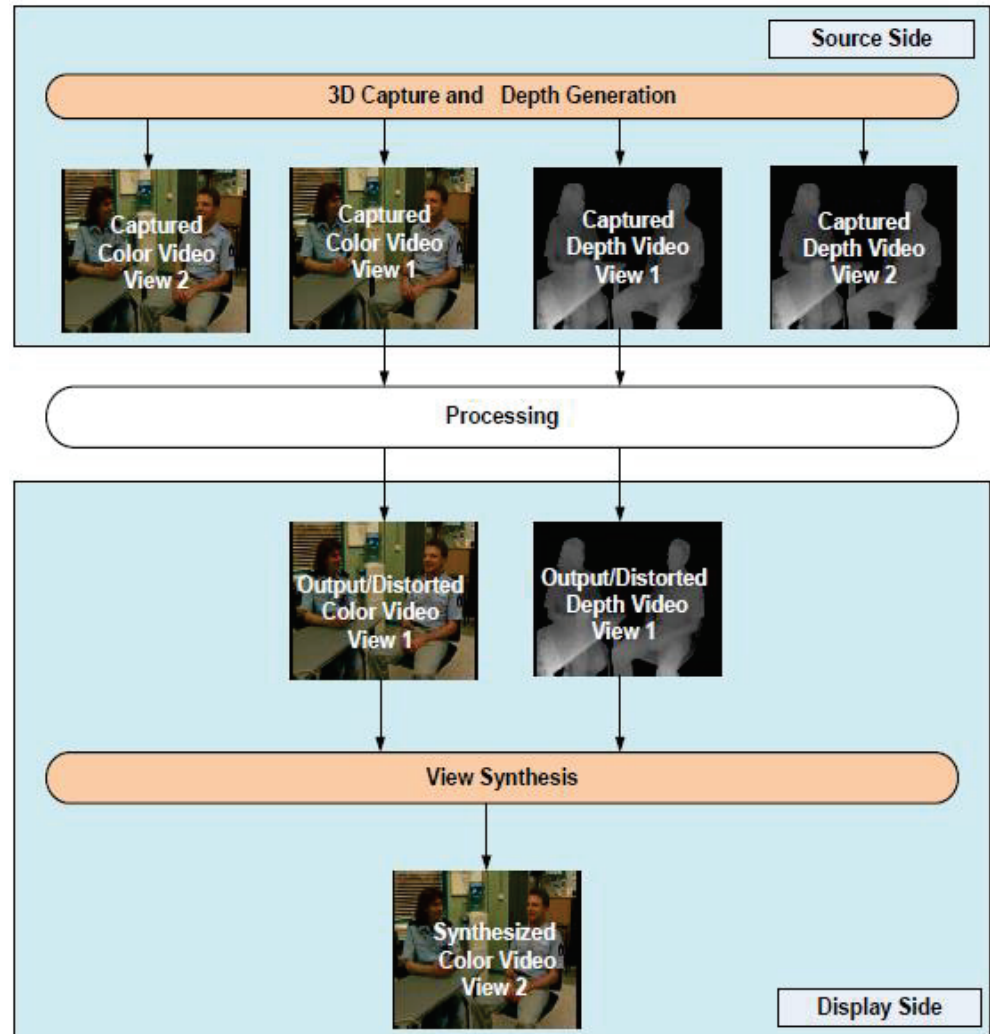

A 3D Video Quality Measure (3VQM)

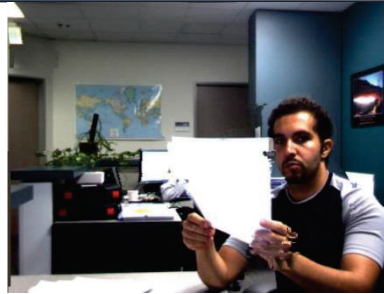

$$\Delta Z = |Z_{ideal} - Z|$$

Spatial Outliers (SO)
 $STD(\Delta Z)$

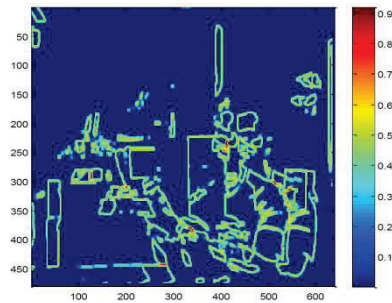

Standard deviation of
depth map errors

Temporal Outliers (TO)
 $STD(\Delta Z_K - \Delta Z_{K-1})$

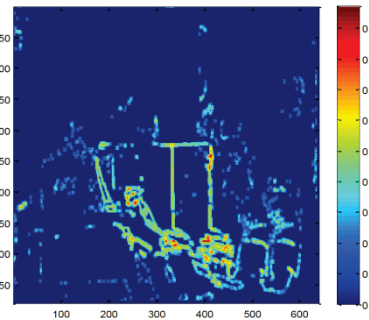

Standard deviation of two depth
map errors in time domain

Temporal Inconsistencies (TI)
 $STD(Z_K - Z_{K-1})$

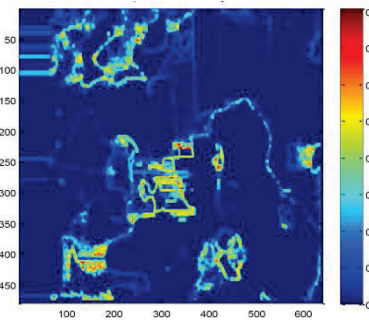

Standard deviation of two depth
values in two time instances



A 3D Video Quality Measure (3VQM)



RMSE: Root Mean Squared Error
CC: Pearson Linear Correlation Coefficient
ROCC: Spearman Rank Order Correlation Coefficient
MAE: Mean Absolute Error

Low RMSE: Accuracy
High CC: Coherency
High ROCC: Coherency
Low MAE: Accuracy

	RMSE	CC	ROCC	MAE
Average PSNR	0.95	0.73	0.72	0.82
Weighted Average PSNR	0.94	0.76	0.78	0.79
Average SSIM	0.81	0.60	0.54	0.62
3VQM	0.62	0.89	0.79	0.52



A 3D Video Quality Measure (3VQM)

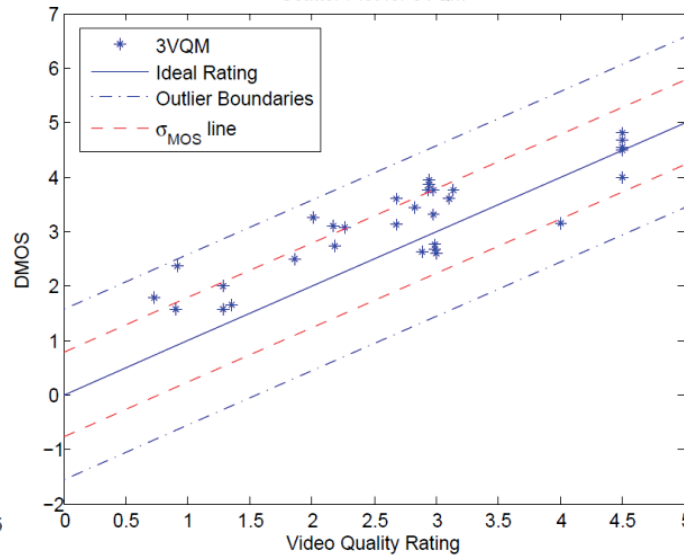
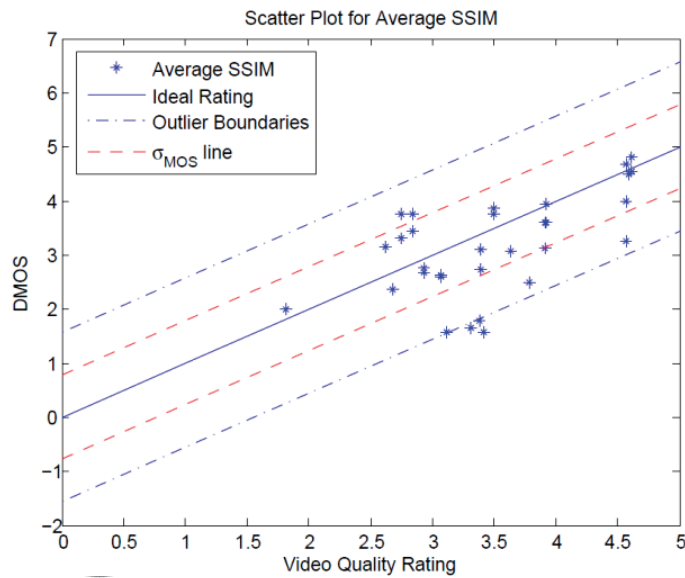
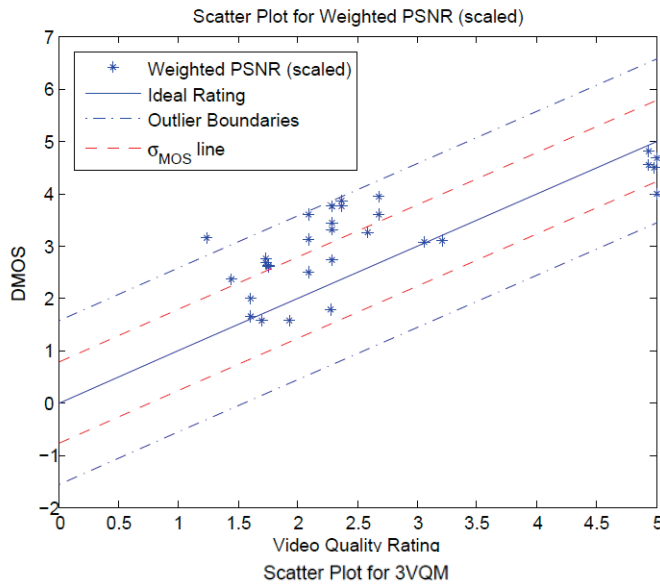
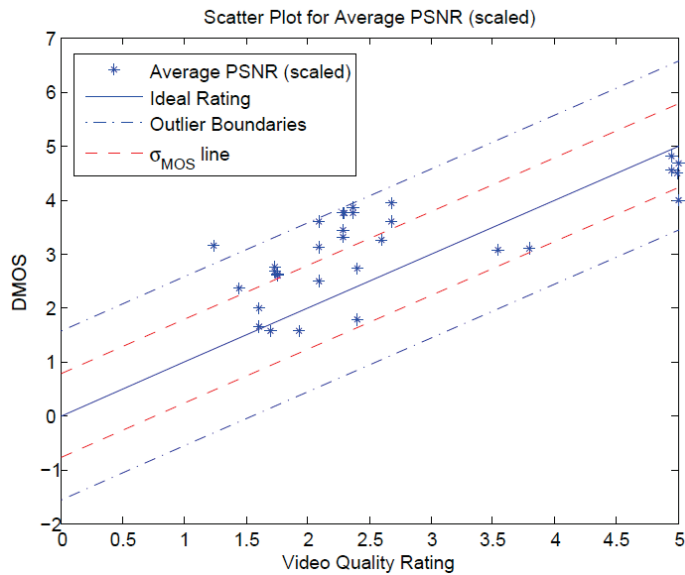

OR: Outlier Ratio Low OR: Consistency

	OR
Average PSNR	0.19
Weighted Average PSNR	0.19
Average SSIM	0.13
3 VQM	0.00

3VQM versus VDM

	3VQM	VDM
Error	$\Delta Z = Z_{ideal} - Z_{GT} $	$\Delta \hat{Z} = Z_{GT} - Z_{processed} $
Spatial Outliers	STD(ΔZ)	STD($\Delta \hat{Z}$)
Temporal Outliers	STD($\Delta Z_{t+1} - \Delta Z_t$)	STD($\Delta \hat{Z}_{t+1} - \Delta \hat{Z}_t$)
Temporal Inconsistencies	STD($Z_{t+1} - Z_t$)	STD($\hat{Z}_{t+1} - \hat{Z}_t$)
Fusing method	$K(1 - SO(SO \cap TO))^a (1 - TO)^b (1 - TI)^c$	$K(1 - SO)^a (1 - TO)^b (1 - TI)^c$
K	5.0	1.0
a	8	$\sqrt[3]{\text{Spatial Information Index}}$
b	8	$\sqrt[3]{\text{Temporal Information Index}}$
c	6	0



3VQM versus VDM

$$SInf = \sqrt[3]{\max_{time}\{std_{space}[Sobel(F_n)]\}} \quad M_n(i,j) = F_n(i,j) - F_{n-1}(i,j) \quad TInf = \sqrt[3]{\max_{time}\{std_{space}[M_n(i,j)]\}}$$



VDM versus SSIM and PSNR

Balloons

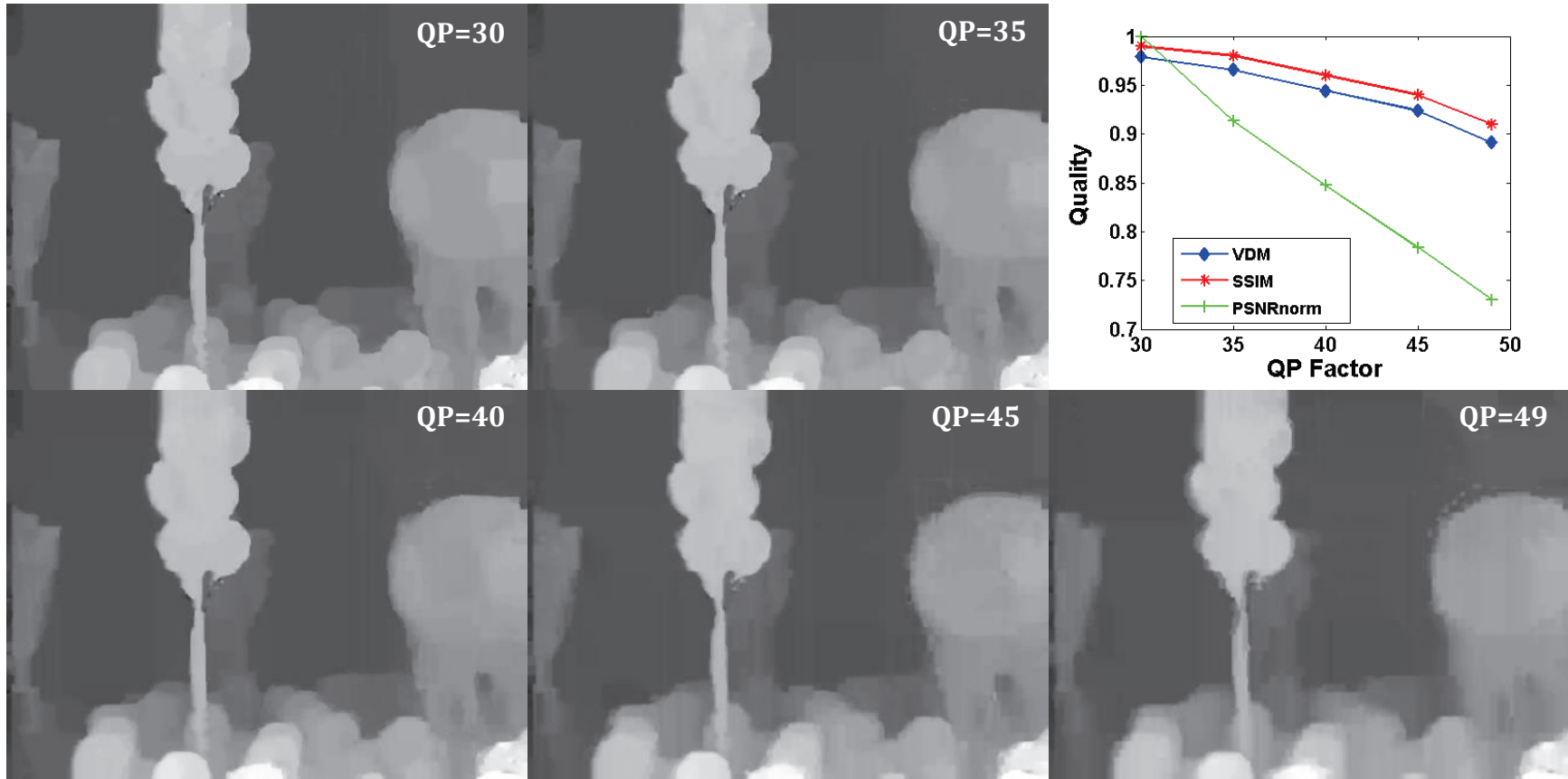

VDM versus SSIM and PSNR

Champagne Tower

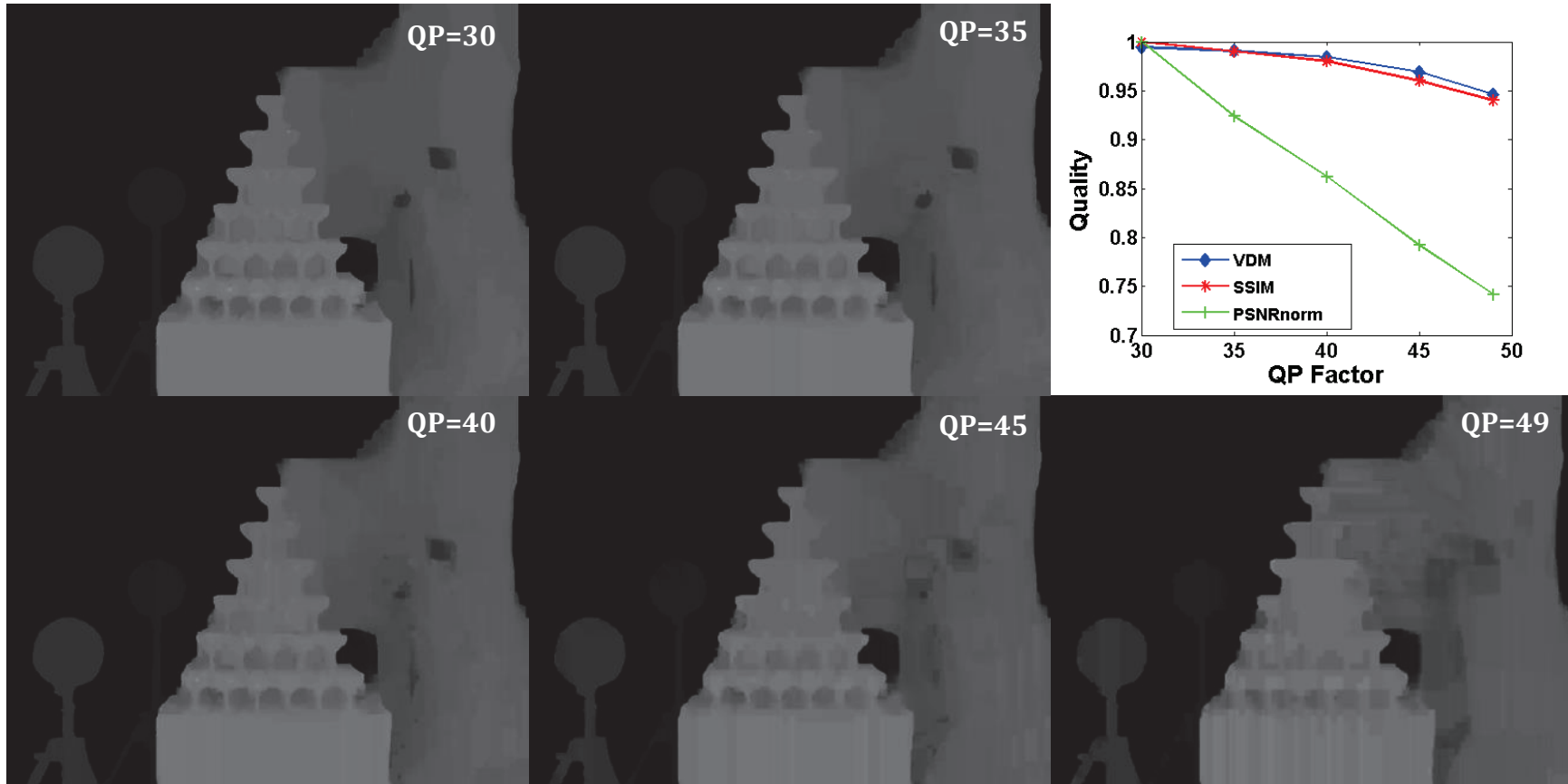

VDM versus SSIM and PSNR

Kendo

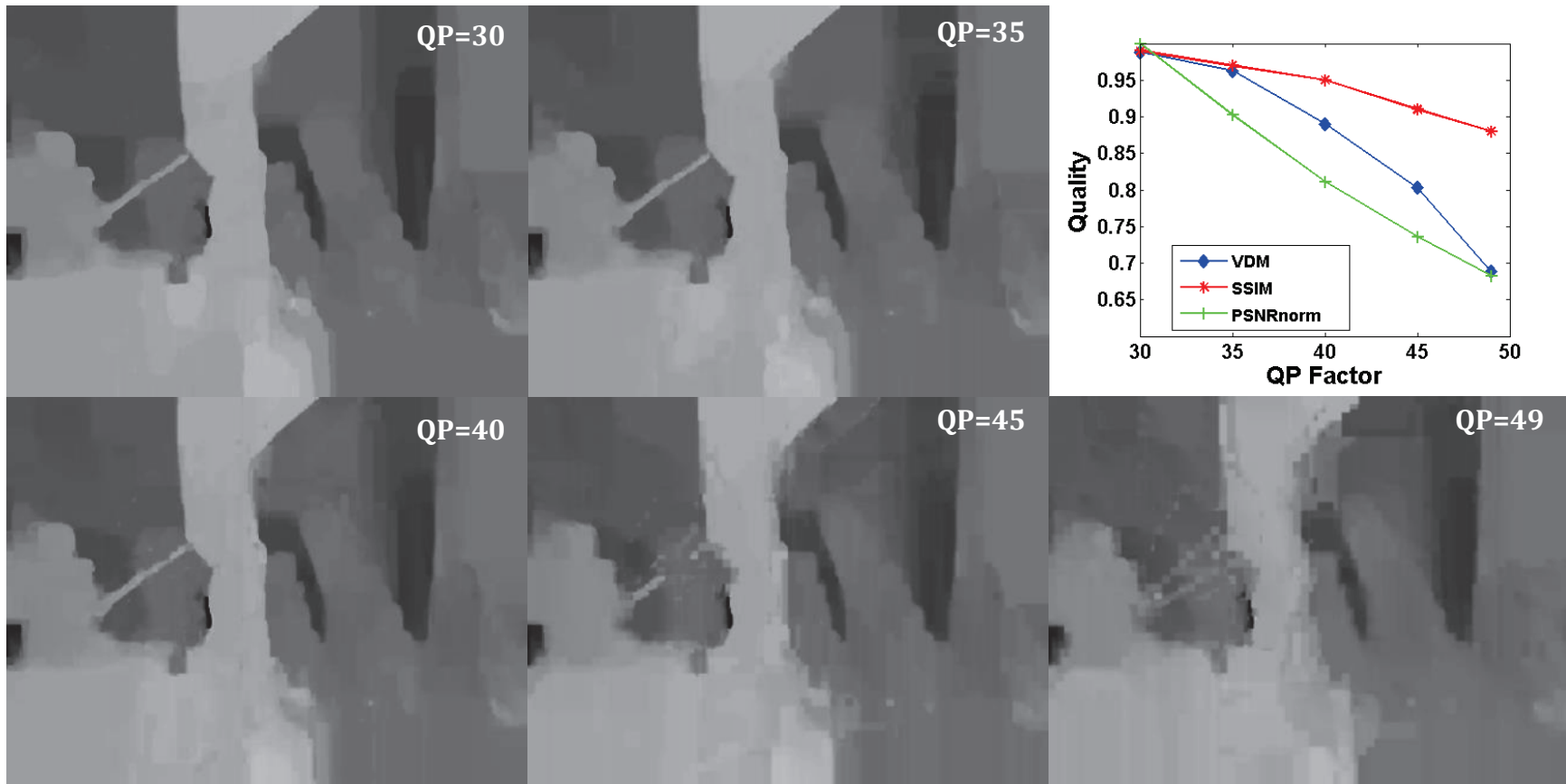

VDM versus SSIM and PSNR

Lovebirds

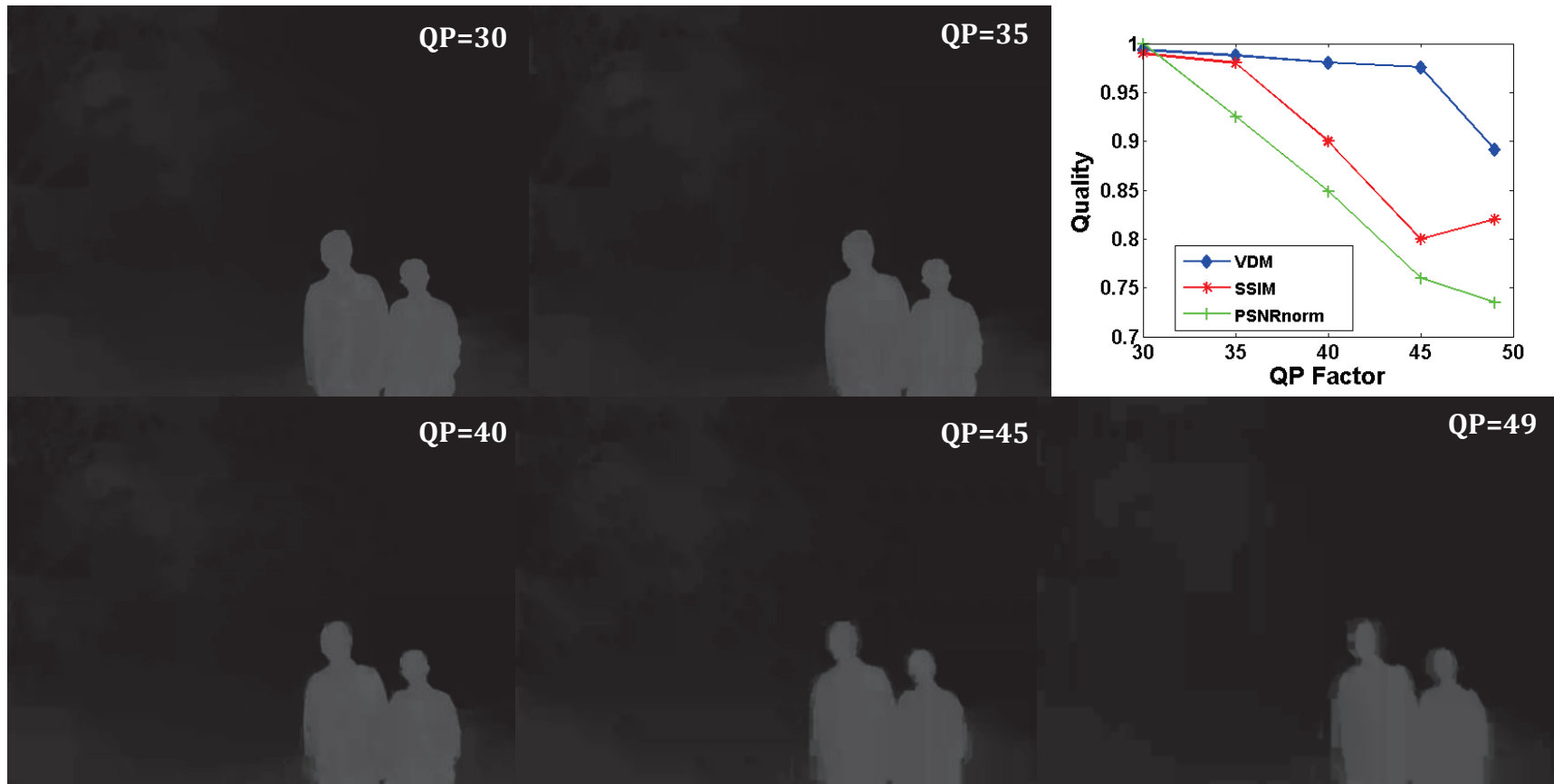

VDM versus SSIM and PSNR

Pantomime

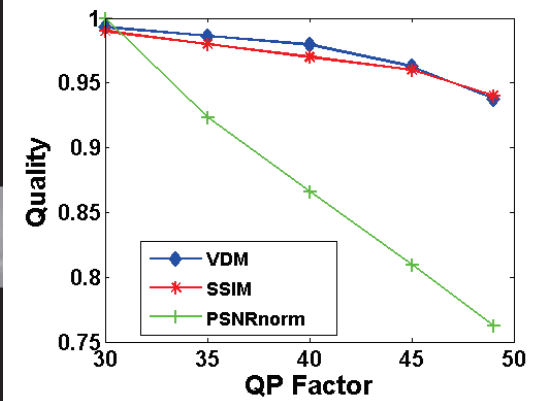

Encoding Mode Selection

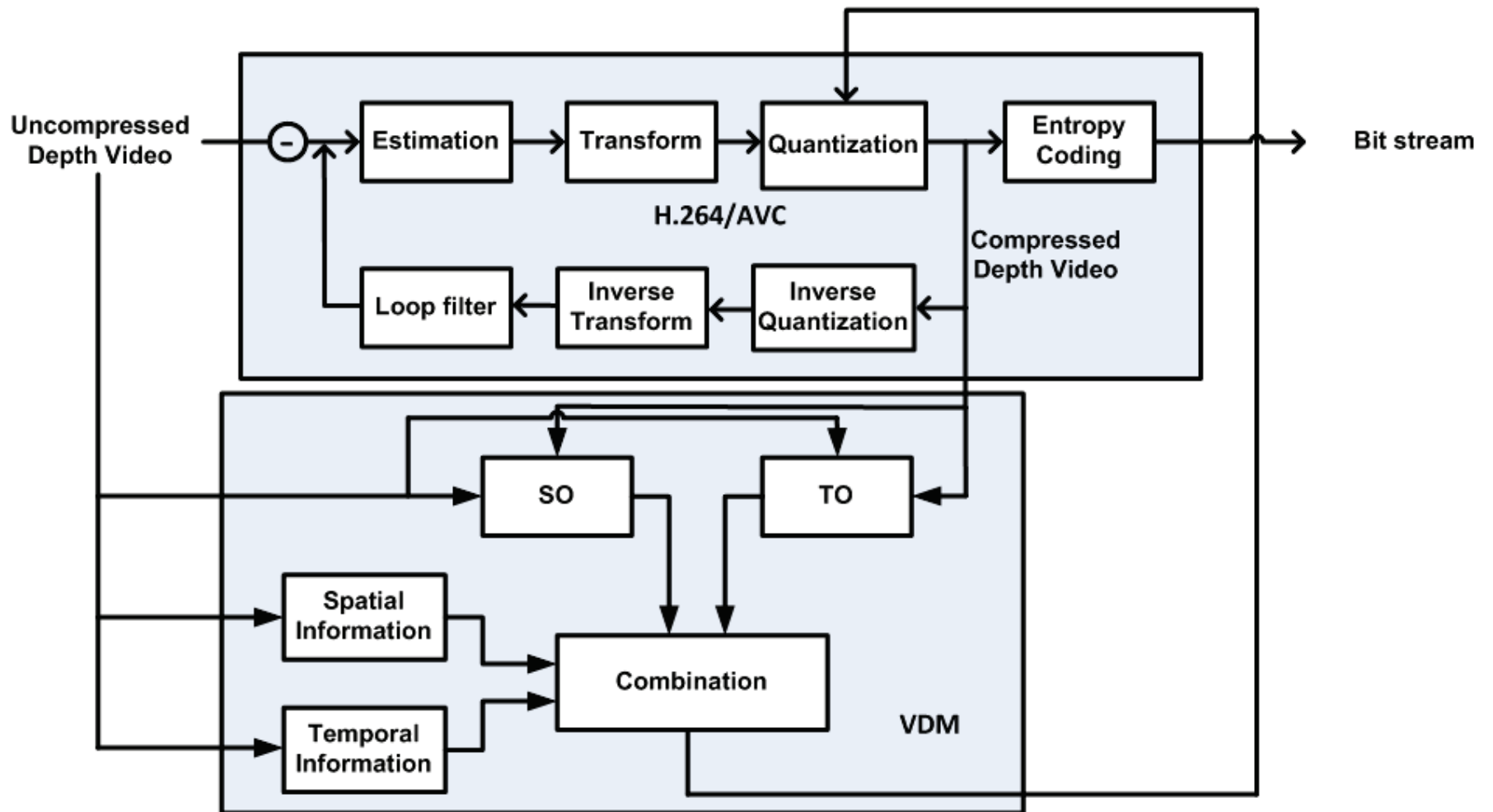

Rate Distortion Analysis

Balloons



BALLOONS	Without RDO	Standard RDO	VDM based RDO
Bitrate	93.58	48.79	42.53
PSNR	36.08	33.51	32.49
SSIM	0.96	0.94	0.93

WRDO: Synthesized Video without Rate Distortion Optimization

SRDO: Synthesized Video with Standard Rate Distortion Optimization

VDM: Synthesized Video with VDM-based Rate Distortion Optimization



Rate Distortion Analysis Champagne Tower



CHAMPAGNE TOWER	Without RDO	Standard RDO	VDM based RDO
Bitrate	56.58	50.45	26.45
PSNR	39.73	38.78	35.45
SSIM	0.98	0.98	0.95



Rate Distortion Analysis

Kendo



KENDO	Without RDO	Standard RDO	VDM based RDO
Bitrate	153.84	57.83	67.76
PSNR	35.11	30.63	30.96
SSIM	0.95	0.89	0.90



Rate Distortion Analysis

Lovebirds



LOVEBIRDS	Without RDO	Standard RDO	VDM based RDO
Bitrate	37.66	49.55	19.47
PSNR	39.56	41.40	34.92
SSIM	0.90	0.97	0.81



Rate Distortion Analysis

Pantomime



PANTOMIME	Without RDO	Standard RDO	VDM based RDO
Bitrate	71.81	48.86	38.75
PSNR	39.37	36.70	35.90
SSIM	0.97	0.95	0.95



Conclusion

Bit rate (kbits/sec)

Depth Sequences	WRDO	SRDO	VDM
Balloons	93.58	48.79	42.53
Champagne	56.58	50.45	26.45
Kendo	153.84	57.83	67.76
Lovebird	37.66	49.55	19.47
Pantomime	71.81	48.86	38.75
AVERAGE	82.69	54.10	38.99

PSNR (dB)

SSIM

Depth Sequences	PSNR (dB)			SSIM		
	WRDO	SRDO	VDM	WRDO	SRDO	VDM
Balloons	36.08	33.51	32.49	0.96	0.94	0.93
Champagne	39.73	38.78	35.45	0.98	0.98	0.95
Kendo	35.11	30.63	30.96	0.95	0.89	0.90
Lovebird	39.56	41.40	34.92	0.90	0.97	0.81
Pantomime	39.37	36.70	35.90	0.97	0.95	0.95
AVERAGE	37.97	36.20	33.94	0.95	0.95	0.91

