

Reference

American National Standard

Adopted for Use by
the Federal Government



FIPS PUB 50

See Notice on Inside
Front Cover

recorded magnetic tape
for information interchange
(6250 CPI, group-coded recording)

X3.54-1976

JK
468
.ASA3
no. 50
1976



american national standards institute, inc.
1430 broadway, new york, new york 10018

This standard has been adopted for Federal Government use.

Details concerning its use within the Federal Government are contained in FIPS PUB 50, Recorded Magnetic Tape for Information Interchange, 6250 cpi (246 cpmm), Group Coded Recording. For a complete list of the publications available in the Federal Information Processing Standards Series, write to the Office of Technical Information and Publications, National Bureau of Standards, Washington, D.C. 20234.

Remove

this tab

before mailing



Remove

this tab

before mailing



National Bureau of Standards

DEC 7 1978

NOT ACC

JK 468

.A843

no. 50

1977

ANSI®
X3.54-1976

**American National Standard
Recorded Magnetic Tape
for Information Interchange
(6250 CPI, Group-Coded Recording)**

Secretariat

Computer and Business Equipment Manufacturers Association

Approved June 10, 1976

American National Standards Institute, Inc

American National Standard

An American National Standard implies a consensus of those substantially concerned with its scope and provisions. An American National Standard is intended as a guide to aid the manufacturer, the consumer, and the general public. The existence of an American National Standard does not in any respect preclude anyone, whether he has approved the standard or not, from manufacturing, marketing, purchasing, or using products, processes, or procedures not conforming to the standard. American National Standards are subject to periodic review and users are cautioned to obtain the latest editions.

CAUTION NOTICE: This American National Standard may be revised or withdrawn at any time. The procedures of the American National Standards Institute require that action be taken to reaffirm, revise, or withdraw this standard no later than five years from the date of publication. Purchasers of American National Standards may receive current information on all standards by calling or writing the American National Standards Institute.

Published by

**American National Standards Institute
1430 Broadway, New York, New York 10018**

Copyright © 1976 by American National Standards Institute, Inc
All rights reserved.

No part of this publication may be reproduced in any form,
in an electronic retrieval system or otherwise, without
the prior written permission of the publisher.

Printed in the United States of America

P7M1277/525

Foreword

(This Foreword is not a part of American National Standard Recorded Magnetic Tape for Information Interchange (6250 CPI, Group-Coded Recording), X3.54-1976.)

This standard presents format and recording requirements for 1/2-inch, 9-track magnetic tape to be used for information interchange among information processing systems, communication systems, and associated equipment utilizing the American National Standard Code for Information Interchange, X3.4-1968 (ASCII). This standard deals solely with recording on magnetic tape and complements American National Standard Unrecorded Magnetic Tape for Information Interchange (9-Track 200 and 800 CPI, NRZI, and 1600 CPI, PE), X3.40-1976.

The X3B1 Subcommittee on Magnetic Tape, which developed this standard, consists of a number of experienced and qualified specialists on recording of digital information on magnetic tape. In the development of this standard careful consideration was given to current practices, existing equipment and supplies, and the broadest possible acceptance, and to providing a basis for future improvement in the use of the medium.

This standard was approved as an American National Standard by ANSI on June 10, 1976.

Suggestions for improvement of this standard will be welcome. They should be sent to the American National Standards Institute, 1430 Broadway, New York, N.Y. 10018.

This standard was processed and approved for submittal to ANSI by American National Standards Committee on Computers and Information Processing, X3. Committee approval of the standard does not necessarily imply that all committee members voted for its approval. At the time it approved this standard, the X3 Committee had the following members:

J. F. Auwaerter, Chairman
R. M. Brown, Vice-Chairman
W. F. Hanrahan, Secretary

<i>Organization Represented</i>	<i>Name of Representative</i>
Addressograph Multigraph Corporation	A. C. Brown D. Anderson (Alt)
Air Transport Association	F. C. White C. Hart (Alt)
American Library Association	J. R. Rizzolo J. C. Kountz (Alt) M. S. Malinconico (Alt)
American Nuclear Society	D. R. Vondy M. K. Butler (Alt)
American Society for Information Science	M. C. Kepplinger
Association for Computing Machinery	P. Skelly J. A. N. Lee (Alt) H. E. Thiess (Alt)
Association for Educational Data Systems	A. K. Swanson
Association of American Railroads	R. A. Petrash
Association of Computer Programmers and Analysts.	L. A. Ruh M. A. Morris, Jr (Alt)
Association of Data Processing Service Organizations	J. B. Christiansen
Burroughs Corporation.	E. Lohse J. S. Foley (Alt) J. F. Kalbach (Alt)
Computer Industry Association	N. J. Ream A. G. W. Biddle (Alt)
Control Data Corporation	C. E. Cooper G. I. Williams (Alt)
Data Processing Management Association	A. E. Dubnow D. W. Sanford (Alt)
Datapoint Corporation	V. D. Poor H. W. Swanson (Alt)
Digital Equipment Corporation	P. White A. R. Kent (Alt)
Edison Electric Institute	S. P. Shrivastava J. L. Weiser (Alt)

<i>Organization Represented</i>	<i>Name of Representative</i>
General Services Administration	D. L. Shoemaker M. L. Burris (Alt)
GUIDE International	T. E. Wiese B. R. Nelson (Alt) D. Stanford (Alt)
Honeywell Information Systems, Inc.	T. J. McNamara E. H. Clamons (Alt)
Institute of Electrical and Electronics Engineers, Communications Society	(Representation Vacant)
Institute of Electrical and Electronics Engineers, Computer Society	R. L. Curtis T. Feng (Alt)
International Business Machines Corporation	L. Robinson W. F. McClelland (Alt)
Joint Users Group	T. E. Wiese L. Rodgers (Alt)
Life Office Management Association	R. Ricketts J. F. Foley (Alt) E. J. Jowdy (Alt)
Litton Industries	I. Danowitz
National Association of State Information Systems	G. H. Roehm J. L. Lewis (Alt) G. I. Theis (Alt)
National Bureau of Standards	H. S. White, Jr R. E. Rountree (Alt)
National Communications Systems	M. L. Cain G. W. White (Alt)
National Machine Tool Builders' Association	O. A. Rodriques
NCR Corporation	R. J. Mindlin A. R. Daniels (Alt) T. W. Kern (Alt)
Olivetti Corporation of America	E. J. Almquist
Pitney Bowes, Inc	R. H. Fenn E. T. Warzecha (Alt)
Printing Industries of America	N. Scharpf E. Masten (Alt)
Recognition Equipment, Inc	H. F. Schantz W. E. Viering (Alt)
Sanders Associates, Inc	A. L. Goldstein T. H. Buchert (Alt)
Scientific Apparatus Makers Association	A. Savitsky J. E. French (Alt)
SHARE Inc	T. B. Steel, Jr E. Brubaker (Alt)
Society of Certified Data Processors	T. M. Kurihara A. E. Dubnow (Alt)
Telephone Group	V. N. Vaughan, Jr J. C. Nelson (Alt) P. G. Wray (Alt)
3M Company	R. C. Smith
UNIVAC, Division of Sperry Rand Corporation	M. W. Bass C. D. Card (Alt)
U.S. Department of Defense	W. L. McGreer W. B. Rinehuls (Alt) W. B. Robertson (Alt)
U.S. Department of Health, Education and Welfare	W. R. McPherson, Jr M. A. Evans (Alt)
VIM (CDC 6000 Users Group)	S. W. White M. R. Speers (Alt)
Xerox Corporation	J. L. Wheeler A. R. Machell (Alt)

Subcommittee X3B1 on Magnetic Tape, which developed this standard, had the following members:

J. S. Zajaczkowski, Chairman

A. Audeh	R. McKenna
R. Bartholomew	F. Maculoso
E. R. Bessenfelder	A. B. Manildi
R. E. Braun	J. Morneault
J. C. Breese	D. P. Norman
J. G. Bullock	J. L. O'Neal
W. H. Bunker	R. F. Pariury
F. H. Burgess	R. Pembroke
A. J. Burkhardt	W. B. Poland
J. Campbell	J. Pomian
J. U. Chesnutt	L. H. Rice
W. Conroy	W. Rivet
P. A. Cosby	J. A. Rodrigues
R. Dienst	R. Rogers
J. J. Fiori	K. Rohde
D. Fowler	A. Roth
R. Fussell	H. W. Sallet
S. B. Geller	R. I. Silva
M. Gray	J. Small
S. Grossman	J. Smith
M. Grundtner	R. C. Smith
D. Haddick	G. Sovereign
J. W. Heermans	R. T. Steinbrenner
H. O. Hemdal	A. Stenfors
M. Hogan	G. Suechting
C. L. Holder	D. Terry
C. E. Holler	V. L. Thompson
H. Hutchinson	D. F. Tomisak
A. Kronfeld	R. N. Tullos
T. C. Lambert	J. E. Williams
N. A. Leifer	R. S. Wooldridge
M. Lohrenz	S. Zalewa

Contents

SECTION	PAGE
1. Scope	9
2. Definitions	9
3. Recording Area Markers	10
4. Recording	10
4.1 Method	10
4.2 Density of Recording	10
4.3 Flux Reversal Spacing	11
4.4 Total Character Skew	12
4.5 Standard Reference Amplitude	12
4.6 Signal Amplitude	12
4.7 Erase	12
5. Format	12
5.1 Track Format	12
5.2 Track Dimensions	12
5.3 Reference Edge	12
5.4 Track Identification	12
5.5 Block Length	12
5.6 Preamble	12
5.7 Postamble	12
5.8 Density Identification Area	13
5.9 Automatic Read Amplification Burst	13
5.10 Interblock Gap	13
5.11 Tape Mark	13
5.12 Resync Burst	13
5.13 Storage Group	15
5.14 Mark 1 Control Subgroup	15
5.15 Mark 2 Control Subgroup	15
5.16 End Mark	15
5.17 Sync Control Subgroup	15
5.18 Terminator Control Subgroup (TERM)	15
5.19 Second Control Subgroup	15
5.20 Residual Character	15
5.21 Data Group	15
5.22 Residual Data Group	15
5.23 CRC Data Group	16
6. Check Characters	16
6.1 Introduction	16
6.2 ECC Character	16
6.3 Auxiliary CRC Character	16
6.4 CRC Character	17
7. Revision of American National Standards Referred to in This Document	17
Tables	
Table 1 Data Group to Storage Group Example	15
Table 2 Record Code Values	16
Figures	
Fig. 1 Usable Recording Area	11
Fig. 2 Recording Format (6250 CPI)	13
Fig. 3 Format	14

Appendixes

Appendix A Design Considerations	18
A1. Introduction	18
A2. Specification Support	18
A3. Additional Considerations	19

Appendix B Measurement of Flux Reversal Spacing	20
B1. Procedure	20
B2. Instrumentation	20
B3. Reference Transitions	20
B4. Head	20
B5. Explanation	20

Table B1 Worst-Case Test Patterns	20
---	----

Figures

Fig. B1 Flux Reversal Spacing Measurement Instrumentation	21
Fig. B2 Reference Transitions	21

Appendix C Determination of Rate of Change	22
C1. Definition of Rate of Change	22
C2. Instrumentation	22
C3. Explanation	22

Figures

Fig. C1 Parameters for Rate-of-Change Determination	22
Fig. C2 Instrumentation for Measuring Rate of Change	23

American National Standard Recorded Magnetic Tape for Information Interchange (6250 CPI, Group-Coded Recording)

1. Scope

This standard is intended to provide format and recording specifications for 1/2-inch, 9-track magnetic tape to be used for information interchange among information processing systems, communication systems, and associated equipment utilizing the American National Standard Code for Information Interchange, X3.4-1968 (ASCII). This standard deals solely with recording on magnetic tape and supports and complements American National Standard Unrecorded Magnetic Tape for Information Interchange (9-Track 200 and 800 CPI, NRZI, and 1600 CPI, PE), X3.40-1976, the following sections of which are dealt with in detail: general requirements, definitions, tape physical and magnetic requirements, tape reel requirements, and write-enable ring. Compliance with the standard for unrecorded tape is a requirement for information interchange.

CAUTION NOTICE: The user's attention is called to the possibility that compliance with this standard may require use of an invention covered by patent rights.

By publication of this standard, no position is taken with respect to the validity of this claim or of any patent rights in connection therewith. The patent holder has, however, filed a statement of willingness to grant a license under these rights on reasonable and nondiscriminatory terms and conditions, to applicants desiring to obtain such a license. Details may be obtained from the publisher.

No representation or warranty is made or implied that this is the only license that may be required to avoid infringement in the use of this standard.

2. Definitions

alternate record code. Five bits along any track representing encoded 4 bits of data, padding characters, check characters, residual characters, or a combination of these characters, on tape.

automatic read amplification (ARA) burst. A string of bits in all tracks for setting up the amplifiers.

automatic read amplification (ARA) identification (ID) character. A special control block used at the end of the ARA burst to identify the ARA burst when reading backward to the load point.

auxiliary cyclic redundancy check (CRC) character. A CRC character usable for error-detection purposes.

beginning-of-tape (BOT) marker. A photoreflective marker placed on the tape for the purpose of indicating the beginning of the permissible recording area.

block. A group of contiguous recorded characters considered and transported as a unit containing one or more logical records. Blocks are separated by an inter-block gap.

control subgroups. Those special subgroups of characters that (except for the subgroup containing the last character) have sets of identical control five-serial-bit values in the nine tracks.

End Mark. A subgroup used to demark the residual area group. When the media movement is in a forward direction, it denotes that the next group is the residual group.

Mark 1. A subgroup used to demark data groups from other control subgroups. When the media movement is in a forward direction, it denotes the onset of data groups.

Mark 2. A subgroup used to demark data groups from other control subgroups. When the media movement is in a forward direction, it denotes the onset of other control subgroups.

second control subgroups. The second subgroup and next to last subgroup of a record.

sync control subgroup. A subgroup used to indicate recorded frequency and phase to allow synchronization of the variable-frequency clock (VFC).

terminator control subgroups. The first subgroup and last subgroup of a record.

cyclic redundancy check (CRC) characters. Characters usable for error detection.

cyclic redundancy check (CRC) data group. A specially formatted data group containing one of the CRC characters, the residual character, and an error-correcting code (ECC) character.

data group. Seven data characters plus an ECC character accumulated as a group prior to the record code value translation.

density. The nominal distribution per unit length of recorded information, usually expressed in characters per inch.

end-of-tape (EOT) marker. A photoreflective marker placed on the tape for the purpose of indicating the ending of the permissible recording area.

error-correcting code (ECC) character. A special character usable for error detection and correction.

flux reversal position. The point that exhibits the maximum free-space surface flux density normal to the tape surface.

flux spacing. The space between successive flux transitions.

group-coded recording (GCR). A recording technique that collects groups of characters and encodes them prior to putting them on tape.

interblock gap. A dc-erased section of tape separating blocks of information.

last character. The last character in each block, which restores magnetic remanence in all tracks to the dc erase polarity.

postamble. Groups of special signals recorded at the end of a block on tape for the purpose of electronic synchronization.

preamble. Groups of special signals recorded at the beginning of each block on tape for the purpose of electronic synchronization.

record code. The coded representation of data, padding characters, check characters, and residual characters on tape.

residual character. The character that occupies the seventh group position of the CRC data group and contains two data byte counts, one to modulo 7 and one to modulo 32.

residual group. The group that contains the extra characters (the remainder of the number of characters divided by 7), an auxiliary CRC character, and an ECC character. Each such extra character is a residuum character.

Resync Burst. A set of control subgroups identifying format resynchronization points in a block. It is intended that read-back circuits be able to resynchronize operations when sensing such bursts.

skew. The deviation of bits within a tape character from the intended or ideal placement, which is perpendicular to the reference edge.

storage group. Ten characters created from the data group via the record code value translation.

subgroup. One-half of a data or storage group. See *control subgroups*.

Tape Mark. A special control block recorded on magnetic tape to serve as a separator between files and file labels.

total character skew. The deviation, during reading, from time coincidence of the bits within a recorded character.

3. Recording Area Markers

Each reel of tape shall be furnished with two photoreflective markers, beginning-of-tape (BOT) and end-of-tape (EOT), as shown in Fig. 1.

4. Recording

4.1 Method. The recording method shall be NRZI (non-return to zero, change on ones). A "1" bit is represented by a reversal of magnetic flux polarity.

4.2 Density of Recording

4.2.1 The density of recording on tape shall be 6250 characters per inch. The nominal maximum flux reversal rate at this density is 9042 flux reversals per inch (frpi). However, the nominal flux reversal rate (1010 pattern) for the following measurements is 4521 frpi. The flux reversal spacing at this rate shall be 221.2 micrometers (μin), subject to the variations given in 4.2.2 through 4.2.4.

4.2.2 Long-term average (static) flux reversal spacing shall be within $\pm 4\%$ of the nominal spacing. This average shall be measured over a minimum of 500 000 flux reversal intervals.

4.2.3 Short-term (dynamic) flux reversal spacing shall be within $\pm 6\%$ of the long-term average. The short-term spacing is the average over two contiguous flux reversal intervals.

4.2.4 The rate of change of the short-term flux

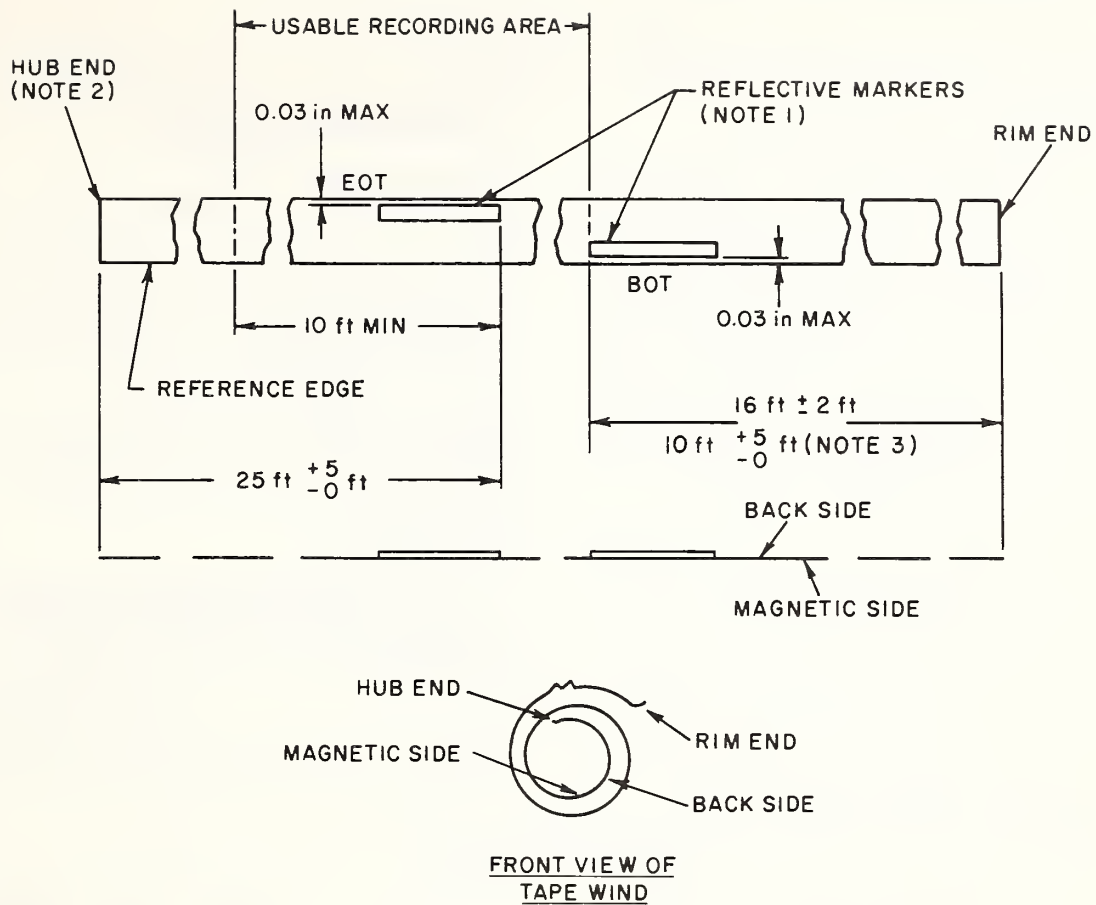

Legend

- BOT: Beginning-of-tape marker
- EOT: End-of-tape marker

NOTES:

- (1) Photoreflexive markers shall not protrude beyond the edge of the tape and shall be free of wrinkles and excessive adhesive. Marker dimensions: length, $1.1 \text{ inch} \pm 0.2 \text{ inch}$; width, $0.19 \text{ inch} \pm 0.02 \text{ inch}$; thickness, 0.0008 inch maximum.
- (2) Tape shall not be attached to the hub.
- (3) Two values for placement of the BOT marker are given, both of which can be handled by most tape units. The indicated value of $16 \text{ feet} \pm 2 \text{ feet}$ is the current specified dimension.

Fig. 1
Usable Recording Area

spacing shall not exceed 0.26% per flux reversal interval.

4.3 Flux Reversal Spacing

- 4.3.1 The maximum deviation of flux reversal spacing shall include the effects described in 4.2.
- 4.3.2 The average spacing between successive flux transitions at 9042 frpi shall not differ by more than 2%.
- 4.3.3 Flux reversal deviations shall be determined by their relationship to specified reference transitions.

4.3.4 The maximum average deviation of flux transitions on either side of the reference flux transitions shall not exceed $\pm 28\%$ of the average flux reversal spacing at 9042 frpi.

4.3.5 The average spacing between reference flux transitions on the specified pattern shall not deviate from the computed average by more than $\pm 6\%$.

4.3.6 The magnetic tape to be used for interchange shall meet the conditions of 4.3.2 through 4.3.5 when tested on a reference read chain under the conditions specified in Appendix B.

4.4 Total Character Skew. No data bit in a character shall be displaced more than 664 μ in from any other data bit in the same tape character when measured in a direction parallel to the reference edge.

4.5 Standard Reference Amplitude.¹ The Standard Reference Amplitude is the average peak-to-peak output signal amplitude derived from the National Bureau of Standards (NBS) Amplitude Reference Tape (SRM 3200) on a measurement system at the density of 3200 frpi and the recording current of $1.8 \times I_r$. The signal amplitude shall be averaged over a minimum of 4000 flux reversals. The Standard Reference Current (I_r) is the minimum current applied to the Amplitude Reference Tape that causes an output signal amplitude equal to 95% of the maximum output signal.

4.6 Signal Amplitude¹

4.6.1 Average Signal Amplitude. The average peak-to-peak signal amplitude of an interchanged tape at 3200 frpi shall deviate no more than + 50%, - 35% from the Standard Reference Amplitude. Averaging shall be done over a minimum of 4000 flux reversals, which for the interchange tape may be segmented into groups of 70 flux reversals each.

4.6.2 1600-frpi Signal Amplitude. The peak-to-peak signal amplitude shall be less than 3 times the Standard Reference Amplitude.

4.6.3 Minimum Signal Amplitude. An interchanged tape shall contain no adjacent flux reversals whose peak-to-peak signal amplitude is less than 0.2 times the Standard Reference Amplitude.

4.7 Erase¹

4.7.1 Erase Direction. The tape shall be magnetized so that the rim end of the tape is a north-seeking pole.

4.7.2 Erase Width. The full width of the tape is dc-erased in the direction specified in 4.7.1.

4.7.3 Erase Function. The erase function, whether by the write head or the erase head, shall ensure that the level of the read-back signal amplitude is below 4% of the Standard Reference Amplitude at 3200 frpi.

4.7.4 Erase Head. The erase head shall be capable of erasing other densities (200, 800, 1600) so that the read-back signal is below 4% of the Standard Reference Amplitude at 3200 frpi.

¹ Most tapes that meet the 3200-frpi requirements enumerated in 4.5, 4.6, and 4.7 will interchange when written and read in the GCR mode. Further delineation of amplitude requirements with respect to 9042 frpi are under consideration by the X3 Committee and the National Bureau of Standards and will be published when available. Interchange parties should be cautioned that the tape subsystem should be compatible with respect to the signal amplitude on the interchange tape.

5. Format

5.1 Track Format. The track format shall consist of nine parallel tracks (see Fig. 2 and 3).

5.2 Track Dimensions

5.2.1 Track width on tape shall be 0.043 inch minimum.

5.2.2 The centerline distance between tracks shall be 0.055 inch nominal.

5.2.3 The centerline of track 1 shall be 0.029 inch \pm 0.003 inch from the reference edge.

5.3 Reference Edge. The reference edge of the tape shall be the top edge when viewing the oxide-coated side of the tape with the rim end of the tape to the observer's right.

5.4 Track Identification

5.4.1 Tracks shall be numbered consecutively, beginning at the reference edge with track 1, and assigned as follows:

Track:	1	2	3	4	5	6	7	8	9
Environment:	E3	E1	E5	P	E6	E7	E8	E2	E4
Binary weight:	2 ²	2 ⁰	2 ⁴	P	2 ⁵	2 ⁶	2 ⁷	2 ¹	2 ³
ASCII bits:	b ₃	b ₁	b ₅	P	b ₆	b ₇	Z	b ₂	b ₄

5.4.2 Bits b₁–b₇ correspond to the bit assignments in ASCII.

5.4.3 Bit P is the parity bit. Character parity is odd in data subgroups; it can be either odd or even on tape.

5.4.4 Bit Z shall be zero and treated as a bit of higher order than the ASCII bits.

5.5 Block Length

5.5.1 The data portion of a block shall contain a minimum of 18 ASCII characters.

5.5.2 The data portion of a block shall contain a maximum of 2048 ASCII characters. However, with the agreement of the interchange parties, larger blocks may be used.

5.6 Preamble. Preceding data in each block, a preamble shall be written consisting of 80 characters, of which the first and second control subgroups are 10101 and 01111, respectively, followed by fourteen 11111 control subgroups in all tracks.

5.7 Postamble. Following data, the residual group, the CRC data group, and the Mark 2, a postamble shall be written consisting of 80 characters, of which the first 14 subgroups are all "ones" in all tracks followed by 11110 and 1010L in all tracks. (The L character is the last character.)

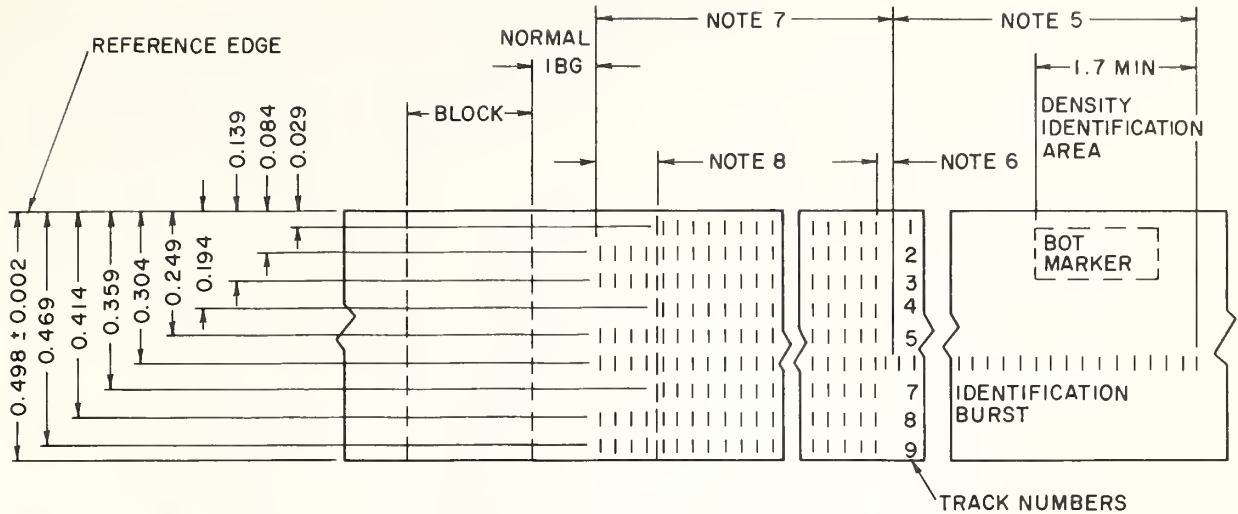

NOTES:

- (1) Tape is shown in 6250 mode, oxide side up.
- (2) All dimensions are given in inches.
- (3) Track placement tolerance is ± 0.003 for each track.
- (4) Tape to be fully saturated in the erase direction in the interblock gap and the ID area.
- (5) ID burst (see 5.8).
- (6) Undefined gap (see 5.9).
- (7) ARA burst (see 5.9).
- (8) ARA ID characters (see 5.9).

Fig. 2
Recording Format (6250 CPI)

5.8 Density Identification Area. The GCR recording method shall be identified by a burst of the recording at the BOT marker. This burst shall be in the PE frequency range on track 6 and erasure on all other tracks. The ID burst shall begin 1.7 inches minimum before the trailing edge of the BOT marker and continue past the trailing edge of the BOT marker.

5.9 Automatic Read Amplification Burst. Immediately following the ID burst, there is an ARA burst (all ones in all tracks), which is separated from the ID burst by an undefined gap. This burst of ones shall be placed as follows: It shall begin no sooner than 1.5 inches and no later than 4.3 inches as measured from the leading edge of the BOT marker. It shall end no sooner than 9.5 inches and no later than 11.5 inches as measured from the leading edge of the BOT marker. Appended to the end of the ones burst is an ID character consisting of ones in tracks, 2, 3, 5, 6, 8, and 9, and erasure in tracks 1, 4, and 7. This ID character shall be approximately 2 inches long. (At least a contiguous 1/4 inch of this 2-inch length shall be error-free in all tracks at once.) There is a normal interblock gap (IBG) between the ARA ID character and the first data block.

5.10 Interblock Gap. In addition to preambles and postambles, the interblock gap shall be as follows:

- (1) Nominal: 0.3 inch
- (2) Minimum: 0.28 inch
- (3) Maximum: 15 feet

5.11 Tape Mark. The End-of-File information is marked by a Tape Mark, a special block written only by the Write Tape Mark command. One or more files may be written on a reel of tape.

The Tape Mark is specified as 250 to 400 flux changes, all "ones," at 9042 frpi in tracks 2, 5, 8, 1, 4, and 7, and no recording in tracks 3, 6, and 9.

5.12 Resync Burst

5.12.1 The Resync Burst consists of a Mark 2, two sync, and a Mark 1 control subgroup. This burst is interleaved in the block every 158 data groups. As a result, there are 158 data groups bracketed by a Mark 1 and a Mark 2 control subgroup (see Fig. 3).

5.12.2 End data at the expected resync location. If the number of data characters remaining in the block after the 158th data group is less than seven, there will be an End Mark control subgroup instead of a Resync Burst.

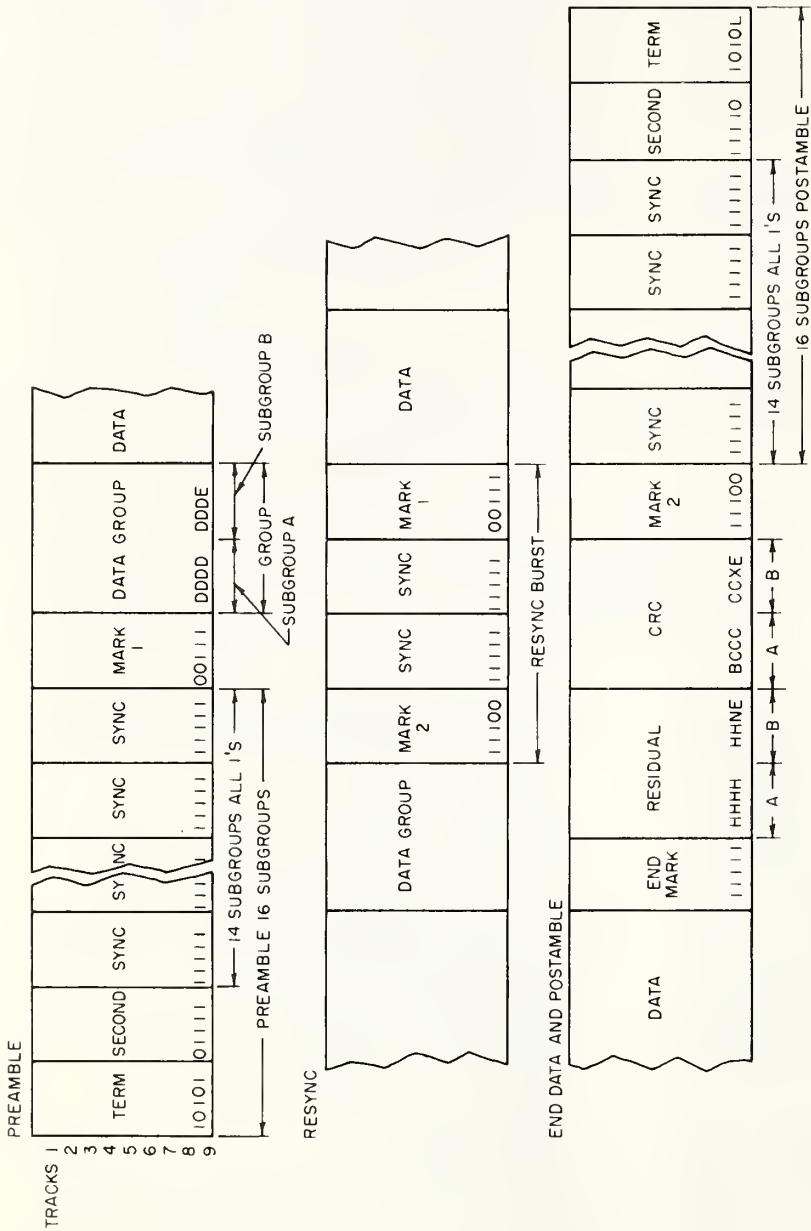

Legend:

- D: Data characters
- H: Pad or data character
- X: Residual character
- E: ECC character
- C: CRC character
- N: Auxiliary CRC character
- L: Last character
- B: CRC or pad character

NOTE: This figure portrays the format prior to the encoding of the data, residual, and CRC groups in accordance with Table 2. The control subgroups are recorded on tape as shown and described.

Fig. 3
Format

Table 1
Data Group to Storage Group Example

Physical Tracks	Data Group				Storage Group													
	Data Subgroup "A"		Data Subgroup "B"		Storage Subgroup "A"		Storage Subgroup "B"											
1	D	D	D	D	D	D	D	E	X	X	X	X	X	X	X	X	X	X
2	D	D	D	D	D	D	D	E	X	X	X	X	X	X	X	X	X	X
3	D	D	D	D	D	D	D	E	X	X	X	X	X	X	X	X	X	X
4	P	P	P	P	P	P	P	P	X	X	X	X	X	X	X	X	X	X
5	D	D	D	D	D	D	D	E	X	X	X	X	X	X	X	X	X	X
6	D	D	D	D	D	D	D	E	X	X	X	X	X	X	X	X	X	X
7	D	D	D	D	D	D	D	E	X	X	X	X	X	X	X	X	X	X
8	D	D	D	D	D	D	D	E	X	X	X	X	X	X	X	X	X	X
9	D	D	D	D	D	D	D	E	X	X	X	X	X	X	X	X	X	X
Group Positions:	1	2	3	4	5	6	7	8	1	2	3	4	5	6	7	8	9	10

NOTE: Tape is recorded in 9-bit characters (across tape) by 10 bits long. This 90-bit group is called a "storage group." Prior to the record code values conversion there are eight linear bits, made up of seven data bits and one check bit. This group of 72 bits is called a "data group." The 4-bit and 5-bit combinations are called "subgroups."

5.13 Storage Group. The ten record characters representing one data group are illustrated in Table 1. The lowest-numbered character position is closest to BOT.

5.14 Mark 1 Control Subgroup. The Mark 1 control subgroup is one set of nine parallel 5-bit serial values, 00111 in the respective tracks.

5.15 Mark 2 Control Subgroup. The Mark 2 control subgroup is one set of nine parallel 5-bit serial values, 11100 in the respective tracks.

5.16 End Mark. The End Mark control subgroup is one set of nine parallel 5-bit serial values, 11111 in the respective tracks.

5.17 Sync Control Subgroup. The sync control subgroup is one set of nine parallel 5-bit serial values, 11111 in the respective tracks.

5.18 Terminator Control Subgroup (TERM). The terminator control subgroup is one set of nine parallel 5-bit serial values of 10101 in the respective tracks located at the BOT end of each block and 1010L at the EOT end of each block, where L represents a bit of a last character that restores the magnetic remanence to the erase state.

5.19 Second Control Subgroup. The second control subgroup is one set of nine parallel 5-bit serial values of 01111 in the respective tracks for the BOT end of the block and 11110 for the EOT end of the block interleaved between the respective terminator control subgroups and the sync control subgroups.

5.20 Residual Character. The track assignment for the residual character is as follows:

	<u>Mod 32</u>				<u>Mod 7</u>			<u>Mod 32</u>	
Binary value:	2 ²	2 ⁰	2 ⁴	P	2 ⁰	2 ¹	2 ²	2 ¹	2 ³
Tracks:	1	2	3	4	5	6	7	8	9

where

Valid mod 7 binary counts are 000 to 110

Valid mod 32 binary counts are 00000 to 11111

Mod 7 count equals the binary value of the remainder of the number of characters in the record divided by 7

Mod 32 count equals the binary value of the remainder less one of the number of characters in the record divided by 32

5.21 Data Group. The data group consists of seven data characters plus an ECC character arranged as follows:

	<u>Subgroup A</u>				<u>Subgroup B</u>			
Group position:	1	2	3	4	5	6	7	8

where

Positions 1-7 contain data characters

Position 8 contains the ECC character generated per 6.2 (see Tables 1 and 2)

5.22 Residual Data Group. The residual data group positions are as follows:

(1) Group positions 1-6 contain residuum data characters or padding.

Table 2
Record Code Values

Data Values (Group Positions: 1 2 3 4 / 5 6 7 8)	Record Values (Group Positions: 1 2 3 4 5 / 6 7 8 9 10)
0000	11001
0001	11011
0010	10010
0011	10011
0100	11101
0101	10101
0110	10110
0111	10111
1000	11010
1001	01001
1010	01010
1011	01011
1100	11110
1101	01101
1110	01110
1111	01111

(2) Group position 7 contains an auxiliary CRC character.

(3) Group position 8 contains an ECC character. The residuum data characters occupy the lower-numbered positions, with the higher-numbered group positions containing padding characters of all 0's with odd parity. The group positions 1-6 may contain all padding or all data characters in accordance with the number of residuum characters modulo 7.

5.23 CRC Data Group. This specially formatted data group contains the CRC character defined in 6.4 and the residual character defined in 5.20. The group positions are as follows:

- (1) Group position 1 contains an all-0's character with odd parity or the CRC character, in accordance with 6.4.2.
- (2) Group positions 2-6 each contain the CRC character.
- (3) Group position 7 contains the residual character.
- (4) Group position 8 contains the ECC character.

6. Check Characters

6.1 Introduction. Rigorous adherence to the generator polynomial and computation for each check character is required in the design of check character generating and utilization apparatus or programs.

6.2 ECC Character

6.2.1 The eighth group position of each data group

is an 8-bit ECC character for the possible recovery of errors in that data group (see Table 1).

6.2.2 The 8 bits of each data character D_1 through D_7 are coefficients of polynomials D_1 through D_7 , respectively, as shown in Table 1. The track assignments are as follows:

Polynomial
 position: $X^1 X^4 X^7 - X^3 X^6 X^0 X^2 X^5$
 Track number: 1 2 3 4 5 6 7 8 9

Track 4 contains odd parity bit P and is not a part of the ECC character.

6.2.3 The 8 bits of the ECC character E are also coefficients of polynomial E with the same track assignments. Track 4 contains odd parity on the 8-bit character E.

6.2.4 E is computed from data polynomials D_1 through D_7 using the generator polynomial $G = X^0 + X^3 + X^4 + X^5 + X^8$ according to the following relationship:

$$E = [X^7D_1 + X^6D_2 + X^5D_3 + X^4D_4 + X^3D_5 + X^2D_6 + X^1D_7] \text{ modulo } G$$

All arithmetic operations are modulo 2.

6.3 Auxiliary CRC Character

6.3.1 At the end of each block in the residual data group, one 9-bit auxiliary CRC character is inserted into group position 7.

6.3.2 The 9 bits of each character M_1 through M_n , which includes data characters only, are coefficients of polynomials M_1 through M_n , respectively. Characters M_1 through M_n are successive data characters, with M_1 being closest to the beginning of the tape and having the following track assignments:

Polynomial
 position: $X^0 X^4 X^6 X^3 X^1 X^5 X^7 X^2 X^8$
 Track number: 1 2 3 4 5 6 7 8 9

6.3.3 The 9 bits of the auxiliary CRC character N are also coefficients of polynomial N with the same track assignments.

6.3.4 N is computed from data polynomials M_1 through M_n using the generator polynomial $G_2 = X^0 + X^2 + X^6 + X^9$ according to the following relationship (which is asymmetrical):

$$N = [X^nM_1 + X^{n-1}M_2 + \dots + X^2M_{n-1} + X^1M_n] \text{ modulo } G_2$$

All arithmetic operations are modulo 2.

The calculated auxiliary CRC character is modified by the polynomial $1 + X + X^6 + X^7 + X^8$ in an Exclusive OR arrangement with N in the corresponding bit

position; the resultant is a parity uncorrected auxiliary CRC character.

6.3.5 The auxiliary CRC character has odd parity. If the resultant of 6.3.4 has even parity, parity is changed to odd by inverting the bit corresponding to track 4.

6.4 CRC Character

6.4.1 At the end of each block in the CRC data group, a CRC character is written five or six times (see 5.23) for error-detection purposes.

6.4.2 The 9 bits of each character M_1 through M_n , including all data characters, the padding characters in the residual data group, and the auxiliary CRC character, but excluding all ECC characters, are coefficients of polynomials M_1 through M_n , respectively. Characters M_1 through M_n are successive characters, with M_1 being closest to the beginning of the tape and having the following track assignments:

Polynomial									
position:	X^6	X^8	X^4	X^0	X^3	X^2	X^1	X^7	X^5
Track number:	1	2	3	4	5	6	7	8	9

The CRC character has odd parity. If n is even, then the CRC character is repeated in each character position 1 through 6 of the CRC data group. If n is odd, then a padding character of all 0's with odd parity is character M_n and appears in byte position 1 of the CRC data group. The CRC character is repeated in each character position 2 through 6.

6.4.3 The 9 bits of the CRC character C are also coefficients of polynomial C with the same track assignments.

6.4.4 C is computed from data polynomials M_1

through M_n using the generator polynomial $G_1 = X^0 + X^3 + X^4 + X^5 + X^6 + X^9$ according to the following relationship:

$$C = [X^n M_1 + X^{n-1} M_2 + \dots + X^2 M_{n-1} + X^1 M_n] \text{ modulo } G_1$$

All arithmetic operations are modulo 2.

6.4.5 The calculated CRC character is modified by the polynomial $1 + X + X^2 + X^4 + X^6 + X^7 + X^8$, in an Exclusive OR arrangement with C in the corresponding bit positions; the resultant is the CRC character.

6.4.6 This check character is identical to the check character defined in 5.9 of American National Standard Recorded Magnetic Tape for Information Interchange (800 CPI, NRZI), X3.22-1973.

7. Revision of American National Standards Referred to in This Document

When the following American National Standards referred to in this document are superseded by a revision approved by the American National Standards Institute, Inc, the revision shall apply:

American National Standard Code for Information Interchange, X3.4-1968 (ASCII)

American National Standard Recorded Magnetic Tape for Information Interchange (800 CPI, NRZI), X3.22-1973

American National Standard Unrecorded Magnetic Tape for Information Interchange (9-Track 200 and 800 CPI, NRZI, and 1600 CPI, PE), X3.40-1976

Appendixes

(These Appendixes are not a part of American National Standard Recorded Magnetic Tape for Information Interchange (6250 CPI, Group-Coded Recording), X3.54-1976, but are included for information purposes only.)

Appendix A

Design Considerations

A1. Introduction

A1.1 This recorded magnetic tape standard is intended to implement the American National Standard Code for Information Interchange, X3.4-1968 (ASCII), on magnetic tape for interchange among information processing systems, communication systems, and associated equipment.

A1.2 A related standard, American National Standard Unrecorded Magnetic Tape for Information Interchange (9-Track 200 and 800 CPI, NRZI, and 1600 CPI, PE), X3.40-1976, has been prepared to specify unrecorded magnetic tape. Its scope includes the specification and testing of physical and magnetic properties and also the operation and storage environments, identification, control devices, and attachments.

Another related standard, American National Standard Magnetic Tape Labels for Information Interchange, X3.27-1969, specifies a standard format for blocks recorded on 1/2-inch, 9-track magnetic tape. Its scope includes the definition, content, functions, and interrelationships of blocks.

A2. Specification Support

A2.1 Tape

A2.1.1 The dimensions in this standard are for reference and for the purpose of facilitating the design and layout of the recording format.

A2.1.2 Additional signal level specifications are detailed in American National Standard X3.40-1976.

A2.1.3 The 1/2-inch tape width was selected because of its widespread current usage throughout the industry and because of the large quantity in existence.

A2.1.4 Tape length must be agreed upon by the interchange parties. The maximum length is to be limited by the requirements for reel dimensions, tape thickness, "E" value, and moment of inertia as given in American National Standard X3.40-1976.

A2.1.5 Special leaders and trailers may be attached

in order to meet special transport loading and control requirements wherever needed.

A2.1.6 The tape wind convention is specified to ensure uniformity among all users.

A2.2 Recording Area Markers. The marker type and size have been provided in this standard so that placement of BOT and EOT could be determined and set forth therein. The marker details are set forth in 3.3 of American National Standard X3.40-1976.

A2.3 Recording Method

A2.3.1 NRZI is an accepted method of recording and as implemented herein can be used at the given density.

A2.3.2 DC erase of the full width of the tape is provided to ensure that all previously recorded information is removed prior to recording new information.

A2.4 Format

A2.4.1 Number of Tracks. The 9-track format was selected for the following reasons:

(1) The de facto standard (7-track) is not capable of easily handling ASCII; a minimum of 8 tracks is desirable.

(2) The addition of the ninth track permits alternate, noninterchange uses of the same tape and equipment. (See Section A3 of this Appendix.)

A2.4.2 Track Dimensions

A2.4.2.1 The track locations (centerline of recorded data) are dimensioned from the reference edge of the tape. Tracks are numbered 1 through 9 starting at the reference edge. The track location tolerance of ± 0.003 inch is close enough to prevent undesirably wide deviation in track locations, thus allowing the widest possible read head track width. Wide read head track widths are desirable to provide adequate signal levels and enhance the freedom from defect-caused signal dropouts.

A2.4.2.2 The method of dimensioning allows equipment manufacturers to make distribution of design tolerances between the write head and the tape transport mechanism as desired.

A2.4.2.3 The minimum recorded track width was selected to provide maximum freedom from defect-caused signal dropouts consistent with reasonable head design practices.

A2.4.2.4 Width of read tracks is not specified. It is assumed that equipment manufacturers will select an optimum read track width for their particular equipment.

A2.4.3 Track Identification and Bit Assignment

A2.4.3.1 The track numbering is logically assigned 1 through 9, starting at the reference edge of the tape.

A2.4.3.2 The bit assignments were selected to agree with previous densities with 9-track format.

A2.4.4 Parity. Odd character parity was selected to agree with previous densities with 9-track format.

A2.4.5 Block Length

A2.4.5.1 The minimum block length was selected to agree with the 800 CPI, NRZI 9-track format. There is no technical restriction in the GRC method that necessitates a minimum data length requirement.

A2.4.5.2 Each record containing less than seven data characters shall consist of a preamble, Mark 1 and End Data control subgroups, residual and CRC data groups, a Mark 2 control subgroup, and a postamble.

A2.4.5.3 The maximum block length was selected to permit processing on the smallest systems and accommodation by reasonably sized buffers.

A2.4.6 Gap Sizes. Gap sizes are specified to improve throughput. The maximum gap is specified to permit corrective action when gaps of excessive length are encountered (successive erase instructions).

A2.4.7 Tape Mark. The Tape Mark was chosen to minimize the possibility of recognizing it as a data block, and vice versa. For noninterchange applications, similar control block combinations are possible, either

across the width of tape or by segmenting the longer length of the control block to provide additional combinations.

A2.4.8 Control Subgroups. The control subgroups are not translated but are written as indicated on the tape.

A3. Additional Considerations

A3.1 Introduction. This standard is intended to define the record on the record tape for interchange purposes. Utilization of machine design criteria has been avoided to provide maximum flexibility to interchange parties in program and machine design.

A3.2 Noninterchange Applications

A3.2.1 Increased character transfer rate.

(1) Density: No restrictions on any other recording technique.

(2) Tape Speed: No restriction.

(3) Packing: Two numeric characters may be placed in one tape character, possibly by the use of track 7 for one of the bits in a numeric character.

A3.3 Information Exchange Flexibility

A3.3.1 The ASCII concept does not prohibit a variety of inherent subsets and supersets. This standard will accommodate such flexibility.

A3.3.2 Present equipment design and handling capability were given considerable weight in the choice of the particular attributes of this standard.

A3.3.3 Upon agreement between persons interchanging recorded tapes, nothing in this standard should be taken to prohibit the use of longer block lengths than those specified in the standard.

Appendix B

Measurement of Flux Reversal Spacing

B1. Procedure

B1.1 The equipment used for recording tapes (tape transport) at 6250 bits per inch should record on the magnetic tape to be used for interchange, using the format described in Table B1.

B1.2 The tape is to be written in any start-stop mode of operation compatible with system operation.

B1.3 The block is to be recorded in the GCR format.

Table B1
Worst-Case Test Patterns

Track	Test Pattern
9	1 0 0 1 1 1 0 0 1 1
8	1 1 0 0 1 1 1 0 0 1
7	1 0 0 1 1 1 0 0 1 1
6	1 1 0 0 1 1 1 0 0 1
5	1 0 1 0 1 0 1 0 1 0
4	1 1 0 0 1 1 1 0 0 1
3	1 0 0 1 1 1 0 0 1 1
2	1 1 0 0 1 1 1 0 0 1
1	0 1 0 0 1 1 0 1 1 0

NOTE: Record tape with data patterns as shown the full length of a 2400-foot reel of tape.

B2. Instrumentation

B2.1 Any method of measurement that meets the intent of Section B1 is acceptable.

B2.2 Typical instrumentation is shown in block-diagram form in Fig. B1.

B3. Reference Transitions

The reference transitions are as indicated in Fig. B2.

B4. Head

B4.1 There are no voltage output specifications. However, sufficient output must be available to minimize signal-to-noise ratio problems.

B4.2 In the frequency range of 7 kHz the magnitude characteristic must be within 1 dB from a +6-dB-per-octave line.

B5. Explanation

B5.1 The tape from the write unit is read through the instrumentation chain.

B5.2 The digital counter allows delay from the detected interblock gap (IBG) out to the transition to be measured.

B5.3 The start-stop pulses from the computing counter displayed in Fig. B1 adjacent to "limited data" show which time between transitions is being measured.

B5.4 The gate from the oscilloscope to the computer counter triggers the measurement.

B5.5 Measurement samples are made once on each block for a minimum of 100 blocks.

B5.6 Average measurements associated with 4.3.2 of the standard are made in the stable part of the preamble closest to the data where the density is 9042 frpi.

B5.7 Average data pulse width increases are converted to percentages by comparison with associated positive or negative average flux spacings as measured in B5.6.

B5.8 Downstream shift of the indicated reference transition can be measured directly from an oscilloscope display of the pulse train and compared with the predicted computed average flux location.

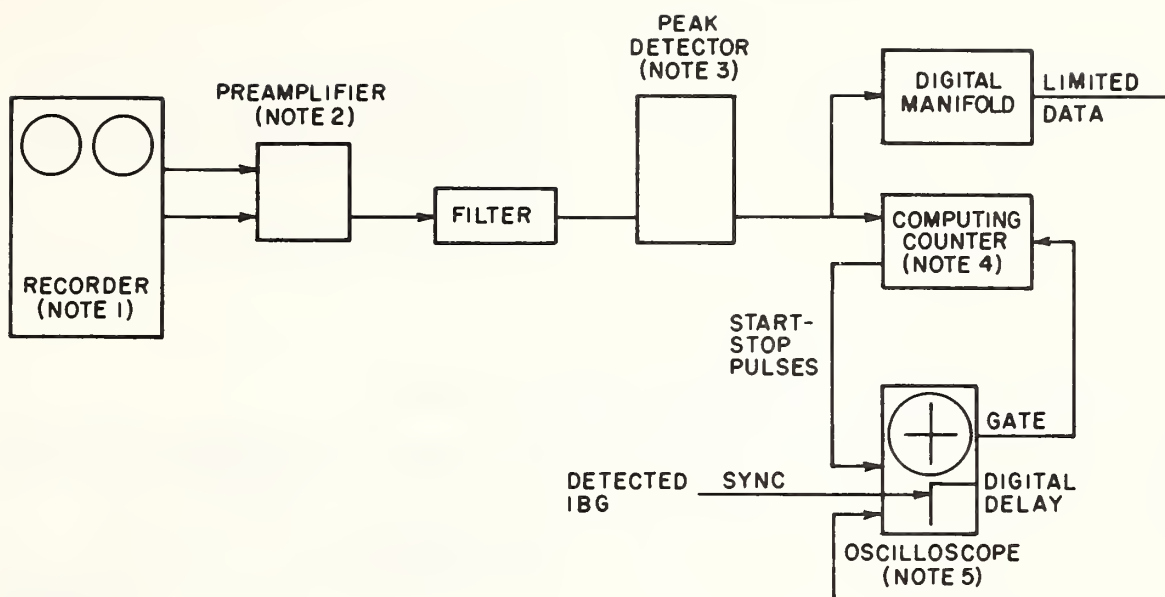

- NOTES:
- (1) Such as Bell & Howell VR 3700B (60 in/s), or the equivalent.
 - (2) Such as Tektronix 7A22, or the equivalent.
 - (3) Such as LeCroy 1124, or the equivalent.
 - (4) Such as Hewlett-Packard 5360A, or the equivalent.
 - (5) Such as Tektronix 7D11, or the equivalent.

Fig. B1
Flux Reversal Spacing Measurement Instrumentation

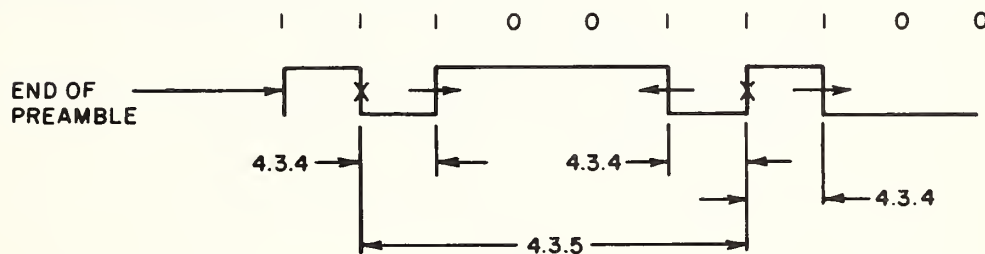

- NOTES:
- (1) Crosses denote reference transitions.
 - (2) Numbers adjacent to dimension lines refer to corresponding section numbers of the standard.
 - (3) Pulse deviations from reference transitions will occur in the direction indicated by the arrows.

Fig. B2
Reference Transitions

Appendix C

Determination of Rate of Change

C1. Definition of Rate of Change

The rate of change is given by the following relationship:

$$\text{Rate of change} = \frac{\left| \frac{t_1}{4} - \frac{t_2}{4} \right|}{\frac{t_3}{5}}$$

where t_1 , t_2 , and t_3 are the times between flux reversals, as shown in Fig. C1. Periods 1 through 5 are contiguous, and frequency variations are less than 20 kHz.

C2. Instrumentation

C2.1 Any method of measurement that meets the intent of Section C1 is acceptable.

C2.2 Phase components induced in the write process can be a significant part of the measurement. Care

must be exercised to minimize the effects of both noise and phase to the point where neither causes erroneous results in the attempt to measure the effect of velocity.

C2.3 Typical instrumentation is shown in Fig. C2.

C3. Explanation

C3.1 The tape from the write unit is read through the instrumentation chain.

C3.2 Samples are made on every other positive pulse of the digitized train.

C3.3 The storage oscilloscope vertical deflection is calibrated in percentages.

C3.4 The time between flux reversals is converted to height percentage of nominal.

C3.5 The deviation in percent between pulses is read directly and divided by 4 to test to specification.

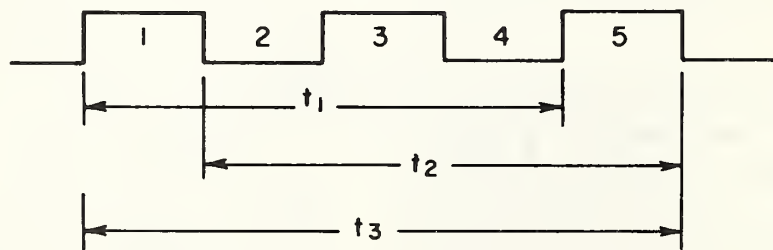
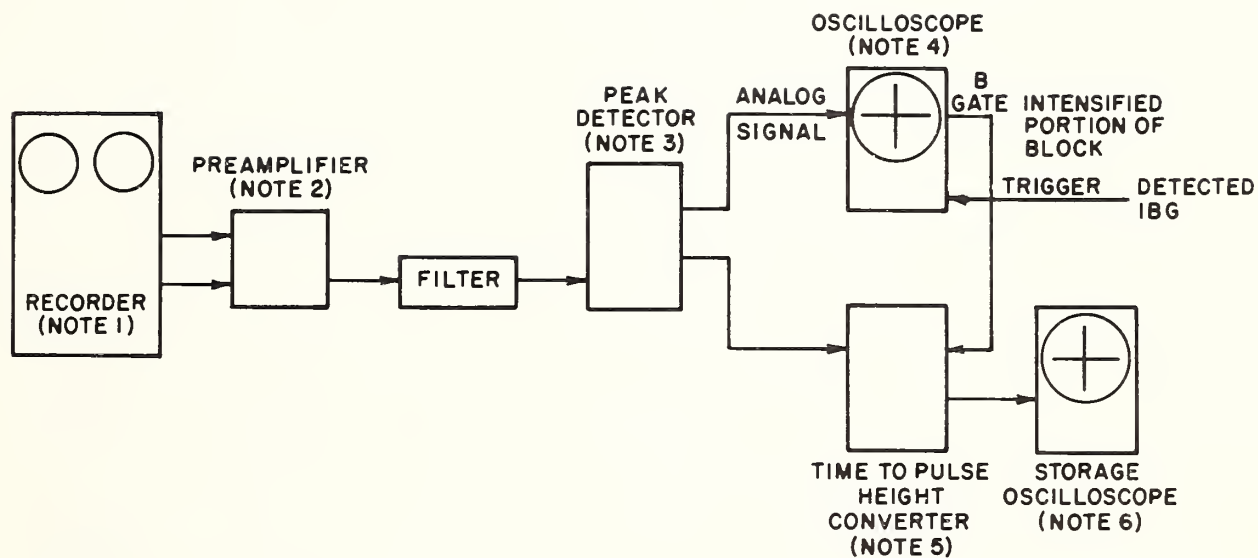

Fig. C1
Parameters for Rate-of-Change Determination



NOTES:

- (1) Such as Bell & Howell VR 3700B (60 in/s), or the equivalent.
- (2) Such as Tektronix 7A22, or the equivalent.
- (3) Such as LeCroy 1124, or the equivalent.
- (4) Such as Tektronix 475, or the equivalent.
- (5) Such as LeCroy 208, or the equivalent.
- (6) Such as Tektronix 549, or the equivalent.

Fig. C2
Instrumentation for Measuring Rate of Change

To ANSI
Sales Department

AMERICAN NATIONAL
STANDARD NO. _____

Please advise me when new editions of
are issued.

PLEASE FILL IN ANSI
Designation
Only One Number Per Card

PLEASE PRINT

Name _____

Company _____

Address _____

City _____ State _____ Zip _____

FIRST CLASS MAIL

Place
Stamp
Here

SALES DEPARTMENT

American National Standards Institute

1430 Broadway

New York, N. Y. 10018

American National Standards on Computers and Information Processing

- X3.1-1976** Synchronous Signaling Rates for Data Transmission
- X3.2-1970 (R1976)** Print Specifications for Magnetic Ink Character Recognition
- X3.3-1970 (R1976)** Bank Check Specifications for Magnetic Ink Character Recognition
- X3.4-1977** Code for Information Interchange
- X3.5-1970** Flowchart Symbols and Their Usage in Information Processing
- X3.6-1965 (R1973)** Perforated Tape Code for Information Interchange
- X3.9-1966** FORTRAN
- X3.10-1966** Basic FORTRAN
- X3.11-1969** Specification for General Purpose Paper Cards for Information Processing
- X3.12-1970** Vocabulary for Information Processing
- X3.14-1973** Recorded Magnetic Tape for Information Interchange (200 CPI, NRZI)
- X3.15-1976** Bit Sequencing of the American National Standard Code for Information Interchange in Serial-by-Bit Data Transmission
- X3.16-1976** Character Structure and Character Parity Sense for Serial-by-Bit Data Communication in the American National Standard Code for Information Interchange
- X3.17-1977** Character Set and Print Quality for Optical Character Recognition (OCR-A)
- X3.18-1974** One-Inch Perforated Paper Tape for Information Interchange
- X3.19-1974** Eleven-Sixteenths-Inch Perforated Paper Tape for Information Interchange
- X3.20-1967 (R1974)** Take-Up Reels for One-Inch Perforated Tape for Information Interchange
- X3.21-1967** Rectangular Holes in Twelve-Row Punched Cards
- X3.22-1973** Recorded Magnetic Tape for Information Interchange (800 CPI, NRZI)
- X3.23-1974** Programming Language COBOL
- X3.24-1968** Signal Quality at Interface between Data Processing Terminal Equipment and Synchronous Data Communication Equipment for Serial Data Transmission
- X3.25-1976** Character Structure and Character Parity Sense for Parallel-by-Bit Communication in the American National Standard Code for Information Interchange
- X3.26-1970** Hollerith Punched Card Code
- X3.27-1977** Magnetic Tape Labels and File Structure for Information Interchange
- X3.28-1976** Procedures for the Use of the Communication Control Characters of American National Standard Code for Information Interchange in Specified Data Communication Links
- X3.29-1971** Specifications for Properties of Unpunched Oiled Paper Perforator Tape
- X3.30-1971** Representation for Calendar Date and Ordinal Date for Information Interchange
- X3.31-1973** Structure for the Identification of the Counties of the United States for Information Interchange
- X3.32-1973** Graphic Representation of the Control Characters of American National Standard Code for Information Interchange
- X3.34-1972** Interchange Rolls of Perforated Tape for Information Interchange
- X3.36-1975** Synchronous High-Speed Data Signaling Rates between Data Terminal Equipment and Data Communication Equipment
- X3.37-1977** Programming Language APT
- X3.38-1972** Identification of States of the United States (Including the District of Columbia) for Information Interchange
- X3.39-1973** Recorded Magnetic Tape for Information Interchange (1600 CPI, PE)
- X3.40-1976** Unrecorded Magnetic Tape for Information Interchange (9-Track 200 and 800 CPI, NRZI, and 1600 CPI, PE)
- X3.41-1974** Code Extension Techniques for Use with the 7-Bit Coded Character Set of American National Standard Code for Information Interchange
- X3.42-1975** Representation of Numeric Values in Character Strings for Information Interchange
- X3.43-1977** Representations of Local Time of the Day for Information Interchange
- X3.44-1974** Determination of the Performance of Data Communication Systems
- X3.45-1974** Character Set for Handprinting
- X3.46-1974** Unrecorded Magnetic Six-Disk Pack (General, Physical, and Magnetic Characteristics)
- X3.48-1977** Magnetic Tape Cassettes for Information Interchange (3.810-mm [0.150-in] Tape at 32 bpm [800 bpi], PE)
- X3.49-1975** Character Set for Optical Character Recognition (OCR-B)
- X3.50-1976** Representations for U.S. Customary, SI, and Other Units to Be Used in Systems with Limited Character Sets
- X3.51-1975** Representations of Universal Time, Local Time Differentials, and United States Time Zone References for Information Interchange
- X3.52-1976** Unrecorded Single-Disk Cartridge (Front Loading, 2200 BPI), General, Physical, and Magnetic Requirements
- X3.53-1976** Programming Language PL/I
- X3.54-1976** Recorded Magnetic Tape for Information Interchange (6250 CPI, Group Coded Recording)
- X3.55-1977** Unrecorded Magnetic Tape Cartridge for Information Interchange, 0.250 Inch (6.30 mm), 1600 bpi (63 bpm), Phase Encoded
- X3.56-1977** Recorded Magnetic Tape Cartridge for Information Interchange 4 Track, 0.250 Inch (6.30 mm), 1600 bpi (63 bpm), Phase Encoded
- X3.57-1977** Structure for Formatting Message Headings for Information Interchange Using the American National Standard Code for Information Interchange for Data Communication System Control
- X3.58-1977** Unrecorded Eleven-Disk Pack General, Physical, and Magnetic Requirements

For a free and complete list of all American National Standards, write:

American National Standards Institute, Inc
1430 Broadway
New York, N.Y. 10018