

# A Unique Institution

The National Bureau  
of Standards  
1950–1969

A Unique Institution

The National Bureau of Standards 1950–1969

Elio Passaglia

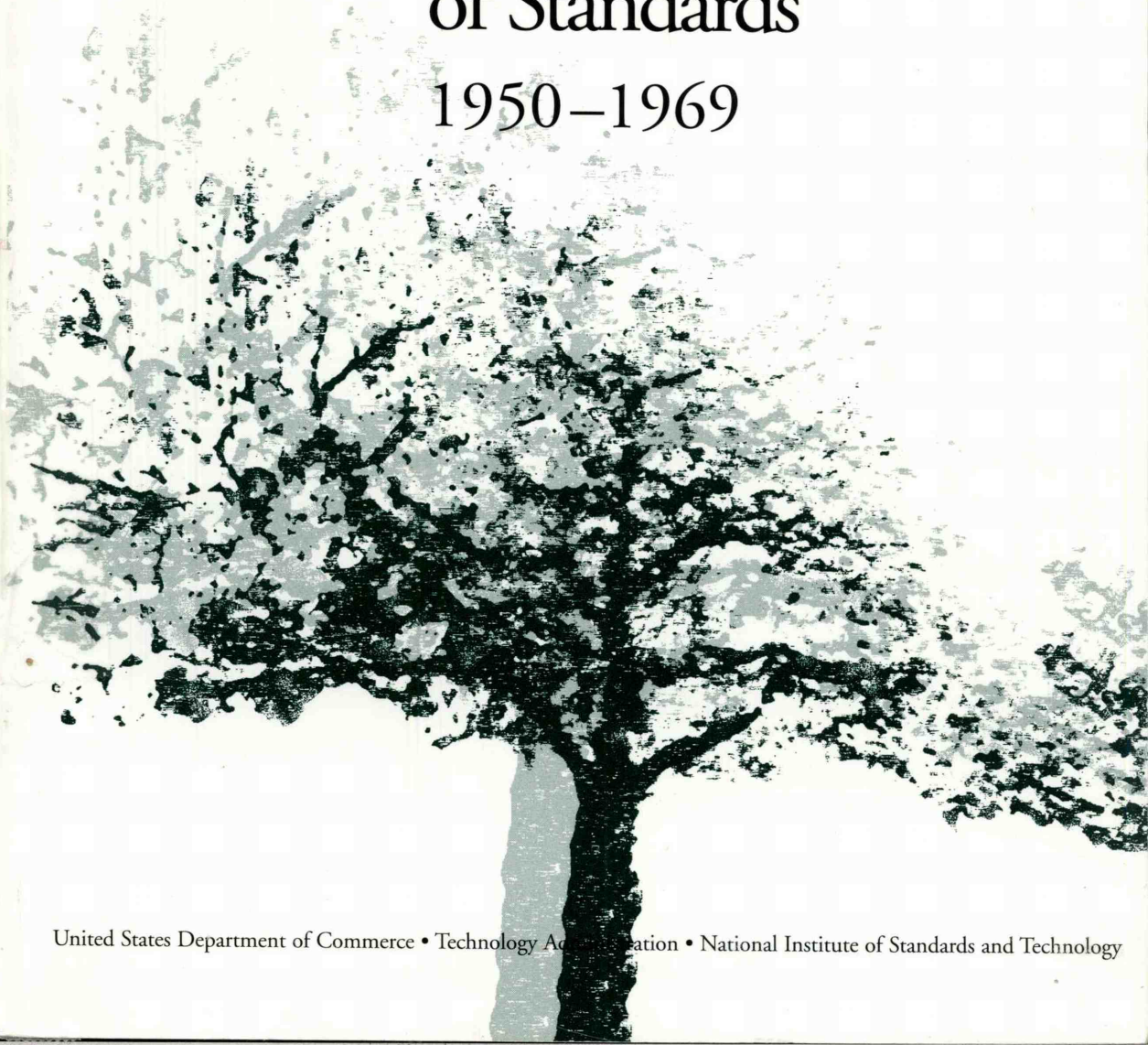

NIST

SP 925

United States Department of Commerce • Technology Administration • National Institute of Standards and Technology

# A Unique Institution

The National Bureau  
of Standards  
1950–1969

Elio Passaglia

*with Karma A. Beal*



**U.S. Department of Commerce**

William M. Daley, Secretary

**Technology Administration**

Gary R. Bachula, Acting Under Secretary for Technology

**National Institute of Standards and Technology**

Raymond G. Kammer, Director

Cover design by Adele Passaglia Robey.

End papers for hard-bound version:

Front end paper—National Prototype Meter No. 27.

Back end paper—orange-red spectral line of krypton 86,  
which replaced the meter bar as the International Standard  
of Length in 1960.

---

## FOREWORD

---

*The New York Times*, in a front-page article in its September 17, 1997, issue declared that "... Moore's Law, a long-standing axiom of the computer age, is no longer true"; concluding that "Powerful innovation in chip design could speed obsolescence of today's computers." That announcement heralded a new development which in effect altered the basic physics of computer chip design and which destroyed the basic premise of forecasting the certainty of the rate at which computer chips became obsolete. In 1965, as a research engineer at Fairchild Semiconductor, I made the observation that as the result of advancements in electrical engineering, materials science, and the evolution of computer chip design, the power of microchips would double every 18 months with proportionate cost decreases. That observation became known as Moore's Law; the fact that it has persevered for this time does not reflect on the challenges facing our research institutions, as well as the unsung contributions they have made to the advancement of science and society.

The National Institute of Standards and Technology will be celebrating in March, 2001 the centennial of its founding as the National Bureau of Standards. Through its leadership in accurate measurement and its ability to solve a myriad of technical problems, NBS/NIST has contributed to the evolution of a number of technological developments impacting the lives of all around the world. These have included such contributions as the automobile, the airplane, radio and television, computers and their functionality, and space flight.

The first fifty years of the NBS are covered by Rexmond C. Cochrane's *Measures for Progress*, which was published in 1966 by the U.S. Department of Commerce. It is a book well worth reading, for it captures the masterful achievements through which NBS expertise permeated the technical advancements of our country during a period of revolutionary change in science and technology, in part driven by two world wars. The end of this period also coincided with the beginning of a new age, the Information Age, heralded by the invention of the transistor in 1947.

The transistor is the basic unit of information storage on a computer chip. Today we can squeeze 32 million transistors on one microchip. Newly announced versions will have the capability of storing 64 million bits of data. The development of the transistor moved the computer from the special-purpose, large, climate-controlled rooms to the desktop. This computer revolution is best characterized not solely by the growth in computing power of the machine, but by the enhancement of the reach of the human spirit. Nearly every school child in America and, increasingly so, people in most of the other developed countries of the world have finger-tip electronic access to information compiled by libraries, governmental agencies, and private institutions and individuals. We drive automobiles that incorporate electronic circuits and computers for ignition control, and in some cases for braking and security.

I understand that NIST has an average of two computers for each staff member. Many of these are used for conducting experimental research, theoretical modeling and simulation, as well as for accessing and manipulating the knowledge bases that are

needed to develop new knowledge. NIST has remained in the forefront of this new revolution, both through imaginative scientific work and by helping to create standards for the use and protection of this information exchange. As has been the case throughout its existence, NIST is home to chemists, physicists, metallurgists, mathematicians, engineers, and experts in many other technical disciplines. Some see themselves as individuals focusing on the arcane details of their chosen profession, while others engage in extensive interdisciplinary activities that cut across a variety of professions. They are driven to understand, to measure, and to communicate. They provide objective, precise information to be used by others throughout the fabric of America's workplace and home; assembled into teams, they help to make whole industries better competitors in the world marketplace. They operate within a world-renowned culture of scientific integrity, an integrity which has withstood the test of time and politics.

This volume, *A Unique Institution*, records the challenges that have faced NBS/NIST and the opportunities of which it availed itself to maintain a high level of excellence in discharging its mission as a national resource. It is a distinct pleasure and a great honor to commend this history to readers everywhere.

Gordon E. Moore  
*Chairman Emeritus*  
*Board of INTEL Corporation*

---

## PREFACE

---

Like its predecessor, *Measures for Progress*, this volume is intended for a variety of audiences. They range from the technical specialist with an active interest in the work of this institution to those among the more general public with an appreciation for how the threads of science, technology and society have intertwined during a critical period in our nation's history.

It aspires to paint a picture, admittedly incomplete but clearly indicative, of an institution rich in tradition, with a wonderful reputation for both "academic" excellence and industrial relevance. The time span covered by this volume, 1950-1969, was a period of tremendous change for this nation. Those changes are reflected in the variety of assignments made to the National Bureau of Standards and the issues that faced NBS during these two decades.

The success of the "Bureau"—as it is still fondly called by many of the agency's staff, alumni and friends—presaged and laid the foundation for the expanded role given to the agency when Congress changed the institution's name and transformed it into the National Institute of Standards and Technology in 1988. In large part, it was NBS' ability to creatively tackle new assignments while maintaining both its integrity and its industrial relevance which led Congress to establish NIST.

A considerable amount of space—an entire chapter, in fact—is devoted to the so-called AD-X2 battery additive case. That is fitting, because the way in which NBS officials and staff handled themselves in the face of extreme outside pressure reflects the nature of the institution. This chapter speaks volumes about the importance of technical integrity for this agency. More than 40 years later, the AD-X2 example remains as a constant reminder, as a guidepost, for the institution's staff whenever they are faced with difficult situations. Maintaining our technical integrity was foremost when it came to the AD-X2, and it remains the defining characteristic and core value of NIST today.

Measurements and standards always have been at the heart of this institution's mission, its premier *raison d'être*, and this history spotlights key technical accomplishments that served to advance our technical infrastructure. It is appropriate that this summary features standards developments and issues, as well as the establishment of the National Standard Reference Data System.

During the period covered by this volume, NBS expanded to its Boulder, Colorado, site and the agency's major laboratories and headquarters were relocated from their long-time home in downtown Washington, D.C. to the expanded, more capable and then-rural facilities in Gaithersburg, Maryland. Both moves are chronicled in this history, and they serve as an excellent frame of reference as we are beginning to make urgently needed major laboratory upgrades more than 30 years later. The similarities in both technical need and management challenges are instructive.

As the role of technology in the economy and society continues to take on even greater importance, the mission and work of this agency is even more crucial today than it was earlier in the century. If the old adage is correct, and past is prologue, this volume should be required reading for the many individuals who are steering or observing this institution as it reaches its centennial and as we move into the next millennium. For it is, indeed, A Unique Institution.

Raymond G. Kammer  
*Director*  
*National Institute of Standards and Technology*

This page intentionally left blank

---

## ACKNOWLEDGMENTS

---

Elio Passaglia wrote this book as the story of an institution that steadfastly holds to its principles of integrity in all of its endeavors. He introduces each chapter with an overview of what was happening in the United States—and the world—to set the stage for the policies and programs of the National Bureau of Standards and for the changes that would be made. In the last year of his life, he finished the manuscript and turned it over to others to bring to publication. Working with Elio, I learned more about the Bureau than I thought possible and I feel privileged to have been a participant in this process. It is my hope that I did not inadvertently introduce errors into the text.

As with the previous history, *Measures for Progress*, not all the programs and projects could be covered, for the multitude of records generated during this nineteen-year period was staggering. Elio selected those he considered representative of the work of NBS. The annual reports provided a rich source of material as did the many conversations with the present and past scientists and managers that Elio consulted. Footnotes abound throughout the text to provide the necessary documentation, and to serve as guides to sources providing fuller explanations of the projects and programs covered, or even to opposing viewpoints.

It should be noted that, for this history, Elio relied heavily on the language and terminology of the written materials that he was able to research in order to prepare this volume. In particular, the cited results are reported in the units current at the time when the research was conducted and reported, predating the *Guide for the Use of the International System of Units (SI)* by Barry N. Taylor, which states that “the SI shall be used in all NIST publications.” Accordingly, units, uncertainties, and symbols do not always accord with modern practice and current NIST requirements.

The writing of this history was aided and encouraged by many. Patricia W. Berger, David E. Edgerly, and Mary-Deirdre Coraggio guided the project from its inception to publication. The NIST community provided the necessary records and other available information, spent time explaining the finer points on what was given, and then critiqued the drafts. Past and present NBS/NIST staff who were particularly helpful include Karl E. Bell, John A. Bennett, Stanley Block, Lewis M. Branscomb, B. Stephen Carpenter, Russell C. Casella, Randall S. Caswell, E. Carroll Creitz, Mary E. DeWeese, Kenneth M. Evenson, James E. Faller, Everett G. Fuller, Thomas A. Gary, Jon Geist, Walter J. Hamer, Raymond W. Hayward, Joseph Hilsenrath, Robert D. Huntoon, James L. Jespersen, Freddy A. Khoury, H. William Koch, Chris E. Kuyatt, Stephen R. Leone (JILA/University of Colorado), Alvin C. Lewis, David R. Lide, John W. Lyons, Robert P. Madden, William C. Martin, Arthur O. McCoubrey, Harry I. McHenry, John D. McKinley, Raymond D. Mountain, Gasper J. Piermarini, Robert C. Raybold, Joan R. Rosenblatt, J. Michael Rowe, Alvin H. Sher, Jack E. Snell, Wilbert F. Snyder, Joan M. Stanley, Bruce W. Steiner, Robert D. Stiehler, Robert L. Stern, Donald B. Sullivan, Lauriston S. Taylor, Robb M. Thomson, Robert S. Walleigh, Sheldon M. Wiederhorn, Richard N. Wright, and Simone L. Yaniv. They answered a host of questions, read many pages of text, and offered suggestions often with only a moment's notice. Suzanne C. Evans, Frederick J. Gera, Janet B. Miller, and



Gregory C. Tassej checked budget numbers, tables, and graphs, and for their assistance I am truly grateful. Walter Leight, nitpicker extraordinaire, read the entire manuscript and offered his comments. To the many others that Elio consulted and whose names were not found in the project files, you may be unknown but your contributions to this project were just as important as the others.

Joseph H. Condon was most helpful in reviewing and offering suggestions on the section about his father, Edward U. Condon. Shirley Cochrane, Elio's non-scientific writing colleague outside of the Bureau, provided stylistic review.

A faithful History Resource Committee was part of the backbone of the writing process. I am deeply indebted to all of the members: Ernest Ambler, Elmer H. Eisenhower, Daniel Gross, John D. Hoffman, Emanuel Horowitz, Ralph P. Hudson, Robert A. Kamper, Lawrence M. Kushner, Hans Oser, H. Steffen Peiser, Jacob Rabinow, Shirley M. Radack, Robert Schaffer, James F. Schooley, Johanna Levelt Sengers, John A. Simpson, W. Reeves Tilley, and John B. Wachtman, Jr. They read and reread drafts, and also met regularly to discuss what was written or omitted. Unfortunately, William C. Cullen, Churchill Eisenhart, Karl G. Kessler, and Howard E. Sorrows, original members of the committee, did not live to see the publication of the book they helped to bring into existence. Their presence is missed by all. The committee's job is not yet finished as it continues as a group through the writing of the next volume of history.

The Office of Information Services provided the glue to hold the editorial process together. Paul Vassallo gave his managerial support at critical junctures to keep the project moving. Diane Cunningham, Susan Makar, and Marietta Nelson ferreted out names, titles, dates, and elusive tidbits of information needed to complete citations and reveal previously undetected errors. Gail Hixenbaugh, Donald Harris, and Julian Ives edited the manuscript at its various stages. Very special thanks go to Lisa Greenhouse and Ilse Putman. Lisa selected the photographs, edited early drafts of chapters four and five, and searched for information to resolve a great many unanswered questions that always seemed to pop out of nowhere. Ilse produced the typeset copy, always with patience for the inevitable changes made in the manuscript. The pursuit of excellence as reflected by all those who participated from the initial conception of the idea to the published text is shown in the final product.

The cover was given as a labor of love by Elio's daughter, Adele Passaglia Robey. She immediately accepted the invitation to design the cover around the NIST Newton apple tree. Adele was involved with "the book" from its inception. She followed her father's writing, read parts of it, and as an "educated layman" offered her thoughts. The tree on the cover is a symbol of what NBS/NIST is all about: the living traditions and frontiers of science. This history is a reflection of that tradition and those frontiers.

KARMA A. BEAL

*Gaithersburg, MD  
July 1999*

# CONTENTS

	Page
FOREWORD .....	iii
PREFACE.....	v
ACKNOWLEDGMENTS .....	vii
 <b>CHAPTER ONE:</b>	
<b>THE NATIONAL BUREAU OF STANDARDS AT MID-CENTURY.....</b>	<b>1</b>
A NERVOUS NATION.....	1
THE STATE OF SCIENCE.....	6
A UNIQUE INSTITUTION .....	14
THE NATURE AND CHARACTER OF THE BUREAU .....	19
THE TECHNICAL WORK.....	34
Length and Light: Natural Standards v. Artifacts.....	37
Applied Mathematics and Computers .....	40
The Isotope Effect in Superconductivity .....	44
The Charters of Freedom .....	47
Standards and Fundamental Constants .....	54
The Bureau and X Rays: High Energies Come to the Bureau .....	56
LIFE AT THE BUREAU .....	62
 <b>CHAPTER TWO:</b>	
<b>TESTING CAN BE TROUBLESOME .....</b>	<b>71</b>
POLICIES ON COMMODITY TESTING AND PUBLICATIONS.....	72
THE AQUELLA INCIDENT.....	74
THE BATTERY ADDITIVE INCIDENT.....	79
BATTERIES AND BATTERY ADDITIVES.....	80
A SHORT TECHNICAL NOTE .....	84
THE INCIDENT BEGINS .....	87
THE INCIDENT DEVELOPS .....	89
THE NATIONAL BETTER BUSINESS BUREAU .....	92
THE MILITARY TESTS.....	93
THE BUREAU TESTS AD-X2 AND THE PACE QUICKENS .....	94
THE BUREAU GOES PUBLIC ON AD-X2.....	95
RITCHIE GOES POLITICAL .....	101
THE POST OFFICE ENTERS THE FRAY, AND THE FEDERAL TRADE COMMISSION TAKES ANOTHER LOOK .....	102
THE SENATE SELECT COMMITTEE ON SMALL BUSINESS GETS INVOLVED.....	104

	Page
<b>CHAPTER TWO: (Continued)</b>	
FINALLY A PUBLIC TEST . . . . .	105
MIT CONDUCTS TESTS WITH SEEMINGLY STARTLING RESULTS . . . . .	107
THE POST OFFICE DEPARTMENT TAKES ACTION . . . . .	110
THE BEGINNING OF THE RESOLUTION . . . . .	111
ASTIN IS FIRED AND WEEKS LEARNS THE WAYS OF WASHINGTON . . . . .	114
THE VISITING COMMITTEE . . . . .	119
THE SENATE HEARINGS . . . . .	121
THE INCIDENT WINDS DOWN . . . . .	127
THE POST OFFICE DEPARTMENT AND THE FEDERAL TRADE COMMISSION . . . . .	128
THE BUREAU . . . . .	129
THE COMMITTEES REPORT . . . . .	130
CONCLUSIONS . . . . .	133

**CHAPTER THREE:**

<b>DIVESTITURE AND REAFFIRMATION, 1950-1957 . . . . .</b>	<b>137</b>
A PLACID NATION . . . . .	137
SCIENCE GROWS EXPLOSIVELY . . . . .	143
DIVESTITURE AND REAFFIRMATION . . . . .	148
A NEW ORGANIC ACT . . . . .	149
LOYALTY, SECURITY, AND THE RESIGNATION OF A DIRECTOR . . . . .	154
ALLEN VARLEY ASTIN . . . . .	171
FULLFILLING A REPORT . . . . .	173
THE ACQUISITION OF THE BOULDER SITE, AND A NEW PROGRAM IN CRYOGENIC ENGINEERING . . . . .	182
POSTDOCS COME TO THE BUREAU . . . . .	188
AN INSTRUMENTATION PROGRAM . . . . .	191
THE TECHNICAL WORK . . . . .	193
ELECTRICITY; OPTICS AND METROLOGY . . . . .	193
Project Tinkertoy . . . . .	200
HEAT AND POWER . . . . .	203
The Parity Experiment . . . . .	207
ATOMIC AND RADIATION PHYSICS . . . . .	213
CHEMISTRY . . . . .	218
MECHANICS . . . . .	226

	Page
<b>CHAPTER THREE: (Continued)</b>	
MATERIALS RESEARCH .....	231
Organic and Fibrous Materials .....	232
Metallurgy .....	238
Ship Failures .....	240
Mineral Products .....	246
BUILDING TECHNOLOGY .....	253
APPLIED MATHEMATICS AND COMPUTERS .....	261
CENTRAL RADIO PROPAGATION LABORATORY .....	269
The Speed of Light .....	278
TESTING .....	282
SUMMARY .....	285
 <b>CHAPTER FOUR:</b>	
<b>REORIENTATION AND RECONSTITUTION, 1958-1964 .....</b>	<b>287</b>
THE BEGINNING OF A TIME OF TURMOIL .....	287
Foreign Affairs .....	288
National Affairs .....	291
THE GLORY DAYS .....	294
THE BUREAU .....	297
Budget Matters .....	298
An Evaluation and a Status Report .....	304
An Organization Changes .....	312
JILA, The Joint Institute for Laboratory Astrophysics .....	322
The National Standard Reference Data System .....	329
Civilian Industrial Technology—The Bureau Gets a Small, Short Program .....	333
A Bold Proposal Leads to a Major Reorganization .....	338
THE TECHNICAL WORK .....	345
STANDARDS MATTERS .....	345
Length .....	345
Temperatures High and Low .....	353
High Pressures .....	355
Large Forces .....	362
Time and Frequency .....	367
<i>Frequency Standards</i> .....	368
<i>The Definition of the Second</i> .....	372
<i>Frequency and Time Dissemination</i> .....	374

	Page
<b>CHAPTER FOUR: (Continued)</b>	
Calibrations.....	377
Standard Samples Become Standard Reference Materials .....	379
The End of Product Testing.....	380
Commodity Standards and a Reversal of Position .....	381
Weights and Measures .....	382
The International Yard and Pound; SI.....	385
A TOUR OF THE DIVISIONS .....	387
Optics and Metrology.....	387
Mechanics.....	389
The Electricity Division Stimulates Polymer Science .....	390
Radio Standards .....	395
Heat.....	398
<i>A Program on Free Radicals</i> .....	399
Atomic and Molecular Physics .....	402
<i>A New Light Source</i> .....	405
<i>Molecular Spectroscopy</i> .....	410
Radiation Physics.....	411
<i>Two New Radiation Sources</i> .....	413
Chemistry .....	419
Materials.....	421
Applied Mathematics .....	430
Data Processing .....	433
Instrumentation.....	436
Central Radio Propagation Laboratory .....	438
<i>The International Geophysical Year</i> .....	439
Cryogenics .....	445
Building Research.....	449
 <b>CHAPTER FIVE:</b>	
<b>TECHNOLOGICAL TRIUMPH: SOCIAL TURMOIL, 1964-1969.....</b>	<b>453</b>
THE VIETNAM AGONY .....	453
A SPATE OF LEGISLATION.....	456
TECHNOLOGICAL TRIUMPH AND DRAMA .....	460
THE RISE OF RELEVANCE .....	460

## CHAPTER FIVE: (Continued)

TOWARD A NEW LEADERSHIP . . . . .	465
BUDGET, PERSONNEL AND MANAGEMENT MATTERS . . . . .	466
THE PLANNING-PROGRAMMING-BUDGETING SYSTEM . . . . .	472
THE GAITHERSBURG RELOCATION. . . . .	474
ENVIRONMENTAL SCIENCE SERVICES ADMINISTRATION. . . . .	492
A NUMBER OF NEW RESPONSIBILITIES . . . . .	493
Automobile Safety . . . . .	494
Automatic Data Processing (ADP) . . . . .	500
Fire Research and Safety . . . . .	504
SYSTEMS ANALYSIS AND THE TECHNICAL ANALYSIS DIVISION . . . . .	507
THE NATIONAL MEASUREMENT SYSTEM. . . . .	510
THE CLEARINGHOUSE FOR FEDERAL SCIENTIFIC AND TECHNICAL INFORMATION. . . . .	513
INVENTION AND INNOVATION . . . . .	515
A DIRECTOR RETIRES . . . . .	518
STANDARDS MATTERS . . . . .	521
LASERS AND NEW VISTAS IN METROLOGY . . . . .	522
Time Dissemination . . . . .	529
Mass and Measurement Assurance Programs . . . . .	533
The Josephson Effect and Maintenance of the Volt. . . . .	537
Temperature . . . . .	541
Radio Standards . . . . .	542
Toward a New Era in Radiometry. . . . .	544
Standard Reference Materials (SRMs) . . . . .	550
Standard Reference Data . . . . .	553
Weights and Measures for the States . . . . .	555
Federal Information Processing Standards . . . . .	558
THE GENERAL RESEARCH . . . . .	560
Superconducting Semiconductors . . . . .	560
Electron Scattering From Nuclei . . . . .	563
Making the Draft Lottery Impartial. . . . .	565
Research at the Reactor . . . . .	567
Critical Phenomena. . . . .	569
Fracture Mechanics Comes to the Bureau. . . . .	573
The Investigation of the Point Pleasant Bridge Collapse . . . . .	576

	<b>Page</b>
<b>CHAPTER FIVE: (Continued)</b>	
Atomic Weights and Isotopic Abundances .....	580
A Program on Crystal Growth.....	582
Silicon Resistivity.....	586
Evaluation Nuclear Radiation Detectors .....	588
Building Research and the Performance Concept.....	590
Disaster Investigation.....	592
Experiments in Fire and Smoke.....	595
SUMMARY .....	598
 <b>APPENDICES</b>	
A. Tables .....	601
B. Acronyms Dictionary .....	603
C. Legislation Relating to the Organization, Functions, and Activities of the National Bureau of Standards .....	607
D. The National Bureau of Standards in the Federal Administration..	659
E. Appropriations and Expenditures Charts .....	661
F. Members of the Visiting Committee of the Secretary of Commerce to NBS and NIST .....	665
G. NBS Authorized Personnel Chart .....	669
H. NBS/NIST Publications .....	671
I. Organizational Levels of the National Bureau of Standards .....	689
J. Site Information and Maps: Gaithersburg and Boulder.....	777
 <b>BIBLIOGRAPHIC NOTE AND REFERENCES.....</b>	 783
 <b>INDEX.....</b>	 787

---

## CHAPTER ONE

---

### THE NATIONAL BUREAU OF STANDARDS AT MID-CENTURY

#### A NERVOUS NATION

In the year that marked the midpoint of the 20th century, the National Bureau of Standards (NBS) looked forward to its fiftieth anniversary. Formed in 1901 to maintain custody of the national standards of measurement and to develop new ones as needed by the burgeoning industry of the country, the Bureau had done this and more. It also had become a national corporate laboratory in the physical sciences, concerned with the problems of the Nation that had a technical base, from the propagation of radio waves to the underground corrosion of gas pipelines, from the development of more accurate methods of measuring length to calibrating master clinical thermometers, from providing extremely accurate time signals for the whole Nation and its territories to developing more rapid methods of analyzing the composition of steel, and many more, tedious in recitation but rich in accomplishment. The Bureau had served its Nation well in two world wars and its greatest depression. And now, in its forty-ninth year, the Nation that it served was not well; it was a decidedly nervous Nation.

Somewhat over four years earlier, the United States and its allies had won the largest war in history, although the feeling of the Nation had not been one of victory but of having completed an odious and bloody chore. And things—good and bad—had not turned out as expected. The dire depression that had been forecast by analogy with the period following the ending of the first world war had not materialized. The returning servicemen and servicewomen, and the home front workers flush with money saved during the war-year shortages, simply would not let a depression happen. Their demands, pent up for four stringent years, were too clamorous and pressing to permit a depression. Shortages—of housing, autos, appliances, meat—had occurred, and with them severe inflation despite price controls that were a relic of the war years, and which gradually were lifted. Strikes—some serious—had occurred when wage controls had not permitted wages to follow prices upward, but they had been settled, although not without some confrontation. But there was demanding work to be done. Families had to be started, educations completed, and the work of building an American civilization had to be continued. It was time to turn away from what was happening in foreign lands and concentrate on America, which, after all, was the main business of Americans.

And the war had raised aspirations among servicemen and servicewomen, and those on the home front. Throughout the New Deal and war years, minorities—Jews, African Americans, children of first generation immigrants of Southern and Eastern European lineage—had begun to taste the sweet fruits of social equality. They, and the rest of the population on the lower levels of the economic and social order, would not go back to the old days. As quoted by Goldman:





Paul L. Howard and Charles L. Faust of the Electrochemical Society presented a certificate of congratulations to Edward U. Condon on the Bureau's fiftieth anniversary in 1951.

"Times have changed," Maurice O'Connell, of the CIO, notified a Los Angeles Chamber of Commerce meeting shortly after the Japanese surrender. "People have become accustomed to new conditions, new wage scales, new ways of being treated. . . . Rosie the Riveter . . . isn't going back to emptying slop jars."<sup>1</sup>

The Government stood ready to help with these aspirations. The GI bill of rights,<sup>2</sup> which had become law in 1944, began to weave its economic and sociological magic. Young entrepreneurs could obtain Government guarantees for loans to start new businesses, home loans at what now seem absurdly low rates of interest were guaranteed for veterans by the Federal Government and, most importantly, the Government stood ready to pay for their education. Millions of ex-servicemen from working-class families, who previously could not realistically dream beyond a blue-collar job, could now aspire to a BA, an MA, or even a doctorate degree. And millions of them took advantage of this with alacrity, swelling college enrollments to a then all-time high of 2 million in 1946.

<sup>1</sup> Eric F. Goldman, *The Crucial Decade—and After: America, 1945-1960* (New York: Vintage Books, 1960) : 13.

<sup>2</sup> *Servicemen's Readjustment Act of 1944, U.S. Statutes at Large*, 58 (1944): 284.

By 1950, times were good. New cars and household appliances, while not abundant, were more generally available, and the GI-bill homes were rapidly being filled with them. There was even a new toy, a new entertainment medium called television. While only 5000 homes had TV sets in 1945, their numbers rose rapidly. By 1948 there were 1 million, and 10 million by 1952. The Nation could not get enough, and new manufacturing and entertainment industries were born. Now news events, sports, variety shows, westerns, movies, and any other feature a producer could dream up to attract an audience were brought into the American living room. American society—and American politics—would never be the same again.

Yet despite these relatively good times, and the abundant feeling that they would get better, the Nation was nervous. It found itself in an unusual and unaccustomed position: it was the most powerful nation on earth and was—indeed had to be—deeply involved in foreign affairs. No longer could the national psyche be turned inward, concerned solely with improving the state of American civilization. In all discussions, foreign relations intruded, and foreign relations were not good. International communism had to be dealt with, and hanging over everything was the unbottled genie of the atomic bomb, demanding international attention. Isolationism was gone forever.

During the war there had been general support for the alliance with the Soviet Union among both liberals and conservatives, although the latter were always nervous about it, and concerned about what would happen after the war. Yet the Yalta agreement in February 1945 seemed to predict Allied unity, and promised self-determination for the nations of Eastern Europe. It was greeted by “almost unanimous praise.”<sup>3</sup> But soon, headlines revealing a secret Yalta agreement “deemed favorable to the Soviet” increased restiveness among conservatives, and it soon became clear that the principal aim of the Soviet Union was the extension of her hegemony to all the nations of Eastern Europe. Goldman wrote: “The Russians made moves in flagrant violation of the Yalta provisions for free elections in the liberated countries of Eastern Europe,” and treated the formation of the United Nations with disdain.<sup>4</sup> In his inimitable way, Britain’s Winston Churchill, no longer speaking as the Prime Minister after the defeat of his party by Labor shortly before the surrender of Japan, added a new phrase to the English lexicon when, speaking at tiny Westminster College in Fulton, Missouri, he announced, “From Stettin in the Baltic to Trieste in the Adriatic an iron curtain has descended across the continent.”<sup>5</sup> The outlines of what was later to be named the “Cold War” by Bernard Baruch were laid out.

And the problems of communism were not to be confined to the foreign theater. Canadian spy trials indicated that a systematic Soviet espionage effort, especially on atomic and military matters was, and had been for several years, in existence. In the United States, “American Communist leaders began deserting the Party. . . . The most publicized deserter, Louis Budenz, ex-editor of the *Daily Worker*, quit with a flat statement that Communist parties anywhere were . . . conspiracies which gave their loyalty

---

<sup>3</sup> Goldman, *The Crucial Decade—and After*: 10.

<sup>4</sup> *Ibid.*, 11.

<sup>5</sup> *Ibid.*, 37.

first and last to the Soviet Union.”<sup>6</sup> Communism, in the public mind, had become not only an international menace, but an internal one as well.

The Nation had made its own moves, defensive and offensive, in response to Soviet actions. When, in a blatant attempt to drive the Western Allies from Berlin, the Soviet Union had imposed a blockade on that divided city, the Allies, in a mood of controlled fury, had carried out an airlift of supplies for the eleven months the blockade lasted and then for an additional four months. And when Communist guerrillas were in danger of overthrowing the non-Communist (though hardly democratic) government of Greece, President Harry S. Truman asked for, and received from Congress, \$400 million for military aid to Greece. In doing so, he announced what would be called the Truman Doctrine: “[I]t must be the policy of the United States to support free peoples who are resisting attempted subjugation by armed minorities or by outside pressures.”<sup>7</sup> Thus was the Cold War fully born.

But most important of all as a policy measure had been the Marshall Plan. Designed to halt the spread of communism in war-ravaged Europe, it promised to aid any nation “willing to assist in the task of recovery.” The Soviets disrespectfully declined to join. The plan worked. France and Italy, which had been in danger of going Communist, were saved for the West, and aid was extended to Austria and China. And finally, the United States, Canada, and the nations of Western Europe created the North Atlantic Treaty Organization, which coordinated their military organizations and pledged mutual assistance in the event of an attack on any one of them. The adversaries in the Cold War had been defined.

Almost coincidentally, George Kennan, writing as “X” in an article in *Foreign Affairs* analyzing Soviet conduct and U.S. response, used the word “containment.”<sup>8</sup> Almost immediately this became the term used to describe the emerging Truman Administration policy toward communism. This pragmatic realism was disturbing. Was communism to be legitimized in large parts of the world? Was the struggle to contain it to continue indefinitely? Would the struggle erupt into a war? It was an unsettling prospect.

Europe was not the only theater where communism needed to be contained. In the public mind, China was as important as Europe, and the policy of containment was not working there. Despite more than \$2 billion in grants and aid, the corruption-riddled Chiang Kai-Shek regime had not been able to stem the southward spread of Mao communism. In January 1949, the Nationalist government fled to Formosa; China had fallen to the Reds. Communism had been contained in Europe; in China it had burst through any containment attempt. Now the combination of China and the Soviet Union ruled more than a quarter of the earth’s surface and more than three-quarters of its people. The Nation, in early 1950, was shocked and fearful.

And it was not clear that communism was being contained on the domestic scene. While the trials of Communist Party leaders had proceeded and Government investigators traversed the country, the most important case occupying the public mind was that

---

<sup>6</sup> Ibid., 35.

<sup>7</sup> Ibid., 59-60.

<sup>8</sup> G. Kennan, “The Sources of Soviet Contact,” *Foreign Affairs*, July 1947.

of Alger Hiss, president of the Carnegie Endowment for International Peace and a past employee of the State Department. Hiss, that symbol of urbane Eastern intellectualism, of Ivy League education and genteel upbringing, friend and darling of the intellectual establishment, was being accused of espionage by Whittaker Chambers, a brilliant but “uncouth” editor of *Time*, and an avowedly reformed Communist. If Hiss, the confidant of the Nation’s leaders, could not be trusted, who could be? Was the Government riddled with Communist agents?

But above all, what contributed to the Nation’s nervousness was the bomb—or rather, Soviet possession of the bomb. When in September 1949 President Truman announced that the Soviets had exploded an atomic bomb, the Nation was dumbstruck. Despite the Smyth report<sup>9</sup> which explained the basic physics of the bomb and gave an account of the U.S. effort to build it, despite the warnings of the atomic scientists that any dedicated industrial nation could build the bomb, despite the estimate of those same scientists that the Soviet Union could build one in about five years, many of the public (including the president) believed that the U.S.S.R. would not have the bomb for a long time, perhaps ten years. Now here was the intransigent Soviet Union, at least five years ahead of schedule, possessor of the most deadly weapon devised by man.

The three blows of 1949—China, Hiss, and the bomb—had shocked the Nation. Goldman wrote:

[They] loosed within American life a vast impatience, a turbulent bitterness, a rancor akin to revolt. It was a strange rebelliousness, quite without parallel in the history of the United States. It came not from any groups that could be called the left, not particularly from the poor or the disadvantaged. It brought into rococo coalition bankers and charwomen, urban priests and the Protestant farmlands of the Midwest, longtime New Deal voters and Senator Robert A. Taft.<sup>10</sup>

And 1950 was to prove no anodyne. In January, Hiss was found guilty of perjury and led off to jail. When Secretary of State Dean Acheson avowed that he would not turn his back on Hiss, the public remembered that Truman had called the Hiss hearings a red herring. Was it really possible, as Congressman Richard Nixon averred, that “Traitors in high councils of our own government have made sure that the deck is stacked on the Soviet side . . .”?<sup>11</sup> The theme was picked up by an obscure junior senator from Wisconsin. Looking for a cause, he made several speeches charging that “there were 57 card-carrying members of the Communist Party in the State Department.”<sup>12</sup> Soon a new word, “McCarthyism,” was added to the English language.

---

<sup>9</sup> Henry D. Smyth, *Atomic Energy for Military Purposes, the Official Report on the Development of the Atomic Bomb Under the Auspices of the United States Government, 1940-1945* (Princeton, NJ: Princeton University Press, 1945).

<sup>10</sup> Goldman, *The Crucial Decade—and After*: 113.

<sup>11</sup> *Ibid.*, 135.

<sup>12</sup> *Ibid.*, 143.

On January 31, 1950, shortly after the Hiss conviction, President Truman announced almost laconically that he had “directed the Atomic Energy Commission to continue its work on all forms of atomic weapons, including the so-called hydrogen or super-bomb.”<sup>13</sup> A new and even deadlier arms race was under way, and scientists predicted that the Soviets would not be far behind. The specter of nuclear annihilation had become plainer.

Finally, on Saturday, June 24, while most of the Nation’s policy makers were away from Washington, North Korea mounted an all-out invasion of South Korea. The policy of containment was to receive its greatest military threat. Following three hectic days of conferences and meetings at the United Nations, President Truman announced that the U.S. Navy and Air Force would provide cover and air support below the 38th parallel for the South Korean forces. An electric feeling of cohesion gripped the Government. In three more days, having in the meantime secured the passage of a resolution committing other members of the UN to “furnish such additional assistance to the Republic of Korea as may be necessary to repel the armed attack and to restore international peace and security in the area,”<sup>14</sup> and facing a worsening military situation, Truman announced on June 30 the commitment of U.S. troops in Korea. The Cold War had become hot.

### THE STATE OF SCIENCE

It is tragically true that some persons, and some fields of endeavor, are beneficiaries of war. This was the case with science. It came out of the war bigger and more famous than ever before. The atomic bomb had focused the public’s attention on science, and the Smyth report told that story with thriller-novel intensity. And the achievements of science went beyond the atomic bomb. Radar and sonar became household words. News of the proximity fuze, which enormously extended the effectiveness of bombs and artillery shells, became generally known and was considered by some to be a military development as important as the bomb. A whole new industry—synthetic rubber—had been built and was turned over to industry. Penicillin and DDT were viewed as boons to mankind. Advances in electronics helped to make TV and that new commercial rage, “hi-fi,” better. The jet airplane, while having no decided effect during the war, was becoming of overriding military importance, and in 1952 the ill-starred Comet aircraft was to usher in the age of commercial jet air transportation. And atomic energy held the promise—or fantasy—of electricity so cheap that it would not need to be metered. Scientists—particularly physicists—were looked upon with awe.

In keeping with its successes, the support of science—both Federal and private—had increased dramatically. From a total in 1940 of \$250 million, national research expenditures had risen to \$1.1 billion in 1945, and in 1950 were estimated to become \$1.75 billion.<sup>15</sup> Whole new laboratories—denoted as National laboratories after the

---

<sup>13</sup> Ibid., 135-136.

<sup>14</sup> Ibid., 160.

<sup>15</sup> Eric A. Walker, “Effects of Government Support on Scientific Research,” *Bulletin of the Atomic Scientists* 7(4) (1951): 119. See also graphs in Appendix E.

control of atomic energy was transferred to civilian hands with the creation of the Atomic Energy Commission in 1946—had been formed: Livermore; the famous Los Alamos, now a household name; Sandia, for weapons research; Argonne; Brookhaven; Idaho; Berkeley; Oak Ridge; Hanford; and, later, Fermilab for basic research in nuclear and particle physics and more general programs. The mix of spending had, of course, changed dramatically. While in 1940 the portion of research and development expenditures devoted to the military was approximately 6 percent, by 1945 the portion had inevitably risen to somewhat more than 50 percent, and the Korean War promised a new spurt of military research expenditures. The military had discovered science, found it useful (indeed essential in these Cold-War days) and a new symbiosis had arisen. The point of view of the military was succinctly and accurately expressed by Major General Curtis E. LeMay—no desk-bound general—in a letter to Edward Uhler Condon, director of the National Bureau of Standards, on January 4, 1946:

I have no doubt that many a scientist has breathed a sigh of relief that they may now return to “normal” pursuits. But the Army Air Forces have learned to depend on you people, and realize that we cannot get along without your continued assistance. I most sincerely hope that the partnership developed during the war will be continued in the days to come.<sup>16</sup>

During the war, Government activities in science—and that amounted to essentially the whole national scientific effort—were guided by a set of interlocking committees in the National Defense Research Committee (NDRC) and the Committee for Medical Research. These in turn reported to the Office of Scientific Research and Development (OSRD), essentially a holding company for all Federal research activities, and headed by Vannevar Bush. Two items in that structure were of critical importance. The system of interlocking committees was a collegial structure that scientists were accustomed to and comfortable with. This was a great inducement for scientists to come to work for the Government, although patriotism should not be discounted. Perhaps even more important, the OSRD was located in the Office of the President, and its director had direct access to the president. This gave Bush enormous clout when dealing “with the vast network of administrative relationships on which the success of a Government agency depends.”<sup>17</sup>

Even well before the end of the war, it was clear that this structure, devised for the emergency, could not be extended into the postwar period and, in 1944, President Roosevelt had written to Bush asking him to address four questions which can be paraphrased as follows:

---

<sup>16</sup> NARA; RG 167; Director's Files; Box 2; Folder D/IDP (Part 1).

<sup>17</sup> Don K. Price, *Government and Science: Their Dynamic Relationship in American Democracy* (New York: New York University Press, 1954): 45.

1. Consistent with national security, what can be done to make known to the world the contributions made to scientific knowledge during the war effort?
2. What can be done for continuing into the future the war against disease?
3. What can the Government do now and in the future to aid research activities by public and private institutions?
4. Can an effective program be proposed for discovering and developing scientific talent?

After study by four committees, Bush submitted his report on July 15, 1945,<sup>18</sup> to President Truman, Roosevelt having died in the interim. He proposed the creation of a National Research Foundation consisting of five divisions: Medical Research, Natural Sciences, National Defense, Scientific Personnel, and Publications and Scientific Collaboration. The emphasis was to be primarily on basic research,<sup>19</sup> and work was to be supported in research outside the Government, primarily in universities. In its scope, the proposal that the Government support basic research for the health and economic well-being of the Nation rivals the decisions of the mid to late nineteenth century for Government support of agricultural research. A major turning point in the conduct of science in the United States was at hand.

Significantly, Bush's report proposed that the Foundation be headed by a board of members not otherwise connected with the Government, and that this board would choose its own executive director. This was recommended to assure "complete independence and freedom for the nature, scope, and methodology of research carried on in the institutions receiving public funds."<sup>20</sup> In retrospect this appears a naive recommendation. It is difficult to believe that any president would work on policy matters with a person he did not appoint. Thus, when Truman received a bill in 1947 proposing the establishment of this organization (now called the National Science Foundation) that contained this provision, he promptly vetoed it. "They offered a national science bill which eliminated the President from the Government of the United States, and I wouldn't sign it," said Truman speaking of his favorite whipping boy, the Eightieth Congress, when addressing the American Association for the Advancement of Science (AAAS) on September 13, 1948.<sup>21</sup> The veto was not unexpected. However, another bill giving the president power to appoint an executive director and a twenty-four-member board for the Foundation was passed by the Congress and signed into law in 1950.

---

<sup>18</sup> Vannevar Bush, *Science, The Endless Frontier: a Report to the President on a Program for Postwar Scientific Research, July 1945* (Washington: National Science Foundation, 1960 reprint). This report was commissioned almost a year before the fall of Germany, was submitted a full two months before the Japanese surrender, and only two months after the surrender of Germany. Clearly Roosevelt had been concerned very early with the problems of the postwar Nation.

<sup>19</sup> For a dissenting view, see Deborah Shapely and Rustum Roy, *Lost at the Frontier* (Philadelphia: ISI Press, 1985).

<sup>20</sup> Bush, *Science, the Endless Frontier*: 33.

<sup>21</sup> "President Truman Speaks to the Scientists," *Bulletin of the Atomic Scientists* 4(10) (1948): 291-293.

This bill did not include provisions for military research since this clearly was being handled by other means, and the provisions for medical research were made redundant by the flourishing of the National Institutes of Health. However, the bill gave the Foundation two further responsibilities: the development of science policy, and the evaluation of research programs undertaken by agencies of the Federal Government. The Foundation could carry out the first of these, but only in basic research. The second was an unrealistic expectation and was carried out only tangentially.<sup>22</sup>

The principal emphasis of the Bush report was basic research. In his introduction to the Bush report Alan Waterman wrote:

Basic research leads to new knowledge. It provides scientific capital. It creates the fund from which the practical applications of knowledge must be drawn. . . . Today, it is truer than ever that basic research is the pacemaker of technological progress. . . . A nation which depends upon others for its new basic scientific knowledge will be slow in its industrial progress and weak in its competitive position in world trade, regardless of its mechanical skill.<sup>23</sup>

And again,

The distinction between applied and pure research is not a hard and fast one, and industrial scientists may tackle specific problems from broad fundamental viewpoints. But it is important to emphasize that there is a perverse law governing research: under the pressure for immediate results, and unless deliberate policies are set up to guard against this, *applied research invariably drives out pure.*

This moral is clear: It is pure research which deserves and requires special protection and specially assured support.<sup>24</sup>

That basic research was a principal concern arose from two important considerations, especially in nuclear physics. Under the pressure of building the atomic bomb, the basic knowledge gleaned in the research of the 1920s and 1930s had been used up and not replaced. The capital had been spent. In the words of Philip Morrison: “[Science] was mobilized with fierce single-mindedness for war. Not even a good seed crop was left in the schools.”<sup>25</sup> What was true in nuclear physics was also true in other branches of science. The storehouse of knowledge had been raided, and needed to be refilled.

Moreover, the European universities, which had trained many leading American scientists, were a shambles. The great schools of physics on the continent were gone, their professors scattered to the winds, which fortunately had blown toward the United States. And basic research, again particularly in nuclear physics, had become more

<sup>22</sup> Alan T. Waterman, introduction to *Science, the Endless Frontier; a Report to the President on a Program for Postwar Scientific Research*, by Vannevar Bush, July 1945 (Washington: National Science Foundation, 1960 reprint): xxiii.

<sup>23</sup> *Ibid.*, viii. In this day (1994) of enormous trade deficits with Japan, which has the reputation of doing very little basic research, these statements indicate that something was missing from the prescription. See Shapely and Roy, *Lost at the Frontier*, for a dissenting opinion.

<sup>24</sup> *Ibid.*, xxvi.

<sup>25</sup> Philip Morrison, “The Laboratory Demobilizes. . . .” Address at the Atomic Energy Session of the *New York Herald-Tribune Forum*, October 29, 1946, reprinted in *Bulletin of the Atomic Scientists* 2(9/10) (1946): 5-6.



expensive,<sup>26</sup> and was to continue to do so. In these days of cyclotrons, synchrotrons, betatrons, and nuclear reactors, facilities had become so costly that they had to be shared among research workers. This trend was to continue as new and more sophisticated laboratory equipment was developed. And in nuclear physics, research was carried out by large groups of investigators at large, expensive facilities. Basic research was essential to the economic and military future of the Nation and the Government was the only entity that had the resources and the necessary long-term view, went the argument. It had to support basic research.

Yet in the years between 1946 and 1950, while the debates about the structure of the NSF went on, no mechanism was available to fund civilian basic research outside the realm of atomic energy, and most of that was directed toward weapons problems. Enter then the Office of Naval Research.<sup>27</sup> In what must surely be one of the most enlightened research-support decisions ever made by a military agency, the Navy Department, reasoning that advances in basic science were essential to the future capabilities of the Navy, in 1946 formed the Office of Naval Research, setting it up on the same level as one of its statutory Bureaus. In the years between its founding and the establishment of the NSF in 1950 it had become the principal supporter of basic research in the Nation, and in those years did the work envisaged for the NSF. Aside from its own work carried out in three Navy laboratories, in 1949 it had 1131 projects at more than 200 institutions. This accounted for more than 40 percent of the Nation's total expenditures in basic science, and the total of \$43 million amounted to more than the total national expenditure for basic research in 1941. Giving the contracting scientists a maximum degree of freedom, it received four times as many applications for projects as it could finance. Among many others, it financed projects in low-temperature physics, mathematics, investigations of cosmic rays, meteors, white dwarf stars, viruses, and the structure of proteins. It also supported work in the rapidly emerging field of computers, although it did this not as part of its support of basic research, but as part of its military-directed work. Its director was Alan T. Waterman, who, in 1950, became the first director of the NSF.

Following World War II, science did not wait for the National Science Foundation to be formed to make progress. Indeed, the period between the end of the war and 1950 showed notable advances in both basic science and technology. Some of these advances will be noted here. In basic physics, Willis Lamb of Columbia University reported at a conference at Shelter Island in 1947 that the  $2^2S_{1/2}$  and  $2^2P_{1/2}$  states of hydrogen differed in energy by a small amount, in stark contrast to the predictions of

---

<sup>26</sup> Lee A. DuBridge, "The Role of Large Laboratories in Nuclear Research." A speech given at the Bicentennial Celebration of Princeton University; reprinted in *Bulletin of the Atomic Scientists* 2(9/10) (1946): 12-13.

<sup>27</sup> John E. Pfeiffer, "The Office of Naval Research," *Scientific American* 180(2) (1949): 11-15.

first-principle theory. This report—the third paper by Lamb on the topic—caused an immediate sensation. In the words of Abraham Pais, “it was clear to all that a new chapter in physics was upon us.”<sup>28</sup> Following this conference, Hans Bethe, Julian Schwinger, Sin-Itiro Tomonaga, and particularly Richard Feynman, all working independently, derived the so-called Lamb shift, and in the process created quantum electrodynamics, the most accurate physical theory ever developed. A year later, in a more technologically oriented physics area, John Bardeen, Walter H. Brattain, and William Shockley produced the transistor,<sup>29</sup> thereby laying the basis for a revolution in communications and computers, and in the process revolutionizing society. And computers themselves were showing great advances. John von Neumann began his seminal theoretical studies; J. Presper Eckert and John W. Mauchly in 1946 produced ENIAC, the first all-purpose electronic computer; the National Bureau of Standards in 1949 produced SEAC, then the fastest general-purpose, automatically-sequenced, electronic computer. The computer “explosion” had begun. Partly helped by computers, and soon to be helped more, the elucidation of structures by x-ray diffraction made great strides. By the use of ingenious techniques, structures previously thought intractable were being handled in both organic and inorganic materials, and this would culminate in the determination of the structure of proteins with resolutions as small as atomic diameters. A far more basic understanding of the phenomena of life was in the offing. An enormous leap in this direction was soon to come. The molecular basis of genetics was being sought by many workers, and finally found in the DNA double helix by James D. Watson and Francis H. C. Crick in 1953. The science of microbiology was born, and genetic engineering, its manufacturing offspring, would follow. Other scientific and technological advances were to have profound effects such as: the publication in 1948 by Claude Shannon of his work in information theory; the development by Willard Libby in 1948 of the carbon-14 method of dating archeological artifacts; the development in the same year by the National Bureau of Standards of the atomic clock, a variant of which was in due course to replace our slightly wobbly earth as a timekeeper; the development in 1948 by George Gamow, Ralph Alpher, and Robert Herman of the “Big Bang” theory of the origin of the universe, which was to revolutionize cosmology and have profound effects on philosophy and religion; and the production of Orlon by Dupont, thereby, with Nylon and Dacron, completing the triad of synthetic fibers that were designed to replace the natural triad of wool, silk, and cotton, and did so with considerable success. Many more examples could be added to this list. Clearly, basic and applied science were not static.

---

<sup>28</sup> Abraham Pais, *Inward Bound; Of Matter and Forces in the Physical World* (Oxford: Clarendon Press, 1986): 451. Chapter 18 gives an excellent historical and technical account of the origins of quantum electrodynamics.

<sup>29</sup> In 1965, Feynman, Schwinger, and Tomonaga shared the Nobel Prize in Physics “for their fundamental work in quantum electrodynamics, with deep-ploughing consequences for the physics of elementary particles,” and in 1956 Bardeen, Brattain, and Shockley shared the Nobel Prize in Physics “for their investigations on semiconductors and the discovery of the transistor effect.”

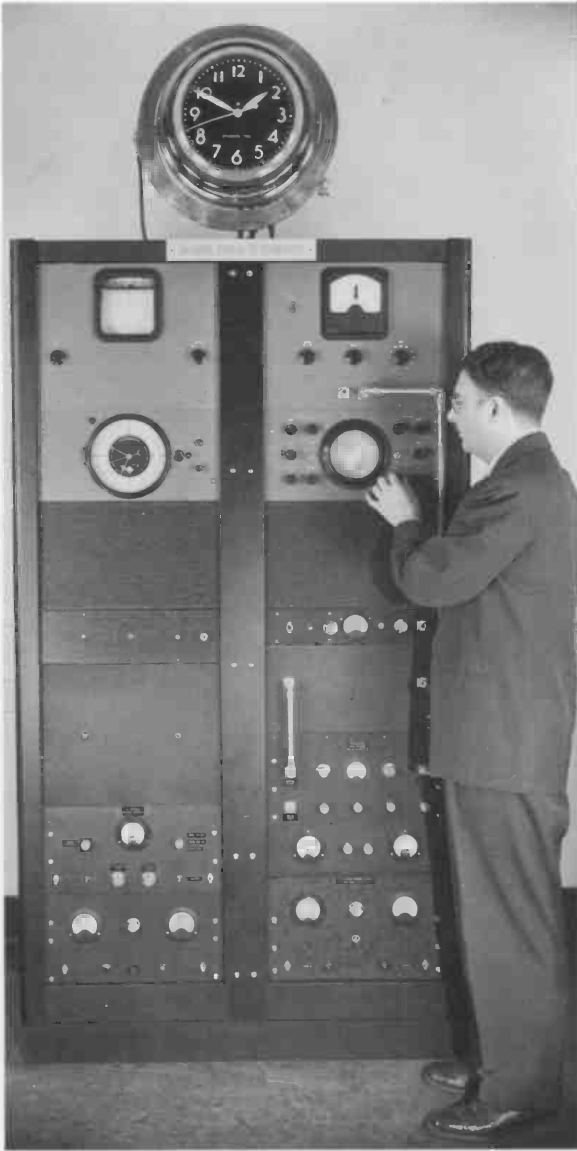

Harold Lyons observed the first atomic-beam clock developed in 1948 by NBS. Really a molecular clock, the device was based on the microwave absorption line of ammonia.

Those scientists who worked on atomic energy and military problems, however, faced new concerns: security and loyalty questions. The intense national anxiety with communism and subversion, and the vain attempt to maintain a military atomic monopoly, put a much greater demand on all those working in classified areas. Thus, when on August 1, 1946, the control of atomic energy passed from military to civilian hands with the formation of the Atomic Energy Commission, Section 10 of the act that formed the Commission contained the following paragraph:

Except as authorized by the Commission in case of emergency, no individual shall be employed by the Commission until the Federal Bureau of Investigation shall have made an investigation and report to the Commission on the character, associations and loyalty of such individual.<sup>30</sup>

This immediately raised concerns about "guilt by association." The concerns were not eased when President Truman issued Executive Order 9835 on March 25, 1947. This order provided for the loyalty investigation of "every person entering the civilian employment of any department or agency of the executive branch of the Federal Government," and directed that "The head of each department and agency in the executive branch of the Government shall be personally responsible for an effective program to assure that disloyal civilian officers or employees are not retained in employment in his department or agency." Among the "activities . . . which may be considered in connection with the determination of disloyalty . . ." were the following:

Membership in, affiliation with or sympathetic association with any foreign or domestic organization, association, movement, group or combination of persons, designated by the Attorney General as totalitarian, fascist, communist, or subversive, or as having adopted a policy of advocating or approving the commission of acts of force or violence to deny other persons their rights under the Constitution of the United States, or as seeking to alter the form of government of the United States by unconstitutional means.<sup>31</sup>

Again the question of guilt by association was raised and caused the publication of the famous "Attorney General's List" of subversive organizations. The rigors of this loyalty clearance and the occasional harassment that accompanied it kept some persons from seeking employment in the Government, and some employees to resign. The number of these persons is unknown, but there is little question that the Government lost some valuable people.

While loyalty clearances were being carried out, the House Committee on Un-American Activities was also doing its work, travelling from coast to coast investigating avowed or suspected communists. National headlines were made when, without hearings and based solely on a report by a sub-committee headed by Rep. J. Parnell Thomas of New Jersey, who was also chairman of the full committee, the committee announced that Edward U. Condon, director of the National Bureau of Standards, was "one of the weakest links in our atomic security." The report contained no evidence to substantiate such a charge. This caused a spate of negative editorial

---

<sup>30</sup> *Atomic Energy Act of 1946, U.S. Statutes at Large*, 60 (1946): 767.

<sup>31</sup> President, Executive Order 9835, *Federal Register* 12, no. 59 (25 March 1947): 1935-1939.

opinion, against Congressman Thomas and great indignation in the scientific community, particularly among scientists who worked on the atomic bomb, many of whom were close personal friends of Condon. The trauma produced by these loyalty investigations was not to be healed for almost ten years. By that time both Robert Oppenheimer and Condon would be stripped of their security clearances.

## A UNIQUE INSTITUTION

In 1950, the headquarters of the National Bureau of Standards was located on sixty-eight gently hilly acres on the west side of Connecticut Avenue, overlooking the intersection with Van Ness Street in northwest Washington, District of Columbia, 3.5 miles north of the White House. While most of the Bureau's work was carried out at this headquarters site, it also had work going on at twenty-three other locations. Four materials testing stations, primarily for the testing of cement purchased by the Government, were located in Allentown, Pennsylvania; Seattle, Washington; Denver, Colorado; and San Francisco, California. Two proving grounds for testing weapons and components under development, operated in LaPlata, Maryland, and Tuckerton, New Jersey. A railway-scale test car was based in Clearing, Illinois, and a lamp-inspecting station to certify Government purchases was located in Brookline, Massachusetts. Research in applied mathematics was carried out at the Institute for Numerical Analysis at UCLA as well as at the headquarters site. Radio wave propagation activities were conducted at nine field stations that pretty much spanned the Northern Hemisphere: Anchorage, Alaska; Point Barrow, Alaska; Guam; Honolulu; Puerto Rico; Trinidad; Fort Belvoir, Virginia; Las Cruces, New Mexico; and Sterling, Virginia. These stations provided data on the ionosphere, which formed the basis for monthly forecasts of radio propagation conditions. NBS operated two radio stations that broadcast standard time and frequency signals that were used as both time and frequency standards. These signals were the basis for setting clocks and were widely used for navigation, for setting the frequencies of broadcast stations, and any other uses in which accurate frequency control was important. One station, WWV, located in Beltsville, Maryland,<sup>32</sup> covered the continental United States while another, WWVH,

---

<sup>32</sup> WWV locations have included the Bureau's Van Ness site (1923-1931), College Park, Maryland (1931-1932), Beltsville, Maryland (1932-1966. The location name of Beltsville was changed to Greenbelt in 1961.), and Fort Collins, Colorado (1966 to the present). Wilbert F. Snyder and Charles L. Bragaw, *Achievement in Radio: Seventy Years of Radio Science, Technology, Standards, and Measurement at the National Bureau of Standards*, Natl. Bur. Stand. (U.S.) Special Publication 555; October 1986: 277, 282.



Aerial view of the Washington, D.C. laboratories of the National Bureau of Standards (1952).

on Maui in the Hawaiian Islands, covered the Pacific Ocean. In addition, the Bureau was in the process of acquiring 200 acres in Boulder, Colorado, donated by the citizens of that city, and was making plans to construct a guided-missiles laboratory, which was in due course built in Corona, California.

The total staff working in these locations was 3100, with a total budget of \$20 million, approximately 43 percent coming from direct congressional appropriation, the remainder being funds transferred from other agencies of the government, primarily the military.<sup>33</sup> As did the rest of science, NBS had experienced explosive growth during

---

<sup>33</sup> The Bureau is authorized to carry out work on contract for other agencies of the Government. In the vernacular of the institution these are called "other agency," or simply OA, funds.



Field Station at Elmendorf Air Force Base, Anchorage, Alaska, one of several NBS field stations that gathered and disseminated data on the ionosphere.

the war years. In 1941 it had a staff of 1032 and a budget of \$3.37 million, 60 percent of which was directly appropriated and the remainder again transferred from other agencies. By 1945 the staff had risen to 2206 and the budget to \$9.7 million, but only 33 percent was appropriated.<sup>34</sup> Throughout this whole period the Bureau was doing so much work for the military that it was in danger of losing its identity as the Nation's standards laboratory.<sup>35</sup> And the situation was to get worse. Already in fiscal year 1950, its direct appropriations from the Congress dropped from \$8.753 million for the previous year to \$8.658 million, and the downward trend was to continue.<sup>36</sup> In 1952, under

<sup>34</sup> NARA; RG 167; Astin file; Box 5; Folder Kelly Committee.

<sup>35</sup> For a complete accounting of the Bureau's military work during World War II, see MFP, chapter 7, and Lyman J. Briggs, *NBS War Research, The National Bureau of Standards in World War II* (Washington, D.C.: U.S. Department of Commerce, 1949).

<sup>36</sup> See graphs in Appendix E.



Exterior of NBS radio broadcasting station WWV, Greenbelt, Maryland. From this station, standard radio frequencies of 2.5, 5, 10, 15, 20, and 25 Mc were transmitted continuously. Two standard audio frequencies, 600 and 400 cycles, were broadcast as modulations on each radio frequency.

pressure of work related to the Korean War and other military research, a full 80 percent of the then \$53 million budget was provided by the military, and the total staff had risen to 4450. The Bureau was in danger of becoming an appendage of the military establishment, its own legislatively mandated work lost in a sea of weapons research.

Although its mode of operation was as much collegial as hierarchical, the Bureau's staff of 3100 persons was organized in the simplest of hierarchical structures that had not changed in the forty-nine years of its existence. Fourteen divisions, containing a total of 107 sections (the smallest operational unit), carried out all the technical work. These were supported by four support divisions: Budget and Management, Personnel, Plant, and Shops. All the division chiefs reported directly to the director; there were no intervening levels. The Director's Office contained two associate directors, two assistant directors, the Bureau library, and an Office of Scientific Publications, responsible for the mechanics of publication of scientific papers, reports, special publications, circulars, and the other publications that constituted the Bureau's most important output.<sup>37</sup> A listing of the names of the divisions, with the number of their sections, illustrates the areas of work and gives some idea of the distribution of effort:<sup>38</sup>

<sup>37</sup> During its history, the Bureau has issued many types and series of publications. These are described in Appendix H.

<sup>38</sup> This listing is as of July 1, 1950. Before this date Optics was combined with Electricity in the Electricity and Optics Division; the Electronics Standards Laboratory, Ordnance Development Laboratory, and Guided Missile Branch were combined in the Electronics and Ordnance Division; and the Commodity Standards Division had not yet been transferred to the Office of Science and Technology in the Department of Commerce.





Personnel who directed the development of the BAT, the first fully automatic guided missile used in combat. In 1942, the National Defense Research Committee asked NBS to handle the aerodynamic and servo-mechanism aspects of the missile. Hugh Dryden (third from right) supervised the Bureau's effort. Other NBS personnel pictured are Harold K. Skramstad (left), W. Hunter A. Boyd (second from right), and Ralph A. Lamm (right).

Electricity (5), Optics and Metrology (5), Heat and Power (6), Atomic and Radiation Physics (13 in two laboratories: Atomic Physics and Radiation Physics), Chemistry (11), Mechanics (7), Organic and Fibrous Materials (7), Metallurgy (4), Mineral Products (8), Building Technology (5), Applied Mathematics (4), Electronics (3), Ordnance Development (8), Central Radio Propagation Laboratory (7 in three laboratories: Ionospheric Research, Systems Research, Measurement Standards, plus 12 field stations), and Missile Development (5).

The program was extremely broad, ranging from studies in superconductivity to atomic clocks, synthetic rubber, cement testing for Government purchases, atomic spectra, methods of measuring radioactivity, computers, and a great deal of work on military hardware, including proximity fuzes and guided missiles.

## THE NATURE AND CHARACTER OF THE BUREAU

The Bureau was not nearly so grand when it officially began operations on July 1, 1901, the law (the "Organic Act") that established it having been enacted on March 3, 1901. In that law the Congress, in carrying out its constitutional authority "to fix the standards of weights and measures"—the march of industrial development had nearly made this an obligation—had charged the new Bureau with:

the custody of the standards [of measurement]; the comparison of the standards used in scientific investigations, engineering, manufacturing, commerce, and educational institutions with the standards adopted or recognized by the Government; the construction, when necessary, of standards, their multiples and subdivisions; the testing and calibration of standard measuring apparatus; the solution of problems which arise in connection with standards; the determination of physical constants and the properties of materials, when such data are of great importance to scientific or manufacturing interests and are not to be obtained of sufficient accuracy elsewhere.

The law goes on to direct for whom the Bureau should work:

the Bureau shall exercise its functions for the Government of the United States; for any State or municipal government within the United States; or for any scientific society, educational institution, firm, corporation, or individual within the United States engaged in manufacturing or other pursuits requiring the use of standards or standard measuring instruments.

Clearly, the Bureau was to serve the whole society.<sup>39</sup>

By this law, the Bureau became one of a number of national laboratories established by industrial nations at the end of the nineteenth century and the beginning of the twentieth. Perhaps the foremost amongst them was the German Physikalisch-Technische Reichsanstalt which, in some ways, Samuel Wesley Stratton, the Bureau's first director, used as a model for his institution.<sup>40</sup> In the late nineteenth century, the inexorable march of the industrial revolution, the expansion of science, and the requirements of national and international trade made mandatory a worldwide system of units of measurements and their associated standards. Indeed, in 1875, the *Convention du Mètre*, known in the United States as the Treaty of the Meter, was signed in Paris by the United States and seventeen other countries. By this treaty, the signatory nations adopted the meter and kilogram as legal units of length and mass. The international prototype standards for these units were to be maintained at the International Bureau of Weights and Measures (BIPM), located on extra-territorial land near Sèvres, France, and the United States was allotted copies Nos. 21 and 27 for the meter, and Nos. 4 and 20 for the kilogram. They were received in January 1890. The

<sup>39</sup> *An Act to establish the National Bureau of Standards, U.S. Statutes at Large*, 31 (1901): 1449. Full text in Appendix C.

<sup>40</sup> The following statement appears in the director's annual report for 1902, the first in the Bureau's history: "The Physikalisch-Technische Reichsanstalt of Germany is an illustrious example of how much can be accomplished where research and testing are combined in one institution." *Annual Report of the Director*, (1902): 5.



Samuel Wesley Stratton, first director of the National Bureau of Standards, was the primary force in the Bureau's creation and formative years. He established a solid basic research program and organized young scientists into cooperative efforts of applied science that shaped the Bureau to serve the Nation.

customary units of the yard and the pound were defined as 3600/3937 meter and 0.453 592 427 7 kg, respectively.<sup>41</sup> Indeed, the Congress had authorized the legal and permissive use of the metric system in 1866, using standards obtained from France in 1821. The secretary of the treasury, in whose department the Office of Weights and Measures was located, was directed to supply the states with sets of standard metric weights and measures. To this day, the customary units of the yard and the pound have not been legalized, which causes no problems since their relation to the legal standards is fixed.<sup>42</sup>

Perhaps even more important, the burgeoning electrical industry showed that simple standards for mass, length, and time were no longer sufficient. Standards for quantities barely known to the layman, such as volts, amperes, farads, henries, and most

<sup>41</sup> Ralph W. Smith, *The Federal Basis for Weights and Measures*, Natl. Bur. Stand. (U.S.) Circular 593; June 1958: 15.

<sup>42</sup> For a full and excellent account of these matters, see Rexmond C. Cochrane, *Measures for Progress: A History of the National Bureau of Standards*, Natl. Bur. Stand. (U.S.) Miscellaneous Publication 275, 1966: Appendix B. Hereafter referred to as MFP.



The platinum-iridium cylinder (right) is the primary standard kilogram for all metric measurements of mass in this country. Known as Kilogram No. 20, it is a copy of the international prototype kilogram, which is preserved at the International Bureau of Weights and Measures (BIPM) at Sèvres, France. Kilogram No. 4 (left, under double bell jar), a duplicate of No. 20, is used as a secondary standard.

important, kilowatt-hours, that being the unit by which electricity was sold, had to be developed and made uniform throughout the Nation and the world. X rays and radioactivity had only recently been discovered, and both units and standards for them had to be devised. All of these required research, in most cases basic research into new areas of physics and chemistry. The simple offices of weights and measures had to be replaced with more sophisticated institutions.

Compared to the adult institution it would become in 1950, when the Bureau began operation as part of the Treasury Department it was only a tiny infant. It started in temporary quarters in three buildings just south and east of the Capitol: eight rooms formerly used by its predecessor, the Office of Weights and Measures, in the Coast and Geodetic Survey building; eight additional rooms in the adjacent Butler Building; and a remodeled residence down the street from them. Its authorized staff, aside from its director, consisted of twenty-two people in three divisions: Scientific, Engineering, and Office. There was one physicist, two assistant physicists, five laboratory assistants, four laborers (one skilled), one engineer, one assistant engineer, two mechanics, one watchman, one secretary, two clerks, one storekeeper, and one messenger. Its total budget was about \$67 000.

Still in its fledgling stage, the work of the new Bureau was concerned with the central part of its basic mission: providing the standards of measurement and the comparison of the standards used in scientific investigations, engineering, manufacturing, and commerce with the national standards. In fact, in the first year of its operation, the Bureau carried out little more than its basic weights and measures functions. But it was making plans for the future, both with respect to facilities and with respect to the technical work. Thus, 7.5 acres (3 hectares) at the Connecticut Avenue site had been chosen, and plans for a physical laboratory building and a mechanical laboratory building were being drawn. The latter building was to contain the power plant as well as heavy items of research equipment, and specifications were being drawn for either the purchase or construction of necessary laboratory instruments.

With respect to the technical work, a large number of standards for mass, length, and capacity (volume) were verified (i.e., compared to the national standards) for Federal and state governments and for private concerns. Considerable effort was devoted to improving the instruments used for this comparison in order to speed up this rather routine but essential activity. The need for higher accuracy of comparison was strongly felt. Three items were particularly troublesome. First was the calibration of chemical glassware for volume. This had to be done by the individual chemists, or the glassware purchased from Germany, whence it came certified by the Physikalisch-Technische Reichsanstalt (PTR). Second was "the design and construction of a model set of weights and measures that shall be adapted to the needs of State, county, and city sealers."<sup>43</sup> Previous sets had been provided in 1836 and 1866, and were no longer adequate to meet new requirements. Finally, there was considerable confusion with respect to the calibration of hydrometers, and this had to be cleared up. These problems now seem almost quaint and charming, and are a vivid reminder of the state of technological development of the Nation at the turn of the century.

The problems were even greater outside the realm of weights and measures. In thermometry, mercury-in-glass thermometers could be calibrated only over the temperature range from  $-20^{\circ}\text{C}$  to  $50^{\circ}\text{C}$ , which was totally inadequate for the times. The Bureau was making plans to extend the calibration range to  $1500^{\circ}\text{C}$  on the high end, and to  $-190^{\circ}\text{C}$  on the lower end, the latter made necessary by the recent large-scale liquefaction of air and other gases.

While hardly well-equipped, the Bureau was making progress in electrical standards. It had purchased resistance standards from 0.0001 to 100 000 ohms. Comparison equipment (presumably bridges) had been purchased "so that the Bureau is already equipped for the measurement of resistance standards submitted for verification *in terms of those belonging to the Bureau* to the highest order of accuracy."<sup>44</sup> (Italics added.) But the need for a primary standard was sorely felt, and the construction of the mercury column of specified dimensions that had been defined by the International Electrical Congress of 1893 as the unit of resistance, and legalized by the Congress, was begun. The Nation was in the strange position of having legalized a standard for resistance that it did not own.<sup>45</sup>

The situation with the volt was in some ways similar. The Bureau had constructed several Clark electrolytic cells that constituted the legal definition of the volt, but research was already under way to find more reproducible and stable cells. Nevertheless,

---

<sup>43</sup> Annual Report, 1902: 10.

<sup>44</sup> *Ibid.*, 12. It is not stated where the resistance standards were obtained. It is known that several 1 ohm resistors were obtained from Germany, and periodically checked against the PTR primary standard (MFP, p. 79). Presumably the other resistors also came from the PTR, but they could have been made by the Bureau.

<sup>45</sup> *An Act to Define and Establish the Units of Electrical Measure, U.S. Statutes at Large*, 28 (1894): 101. Following their adoption by the International Electrical Congress in 1893, the U.S. Congress made legal the units adopted by that congress. The units so legalized were the ohm (resistance), the ampere (current), the volt (electromotive force), the coulomb (quantity), the farad (capacity), the joule (work), the watt (power), and the henry (inductance). These were called the "international units." Their relation to absolute units were a source of continuing research.

the Bureau could carry out calibrations with respect to the legal volt. Ammeters and voltmeters could, however, be calibrated only up to 50 amperes and 150 volts, but preparations were being made to extend this range to 1500 amperes and 2000 volts. But these were only direct current measurements. Alternating current was becoming more and more popular for the transmission of electricity, so the Bureau was establishing an alternating current laboratory. Along with that came the problems of the determination of capacitance and the calibration of standards of self and mutual inductance.

Finally a photometry laboratory was established, and work in this difficult but essential field was begun. With the veritable explosion of incandescent lighting, there was considerable pressure for measurement standards for illumination.

This was the organization that developed into the National Bureau of Standards of 1950, with a site on which existed 138 structures (in fairness, some of them quite small) and with field stations spanning the Northern Hemisphere. It looked upon itself quite correctly as being far more than a simple office of weights and measures. In the opening words of its Annual Report for 1950 it describes itself as follows:

The National Bureau of Standards is the principal agency of the Federal Government for basic and applied research in physics, mathematics, chemistry, and engineering. In addition to its general responsibility for basic research, the Bureau undertakes specific research and development programs, develops improved methods for testing materials and equipment, determines physical constants and properties of materials, tests and calibrates standard measuring apparatus and reference standards, develops specifications for Federal purchasing, and serves the Government and the scientific institutions of the Nation in an advisory capacity on matters relating to the physical sciences. The Bureau also has custody of the national standards of physical measurement, in terms of which all working standards in research laboratories and industry are calibrated, and carries on necessary research leading to improvement in such standards and measurement methods.

The seeds of the growth and metamorphosis from a glorified office of weights and measures into a full-fledged, broad-based, internationally known and respected scientific laboratory were contained in the Organic Act. The Act contains the wonderfully ambiguous phrase that directs the Bureau to work on "the solution of problems which arise in connection with standards," and the less ambiguous but equally open-ended phrase authorizing the Bureau to engage in "the determination of physical constants and the properties of materials, when such data are of great importance to scientific or manufacturing interests and are not to be obtained of sufficient accuracy elsewhere." Placed in the law at the instigation of Stratton, both phrases are permissive;<sup>46</sup> they can encompass an almost endless scope of work.

---

<sup>46</sup> This word to describe the Organic Act appears to have been first used by Robert D. Huntoon in an unpublished report to Edward L. Brady, June 1977, on the nature and character of the Bureau. A number of other ideas in that perceptive report stimulated some of the discussion which follows.

The resulting breadth of work was crucially important in determining the character of the Bureau. It had the permission, if not the obligation, to become the principal agency in the Federal Government for basic and applied research.<sup>47</sup>

Equally important, although perhaps not so obvious at first blush, is that the Organic Act gave the Bureau no regulatory—policing—responsibility or authority. While it was charged with defining the unit of mass, for example, it had no authority to go to a manufacturer of scales to determine whether his scales were accurate—in accordance with the national units—or not. This is a crucial point that ultimately controls the nature of the institution that evolves from the central standards and measurement function. If called upon, it can be the final arbitrator in disputes relating to the validity of measurements, but it cannot be the instigator of disputes. This is left to other agencies of state and Federal Government. And the arbitration function is not that of listening to the testimony of plaintiff and defendant and then issuing a judgement. The function is rather that of determining scientific truth: what is the actual value of the quantity in question and what are the limits of uncertainty in the knowledge of that value? What is in fact known or can be known, and with what uncertainty? Its judgment is a scientific judgment, not a legal one, and the arena where scientific truth is sought is the laboratory, not the courtroom, for no scientific result is accepted as fact until it has been exhaustively confirmed. But this arena is not without its own appellate courts. These are the courts of public opinion, scientific scrutiny, and politics. An institution, if it is to function effectively in such an arena, must be, and must be perceived to be, objective, impartial, and totally unbiased. Moreover, if its pronouncements are to be accepted, its work must be technically impeccable. Technically slipshod work will quickly lose the institution its most precious attributes: integrity and technical credibility.<sup>48</sup>

The fact that its position with respect to disputes is limited only to aspects of measurement and the discovery of scientific truth does not, however, mean that the institution is powerless. Quite the contrary. The mere fact that it is custodian of the national standards and is a potential arbiter in disputes gives it *ab initio* enormous power. Its pronouncements and publications carry great weight and are scrutinized carefully and thoroughly. Again this puts great pressure on the institution to ensure the technical accuracy of its work, but some publications can nevertheless cause considerable consternation. There are various examples of this, from national safety codes

---

<sup>47</sup> An obverse and undesirable consequence of permissiveness is that it can lead to performance of unimportant and irrelevant work. For the Bureau, this is mitigated, if not precluded, by a number of oversight mechanisms. The Organic Act established a visiting committee that visits the Bureau at least yearly and reports to the secretary "upon the efficiency of its scientific work and the condition of its equipment." Further and continuing oversight is provided by the secretary, by the Congress, by other agencies for which the Bureau performs work on transferred funds and, beginning in 1953, Advisory Committees reporting to the Bureau director on each of the Bureau's major organizational units. And the wisdom of Bureau management cannot be discounted.

<sup>48</sup> Perhaps the best examples of the Bureau's work in this arena are provided by the analysis of the causes of failure of structures.



Although NBS had no regulatory duties or power to initiate investigations, if called upon it could serve as an impartial arbiter. Here, Charles H. Oakley lowers a 10 000 lb weight onto a railway-scale test-car in order to test the Union Pacific scale. In 1913, at the request of the Interstate Commerce Commission, NBS began testing railway scales. These scales were the source of continual complaints, and the railways, fearing for their reputations, were eager to rectify the situation.



proposed early in the Bureau's history<sup>49</sup> to the most famous case of all, the battery additive controversy.

Given a permissive law, and the absence of regulatory responsibility, it was predictable that the work of the Bureau should lead it to become—or at least look upon itself as—the principal agency in the Federal Government for basic research in the physical sciences. But, in the absence of any regulatory responsibility, the Bureau might well have become what it did even without the permissive phrases. Once the Bureau became a laboratory doing research on improving the measurement methods on which new and more accurate standards are based, it is at least an arguable proposition that the growth and metamorphosis it underwent would have happened. All science, engineering, and industry are based on measurements whose accuracy is based on standards. Machine parts made in Cleveland must fit machines made in Detroit; a kilowatt-hour in Arkansas must be the same as one in Florida; a gallon of gasoline in California must have the same volume as one in Connecticut; the frequency of a radio station—not yet a consideration in 1901—must be accurately known lest it interfere with neighboring stations; a joule of energy in a cyclotron beam at Berkeley must be the same joule delivered by an electric generator in New Jersey, and both must have a constant and well-known relation to a calorie produced in a reaction in a research laboratory in Delaware; and on and on, throughout all of industry, commerce, and science. For, in the oft-quoted but always pertinent words of Lord Kelvin:

I often say that when you can measure what you are speaking about and express it in numbers you know something about it; but when you cannot measure it, when you cannot express it in numbers, your knowledge is of a meager and unsatisfactory kind: it may be the beginning of knowledge, but you have scarcely, in your thoughts, advanced to the stage of science, whatever the matter may be.<sup>50</sup>

Thus, with this all-pervasive position of measurements in the scientific, commercial, and industrial life of the Nation, the institution whose principal purpose was to ensure the uniformity and accuracy of those measurements had to become conversant and expert, at the level of basic national standards, with all the measurements made in the country. And it had to provide measurement methods and the standards on which they are based so that all elements of the Nation might speak the same language. Equally important, it had to provide a system which would ensure that all the measurements made in the Nation were in accordance with—"traceable to," in the language of the

---

<sup>49</sup> MFP, 121. Presumably using its authority to work on "the solution of problems which arise in connection with standards" (Organic Act, Sec. 2), and that provided by special appropriations from Congress, in the early years of the century the Bureau became concerned with several safety problems. Among them were those associated with the generation, transmission and use of electricity. In 1914 it proposed a national electrical safety code. This met with strong resistance from public utilities for a number of years. However, faced with confusing regulations by state public utilities commissions, the utilities came to welcome the Bureau's scientific and rational approach. Note that the Bureau had no authority to impose the code.

<sup>50</sup> William Thomson Kelvin, 1st Baron, *Popular Lectures and Addresses*, v. 1, *Constitution of Matter*, 2nd ed., (London: Macmillan, 1891): 80-143. "A Lecture delivered at the Institution of Civil Engineers on May 3, 1883; being one of a series of Six Lectures on 'The Practical Applications of Electricity.' "

trade—the national standards in its custody. The ubiquity of measurements and their increasing diversity in a technologically expanding economy made growth and metamorphosis inevitable. It is only natural that in the process of carrying out its central measurement mission, the Bureau developed technical and organizational capabilities that could be turned to the solution of other technical problems of the Government or of the Nation in general.<sup>51</sup> In due course this was to lead the Bureau into a whole class of work that was not an inevitable consequence of its basic mission, but was an outgrowth of the mission having been defined broadly, and the institution being permitted to use its initiative to develop appropriate responses to these problems. The actual type of work carried out would change constantly as national goals and problems changed, and this work would envelop the basic mission in an ever-changing frame.<sup>52</sup> In carrying out work in this “dynamic periphery,” new knowledge would be obtained that fed back into the work and the capabilities of the basic mission, and conversely, so that the two types of work led to a dynamic symbiosis that greatly strengthened the institution, and brought its relations with industry and the rest of government into closer—but not always frictionless—contact.

The first example of this dynamic periphery was the testing of Government purchases.<sup>53</sup> The Federal Government is a large purchaser of supplies of enormous variety for its own use. The Bureau, from its very early years, got involved in testing these purchases to ensure compliance with specifications, and indeed the preparation of those specifications. Beginning in 1904 with the testing of incandescent lamps, it progressed rapidly to other commodities until by World War I all of its divisions were involved.

This work brought the Bureau into direct contact with industry. Specifications could not be so tightly drawn that they could not be met, nor so loosely that they would be of little value in ensuring a useful item. Meetings and full-scale conferences involving all interested parties were held, and often new, non-existent, test methods had to be developed. As a result, this work expanded beyond simple testing to full-scale research programs in the commodity involved, and this was in part to spawn three new divisions: Metallurgy (from the testing of structural iron and steel),<sup>54</sup> Mineral Products (from cement testing), and Organic and Fibrous Materials (from paper, textiles, leather goods, etc.). The results of all this work was to be of great benefit to the industry

---

<sup>51</sup> For a large part of its history, the Bureau was the only physical science laboratory concerned with civilian problems in the Federal Government. It was perhaps inevitable that its help would be sought when scientific or technical problems arose in the Government, or that the Bureau would unilaterally undertake such problems.

<sup>52</sup> Robert D. Huntoon coined the apt term “dynamic periphery” for this work.

<sup>53</sup> For a full account of the origins of testing for government purchases see MFP, 124-133.

<sup>54</sup> Metallurgy also had its origins in the study of the cooling curves of metals to provide fixed points on the temperature scale. Since impurities affect freezing points and the temperature constancy of the melting equilibrium, work in this area led on the one hand to the preparation of very pure materials and on the other to the study of the melting behavior of alloys, i.e., phase diagrams.

involved and ultimately to the whole Nation. And because of this testing and specifications work, the Bureau was drawn into working closely with, and indeed becoming a leader in, the voluntary standards system of the United States.<sup>55</sup> Its staff held key positions in the societies that comprise that system, and the data presented by Bureau representatives to the working committees of experts of the societies were instrumental in helping develop the myriad specifications, test methods, design standards, recommended practices, and other publications that form the library of output of the voluntary standard system. In this manner, the Bureau contributed to industrial and commercial standards which are emulated throughout the world.

Even more important was the Bureau's work on solutions to national technical problems, exclusive of work during times of war. There arise from time to time problems, usually concerned with public safety, that the Government needs to investigate and do something about. A recent example is environmental pollution for which a whole new agency was formed and for which the Bureau has provided considerable assistance. Two early examples will illustrate the Bureau's role in these problems.

Very early in its history, the Bureau became involved in electrochemistry for two reasons. First, the international definition of the ampere was the amount of silver that was deposited in a given time by electrolysis, and the international definition of the volt was based on the voltage developed in a standard electrolytic cell. Research on both these areas was designed to make the measurements more reproducible and accurate, and this led the Bureau into research in electrochemistry. The talents developed in this work in the basic mission were to be turned to an unusual problem: underground corrosion caused by stray currents from street railways.<sup>56</sup> First begun in 1887, by 1917 there were over 40 000 miles of street railways.<sup>57</sup> Power was supplied to the street car by a trolley wire and, in theory, was to flow back to the generating plant through the rails. All conduction in these metallic items is electronic so that no problems of electrolysis arise. However, the street railway tracks are not the only metallic structures in the ground. Particularly in cities, there are gas and water mains, lead-sheathed electrical cables, and other metallic structures. In favorable conditions of soil conductivity, these items can provide a lower resistance path for the return current, so that it can flow from the tracks through the soil into the structure, through the structure, and then back into the rail when conditions of proximity and soil conductivity are again favorable. The problem here is that conduction through the soil is ionic, not electronic. When current flows out of a metallic structure by ionic conduction, metal ions flow

---

<sup>55</sup> A discussion of the various usages of the word "standard" is found in Donald R. Mackay, ed., *A Glossary of Standards-Related Terminology*, Natl. Inst. Stand. Technol. (U.S.) NISTIR 89-4194; October 1989: 7.

<sup>56</sup> MFP, 119-121.

<sup>57</sup> The system of street railways was very extensive, being inter-urban as well as intra-urban. E. L. Doctorow, in his well-known novel *Ragtime* (New York: Random House, 1974), gives a detailed account of a trip from New York to Boston by street railway at the turn of the century. The total cost was \$2.40.

out of the structure into the soil, removing metal from the structure and degrading it. Corrosion takes place.<sup>58</sup>

During excavations in Boston in 1902, badly corroded water mains were found, and similar conditions in other items were found elsewhere. Losses from this source of material degradation were estimated in millions of dollars, and considerations of public safety raised a cry of alarm. Taking the initiative, the Bureau asked for and received a three-year special appropriation to investigate the problem. Progress was slow in this very difficult area. While methods were rather quickly devised to pinpoint the places where this stray current corrosion was taking place, and possible solutions to the problem were devised, they were very expensive. It was not until almost two decades after the initiation of the investigation that the solution of using sacrificial anodes was devised. In this method, a piece of relatively active metal, such as zinc, is attached to the corroding structure. The active metal, rather than the structure, then conducts the current from the metal to the soil. The reactive anode is sacrificed to save the structure. By this time the Bureau's work had expanded to the corrosion of metals in the ground in the absence of stray currents, and the Bureau had formed a Corrosion Laboratory to study this national problem.

A second early example of the Bureau's work on national problems is provided by failures of railroad equipment.<sup>59</sup> Concerned about failures occurring in railroads, Congress in 1910 passed legislation requiring monthly reports of railroad accidents. Two years later, the Interstate Commerce Commission (ICC) reported the alarming results that there had been almost 13 000 deaths and injuries from collisions and derailments alone in the previous year, and for the years 1902 to 1912 there had been a total of 41 578 derailments caused by broken wheels, rails, flanges and axles.<sup>60</sup> At the urging of the secretary of commerce, the Bureau undertook to study this problem and received a special appropriation from Congress in 1912 for the work. Thus began a long study of railway materials in the newly-formed Metallurgy Division. Working with the steel companies, nothing less than a thorough analysis of the metallurgy of tracks and wheels, and the manufacturing processes by which they were made, had to be carried out. Even then progress was slow in coming. It was not until 1923, when the special appropriation ended and the Bureau carried out further work under its own appropriation, that progress began to be observed. By 1930, the accident rate from these two causes had fallen by two-thirds. Work on these rail and wheel problems dropped shortly thereafter, but started again in 1985 with funds provided by the Federal Railroad Administration of the Department of Transportation, which now has the responsibility of ensuring railway safety.

---

<sup>58</sup> In many cases, the current flow is localized at specific sites, leading to preferential metal removal from those sites and eventual puncture. This phenomenon is called "pitting corrosion."

<sup>59</sup> MFP, 118-119.

<sup>60</sup> As a comparison, for the years 1982 to 1987, there was a yearly average of 3538 accidents and 762 fatal and non-fatal injuries. These data are from the *Federal Railroad Administration Accident/Incident Bulletin*, No. 156, 1987.

This work on the dynamic periphery had an important, indeed almost crucial, role in determining the nature and character of the Bureau. In the early examples noted above, no other agencies were responsible for the problems in question, and the Bureau either acted unilaterally or at the suggestion of another agency (e.g., the ICC in the matter of railroad failures). It carried out the work under special appropriations from the Congress. During World War I, the Bureau was called upon to carry out a great deal of work for various agencies of the military.<sup>61</sup> Funds for part of this work came from special wartime appropriations from Congress, but part of them came from a wartime measure, the "Overman Act," passed on May 20, 1918.<sup>62</sup> This law authorized the transfer of funds from one agency to another for the performance of work which the first agency needed but did not have the necessary staff or facilities to carry it out. The Bureau had received more than \$500 000 from military agencies under this arrangement. By the end of the war, the Bureau's size had more than doubled, and it had a large number of uncompleted projects for the military. But with the end of the war, the "Overman Act" expired, and transfer of funds from the military was no longer authorized.<sup>63</sup> Indeed, to get \$100 000 transferred from the Quartermaster Corps to the Bureau, Stratton went directly to President Wilson. Reversing a course against transferred funds that he had previously set, Stratton, in his appropriation request for fiscal year 1921, suggested that the following passage be included in the appropriations bill:

[T]he head of any department or independent establishment of the Government having funds available for scientific investigations and requiring cooperative work by the Bureau of Standards . . . may, with the approval of the Secretary of Commerce, transfer to the Bureau of Standards such sums as may be necessary to carry out such investigations.<sup>64</sup>

This statement, or variants of it, was repeated in subsequent appropriations bills, and eventually became law. The Bureau had become a contract research organization within and for the Federal Government. The camel of "other agency" work, as it became known at the Bureau, had entered the tent and was never to leave.

If all that a national standards laboratory did were to keep its prototype standards in a vault and only worked on increasing the accuracy of realizing those standards, it would not be a very useful institution. It also must ensure that the measurements made in the Nation are consistent with, and traceable to, those national standards. The Organic Act recognizes this function in two clauses, "the comparison of standards used in scientific

<sup>61</sup> See MFP, Chapter 4 for a thorough account of the Bureau's work in World War I. Also see *War Work of the Bureau of Standards*, Natl. Bur. Stand. (U.S.) Miscellaneous Publication 46; April 1921.

<sup>62</sup> MFP, 213; *An Act Authorizing the President to coordinate or consolidate executive bureaus, agencies, and offices, and for other purposes, in the interest of economy and the more efficient concentration of the Government*, U.S. Statutes at Large, 40 (1918): 556.

<sup>63</sup> Transfer of funds from one agency to another was practiced on a sort of unofficial basis before the Overman Act. Why the Bureau and the military did not simply continue to transfer funds is not known.

<sup>64</sup> MFP, 214; *An Act Making appropriations for the legislative, executive, and judicial expenses of the Government for the fiscal year ending June 30, 1921, and for other purposes*, U.S. Statutes at Large, 41 (1920): 683.

investigations, engineering, manufacturing, commerce and educational institutions with the standards adopted or recognized by the Government . . .” and “the testing and calibration of standard measuring apparatus.” In effect, these two statements direct the standards institution to set up a system by which the Nation may be maintained on a common and consistent measurement basis.<sup>65</sup>

Specifically recognized by these statements are direct calibration and testing, perhaps the most basic elements of the system: Clearly, the first step in ensuring that measurements are made in accord with the national standards is to compare to the standards the instruments by which the measurements are made. Thus the Bureau has always had a calibration service. Interested customers can send in instruments or components—sets of master weights, master gage blocks, thermometers, electrical meters and components of various kinds—and have them calibrated (or “verified,” in the words of 1902) against the national standards.<sup>66</sup>

The states, which have the responsibility for enforcing weights and measures under the state laws, are an important part of the measurement system. Throughout its history, the Bureau has issued—with some fanfare—sets of standards for mass, length, and capacity to the states, which have become the working legal standards for the Nation. It has also cooperated with the states more generally on other standards problems, such as ionizing radiation, and by such mechanisms as the National Conference on Weights and Measures and the National Conference of State Building Codes and Standards.

Calibration is not, however, the only means of maintaining the National Measurement System, and sometimes is not even feasible, as in the measurement of composition. Another means is to distribute objects, or materials, one or more of whose properties are certified by the Bureau. Called “standard samples,” they began to be sold by the Bureau in 1905 when it undertook to distribute and certify the composition of samples of various types of iron provided by the American Foundrymen’s Association.<sup>67</sup> In the ensuing year, at the request of the Association of American Steel Manufacturers, the Bureau began the preparation and certification of samples of seventeen types of steel, and thus was the Bureau’s standard samples program born.

In 1950, the Bureau had a whole catalogue of standard samples. Each of these samples had a property (e.g., composition) certified by the Bureau to have a specified value or to be within a specified range. The purchaser of such a standard sample could then use it to calibrate his measuring instruments or procedures. In a sense, the Bureau sent its standards to the purchaser, who then carried out the calibration procedure. By 1951 there were 502 standard samples. A full 98 of these were samples of steel certified for the concentration of up to ten elements, and a total of 172 were samples

---

<sup>65</sup> The system by which the Nation keeps itself on a consistent measurement basis has been a subject of considerable scholarly analysis by R. D. Huntoon who called it the “National Measurement System.”

<sup>66</sup> These instruments and components are not compared directly with the national standards, but against working standards which are essentially replicas of the national standards and are periodically compared to them. The national standards are too precious for routine use.

<sup>67</sup> MFP, 93.

of other materials also certified for composition. The largest category was for hydrocarbons and organic sulfur compounds, with 224 samples, each certified for purity. Produced with the help of the American Petroleum Institute, these were used for research in the petroleum industry and for developing mass spectrographic methods for the analysis of product streams in petroleum refineries. Other samples are interesting for the property certified: Five pure metals—aluminum, copper, lead, tin, and zinc—were certified for melting points, which range from 1083.2 °C (copper) to 231.90 °C (tin), and are clearly for the calibration of thermocouples and pyrometers. Eight oils were certified for viscosity, ranging from 0.02 poise to 460 poise. Thirty-three samples were certified for radioactivity, including radon standards, radium gamma-ray standards, cobalt gamma-ray standards, and twelve rock and ore samples certified for radium content. But perhaps the most fascinating is a set of ten enameled iron plaques [sic] of Standard Colors for Kitchen and Bathroom Accessories. The Nation's measurement system involved a lot more than mass, length, time, and volts.

If calibrations and standard samples can be thought of as the "hardware" of the measurement system, then publications and conferences can be thought of as the "software." Aside from its many research publications, which are often concerned with methods of measurement, from time to time the Bureau published unabashedly tutorial documents on measurements and standardization problems. Three published near 1950 illustrate the nature of these publications: Circular 470, *Precision Resistors and Their Measurement*, by James L. Thomas in 1948; Circular 476, *Measurement of Radioactivity*, by Leon F. Curtiss in 1949; and Circular 490, *The Geiger-Mueller Counter*, also by Curtiss in 1950. In character these publications ranged from introductory papers directed at new workers in a field to short monographs directed at advanced workers. This effort culminated in 1969 with the publication of the first of ten volumes entitled *Precision Measurement and Calibrations*. Published as NBS Special Publication 300, these ten volumes are a collection of previously published papers by Bureau staff members on measurement aspects of various topics, e.g., temperature, time and frequency, photometry and radiometry, and heat.

From time to time, conferences on particular topics are held at the Bureau. But there is one yearly conference that deserves special mention. Beginning in 1905, after two years of trying, the Bureau convened a conference of state weights and measures officials. The object of the conference was the discussion of both the technical and administrative problems in administering the weights and measures programs of the various states. Only six states attended the first conference, but the idea caught on. Called the National Conference on Weights and Measures, meetings have been held yearly since 1905, with the exception of war years and some depression years, so that the eightieth meeting took place in 1994. Each meeting has a published report. In 1950, 143 officials from 34 states, the District of Columbia, and Puerto Rico; 123 representatives of business and industry; and 24 persons from Federal agencies attended. These conferences, and others like them, such as the National Conference on State Building Codes and Standards, have done a great deal to ensure the uniformity of measurements—and of the administration and uniformity of weights and measures regulations—throughout the Nation.

The best way to transfer knowledge and skill from one person to another is for people to work together. Thus, since 1920 the Bureau has had a program by which, under specified conditions, technical, industrial, and commercial organizations can send a person or persons to work with a member of the Bureau staff, thus getting the benefit of the Bureau facilities and the knowledge of its staff. Such persons are called Research Associates. The conditions under which such an arrangement could be made were (and are) that the project be of value to both the supporting organization and the Federal Government, and the Nation at large. All results are published. By 1950, more than 175 organizations had supported Research Associates at the Bureau, and in that year, 13 groups supported 62 associates. Perhaps the best-known arrangement is with the American Dental Association, which has supported a group of Research Associates at the Bureau since 1924. These associates and their Bureau colleagues carry out the bulk of the Nation's research on dental materials. Other associates have worked on fuels, electron tubes, commercial adsorbents, electrodeposition, corn products, cement, concrete, standards for x-ray diffraction analysis, chinaware, porcelain enamel, and asphalt roofing.

The National Bureau of Standards in 1950, then, was a many-faceted, multi-functional institution. It was a respected scientific laboratory with a broad program of studies. It performed work for other agencies of the Government, and carried out research in support of its own basic mission. Most important, and the function from which its nature and character derived, it was custodian of the national standards. The institution that has this function is a unique institution, and this made the Bureau unique, both in function and character. Usually invisible, it was present when any physical measurement was made, and since measurements pervade a modern industrial society, so also did its presence. And having no regulatory power, it could not force itself upon the Nation, but it was nevertheless the final arbiter in measurement questions, at least in principle. To function effectively in this position its work had to be thorough, scholarly, and technically impeccable, and as an institution it had to be perceived to be honest, objective, and totally apolitical. And this was how it was almost universally regarded.

It functioned well in this basic measurement mission. The technical work needed to compare instruments with the basic standards, to increase the accuracy of realization of those standards, and to develop new standards for new or old quantities requires painstaking attention to detail, thorough scholarship, and study of all the factors that can affect the accuracy of the result. In its requirements of thoroughness and attention to detail, the work is as much scholarship as it is scientific research. It requires a persnickety mind. This philosophy of work rubs off onto the rest of the institution, so that it becomes objective, scholarly, and attentive to detail—just the qualities needed to function in the unique position it holds in the Nation. The character of the institution derives from its function.

Its relative position in the Federal Government had, however, changed in the forty-nine years of its history. No longer was it the only physical science laboratory in the Government, as it had been for a large part of its history. The National laboratories had been formed in the immediate postwar period. The military had formed its own laboratories, and would form more. But in one important aspect, the Bureau's position



had remained the same. These other Government laboratories had, and still have, specific—though often widening—missions, the National laboratories in atomic energy, and the military laboratories in the requirements of their specific branch of the military. These laboratories could not be expected to concern themselves with breaking train axles or rails. The Bureau, on the other hand, was quite different. While it had a very specific basic mission, the remainder of its enabling legislation was so broad that it could work in almost any area of science it could justify, and it was called upon to work on national problems as they arose. And it was allowed to perform work under contract for other agencies of the Government, so that in 1950 a full 57 percent of its work was carried out for other agencies. In a corporate analogy, the other laboratories of the Federal Government were, and are, divisional laboratories, doing research to foster their divisions (and hence, of course, the corporation). The Bureau, on the other hand, was (and is) the “corporate,” or “central,” laboratory, concerned with all of the problems of the corporation (Nation), and in the process carrying out contract research for the divisions (other agencies).

### THE TECHNICAL WORK

After all is said and done, after all questions of function, character, policy, size and resources are answered, the products of the Bureau that really matter to the Nation are the accomplishments of its laboratories—the technical work of its scientists, engineers, assistants, technicians, craftsmen, and administrative personnel. In this, of course, it is no different from any other high-quality research laboratory. Only its unique position makes it special.

What, then, did these 3100 people, working on their 68-odd acres in Washington and their 23 field stations, actually turn out? To give even a condensed accounting of what was done would mean reproducing the Annual Report for 1950, a clearly inappropriate course here. Rather than that, some examples will be given of the Bureau’s work, first in the relatively routine area of calibration, testing, and standard samples, and then some from its research work.<sup>68</sup>

The testing and calibration work is a direct outgrowth of the Bureau’s custody of the Nation’s basic physical standards, as has been described. While the development of methods of test and calibration can involve considerable research, once these methods are established, the actual testing and calibration can be made rather routine, although great care and skill are still required. This is fortunate, for the volume of work is great. Thus, in 1950, over 250 000 tests and calibrations were performed for other Government agencies and for the general public, and 19 000 standard samples were distributed. This included sample-testing of 9 million barrels of cement, and 4 million light bulbs purchased by the Government. The latter involved the actual life testing of 5000 bulbs, roughly one in 800. About 2300 raw sugar samples were assayed for the Customs Service to assist it in determining import duties.

---

<sup>68</sup> The description of the work in testing, calibration, and standard samples comes directly from the Annual Reports. The description of the research work is considerably expanded from what is found there.

Some interesting activities in this testing and calibration area were:

- Over 2000 radium preparations were tested, principally for Government and private hospitals and clinics where they were used for radiation therapy. All such preparations sold in the United States were tested and certified by the Bureau, since no commercial laboratory was equipped to do this work.
- Nearly 1100 radioactivity standard samples were sold. In 1941, the Surgeon General's office requested the Bureau to establish a program to protect the life and health of people working with radium. The Bureau began systematic measurements of the radon (a product of the radioactive decay of radium) content of the air in the areas where persons worked and, in 1950, 898 such determinations were made.
- Over 14 000 items of electrical apparatus were tested for manufacturers, electric utilities, public utilities commissions, universities, private testing laboratories, and Federal agencies.
- A total of 63 366 calibrations of measurement standards for such quantities as length, area, angle, mass, volume, and density were carried out.
- A total of 15 318 thermometers, including 3078 liquid-in-glass laboratory thermometers, 132 resistance thermometers, 289 thermocouples, and 11 819 clinical thermometers were tested or calibrated.
- Five pursuit cars, 18 motor truck speed governors, and 615 automotive spark plugs were tested for Government agencies.
- The Federal tax on beer in 1950 was \$800 million. The Bureau tested 266 beer meters, whose accuracy is essential for the correct computation of the tax. A beer meter measures the total volume of beer produced by a brewery.
- Road tests of tires were made in collaboration with the Post Office Department and the National Capital Parks Police. These showed a variation of almost two to one in the wear rate of tires made from different manufacturers.
- Electron tubes for various purposes were tested for other Government agencies.
- Instruments and devices of almost every conceivable type for radio were tested and calibrated.

The diversity in the items in this list, ranging from the esoteric to the mundane, illustrate the enormous variety of the Bureau's work. But despite the impressive numbers in this recitation, these tests, calibrations, and standard samples do not represent the main output of the Bureau. Most of its work was research, both in its own mission and in work for other agencies of the Government. The bulk of this work was reported in the open scientific literature, although many reports—often classified—were prepared for the sponsoring agencies, which in 1950 were mainly military agencies and the Atomic Energy Commission. The development of devices like the magnetic clutch, and a currency counter developed for the Treasury Department, also formed part of the Bureau's output.<sup>69</sup> Thus, in the fiscal year ending on June 30, 1952, Bureau staff published 1500 papers and reports.<sup>70</sup> Of these, 1000 were reports,

<sup>69</sup> The magnetic clutch is described in the Annual Report, 1948: 24, and the currency counter in the Annual Report, 1950: 273.

<sup>70</sup> Annual Report, 1952.



This model auto bus, equipped with a magnetic fluid clutch and a magnetic fluid brake, was constructed at NBS to demonstrate the potential application of the magnetic fluid principle to automobile clutches. Jacob Rabinow, inventor of the clutch, operated the model.

classified and unclassified, most of them for other agencies of the Government. Approximately 300 papers were published in the open scientific literature, 115 in the Bureau's own *Journal of Research*, and the remainder in professional society journals. In addition, 118 summary reports were published in the Bureau's *Technical News Bulletin*, and monthly data that permitted the choice of the best frequencies for long-range radio communication were published in *Basic Radio Propagation Predictions*, another publication of the Bureau. Finally, there were forty-three longer papers published in the Bureau's nonperiodical series: six in the Applied Mathematics series; five in the Handbook series; sixteen in the Circular series; six in the Building Materials and Structures series, and five in the Miscellaneous Publications series.

Out of this wealth of output, six projects—chosen somewhat arbitrarily—offer examples of the Bureau's scientific work. All, along with many others, are found in the Annual Reports. While the treatment in three of the topics is somewhat

technical, the main intent is to describe the reasons for the Bureau's involvement in this work. This usually involves some history. In these technical topics, the lay reader may simply accept the scientific assertions made and, it is hoped, still follow the story. Footnotes are used both for explanation and for greater exposition for the technical reader.

### Length and Light: Natural Standards v. Artifacts

As long as the meter—the national standard of length—is the distance between two fine scribed lines on a beautifully made bar of platinum-iridium alloy, the only way for the whole Nation to be on a common length basis is to compare measuring instruments with this national standard. Calibration is, however, a time-consuming process for both the calibrating laboratory and the user of the calibration service. Moreover, calibration does not of itself ensure measurement accuracy. It is only one step in the measurement process. An error in any of the steps—something as mundane as having the laboratory at the wrong temperature during a calibration—can degrade measurement accuracy. The time spent in calibration could be more fruitfully spent in ensuring the integrity of the whole process.

It would be much better if the platinum-iridium meter bar (called an “artifact” in the trade) were replaced with a natural phenomenon or constant that could be used as a standard. Such a “natural standard” would be available to anyone—or at least anyone with the requisite scientific expertise—for calibration purposes. The central length artifact would become redundant, and the national standards laboratories would be relieved of the calibration business—something all would very much desire.<sup>71</sup> It is thus not surprising that quite early in the industrial revolution, natural standards as alternatives to artifacts for the measurement of length should have been sought. As early as 1827, Jacques Babinet suggested that “a wavelength of light would be an ideal unit of length.”<sup>72</sup> Then in 1892 Albert A. Michelson, of Michelson-Morley fame, compared the red line of cadmium with the international meter bar and obtained a value of 6438.4696 Å for the wavelength of the spectral line.<sup>73</sup> This was adopted in 1907 as the primary standard definition of the angstrom, and was checked several times in the subsequent half-century.<sup>74</sup> In 1889, Michelson and Edward W. Morley, in a paper entitled “On the Feasibility of Establishing a Light-Wave as the Ultimate Standard of Length,” wrote, “The brilliant green [mercury] line . . . in all probability this will be the

---

<sup>71</sup> In practice, of course, this would not happen, partly because most people would not have the requisite skill, and partly because calibration by the national standards laboratory is a desired certification. Note, however, that such certification is not an assurance of measurement accuracy. Accuracy in the calibration laboratory does not ensure proper use, and hence accuracy, in the field.

<sup>72</sup> W. F. Meggers, “What Use Is Spectroscopy?” *Applied Spectroscopy* 6(4) (1952): 4-10.

<sup>73</sup> The angstrom unit, denoted by the symbol Å, is 10<sup>-10</sup> meters.

<sup>74</sup> Meggers, “What Use Is Spectroscopy?” It is a remarkable fact that the wavelength of light—of the order of 600 billionths of a meter—can be measured more precisely than the distance between the scribes on the meter bar.

wave to be used as the ultimate standard of length.”<sup>75</sup> The prediction was premature. In 1892 Michelson discovered that “the green line of mercury is one of the most complex yet examined.”

No spectral line is perfectly sharp, i.e., consists of light of a single wavelength. All lines contain a distribution of wavelengths. The fewer these wavelengths—the “narrower” the line—the more it is suitable as a length standard. Now, a number of factors contribute to the width of the line. First, there is a natural width caused by inherent quantum mechanical characteristics of the line itself. Second is the temperature needed to excite the line. Third is the pressure, and fourth is the effects of electric and magnetic fields. But most important for the purpose here are so-called isotope shifts.<sup>76</sup> The same line from different isotopes of the same element are slightly different in wavelength. Natural mercury is a mixture of seven different isotopes with mass numbers 196, 198, 199, 200, 201, 202, and 204.<sup>77</sup> The brilliant green line that Michelson and Morley had proposed as the “ultimate standard of length” in fact consisted of seven very closely spaced lines. As a length standard, naturally occurring mercury was not very useful.

However, as suggested by Jacob H. Wiens and Luis W. Alvarez, the advent of nuclear reactors made it possible to prepare pure mercury-198 by transmutation of gold, and to use the wavelength of the light from it as a length standard.<sup>78</sup> Beginning in 1947, William F. Meggers and F. Oliver Westfall of the Bureau’s Electricity and Optics Division undertook to have this isotope prepared and to study its spectrum to see if in fact it could be the ultimate standard.

The preparation of the isotope is relatively easy. Gold, of atomic mass 197, when irradiated with neutrons gives the radioactive isotope gold-198, which, by emission of an electron, decays with a half life of 2.7 days to mercury-198. The mercury is easily recovered from the gold by distillation. Meggers and Westfall had gold irradiated in a nuclear reactor by the Atomic Energy Commission, and from this they recovered 60 mg of mercury-198 of 99.9 percent purity.<sup>79</sup> From this they made four lamps, each containing 5 mg of the mercury isotope and pure argon at a pressure of 5 mm Hg, and proceeded to study the spectral width of the green line, and other lines in the spectrum of mercury. All the experimental details that had to be worked out cannot be covered here. Suffice it to say that the items to be investigated were the type of lamp, the method of exciting the spectrum, the longevity of the lamp, and the myriad details of the measurement of the wavelength of the lines. This last was done relative

---

<sup>75</sup> A. A. Michelson and E. W. Morley, “On the Feasibility of Establishing a Light-Wave as the Ultimate Standard of Length,” *American Journal of Science*, 3rd series, 38(225) (1889): 183-186.

<sup>76</sup> Isotopes of an element are chemically identical but differ in their atomic mass.

<sup>77</sup> W. F. Meggers and F. O. Westfall, “Lamps and Wavelengths of Mercury 198,” *Journal of Research of the National Bureau of Standards* 44 (1950): 447-455.

<sup>78</sup> J. H. Wiens and L. W. Alvarez, “Spectroscopically Pure Mercury (198),” *Physical Review*, 58 (1940): 1005; J. H. Wiens, “Production of Hg<sup>198</sup> as a Possible Source of an Improved Wave-Length Standard,” *Physical Review* 70 (1946): 910-914.

<sup>79</sup> The mercury-198 used here was from the same batch as that used in the studies of the isotope effect in superconductivity.

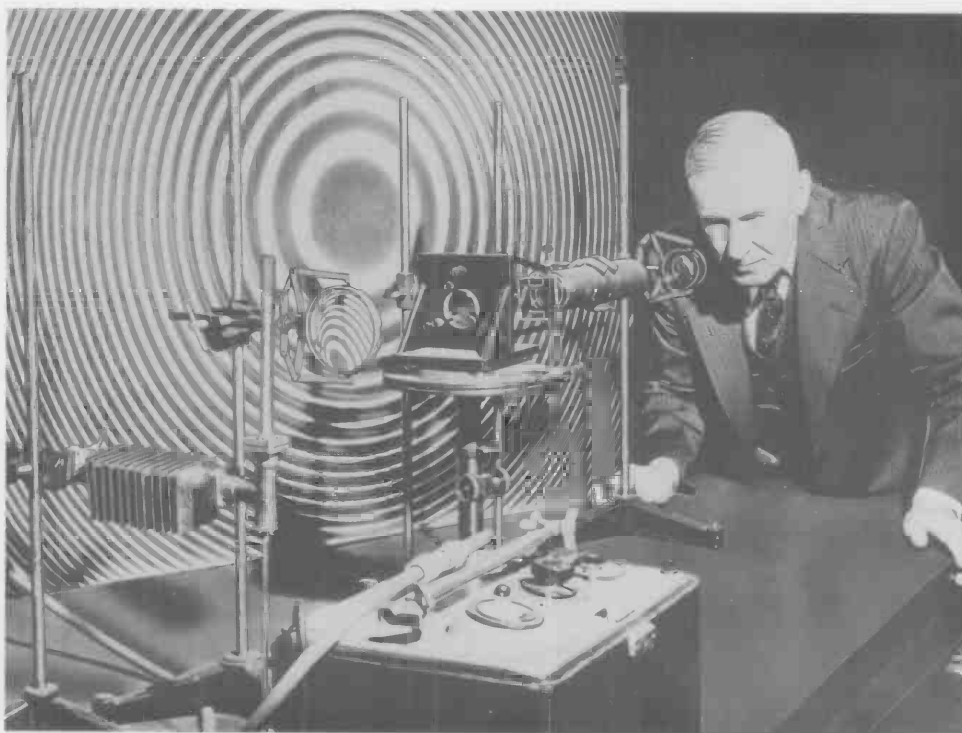

William F. Meggers peered through an electrodeless mercury-198 lamp which was made available to science and industry as an ultimate standard of length in 1951. Length measurements based on the circular interference fringes of green light from the lamp (background) could be made with an accuracy of one part in 100 million.

to the wavelength of the cadmium red line by interference techniques, since the cadmium line had been adopted by spectroscopists as a secondary standard of length, and as the definition of the angstrom. Indeed, the lack of sharpness of the latter is what determined the precision of the measurements. Nine mercury lines were measured, with the value of  $5460.7532 \text{ \AA}$  obtained for Michelson's "ultimate standard of length" green line. The accuracy obtained was one part in 100 million, and preliminary results obtained at the National Physical Laboratory in England and at the International Bureau of Weights and Measures (BIPM) in France were in agreement with the NBS results.

As frequently happens, this was not the last word. In due course an even more precise wavelength standard for length was to be adopted in 1960, and this replaced the old meter bar, which then became a historical relic. But the standard was not the green line of mercury-198. It was the even narrower orange-red line of krypton-86, with the meter being defined as the length of  $1\,650\,763.73$  wavelengths. However, the mercury-198 line has continued in use as a reliable and convenient working standard.

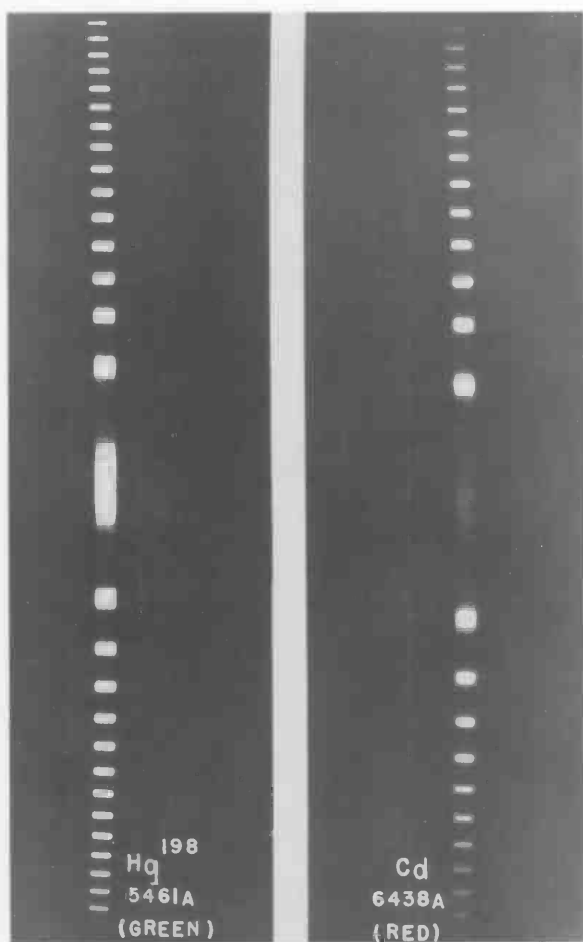

Relative sharpness of the mercury line compared to the cadmium line.

### Applied Mathematics and Computers

The previous example of the Bureau's work was concerned with its unique measurement mission. As previously discussed, this was only a part of the Bureau's work. In particular, in 1950, a full 57 percent of the Bureau's work was performed for other agencies of the Government. Work in computers and applied mathematics illustrates the nature of one of these other agency activities.

In 1950, the Bureau was no stranger to applied mathematics. Since 1938, it had been involved in the administration and sponsorship of the Mathematical Tables Project in New York. Begun as a Works Progress Administration project in 1938 to compute tables of mathematical functions, in 1943 the support of the project had been assumed by the Office of Scientific Research and Development. Subsequently, war problems

were undertaken by the Project. In the fall of 1946, OSRD support was withdrawn, but was replaced with support from what is now the Office of Naval Research. It had been a very successful project, 28 000 volumes of its tables having been sold to the general public between 1940 and 1946.

Partly because of this background, and in large measure because of his personal experience, when Edward U. Condon became director of the Bureau in 1945, he began to set up a program in applied mathematics, and hired John Hamilton Curtiss, then a lieutenant commander in the Navy, and previously professor of mathematics at Cornell University. Curtiss became an assistant to the director with special instructions to be concerned with the statistics of measurements. But developments conspired to give him and the Bureau much greater responsibility.

In 1945, computers were becoming a magic word. Everyone wanted one, but few could make them. Two who had proved themselves were J. Presper Eckert and John W. Mauchly of the University of Pennsylvania, who had produced the successful ENIAC (Electronic Numerical Integrator and Computer). Thus, when they approached the Bureau of the Census in 1946 with a proposal to build a computer for that agency to help with analysis of the 1950 census results, Census paid attention. The Census Bureau turned to the National Bureau of Standards for help and advice. In April 1946, the Census Bureau transferred funds to NBS, which was to select and purchase an appropriate computer. Early in 1947, the Bureau contracted with Eckert and Mauchly for the Census computer, now to be called UNIVAC (Universal Automatic Computer).

Soon the Bureau was swamped with computer money and obligations. The Army Ordnance Department transferred funds to the Bureau for research and development of computer components. Almost immediately, the Office of Naval Research (ONR)



John H. Curtiss, chief of the National Applied Mathematics Laboratories from 1946 to 1953, was responsible for the development of computers, statistical service to government and private industry, research aimed at extending the part played by applied mathematics in scientific research, and training scientists in the methods used in this field.



transferred funds to the Bureau for the procurement of a computer. In due course, the Bureau contracted for this computer with the Raytheon Company in early 1947. Meanwhile, early in 1946, Admiral Harold G. Bowen of ONR approached Condon with the idea that ONR and NBS jointly set up a laboratory that would be equipped with high-speed computing machinery, lead in the development of such machinery, and serve as a central computation facility. Finally, in 1947, two more UNIVAC's were ordered: one for the Air Comptroller and one for the Army Map Service.

A year of study on Admiral Bowen's proposal "revealed the need for a Federal center of applied mathematics. . . . Accordingly, the plans which finally emerged proposed that a facility with a mission considerably broader than that of a central computing laboratory should be established; further, that it should take the form of a new division of the National Bureau of Standards."<sup>80</sup> Following this advice and to organize all the new responsibilities the Bureau had acquired, Condon, in 1947, established the National Applied Mathematics Laboratories as Division 11 of the Bureau, and appointed Curtiss as its chief. The new NAML consisted of four units: The Institute for Numerical Analysis at UCLA, a Computation Laboratory which was to be a development of the old Work Projects Administration (WPA) project, a Statistical Engineering Laboratory, and a Machine Development Laboratory. The last three were located at the Washington site. Thus, partly because of the desires of its director and partly because of the needs of the Navy—and using primarily military money—the Bureau had a new activity.

By 1948, it became clear that none of the computers which had been ordered would be completed on schedule. In the meantime, the Bureau had made plans to build a small "interim" computer, partly because of the delay in delivery, and partly to gain experience in machine construction and design.<sup>81</sup> This activity was supported by the Air Comptroller, and was soon expanded to construct a full computer rather than an interim device.

The Bureau was in a good position to build a computer. During World War II it had gained great expertise in electronics and production of electronic components and devices.<sup>82</sup> Its work on the proximity fuze and in guided missiles had led it to specialize in miniaturization of components, and into the development of the printed circuit. It was therefore undaunted at the prospect of building a computer—it was simply another electronic device, albeit more complicated. Indeed, under the previously mentioned contract with the Ordnance Department, the Bureau was developing basic computer components: memory organs, input-output equipment, specialized electron tubes for gating, switching, signal delay, interval timing, and pulse shaping.<sup>83</sup>

Construction of the computer was begun in the fall of 1948 in the NBS Electronics Division by a group under Samuel N. Alexander, and with active collaboration by

<sup>80</sup> J. H. Curtiss, "A Federal Program in Applied Mathematics," *Science* 107 (1948): 259.

<sup>81</sup> Harry D. Huskey, "The SWAC, The National Bureau of Standards Western Automatic Computer" in *A History of Computing in the Twentieth Century*, ed. N. Metropolis, J. Howlett, and Gian-Carlo Rota (New York: Academic Press, 1980): 419-431.

<sup>82</sup> MFP, 451-462.

<sup>83</sup> "A History of NBS Computer Developments," *Technical News Bulletin* 51 (1967): 168-172, 181.

members of the Machine Development Laboratory. By modern standards the specifications for the computer were modest enough: 512 forty-four-bit words of mercury-delay-line memory (later expanded with 512 words of electrostatic memory), a cycle time of one megahertz, and input and output by teletype punched paper tape (later replaced with magnetic wire and tape)—but they were the state of the art. An item of note and a harbinger of the future is that all the logical operations of the computer were carried out by germanium diodes; vacuum tubes were used only for amplification. Thus it was the first computer to use solid-state electronics extensively. It was dedicated on June 20, 1950, just twenty months after construction had begun. It was first named Standards Electronic Automatic Computer, but later re-named as Standards Eastern Automatic Computer (SEAC). The change was occasioned by the building of a companion computer at the Institute for Numerical Analysis at UCLA and naming it the Standards Western Automatic Computer (SWAC), dedicated on August 17, 1950. The latter computer was quite different in logical design and construction, being a parallel machine in which all the digits of a number in memory are changed simultaneously, had electrostatic memory rather than mercury-delay-line memory, and also used a magnetic drum memory.

At the time SEAC was dedicated it was the only stored program machine in the United States, and the fastest such machine in the world. It was not, however, the first stored program machine internationally, having been preceded by the EDSAC at the



Among those who prepared SEAC for its pioneering role were Ralph J. Slutz, examining the paper tape punched with input data, and Samuel N. Alexander, examining the computer's printout.

University of Cambridge, a machine at the University of Manchester, and probably the ACE machine at Cambridge.<sup>84</sup> SEAC worked until April 1964, when it was retired, and its remains are at the Smithsonian Institution. From its initial operation it worked on numerous important problems. The first one was the tracing of skew rays through a compound lens. This was followed by many others: the solution of partial differential equations by Monte Carlo methods, the generation of optimum sampling plans for the Census Bureau, the calculation of transient stresses on aircraft structures, the development of accounting procedures for the Social Security Administration, problems in crystal structure and the relative abundance of the elements, the wave functions of atoms; and the designs of the synchrotron and of electric circuits. It was extensively used by the AEC for calculations on highly secret projects, believed by some of the Bureau staff to be associated with the hydrogen bomb. It was also used in what was probably the first automatically calculated Earth-Moon trajectory.

### The Isotope Effect in Superconductivity

Superconductivity is a fascinating property exhibited by some materials. Below a well-defined temperature, the material loses all electrical resistance, and an electric current induced in a superconducting loop can in principle continue to flow indefinitely. The temperature at which the normal state transitions to the superconducting state occurs depends on the magnetic field; a sufficiently strong magnetic field will prevent superconductivity at all temperatures. But perhaps most important for the Bureau's purposes, it occurs at very low, but well-specified, temperature—only a few degrees above absolute zero, at least for the superconductors known in 1950. The reason for this importance lies in the nature of standards for temperature scales.

Unlike standards such as those for mass, length, and electrical resistance, the unit of measurement of temperature—the degree, either Celsius, Fahrenheit, or kelvin—cannot be stored in a vault, to be removed periodically to standardize measuring instruments. What can be stored in a vault (but more likely in a laboratory rather than in a vault) is a device to measure temperature—a thermometer. But what establishes a temperature scale is not a thermometer, which does nothing but give an indication of some kind (e.g., the length of a fine column of liquid-in-glass capillary tube) when its temperature is changed. What establishes the scale is a series of “fixed points.” Thus on the Celsius scale (previously called the “centigrade” scale), the temperature of ice in equilibrium with air-saturated water at a pressure of one atmosphere (the fixed point called the “ice point”) is defined as zero degrees. And the temperature of boiling water, again at one atmosphere (the fixed point called the “steam point”), is defined as 100 degrees. The corresponding temperatures on the Fahrenheit scale are 32 and 212 degrees, respectively. Assigning temperatures to these two fixed points defines the size of the degree, and defines the temperature scale over this temperature range. Assigning other fixed points (usually boiling and melting points of pure substances) extends the scale beyond the ice and steam points, but no temperature can be lower than “absolute zero,”

---

<sup>84</sup> Ralph J. Slutz, “Memories of the Bureau of Standards’ SEAC” in *A History of Computing in the Twentieth Century*, ed. N. Metropolis, J. Howlett, and Gian-Carlo Rota (New York: Academic Press, 1980): 476.

which occurs at  $-273.15\text{ }^{\circ}\text{C}$  on the Celsius scale—a value established with the gas thermometer, a precise first-principle instrument used in laboratories specializing in temperature measurement.<sup>85</sup> But in any case, fixed points are natural phenomena and hence accessible to anyone with adequate equipment. Because of this accessibility they are in a sense superior as standards to stored artifacts. Anyone can use them to calibrate any kind of thermometer.

Ever since Kamerlingh Onnes at the University of Leiden discovered in 1908 how to liquify helium, physics at very low temperatures became an active and fascinating field of research. Helium itself showed a very interesting and totally unexpected property. At a temperature of 2.18 K, 2.03 K below its boiling point, it showed a dramatic drop in its viscosity as the temperature was lowered.<sup>86</sup> It became a “superfluid” and apparently remained so down to absolute zero. Equally striking, Onnes discovered in 1911 that mercury, at a temperature of 4.15 K, lost all electrical resistance; it became a “superconductor.” By 1950, twenty pure metals and a large number of alloys were known to be superconductors.

Because of the intrinsic interest of their electrical properties, and because of their possible use as temperature fixed points at very low temperatures, it was natural that the Bureau should be interested in superconductors at a very early date. Thus it is not surprising that as early as 1918, Francis Silsbee, then an assistant physicist in the Electricity Division, should be concerned with superconductivity. He in fact enunciated what was to become known as the Silsbee effect.<sup>87</sup> It was known that currents higher

---

<sup>85</sup> The temperature scale defined by fixed points, and the thermometers used in various ranges of temperature is called the International Practical Temperature Scale. The thermodynamic, or kelvin, scale uses only one fixed point, the triple point of water (i.e., ice in equilibrium liquid water under its own vapor pressure). This temperature is, by definition, 273.16 K. Because of the temperature difference between the triple point of water and that of ice and water in equilibrium in one atmosphere of air, the temperature of the triple point of water on the Celsius scale is  $0.01\text{ }^{\circ}\text{C}$ . Absolute zero on the Celsius scale is  $-273.15\text{ }^{\circ}\text{C}$  and, of course, 0 K on the kelvin scale. However, the size of the degree on the kelvin scale (called simply a “kelvin”) is identical to that of the degree on the Celsius scale. The International Practical Temperature Scale, determined by a number of fixed points, is maintained in a periodically updated agreement with the kelvin scale.

In 1950, four fixed points besides the ice and steam points were defined by the International Bureau of Weights and Measures. These were the boiling point of oxygen at  $-182.970\text{ }^{\circ}\text{C}$ ; the boiling point of sulfur at  $444.600\text{ }^{\circ}\text{C}$ ; the freezing point of silver at  $960.8\text{ }^{\circ}\text{C}$ ; and the freezing point of gold at  $1063.0\text{ }^{\circ}\text{C}$ . Other fixed points are added periodically to define the scale further. Different thermometers are used in different temperature ranges.

<sup>86</sup> The temperature of the boiling point of helium was deduced from the platinum resistance thermometer. Below this point, temperatures were calculated from the vapor pressure of helium and its heat of vaporization using the Clausius-Clapeyron equation.

<sup>87</sup> Francis B. Silsbee, “Note on Electrical Conduction in Metals at Low Temperatures,” *Bulletin of the Bureau of Standards* 14(2) (1918): 301-306. The paper contains this perceptive passage at the end: “The theories thus far proposed to account for superconductivity . . . do not specifically indicate the existence of a critical magnetic field, and only the latter accounts for a threshold-current density. . . . If it is true . . . that the magnetic effect is the more fundamental, it would seem that this fact might afford a valuable clue leading toward a more satisfactory theory of the superconducting state. . . .” In 1918 the Bureau had no facilities for the production of liquid helium and hence no experimental program in superconductivity. Since Walther Meissner and R. Ochsenfeld discovered in 1933 that the behavior of superconductors in a magnetic field is indeed crucial in understanding the nature of the superconducting state, one is led to wonder what might have happened if the Bureau had had an experimental program in superconductivity.

than a critical value destroyed superconductivity. Silsbee hypothesized that the value of this critical current was such that the magnetic field it caused at the surface of the current-carrying superconductor was just enough to destroy the superconductivity. This conjecture was justified experimentally several times.<sup>88</sup>

Silsbee's conjecture was purely theoretical. Experimental work could not be done, for while the Bureau had had a program in low-temperature physics since 1904 when it purchased a hydrogen liquefier, it could not reach the temperatures of interest for superconductivity until 1948 when it purchased a helium liquefier.<sup>89</sup> Results came quickly. That the superconducting transition temperature might depend on the atomic mass, and hence the isotopic composition, had been conjectured several times, and attempts to measure this effect had been made with isotopes of lead.<sup>90</sup> No effect was found, probably because temperature control at the transition temperature of lead (7.26 K) is difficult. In 1950, with the development of atomic energy research, pure isotopes of several superconducting metals became available, so it became possible to look for the effect again.

Working with a 98 percent pure sample of mercury-198, and natural mercury with an average atomic weight of 200.6, Emanuel Maxwell of the Heat and Power Division's Low Temperature Physics Section found a difference of 0.021 K in the superconducting transition temperatures. The lighter isotope had the higher transition temperature.<sup>91</sup> At a transition temperature of approximately 4.15 K, a difference of 0.021 K is substantial. At the same time (both papers were received by the editor of the *Physical Review* on March 24, 1950), Charles A. Reynolds, Bernard Serin, Wilbur H. Wright, and Lloyd B. Nesbitt of Rutgers University announced similar results for four different isotopic compositions of mercury.<sup>92</sup> In a further analysis of their results, the Rutgers group announced that the transition was approximately proportional to the inverse square root of the isotopic mass.<sup>93</sup>

As these results were being obtained, and quite independently of them, Herbert Fröhlich, of the University of Liverpool, was developing a theory of superconductivity. While his paper was in proof, he learned of the experimental results and added a note pointing out that his theory predicted that the transition temperature should be

---

<sup>88</sup> Russell B. Scott, "Destruction of Superconductivity by Current," *Journal of Research of the National Bureau of Standards* 41 (1948): 581-588; and references therein.

<sup>89</sup> MFP, 466.

<sup>90</sup> E. Maxwell, "Superconductivity of the Isotopes of Tin," *Physical Review* 86 (1952): 235-242, gives references for these early attempts.

<sup>91</sup> E. Maxwell, "Isotope Effect in the Superconductivity of Mercury," *Physical Review* 78 (1950): 477.

<sup>92</sup> C. A. Reynolds, B. Serin, W. H. Wright, and L. B. Nesbitt, "Superconductivity of Isotopes of Mercury," *Physical Review* 78 (1950): 487.

<sup>93</sup> C. A. Reynolds, B. Serin, and L. B. Nesbitt, "Superconductivity of Isotopes of Mercury," *Physical Review* 78 (1950): 813-814.

inversely proportional to the square root of the isotopic mass.<sup>94</sup> Upon learning of the Fröhlich theory, both Maxwell and the Rutgers group carried out more extensive measurements. The Rutgers group, re-analyzing their previous data, which had some ambiguities, were first to show that the theoretical prediction was indeed correct.<sup>95</sup> Maxwell, working with isotopes of tin later, also confirmed the theoretical prediction.<sup>96</sup> A new scientific fact had been discovered. It is interesting to note that the work at both the Bureau and at Rutgers was supported by the Office of Naval Research.

In its early attempts to explain the effect, the Bureau felt that "the nucleus must have an important effect on the superconducting properties of the metal."<sup>97</sup> This is, of course, true, but is little more than a re-statement of the experimental results. Fröhlich, and in due course John Bardeen, Leon N. Cooper, and J. Robert Schrieffer, in their Nobel Prize theory of superconductivity, showed that the interaction of the electrons with the lattice vibrations is the crucial element in determining superconductivity. All else being equal (as in isotopes), the frequency of the lattice vibrations varies inversely with the square root of the isotopic mass, and this is the origin of the isotope effect. The use of superconductors to define temperature fixed points would have to be done with great care, and would involve using pure isotopes.

### The Charters of Freedom

For a country that reveres the documents on which it is based—the Declaration of Independence, the Constitution, and the Bill of Rights, aptly called the "Charters of Freedom" by the National Archives—the United States treated these documents rather cavalierly for about the first hundred years of their history. Indeed, Verner Clapp, former chief assistant librarian of the Library of Congress, wrote, "The Declaration of Independence is one of the most abused documents in the history of preservation of documents."<sup>98</sup> Other authorities somewhat more charitably blame the lack of knowledge of conservation science for the condition of the documents. The Bureau's activities in the preservation of the Charters is an excellent illustration of how its abilities could be turned to unusual problems, and of its role as the Nation's corporate laboratory.

---

<sup>94</sup> H. Fröhlich, "Theory of the Superconducting State. I. The Ground State at the Absolute Zero of Temperature," *Physical Review* 79 (1950): 845-856. This paper was received on May 16, 1950. There is an interesting sideline to this story. Fröhlich learned of the experimental results when he was spending some time at Purdue University lecturing on his theory. At the beginning of one of the sessions he excitedly announced the experimental results, and that they showed that there was an isotope effect, as his theory predicted. In the audience was Ralph P. Hudson, who was shortly thereafter to join the Bureau and eventually become chief of the Low Temperature Physics Section and the Heat and Power Division.

<sup>95</sup> B. Serin, C. A. Reynolds, and L. B. Nesbitt, "Mass Dependence of the Superconducting Transition Temperature of Mercury," *Physical Review* 80 (1950): 761.

<sup>96</sup> E. Maxwell, "Superconductivity of Sn<sup>124</sup>," *Physical Review* 79 (1950): 173.

<sup>97</sup> Annual Report, 1950: 33.

<sup>98</sup> V. Clapp, "The Declaration of Independence; A Case Study in Conservation," *Special Libraries* 62 (1971): 503.

Of the three documents (a total of seven sheets of parchment), the Declaration is in far worse shape than the others. The ink is now so faded that it is practically illegible. The signatures of the delegates to the Continental Congress are in particularly bad condition. The document suffered great tribulations. Following its engrossment,<sup>99</sup> signing of the parchment document took place on August 2, 1776, but not all the delegates signed at that time. During the Revolutionary War it followed the Continental Congress in all its moves. It was stored in a rolled-up configuration, being rolled from the top down. Periodically it was unrolled so that other delegates could sign it, and obliteration of the signatures presumably began.<sup>100</sup>

In July 1789, the Declaration and the other Charters were given into the custody of the Department of Foreign Affairs (renamed Department of State on September 15 of the same year), and they travelled from New York to Philadelphia, to Washington, thence to Leesburg for three weeks while the British occupied Washington in 1814, and finally back to Washington.

Most importantly, in 1820 Secretary of State John Quincy Adams, apparently concerned about the legibility of the Declaration, commissioned an engraving from William J. Stone. Stone transferred an image from the parchment document onto a copper plate by what was probably a wet process, which further degraded the image of the original. But he did make an engraving from which reproductions could be made, and all present copies of the Declaration come from that engraving. Perhaps Secretary Adams acted wisely, despite the fact that the process degraded the original. The copper plate is now at the National Archives.

The Patent Office was located administratively in the State Department and it had a nice, bright, white-painted room. In 1841 the Declaration was given to that office for display. It hung in the Patent Office for thirty-five years opposite a window and exposed to sunlight. Even in the absence of the body of knowledge about the preservation of documents then available, this action would appear to have been taken without a great deal of thought. The other documents were not on display, but were taken out of storage to show to important visitors.

In 1876, the Declaration was exhibited at the Centennial Exposition in Philadelphia, where its appearance elicited considerable concerned comment. This spurred Congress to appoint a commission "to have resort to such means as will most effectively restore the writing of the original manuscript . . . with the signatures appended thereto. . . ."<sup>101</sup> Nothing was done. In 1877, the Declaration was put on display in the new State, War, and Navy Building (now the Executive Office Building), but then in a room where smoking was permitted and in which there was a fireplace. Finally, following the recommendations of two committees of the National Academy of Sciences, all the Charters were carefully wrapped and stored in the dark in a steel case. Proper care of the documents was at last beginning to occur.

---

<sup>99</sup> To engross is to prepare the usually final handwritten or printed text of an official document. All of the "Charters of Freedom" were handwritten.

<sup>100</sup> Elizabeth Hawthorn Buck, "The Declaration as a Document," *Manuscripts* 10(3) (1958): 6.

<sup>101</sup> David C. Mearns, *The Declaration of Independence: The Story of a Parchment* (Library of Congress, 1950): 3.

In 1920, a third committee of preservation experts, formed this time by the secretary of state, wrote after examining the Declaration, "We see no reason why the original document should not be exhibited if the parchment be laid between two sheets of glass, hermetically sealed at the edges and exposed only to diffused light."<sup>102</sup>

Nothing was done in the State Department because on September 29, 1921, President Warren G. Harding ordered that all the documents save the Bill of Rights be transferred to the Library of Congress.<sup>103</sup> There the documents received great attention. A marble and bronze shrine was built for them on the west wall of the second-floor gallery where no direct sunlight could strike them. They were placed below two panes of glass between which there was an orange-yellow gelatin filter to further protect the documents from degradation by light. The documents were not, however, in hermetically sealed cases.

Not everything was perfect even in this regal setting. A report came that a visitor had seen a silverfish on one of the documents.<sup>104</sup> There were further reports that buffalo beetles were in the documents.<sup>105</sup> Moreover, the Library was not air-conditioned, so the documents were subjected to large changes in the relative humidity and, because of their location in the Library, to large changes in temperature. And science had shown that air pollutants could hasten degradation of documents, and in this setting the Charters were exposed to the ambient air. Thus, in 1940, Archibald McLeish, then Librarian of Congress, asked the National Bureau of Standards to look into the best method of displaying the documents.

The Bureau was a good place to look into this matter. Because of its work in commodity testing, it had been concerned with the durability of organic materials—paper, textiles, leather, fur skins—since early in the century. Two of its staff members—Bourdon W. Scribner and Arthur E. Kimberly—were authorities on paper, and authors of an extensive review on the preservation of records, paying special attention to the effect of sulphur dioxide as an air pollutant.<sup>106</sup> The Bureau quickly accepted McLeish's request and on March 16, 1940, Bureau Director Lyman J. Briggs sent to the Library a short report containing the following recommendations:

It is recommended that both documents be inclosed within sealed receptacles, and that the air within these receptacles be replaced with a chemically inert gas, such as nitrogen, helium, or argon, the gas to contain approximately 4 grains of moisture per cubic foot. . . . This would eliminate the danger of having excessive moisture in the documents at any time. Storing . . . in an inert gas will remove the possibility of deterioration from oxidation or from acid hydrolysis resulting from absorption of sulphur dioxide from the atmosphere.<sup>107</sup>

<sup>102</sup> *Ibid.*, 7-8.

<sup>103</sup> The Bill of Rights was transferred to the National Archives in 1938.

<sup>104</sup> Clapp, "The Declaration of Independence": 505.

<sup>105</sup> Interview with E. Carroll Creitz, July 29, 1987: 3. (NIST Oral History File)

<sup>106</sup> A. E. Kimberly and B. W. Scribner, *Summary Report of Bureau of Standards on Preservation of Records*, Natl. Bur. Stand. (U.S.) Miscellaneous Publication 154; March 1937.

<sup>107</sup> "Inspection of the Original Copies of the Declaration of Independence and the Constitution of the United States," report from Lyman J. Briggs to Martin A. Roberts, Assistant Librarian of Congress, March 16, 1940.



Nothing was done on this matter during the war years, except that the documents were moved to Fort Knox. The subject was re-opened in 1946, and the Bureau was asked by the Librarian of Congress to "take any steps necessary to insure the preservation of . . . the Constitution, the Bill of Rights, and the Declaration of Independence."<sup>108</sup>

As it had previously recommended, the Bureau decided to seal the documents in an inert atmosphere in glass cases, and a full-scale project was begun under the leadership of Gordon M. Kline, chief of the Plastics Section, and subsequently chief of the Division of Organic and Fibrous Materials.<sup>109</sup> There were a number of technical problems to be solved:



The Library of Congress delivered the Declaration of Independence and the Constitution of the United States to NBS.

<sup>108</sup> Letter, E. U. Condon to John D. Briggs, President of Libbey-Owens-Ford Glass Company, August 12, 1947. The reference to the Bill of Rights appears to be an error, for that document was in the custody of the National Archives, and the Bureau was not asked to encase it until May 9, 1952, by Robert H. Bahmer, Acting Archivist of the United States.

<sup>109</sup> *Preservation of the Declaration of Independence and the Constitution of the United States of America*, Natl. Bur. Stand. (U.S.) Circular 505; July 1951.

1. The production of the enclosure and the sealing of the documents in it.
2. The inert gas to be used.
3. Control of the relative humidity in the enclosure.
4. Detection of leaks.
5. Provision of protection from harmful radiation.

The first problem was easily solved. At that time, the Libbey-Owens-Ford Glass Company produced thermopane windows. These are essentially two parallel panes of glass with a hermetically sealed space between them. They were made by depositing a border of metal along the edge of a pane, soldering a dam of lead to this metal border, facing this dam with another pane with a deposited border, and then soldering that border to the lead dam. This gives a shallow box with glass front and back and lead sides. Placing the documents in the box prior to the final soldering step hermetically seals them in the box. Libbey-Owens-Ford was asked to participate in the project. They accepted, and in fact it was their craftsman, Louis Gilles, who constructed the glass enclosures and did the sealing of the documents in the cases.

The selection of the inert gas was simple. Helium was the obvious choice because of its very high thermal conductivity, which permitted leak detection by an ingenious means. Cells for measuring the thermal conductivity of gases had been in use at the Bureau for a long time as a method of gas analysis.<sup>110</sup> While such cells are now commercially available, in 1950 they were homemade. Essentially each cell is a helix of platinum wire through which a current is passed. The temperature, and therefore the electrical resistance, of the helix depends on the thermal conductivity of the surrounding atmosphere, and thus changes in its thermal conductivity are easily detected by measuring resistance. In the particular application for the Charters, four such cells were used. Two, outside the cases, were sealed in small copper tubes containing helium, and two, open to the ambient atmosphere, were sealed into the cases. These four sensors were then arranged in a bridge circuit so that a change in resistance of any one of them could easily be detected. Immediately after the final sealing of the cases, all cells were exposed to the same atmosphere of helium, and hence the bridge was in balance. If any air leaks into the cases, the thermal conductivity of the atmosphere inside the case drops and the bridge shows imbalance. The whole system was calibrated so that the amount of leakage could be determined. It was an ingenious way to detect leaks.

Moisture control of the atmosphere inside the enclosure is essential to prevent degradation. Too low a humidity leads to dehydration and embrittlement of the parchment document, and experiment and experience showed that humidity higher than 85 percent leads to a deterioration of parchment. High humidity also leads to the growth of micro-organisms. Experiments had shown that the ideal humidity was between 25 percent and 35 percent. The problem was how to stabilize the humidity, for without stabilization the humidity would rise as the temperature decreased, and fall as the temperature increased.

---

<sup>110</sup> Creitz, oral history: 9.



Copper tubing which led from a pure helium source was connected to the inlet tube of the test enclosure containing the Declaration of Independence in order to flush all air from the assembly. E. Carroll Creitz sealed the joint on the enclosure after the air had been completely removed.

Stabilization was accomplished by placing sheets of pure cellulose paper within the enclosure as a backing to the documents. Because of the great affinity of cellulose for water, this paper acts as a stabilizing reservoir of moisture, releasing moisture when the humidity decreases, and absorbing moisture when the humidity increases. The paper must be pure cellulose lest impurities in it cause its degradation with possible release of degradation products that could be injurious to the parchment documents. This paper was produced in the Bureau's own experimental paper mill.

The radiation filter required some research. Experiments showed that the most harmful rays were those in the wavelength range from 3100 Å to 4300 Å (i.e., from the blue-violet to the ultra-violet), although some radiation occurs even at longer wavelengths. Filters—sheets of yellow-orange colored acetate film—that absorbed the harmful wavelength range were obtained from the Eastman Kodak Corporation. Calculations showed that these sheets reduced the radiation damage by 90 percent and 98 percent respectively for incandescent lighting and filtered sunlight, while the viewing efficiency was reduced by only about 35 percent. Laminated glass with an interlayer of this material was produced for the project by the American Window Glass Company, and panes of this glass were positioned above the cases when they were finally placed in the shrine.

Having all the components ready, one final question remained to be answered. Could they all be assembled without damaging the documents—particularly from heat during the final critical soldering step? In June 1950, a trial sealing using a facsimile of the Declaration of Independence was carried out. Temperature measurements indicated that no damage would occur.<sup>111</sup> All indications were that the Charters of Freedom could be successfully encased.

During 1951, the five leaves of the Constitution and the single leaf of the Declaration of Independence were permanently sealed in their cases. The final steps were flushing with helium and final closure. Properly humidified helium was passed through the cases for several days, using fine copper inlet and outlet tubes specifically placed in the lead dam for this purpose. When the leak detectors showed that no air was left in the cases, “pinching off” the copper tubes and final sealing took place.

In August 1951, new, brighter lighting was installed at the shrine, using the same filters on the lamps as was used in the laminated glass filter in front of the document cases. And in September 1951, amid much ceremony, the Constitution and the Declaration were re-installed in the shrine at the Library of Congress. It seemed that the Charters had found a permanent home.

That was not to be the case. On April 30, 1952, the Congressional Joint Committee on the Library ordered the transfer of the Declaration and the Constitution from the Library to the National Archives.<sup>112</sup> Immediately, on May 9, 1952, the Archives asked the Bureau to encase the Bill of Rights.<sup>113</sup> The Bureau did so, and on December 15, 1952—Bill of Rights Day—all the Charters were transferred to the National Archives. The Charters had finally found a permanent home.

In 1988, records were found describing two leaks in the document cases.<sup>114</sup> When the encased documents were put on display at the Library, the cases of the Declaration and leaf no. 1 of the Constitution showed leaks. The Constitution case was repaired, but the evidence for the repair of the Declaration case is ambiguous. Finally, in July 1989, following tests by the Jet Propulsion Laboratory under contract to the National Archives, the status of the documents was reviewed by the Advisory Committee of the Archives. The documents appeared to be in the same condition as at the time of encasing.<sup>115</sup> There is at present no conclusive evidence that the Declaration case has a leak. Further, in the opinion of the assembled experts, a small leak would cause no problems, since in the present storage conditions a small admixture of oxygen would cause no discernible degradation. Filling the cases with helium was probably gilding the lily.

---

<sup>111</sup> This trial case is part of the NIST Museum collection and is displayed at the entrance to the NIST Library.

<sup>112</sup> *Congressional Record*, 82d Cong., 2d sess., 1 May 1952: D403.

<sup>113</sup> Letter from Robert H. Bahmer, Acting Archivist of the United States, to Allen V. Astin, May 9, 1952.

<sup>114</sup> Memorandum from Delmar W. McClellan, Acting Keeper of the Collection, to Dr. Frederick H. Wagman, Director, Administrative Department. Subject, “Shrine Documents, Status of.” October 29, 1952.

<sup>115</sup> Conversation with Leslie E. Smith, chief, Polymers Division, and member of the advisory committee for the Archives, August 1, 1989.

## Standards and Fundamental Constants

There are various quantities in nature that modern scientists consider to be fundamental constants. These quantities are believed to be the same for all observers, wherever they are in the universe, and appear not to change with time. Scientists believe that they have the same value now as they had at the origin of the universe. One example of a fundamental constant is the speed of light. Despite many attempts to demonstrate the opposite, this shows no temporal change. And it is a fundamental tenet of the theory of relativity that its value is the same for all observers, no matter what their relative motion. But most fundamental constants involve atomic and sub-atomic quantities. All properties of given atoms and their constituent parts are expected to be identical under the same conditions, wherever they are found. Thus the rest mass of a hydrogen atom, and that of its constituent proton and electron, are the same for all hydrogen atoms, and are believed to be the same now as they have ever been.<sup>116</sup> And this identity is not limited to mass. The magnetic moment and angular momentum of all protons are identical, and the same holds true for electrons. All atomic and sub-atomic particles are identical replicas of one another.

It is hardly surprising, therefore, that the measurement of fundamental constants should be of interest to standards laboratories. If a fundamental constant can be measured more accurately than can a standard, then there exists the possibility that the constant can be used to replace the standard.<sup>117</sup> Equally important, it can be used to confirm the value of a standard.

Specifically, the value of the international ampere, which was made the legal unit of electric current in 1894, was defined as “the unvarying current, which, when passed through a solution of nitrate of silver in water in accordance with standard specifications, deposits silver at the rate of one thousand one hundred and eighteen millionths of a gram [1118 micrograms] per second.”<sup>118</sup> The international coulomb—the unit of electric charge—was defined as the “quantity of electricity transferred by a current of 1 international ampere in 1 second.” These definitions are very closely related to—in fact, they derive from—the value of the fundamental constant known as the Faraday. This is defined as the charge carried by 1 gram mole of singly charged ions, or what is equivalent, the charge per 1 gram of singly charged ions of unit atomic weight. Indeed, from the legal definition of the ampere and coulomb, and the atomic weight of silver, one easily calculates the value of the Faraday as 95 621.9 coulomb/mole. Thus, a determination of the Faraday is equivalent to another determination of the standard for current or charge.

---

<sup>116</sup> Some modern theories (so-called “Grand Unified Theories”) predict that the proton may decay radioactively, but with a very long lifetime. Experiments have shown that this lifetime is greater than  $10^{32}$  years—about 10 billion trillion times the age of the universe.

<sup>117</sup> In 1983 the speed of light was used to replace the standard of length. The unit of length is no longer the distance between two scratches on a platinum-iridium bar, nor the length of 1 650 763.73 wavelengths of the orange red line of Kr<sup>86</sup> (itself a sort of fundamental constant). It is the distance light travels in 1/299 792 458 of a second in a vacuum.

<sup>118</sup> The 1894 law was superseded in 1950 when the absolute rather than the international ampere became the legal unit.

Prior to 1950, the determination of the Faraday constant had been carried out by electrochemical means.<sup>119</sup> In 1949, John A. Hipple, Helmut Sommer, and Harold A. Thomas of the Bureau's Atomic Physics Division devised a method for determining the Faraday by purely physical means.<sup>120</sup> The instrument they devised was modelled after a cyclotron, in which charged particles move in circular orbits whose plane is normal to an applied magnetic field. The frequency of their rotation is called the cyclotron frequency, and is given by the product of the charge to mass ratio of the particles and the magnetic field strength. Periodically they are given an accelerating pulse which increases their kinetic energy, hence the radius of their orbit. Hipple, Sommer, and Thomas did the same thing, but the acceleration was not by pulses but by a sinusoidal electric field. When the frequency of the electric field was the same as the cyclotron frequency, i.e., the two were in resonance, the ions could be made to impinge upon a collector. In this way, the cyclotron frequency could be measured, and measured precisely, for the resonance could be made very sharp. Then, knowing the strength of the magnetic field, the charge to mass ratio of the ions could be determined very accurately.<sup>121</sup> This number, multiplied by the isotopic mass of the ion, yields the Faraday. Since the instrument measured the cyclotron frequency, it was called the "omegatron" for the Greek letter used to denote angular frequency. It was a small device, about 5 cm × 2.5 cm × 4 cm.

After two years of experimentation, the group published its final result. The obtained value was  $96\,520 \pm 3$  coulombs/mole,<sup>122</sup> which agreed well with the value of  $96\,519.3 \pm 2.6$  coulombs/mole reported by D. Norman Craig of the Electricity Division and James I. Hoffman of the Chemistry Division for the electrochemical oxidation of sodium oxalate.<sup>123</sup> Both results were slightly, but not significantly, different from the definitive results of Craig, et al., of  $96\,516.5 \pm 2.4$  coulombs/mole in 1960. It was reassuring to be able to determine the value of the Faraday, which is basic to the definition of the ampere, without having to carry out electrochemical experiments.

<sup>119</sup> D. N. Craig, J. I. Hoffman, C. A. Law, and W. J. Hamer, "Determination of the Value of the Faraday With a Silver-Perchloric Acid Coulometer," *Journal of Research of the National Bureau of Standards* 64A (1960): 381-402. This paper illustrates the exquisite care that is taken in work relating standards and fundamental constants. See also D. N. Craig and J. I. Hoffman, "A New Method for Determining the Value of the Faraday," *Physical Review* 80 (1950): 487.

<sup>120</sup> J. A. Hipple, H. Sommer, and H. A. Thomas, "A Precise Method of Determining the Faraday by Magnetic Resonance," *Physical Review* 76 (1949): 1877.

<sup>121</sup> The magnetic field was determined by the proton precession frequency and known gyromagnetic ratio. Thus the only measurements made in the experiment were two frequencies.

<sup>122</sup> H. Sommer, H. A. Thomas, and J. A. Hipple, "The Measurement of  $e/M$  by Cyclotron Resonance," *Physical Review* 82 (1951): 697-702.

<sup>123</sup> D. N. Craig and J. I. Hoffman, "A New Method for Determining the Value of the Faraday," *Physical Review* 80 (1950): 487. The electrochemical determination of the Faraday was conducted in the Electricity Division because the national standard for the volt was maintained by the Electrochemistry Section in the Electricity Division. The direct reference to the national volt was essential to the determination of a physical constant, in this case, the Faraday.

## The Bureau and X Rays: High Energies Come to the Bureau

This is the story of how the Bureau obtained its first high-energy accelerators and brought in nuclear and theoretical physics research. They came via the study of x-ray measurements.

In its appropriation request for Fiscal Year 1947, the Bureau asked for—and received—\$250 000 for the purchase of a betatron. Invented in 1940 by Donald W. Kerst at the University of Illinois and the General Electric Company, the betatron permitted the production of a very-high-energy electron beam—50 million volts for the instrument the Bureau requested—which could then be used for the production of very-high-energy x rays. And in its request for Fiscal Year 1948, the Bureau asked for, and again received, a further \$565 000 for the completion of the building that was to house the betatron, and for the purchase of another betatron, this one for energies up to 100 MeV.<sup>124</sup>

The Bureau's justification for these large requests (the appropriated funds for the Bureau in 1947 totalled \$1.12 million exclusive of the betatron request) consisted of three parts. The first concerned the use of x rays for diagnostic purposes and for radiation therapy. The energy, hence the penetrating power of x rays used for therapy, had increased enormously in the postwar period, and standards and measurement methods were essential in this high-energy region so that radiologists could accurately deliver an exact dosage to the organ being treated. The second part concerned the industrial use of x rays. Highly penetrating x rays were being used more and more extensively for radiography. Rays from these new high-energy machines could penetrate 30.48 cm (12 in) thick steel castings to examine them for minute cracks and other flaws. And in both of these areas, the efficiency and adequacy of shielding materials had to be known in order to protect the radiologists and technicians working with this new, high-energy radiation. The final justification was for basic research. In the words of the justification:

The equipment proposed presents a tool for research in a field that is relatively untouched. A very limited amount of work has been done by OSRD in the 10 to 20-million-volt range, the exact nature and volume of which is still secret. By this means it is possible to study nuclear transformations, the production of artificial radioactivity and radiation processes hitherto known only through a study of cosmic radiation.<sup>125</sup>

---

<sup>124</sup> The abbreviation MeV stands for "Million electron Volts." This is the energy acquired by an electron falling through a potential difference of 1 million volts.

<sup>125</sup> House Committee on Appropriations, Subcommittee of the Committee on Appropriations, *Department of Commerce Appropriation Bill for 1947: Hearings before the Subcommittee of the Committee on Appropriations*, 79th Cong., 2d sess., National Bureau of Standards, 18 February 1946: 960.

There is no question that the principal justification for the Bureau's request was the medical use of x rays. Indeed, Lauriston S. Taylor, then chief of the X-Ray Section, tells the following anecdote about appearing before the Senate Appropriations Committee. He was prepared to go through a full presentation, and part way through it he passed to the chairman of the committee a copy of *Radiology* which contained colored photographs of people who had been seriously "burned" by x rays. The chairman glanced at the illustrations, then thumbed through the journal, finally coming upon a radiograph of a somewhat gnarled hand. He held up the journal and asked, "Doctor, is this a case of arthritis?" Even after looking at the title of the illustrations, Taylor was not sure but said that he expected arthritis might look like that. The chairman continued, "My sister has the worst kind of arthritis you ever saw, she is in such misery. . . ." Thereupon the chairman passed the journal to the other members of the committee, and it seemed that every one of the members had some relative suffering from arthritis. Taylor was quite nervous by this time, for his allotted time for making his presentation was rapidly disappearing. Suddenly the chairman turned to Taylor and said, "Doctor, I think this is one of the finest programs we have listened to in many years. I am sure that our committee will endorse this and we will give you all the funds you asked for." And they did—for the building and equipment. Thus did the Bureau enter the age of high-energy machines.

The Bureau had been in x rays for a long time, having obtained its first x-ray generator in 1917, twenty-two years after Roentgen's discovery of x rays. By that time x rays had grown into a scientific discipline and an industry. With the development of the Coolidge tube in 1913, the production of x rays had become routine and reliable. And the dangers of exposure to ionizing radiation, either from radium or x rays, were recognized before World War I. But the war tragically dramatized these dangers, for the Coolidge tube made x rays common during the War and "literally hundreds of doctors and technicians were severely injured or died as a result of their exposures."<sup>126</sup> It was clear that better ways of measuring and controlling the intensity of radiation were imperative.

The methods used for the measurement of radiation in 1920 were largely empirical, based upon the ionization of air, the darkening of strips of photographic film, color pastilles, selenium cells, and chemical coloration. A measurement method based on more fundamental concepts was needed. This and the concern for the protection of people from radiation led to the convening of the first International Congress of Radiology in London in 1925. Despite the fact that in the early 1920s the Bureau had been under considerable public pressure to begin an x-ray program, it sent no representative to this congress. However, when the Radiological Society of North America formed a Standardization Committee in 1925, Franklin L. Hunt, of the Atomic Physics, Radium, and X-Ray Section, and Noah Ernest Dorsey became

---

<sup>126</sup> L. S. Taylor, *X-Ray Measurements and Protection, 1913-1964: The Role of the National Bureau of Standards and the National Radiological Organizations*, Natl. Bur. Stand. (U.S.) Special Publication 625; December 1981: 3.



members of that committee.<sup>127</sup> Meeting in 1926, the committee concluded that the principal problems were the establishment of a standard x-ray unit, the variation in x-ray dosage as measured in this unit for different qualities of radiant energy, the devising of a system to transfer this unit "from a standardizing center . . . (preferably the United States Bureau of Standards) to different . . . institutions or private laboratories,"<sup>128</sup> and the further study of the proposed physical x-ray unit in relation to its biological effect. Promises of cooperation between the Bureau and the Society were made.

But it was not until 1927, with the arrival of Lauriston S. Taylor, a young physicist from Cornell, that the Bureau's program in x-ray measurements began.<sup>129</sup> The equipment he found was an old World War I diagnostic machine and totally unsuited for the task at hand. This was hauled away and replaced with other equipment designed and built by hand, and the program began to flourish under Taylor's vigorous leadership.

The principal task was the development of a national standard for the measurement of x-radiation. In 1928, the Second International Congress of Radiology, meeting in Stockholm, had adopted the definition of the roentgen as the unit of measurement of ionizing radiation as "the quantity of X-radiation which . . . produced in one cubic centimeter of atmospheric air at 0 °C and 76 cm mercury pressure, such a degree of conductivity that one electrostatic unit of charge is measured at saturation current."<sup>130</sup> A unit had been defined. The problem was now the realization of that unit.

By 1929 Taylor had developed a free-air ionization chamber which would realize the unit and which could eventually become the national standard for the measurement of ionizing radiation.<sup>131</sup> By 1932 he had intercompared the American standard with those of England, Germany, and France. In order to do this he had to develop a portable free-air ionization chamber and calibrate it against the primary standard, which was far too heavy to transport. This became known as the "guarded-field ionization chamber." He then travelled to Europe and made measurements at the foreign standards laboratories, which had developed new standards at about the same time

---

<sup>127</sup> In 1913, N. E. Dorsey, then of the Electricity Division, began the Bureau's activities in the standardization of radium preparations. Like others in this field, he received burns to his fingers and hands from the handling of these preparations. He resigned from the Bureau in 1920, becoming an independent consultant, and his hands healed. He re-joined the Bureau in 1928 and retired in 1943. (MFP, 147.)

<sup>128</sup> Taylor, *X-Ray Measurements and Protection, 1913-1964*: 10.

<sup>129</sup> It was in some ways an inauspicious beginning. Taylor had come to the Bureau to work with Hunt, only to find that Hunt would shortly leave to take a position at Western Electric. In addition, Paul D. Foote, chief of the section, was also in the process of leaving. To cap matters, Taylor had expected to work on x-ray spectroscopy, but instead was being asked to work on x-ray dosimetry. Somewhat embarrassed, Taylor went to see Clarence A. Skinner, the division chief, whom he told he would try it for a year. He stayed for thirty-seven.

<sup>130</sup> Taylor, *X-Ray Measurements and Protection, 1913-1964*: 281, 288. Note that this definition combines a definition of a quantity and the method of measurement. The definition was changed in 1937 to read, "The roentgen shall be the quantity of X- or gamma-radiation such that the associated corpuscular emission per 0.001293 grams of air produces, in air, ions carrying 1 e.s.u. of quantity of electricity of either sign."

<sup>131</sup> L. S. Taylor, "The Precise Measurement of X-Ray Dosage," *Bureau of Standards Journal of Research* 2 (1929): 771-785.

as the Bureau. The final agreement among the U.S., British, and German standards was  $\pm 0.5$  percent. (The French used a different unit.) The United States finally had a national standard for x rays, with a known relationship to comparable standards in other countries.

By the beginning of World War II, the Bureau program was flourishing. During the 1930s it had continued its studies of x-ray protection, along with research on measurement methods, and issued a number of handbooks explaining various aspects of radiation protection and measurements. These supplemented the 1929 Circular 374, *X-Ray and Radium Protection: Recommendations of the International Congress of Radiology*, and several research papers. It had made notable contributions to equipment for the generation of x rays, and its x-ray production capabilities had regularly expanded, with a 600 kilovolt x-ray generator built in 1934, and a 1.4 million-volt generator in 1940. It had done innumerable calibrations, and was recognized throughout the world as a leader in x-ray measurements.

The war caused a hiatus in this work. Many of the staff working on x rays and radioactivity went into war work. Taylor himself spent the war years working on the proximity fuze for bombs and rockets until 1943, and then organized operations research sections for the Eighth Fighter Command and the Ninth Air Force in Europe. Returning to the Bureau soon after the end of the war, he and the director, Lyman J. Briggs, made plans to expand the radiation programs, and to obtain the 50 MeV and 100 MeV betatrons later requested from the Congress in 1947 and 1948. Briggs retired in October 1945 and was replaced by Edward Uhler Condon, himself a theoretical physicist. Condon strongly supported the program, and it flourished. By 1950, the organizational unit that contained the work was called the Radiation Physics Laboratory and consisted of six sections. The work was described in six categories: Protection and Shielding Research (experimental and theoretical); Radiation Protection Recommendations and Codes; X-Ray, Gamma Ray and Radioisotope Standards; Measurements and Instruments; Theoretical Studies; General Atomic and Nuclear Physics Research; and X-Ray Equipment Research and Development.<sup>132</sup>

In 1950, the first of the betatrons—the one for 50 MeV—was delivered and installed in its own new and separate building. As described earlier, its main justification was in the medical use of high-energy x rays, and a great deal of work—both experimental and theoretical—on x-ray protection by various materials was indeed carried out. “Bread and butter work,” Taylor called it.<sup>133</sup> But more and more the machine was used for research in nuclear physics, and when it was learned how to extract the electron beam from the 50 MeV betatron so that it could be used directly for nuclear studies, the machine was used exclusively for nuclear physics. A great deal of distinguished work on photonuclear reactions, largely supported by the AEC, was carried out. When the second betatron—which in the interim had been converted to a 180 MeV synchrotron—was installed, the Bureau had a full-fledged, high-energy laboratory and a program of research in nuclear physics. In due course, the Bureau would acquire a linear accelerator and a nuclear reactor. The little 50 MeV betatron had led the way.

<sup>132</sup> L. S. Taylor, *X-Ray Measurements and Protection, 1913-1964*: 307.

<sup>133</sup> *Ibid.*, 312.

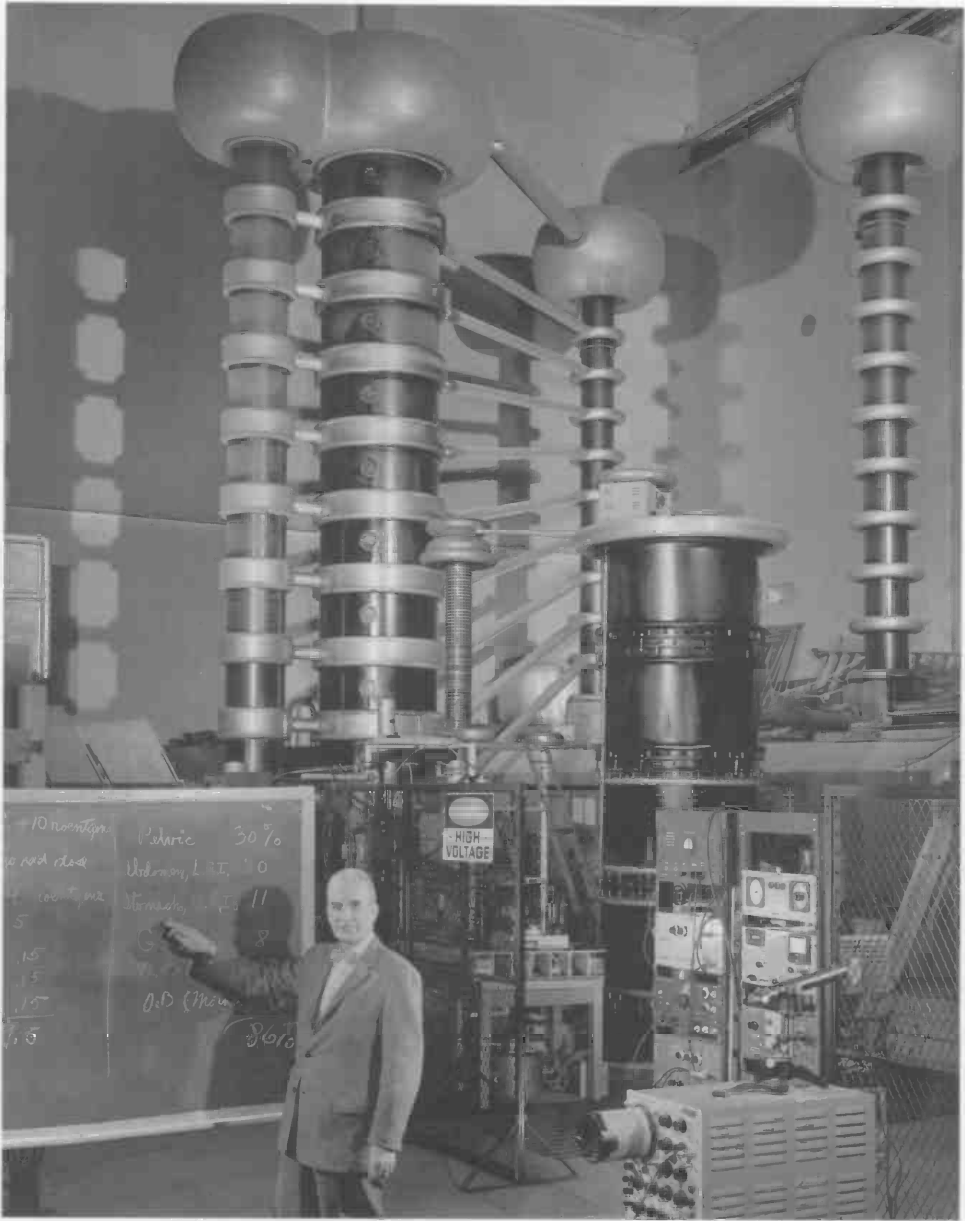

Lauriston S. Taylor, chief of the Atomic and Radiation Physics Division at NBS, pointed to x-ray protection standards on a chalk board with the 1.4 million volt x-ray generator and the neutron generator (black cylinder on right) behind him (1959).

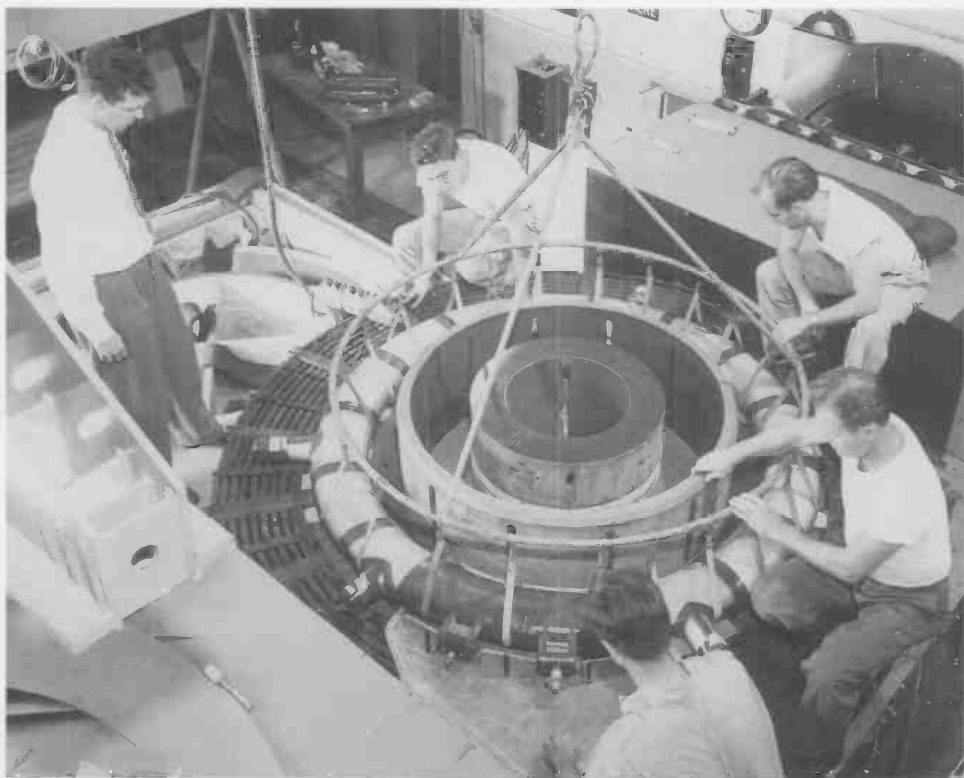

NBS staff installed the "donut" of the Bureau's new 180 million-electron-volt synchrotron. The synchrotron facilitated research in the physics of radiations and electrons in the energy range from 5 MeV to 180 MeV. The donut was an evacuated glass tube within which electrons were made to travel under the influence of magnetic and electric fields. The combined effects of the fields increased the electron energy by making the electron travel in a circular orbit at tremendous speeds. The heavy wires concentric to the "donut" augmented the magnetic field set up by the poles of a large magnet. The electric field was supplied by a high frequency generator and was injected into the electron path through the connectors in the wall of the tube.

In 1946, an event of great significance to the whole Bureau occurred. Like the rest of the Bureau, the work of the x-ray section had been purely experimental, with the sole exception of a young theoretical physicist from Cornell, Warren W. Nicholas, who was hired in 1928 but stayed only four years and was partly an experimentalist. But in 1946, a pure theoretical physicist, Ugo Fano, a former student of Enrico Fermi, was hired to work on x-ray problems, and did so brilliantly—on x rays and many other problems. As near as can be determined, this was the first time in its history that the Bureau had hired a pure theorist. He was not to be the last. For the Bureau, a new approach to the conduct of science had begun.



Ugo Fano, internationally known for his theoretical work in various branches of physics and in related sciences, had a profound influence on the field of atomic physics through his personal scientific creativity and his stimulation of many others at the Bureau. An important part of his work at NBS was consultation with experimental scientists on the theoretical aspects of their work. Fano showed a unique ability to explain the fundamental concepts of classical and modern physics in terms and analogies that scientists working in other fields such as biology and medicine could readily understand.

#### LIFE AT THE BUREAU

In an interview held on September 22, 1981, Allen V. Astin, who in August 1951 had succeeded Condon as director, was asked about life in the prewar Bureau.<sup>134</sup>

WEINSTEIN: Sir, can you tell us a little about what the working environment was like under Dr. Briggs?

ASTIN: Well, I thought it was excellent. It was the environment that made me satisfied to stay where I was. . . .

HUNTOON: If you were asked to characterize Briggs' environment, how would you characterize it. . . .

ASTIN: I'd say it was friendly, peaceful, cooperative.

HUNTOON: And free?

ASTIN: And free, very free.

HUNTOON: Freedom to do what you want to do?

ASTIN: Freedom to do what essentially you want to do.

HUNTOON: How much accounting?

ASTIN: Very little, very little accounting. It was an ideal atmosphere, I think, and I enjoyed it, and I'm sure my associates did as well.

<sup>134</sup> Interview with Allen V. Astin, September 22, 1981: 7-8. (NIST Oral History File)

In a similar vein, Jacob Rabinow, prolific and scholarly inventor, talks about his coming to work at the Bureau in 1938: "It was . . . a job where people behaved as ladies and gentlemen. . . . I never worked in a place as genteel and polite as the Bureau of Standards in Washington."<sup>135</sup>

While Astin's and Rabinow's comments pertain to the prewar Bureau, all indications are that this friendliness, this gentility and cooperativeness, this freedom in choice of work, characterized the postwar Bureau as well. These characteristics were part of the nature and traditions of the institution. Indeed, freedom in the postwar Bureau had returned to the freedom of access of the prewar years. Traditionally, the Bureau grounds are open to all comers during normal working hours, with no need to stop at a guard gate or other impediment. In fact, it was not until 1942 that the Bureau grounds were fenced. During the war, however, because of all the military work being carried out, entrance at all times was controlled by uniformed guards. Even Van Ness Street, the public thoroughfare through the Bureau grounds, was closed off.<sup>136</sup> Immediately upon the war's end, access returned to its traditional freedom, except for some restricted areas where classified work was being carried out.

Indeed, in one characteristic, freedom had actually increased. In the prewar Bureau, and during the war years, hours of work were rigidly controlled. One had to be at work by 8:30 a.m. or lose a half-hour of annual leave.<sup>137</sup> Now, under Condon, who believed that creativity could not be channeled into a strict regime and permitted scientific staff the freedom to set their own work schedule (provided that the stipulated number of hours were worked in a week), even working hours were set more freely.

More important than these rather mundane freedoms was the latitude in planning what work was to be done. At the upper levels of management, this question was decided rather simply: it was decided by the director in individual consultation with his division chiefs after consultation with associate directors, whose number varied from time to time, but was three in 1950. Their function was a mixture of staff and line, consulting with both the director and the division chiefs on program definition. The director set policy, and in individual consultation with the division chiefs set the program for individual divisions. In this program definition the division chiefs were given considerable latitude. They were, after all, generally Bureau people of long experience who knew well the mission, goals, and responsibilities of the institution. They were also highly competent technically, often world-renowned experts in their fields. They could be trusted to make sound decisions about what lines of work would carry out the institutional responsibilities, goals, and policies of the Bureau. And they had complete freedom to accept other-agency projects.

---

<sup>135</sup> Recollections of Jacob Rabinow, taped at his home on August 12, 1982. (NIST Oral History File)

<sup>136</sup> MFP, 372.

<sup>137</sup> *Ibid.*, 4.



Van Ness Street, N.W., a public thoroughfare through the Bureau grounds, was closed in 1942 by order of the secretary of war. (Copyright Washington Post; reprinted by permission of District of Columbia Public Library.)

At the section chief and scientist level, choice was quite a different matter. While the Bureau scientist was well aware of institutional responsibilities,<sup>138</sup> his goals were generally to follow scientific opportunities, and the section chief had much the same goals. The problem here was to follow the scientific opportunity while at the same time to carry out the policies of the director and the responsibilities of the institution. The amount of freedom section chiefs and individual scientists were given in resolving this problem varied with their immediate superiors and their own capabilities, but the tradition of the Bureau was to give as much as possible. Typically, an established scientist was encouraged to work on problems of his or her own choosing half the time, with the other half dedicated to problems specifically identified by the institution, although even in this, he or she was given wide latitude in how to accomplish the specified ends. Cases are known, however, of section chiefs who closely guided all the activities of the scientists beneath them; and other cases where scientists were given complete freedom, knowing, however, that their work would be in a specified field of importance to the Bureau and its mission.

The counterpart of freedom is cooperativeness. Cooperation among scientists was encouraged, and it was a tradition of the institution that advice and consultation would

<sup>138</sup> To a new employee, one of the most striking aspects of informal gatherings of Bureau scientists is their degree of introspection. Almost endless discussions take place on the Bureau's mission and policies, and on what it should do with respect to various national and technical problems.

be freely given. Part of this ease of cooperation arose from the manner of accounting for costs. In essence, until 1951, there was no way of accounting for the costs of individual work projects. A division had funds to work in a given area, and all the work except other-agency work was charged to that area. Thus, without the necessity for detailed accounting, cooperation was easy. In 1951, largely in response to Congressional criticism about the Bureau's lax administrative methods, a project accounting system was put into operation, and individual scientists had to account for their time on various projects.<sup>139</sup> In 1951 there were 630 unclassified projects.<sup>140</sup> This permitted much tighter control of scientist's time allocation and, depending on the division and section chiefs, impediments to cooperation could be raised. When bringing up the possibility of cooperation with another scientist, there was always the possibility of the dreaded question, "What project do I charge it to?" This did not halt cooperative research, for the tradition was too strong, but there was an impediment.

Unimpaired freedom of choice does not necessarily lead to good, creative work. Indeed, it can lead to continuation of old work in which the investigator feels comfortable and for which there is a ready, well-known audience, however small. Something of this kind had happened in the prewar Bureau. Robert D. Huntoon recounts an experience when he was a graduate student in physics at the University of Iowa.<sup>141</sup> His professor was Alexander Ellett, who was later to be in charge of the nonrotating projectiles proximity-fuze program for the Office of Scientific Research and Development (OSRD), with an office at the Bureau. Huntoon had visited the Bureau during a meeting of the American Physical Society in the late 1930s, at which time the Bureau was working on instrumentation for the detection of cosmic rays. He talked to Ellett about coming to work at the Bureau: "You know, I think I'd like to get in there and work on some of this cosmic ray stuff that I hear Diamond and Curtiss talking about." To which Ellett replied, "You don't want to go to that goddamn Bureau of Standards. All they do is sit around. They're a bunch of old fogies, dusting off the standards and trying to get another decimal point, and it's the most dreary place you could imagine working. How could you ever think about putting your career there?" And Huntoon continues, "[T]his was the university view of the Bureau of Standards. I've run into it at other places, in the prewar days, that it was a stultified, inactive, non-creative kind of a place. . . . So then I get into the old Bureau . . . I find this fantastic stuff that these old timers had done, [Edward] Rosa's work, and [Chester] Snow and the gravity guy, [Paul] Heyl. . . . These were very dedicated, capable guys of international reputations about whom nobody outside the favored circle ever seems to hear. . . ." Recollections similar to Huntoon's were expressed by Irl Schoonover.<sup>142</sup>

<sup>139</sup> House Committee on Appropriations, Subcommittee of the Committee on Appropriations, *Department of Commerce Appropriations for 1951: Hearings before the Subcommittee of the Committee on Appropriations*. 81st Cong., 2d sess., National Bureau of Standards, 23 February 1950: 2186.

<sup>140</sup> Annual Report, 1952: 1.

<sup>141</sup> Interview with Robert D. Huntoon, October 27, 1980: 21. (NIST Oral History File)

<sup>142</sup> Interview with Irl C. Schoonover, 3 June 1981. (NIST Oral History File). See also John Newhouse, *War and Peace in the Nuclear Age* (New York: Alfred A. Knopf, 1989): 22, for related comments by I. I. Rabi and John Manley.



When Condon, himself a world-renowned theoretical physicist, became director of the Bureau in November 1945, he recognized that the traditional peacetime functions of the Bureau, which had languished during the war, had to be revitalized. Moreover, the expansion of science, and the anticipated flourishing of new technology, required that the Bureau's research programs be modernized and strengthened. And the work of the Bureau had to be communicated to the scientific community, partly for increased effectiveness, partly to overcome the prewar image and partly to make the scientific staff broaden its outlook. Above all else, he wanted the Bureau to be an aggressive, vibrant institution with a wide audience, not a passive, inward-looking one, writing papers of interest only to a few narrow specialists. This new look, and the natural extrovert Condon himself, were a shock to many of the quiet, genteel, old-line staff.<sup>143</sup> He brought in Hugh Odishaw, his assistant at Westinghouse, to begin an aggressive program of communication and dissemination of the Bureau's scientific accomplishments. Largely a program of dissemination of the Bureau's scientific work, this activity was looked down upon by many of the old-line staff who thought of it as public relations. But, most important, he changed the direction and style of the Bureau by hiring bright, young, recently trained, modern scientists, with the aim of bringing the institution's scientific research into line with modern physics. It was relatively easy for the Bureau to hire such people. Condon himself, with his scientific reputation and vigor, was the magnet that attracted them. In line with his own scientific field, he began a program in applied mathematics, organized a division which in 1950 became the Atomic and Radiation Physics Division, put some of his best scientific people in its management, and peopled it with this new talent. This had created considerable resentment among some of the old-line staff, although by 1950 this had calmed down to a considerable extent. But the Bureau, while still a free, friendly, and cooperative place, had a new look, and the modernization of the research program was to continue for about ten years after Condon's departure.

In the immediate postwar years the Bureau was not a homogeneous institution; it consisted of several cultures. The principal division was into those persons who worked on military and atomic energy problems and were supported on funds transferred from the armed forces and the Atomic Energy Commission, and the "Old Bureau" persons who worked on the Bureau's unique measurement mission and were supported by directly appropriated funds. The "Old Bureau" was the portion Condon set about to revitalize. These groups not only had different masters; they were geographically separated. The "military" were located in the guarded, fence-enclosed Harry Diamond Ordnance Laboratory on the northwest 12.5 acres (5 hectares) of the

---

<sup>143</sup> Condon was accustomed to walking around the Bureau, dropping in unannounced on scientists working in their laboratories, and engaging them in a conversation about their work. His scientific powers were so great that he usually left them with new insight into what they were doing—even in fields that were not his specialty. There is, however, a story (probably apocryphal, but illustrative) about his dropping in on the Bureau glassblower, a notably crusty individual, as were many of the rest of the Bureau's craftsmen. The glassblower was constructing a complicated piece of apparatus out of fused quartz, a difficult and demanding task, requiring a hydrogen-oxygen flame. As Condon entered the shop, he stepped on one of gas supply lines, and the glass-blowing torch went out with a loud pop. Whereupon the craftsman turned around, looked at Condon, and said, "You clumsy oaf, can't you watch where you put your feet?" Condon walked quietly out. (Story told by John D. Hoffman.)



Dedication of the Harry Diamond Ordnance Laboratory in 1949.

Bureau site, with other contingents at the Institute for Numerical Analysis on the UCLA campus, and the guided-missile research laboratory at Corona, California. Somewhere between these two in function and philosophy was the Central Radio Propagation Laboratory (CRPL). Its Ionospheric Research Laboratory and Systems Research Laboratory—which carried out the “radio weather” prediction service—were closely aligned with military problems, while its Measurements Standards Laboratory was concerned with the Bureau’s traditional measurement and standards function, and hence aligned with the “Old Bureau.” A large portion of the work of the CRPL was carried out in field stations, and hence away from the main campus. And in the “Old Bureau” itself, there was a split between those who were doing scientific research in measurement problems (the “scientists”), and those concerned with the testing of Government purchases and the development of commodity standards (the “testers”).

The aims and views of the Bureau’s role and mission naturally differed from part to part. The “scientists” of the “Old Bureau” felt their role was to carry scientific research into new phenomena and areas which could be the source of new measurement methods and standards, while the “testers” were concerned with more empirical

test methods. The military people were concerned with carrying out the programs assigned to them by their supporters. The traditions of cooperation and freedom of work choice were not greatly different in the several parts, which was hardly surprising since all the management leaders came from the "Old Bureau." But the choice of work in the military part was more in the nature of devising ways to solve immediate technical problems than in formulating problems; they were engineers rather than scientists, doers rather than thinkers. And the two parts—except for their management—by and large kept to themselves. This was not surprising considering the strictures of geography and the requirements of secrecy.

While work choice had considerable latitude, cooperation was encouraged, and personal relations were courteous when not friendly. A number of amenities were missing from life at the Bureau. Because of the enormous growth that had occurred during the war, and even the more forceful growth to occur during the Korean War, space was at a premium. Even allowing for the propensity of scientists to act collectively like a gas and occupy all available volume, the Bureau laboratories were crowded and administrative games to obtain more space were usually in progress. Janitorial services were not all that could be desired. Offices were allowed only for section chiefs and division chiefs; scientists and their assistants (if the latter were lucky) had desks in the laboratories. But what inconvenience this may have caused during periods of reflection, analysis, and writing was mitigated by the close—if forced—interaction with colleagues.

Air-conditioning was not permitted for personal comfort, but was allowed if equipment requirements demanded it. Consequently there were a number of ingenious justifications for air conditioning because equipment suddenly became sensitive to the hot, humid Washington summers. But, like the rest of the Federal civil service force in Washington, workers were excused on particularly hot and humid days.

For those below the level of section chief, luncheon dining was a problem. On the Bureau grounds there were only two places where lunches could be obtained—a cafeteria that seated 150 persons in the Industrial Building where hot lunches could be purchased, and "the Hut," a temporary, sheet-metal canteen near the West Building which had no seating facilities. Here only sandwiches and snacks were available, but coffee could be obtained during the day. A charitable description of the food at the cafeteria was that it sustained life. These facilities were soundly criticized by the Congress.<sup>144</sup>

But if the luncheon facilities on the Bureau grounds were inadequate, Connecticut Avenue more than compensated. Here a number of restaurants in a whole range of prices were available, and a significant number of the Bureau staff were regular customers. But the time allotted for lunch was 30 minutes, and it was impossible to have lunch on the avenue in this length of time. Again this brought criticism from the House Appropriations Committee.<sup>145</sup> To a Bureau management that permitted scientists to set their own working hours, this cannot have been a serious concern, and doubtless was also not a serious concern to the Committee. But it was a useful point for criticism.

<sup>144</sup> Appropriations Hearings for 1951: 2226.

<sup>145</sup> *Ibid.*, 2227.

For division chiefs, section chiefs, and a few senior scientists, luncheon problems were mitigated. This group had formed a dining club, called the Senior Lunch Club, that met for lunch in a dining room on the fourth floor of the South Building. The South Building was the first Bureau building erected and, along with laboratories, housed the Bureau administrative offices. Membership in the club was by invitation, and a modest monthly fee covered the cost of meals. The meal was prepared by a caterer under contract to the club and served boarding-house style at a number of tables, each seating eight persons. It was an excellent place for these Bureau leaders to exchange ideas and discuss technical and administrative matters. One of the rules of the club was that seating was at random but this rule was not strictly obeyed. A number of members occupied the same places daily, and two of the tables were always occupied by the same persons. If a new, uninitiated member inadvertently occupied one of these "reserved" places, he or she would not be asked to move. This would be against the club rules, and moreover would be discourteous. The offended member, often in a surly mood, went to sit somewhere else, and cases are recalled when such a member stomped out of the club in a huff. A new initiate quickly learned the rules, and it was a good place to learn the power structure of the Bureau and what was going on. The food was not always in overabundance, leading to occasional caustically humorous comments about members with large appetites, but it was nourishing and often tasty.



The NBS Senior Lunch Club provided an opportunity for NBS senior staff to meet and exchange ideas in an informal setting.

Despite the lack of these few amenities, the Bureau of 1950 was a good place to work. A scientist had considerable opportunity to follow his or her own ideas, there were expert colleagues with whom one could consult and possibly cooperate with on technical problems, and the director was a famous scientist who was revitalizing the organization. It was a good place to interact with the scientific community. The American Physical Society always held sessions in the auditorium in the East Building during its spring meeting when Washington was at its flowering best. There was a constant stream of foreign and domestic visitors, many of whom gave colloquia at division meetings, and every Friday morning there was a colloquium for the whole Bureau staff. This was sometimes presented by staff members who had done particularly meritorious work, and sometimes by invited distinguished visitors. And arrangements could be made with one of the local university professors for younger staff members to use their research work at the Bureau for a Ph.D. or master's thesis. It was an attractive place for the recent, well-trained graduate.

But there were some problems. The loyalty investigations begun in 1947 had caused some members of the Bureau staff to resign, and others had passed some trying days of investigation. Some prospective employees, possibly because of previous injudicious or ideological associations, or possibly because of the rigors of investigation, were dissuaded from applying for positions. The director of the Bureau, in these early days of McCarthyism, was himself under a loyalty cloud. And, unknown to the prospective employee and even to most of the Bureau staff, a problem, concerning of all things a battery additive, was beginning to fester. This would cause the Bureau some of its most trying days.<sup>146</sup>

---

<sup>146</sup> Along with sources identified in subsequent footnotes, much of this material comes from interviews with Churchill Eisenhart, Everett G. Fuller, Karl G. Kessler, John A. Simpson, and W. Reeves Tilley.

---

## CHAPTER TWO

---

### TESTING CAN BE TROUBLESOME

After World War II, testing commodities for conformance with specifications in Government purchases, and testing services for regulatory agencies were only a small part of the Bureau's activities. Thus, in 1952, the total expenditures for this type of work were about 1 percent of the total budget. Testing for agencies with regulatory responsibilities, principally the Federal Trade Commission (FTC, concerned with misleading advertising claims), and the Post Office Department (POD, concerned with mail fraud), was indeed a small amount of work, amounting to only a twentieth of 1 percent, or \$25 000.<sup>1</sup> Nevertheless, this monetarily small effort contained within it the seeds of controversy and embarrassment. If the Bureau were publicly to identify a proprietary product that did not meet specifications or advertised claims, it could be accused of unfairly treating the product, and its results could be subject to questioning. If it gave public approval of a product, competing manufacturers could complain of unfair treatment. And if the Bureau condemned a class of materials without naming specific manufacturers, the latter could—and some did—claim that their product was different, hence the Bureau's results did not apply to it.

In a number of cases in the Bureau's history it was led into controversy by this testing activity and subsequent publication of the results. The best-known incidents were the testing of Aquella, a waterproofing paint, and Battery AD-X2, a battery additive that, under some circumstances, allegedly revived old, "dead," lead-acid batteries. The Aquella incident was relatively minor, causing not a great deal more than embarrassment for the Bureau. The Battery AD-X2 controversy, on the other hand, was serious indeed. It caused the firing of the Bureau's director, followed eventually by full reinstatement; prompted the investigation of the Bureau by two high-level committees and brought about dramatic changes in its programs; provoked a furor in the whole scientific community and led a large number of the Bureau staff to threaten resignation; resulted in six days of hearings before a Senate select committee; made the Bureau and its director front-page news for months; brought about the resignation of an assistant secretary of commerce; and (in part) caused the transfer of 2000 persons from the Bureau to newly formed military laboratories.

The stories of the two incidents are instructive in illustrating the kind of problems that can—and did—occur as a result of commodity testing. The common element that connects the two cases is the publication of the results in a form available to the general public.

---

<sup>1</sup> Senate Select Committee on Small Business. *Battery AD-X2: Hearings Before the Select Committee on Small Business, United States Senate, Eighty-third Congress, first session, on Investigation of Battery Additive AD-X2, March 31, June 22, 23, 24, 25, and 26, 1953*: 212. Hereafter this document will be referred to as "AD-X2 Hearings."

## POLICIES ON COMMODITY TESTING AND PUBLICATIONS

The Bureau's policy on this testing and on the resulting publications is of crucial importance, and is made clear by testimony before the Senate Select Committee on Small Business in 1953, by Dr. Allen V. Astin, Bureau director from 1951 to 1969:

Frequently, in the course of its testing work, the Bureau accumulates general information on classes of materials and products that is of interest and importance to the public. In many of these cases, publications are prepared for general distribution in which references to specific proprietary products is avoided. Occasionally there are publications, in which brand name products are identified, but this is done with the consent and cooperation of the manufacturers involved. A notable example is in the publication of data on the acoustical properties of materials. These data are determined at the joint request of building and manufacturing groups, and the results are of appreciable value to architects and construction engineers in their design problems. But even in this case no attempt is made to provide an overall evaluation or an approval of a particular item. Also in such cases the Bureau does not permit the use of its name by manufacturers for advertising or promotion purposes.<sup>2</sup>

The Bureau's information was published in any of a number of publication series, but always in the form of booklets or pamphlets which could be purchased from the Government Printing Office for a few cents each.<sup>3</sup> So extensive were these publications that in 1940 a special Letter Circular, LC 586, "List of Publications of Interest to the General Public," was published. In 1942 this was superseded by LC 696 which listed approximately 1200 publications, not all of them based on Bureau testing.<sup>4</sup> A tabulation of a few of the titles gives an indication of the topics covered:

<sup>2</sup> A. V. Astin testimony, AD-X2 Hearings: 213. The publications in which proprietary names were used were a separate series, the Building Materials and Structures Reports, published from 1938 to 1959. These were part of a program begun by the Bureau in 1937 to provide technical information to all parties in the building industry on building construction materials for use in low-cost housing. This work was decidedly different from commodity testing. First, the materials for test did not come from another agency, but were voluntarily submitted by the manufacturer. Second, this was not testing to see if a material complied with a specification. In fact, no specifications existed, and part of the effort was to obtain enough information to write a specification. Until 1947, each publication contained the statement, "The National Bureau of Standards is a fact-finding organization; it does not 'approve' any particular material or method of construction. The technical findings in this series of reports are to be construed accordingly."

<sup>3</sup> The various publication series of the Bureau are described in Appendix H.

<sup>4</sup> Along with about 800 Federal Specifications (most of them for foodstuffs), LC 696 listed 45 Commercial Standards and 60 Simplified Practice Recommendations. Not all of these publications were based solely on Bureau work, but there were about 300 that were. Thus LC 696 cataloged 19 Circulars (C); 41 Research Papers (RP); 20 Miscellaneous Publications (M); 4 publications in the Building and Housing Series (BH); 3 Handbooks (H); 85 Letter Circulars (LC); 61 publications in the Technical Information on Building Materials Series (TIBM); and 89 in the Building Materials and Structures Series (BMS).

U. S. DEPARTMENT OF COMMERCE  
HARRY L. HOPKINS, Secretary  
NATIONAL BUREAU OF STANDARDS  
LYMAN J. BRIGGS, Director

CIRCULAR OF THE NATIONAL BUREAU OF STANDARDS C424  
(Supersedes Circular C283)

### WASHING, CLEANING, AND POLISHING MATERIALS

By F. W. Smither

U. S. DEPARTMENT OF COMMERCE  
R. F. LAMONT, Secretary  
BUREAU OF STANDARDS  
GEORGE K. BURGESS, Director

CIRCULAR OF THE NATIONAL BUREAU OF STANDARDS, No. 397  
(Supersedes Circular No. 78)

### SAFETY FOR THE HOUSEHOLD

UNITED STATES DEPARTMENT OF COMMERCE • Charles Sawyer, Secretary  
NATIONAL BUREAU OF STANDARDS • G. S. Gordon, Director

### Battery Additives

# Automotive Antifreezes

by Donald B. Brooks and Ronald E. Streets



National Bureau of Standards Circular 474  
Issued November 10, 1948

UNITED STATES GOVERNMENT PRINTING OFFICE: WASHINGTON : 1948  
For sale by the Superintendent of Documents, U. S. Government Printing Office, Washington 25, D. C.  
Price 15 cents

NBS was not a regulatory agency. The Bureau never tested proprietary products unless requested to do so by another government agency with regulatory powers, such as the Federal Trade Commission or the Post Office Department, or by an agency interested in purchasing such products. Occasionally NBS published information that it had obtained on a class of products when that data was thought useful to the general public. References to specific brand names were avoided except with prior agreement by the interested parties.



- *Safety for the Household*, C 397
- *Washing, Cleaning, and Polishing Materials*, C 424
- *Automotive Anti-Freezes*, C 474<sup>5</sup>
- *Accelerated Weathering Tests of Mineral-Surfaced Asphalt Shingles*, RP 1002
- *Charts for Testing Lens Resolution*, M 166
- *Care and Repair of the Home*, BH 15
- *Sun Lamps, Health Lamps; Carbon and Mercury Lamps*, LC 631
- *Automobile Engine Lubricating Oils*, LC 613
- *Painting Steam and Hot Water Radiators*, LC 445
- *Corrosion of Metals Used in Home Construction*, TIBM 1.

Practically oriented and simply written, some of these publications were very popular indeed. *How to Own Your Own Home*, BH 4, issued in 1923, sold 100 000 copies in the first week of its publication, and 300 000 by the end of the year. It was serialized in several newspapers and magazines.<sup>6</sup> *Care and Repair of the Home*, BH 15, first issued in 1931, sold more than 500 000 copies by 1940. But it raised a furor in the building-repair trades that was not lessened by the Bureau's aggressive advertising campaign and a Doubleday Doran hard-cover edition.<sup>7</sup>

While these booklets contained information of value to the Nation, there were always potential problems for the Bureau inherent in their publication. The case of a water-repellant paint, "Aquilla," illustrates some of the problems that could arise.<sup>8</sup>

#### THE AQUILLA INCIDENT

During May and June 1942, Leandro W. Tomarkin, a Swiss scientist, visited the Bureau several times. He told then Bureau Director Lyman J. Briggs about a waterproofing paint developed by a French paint manufacturer, Rene Hagenauer. Both

<sup>5</sup> This circular, issued in 1948, so appealed to Director Condon that he wrote to Secretary of Commerce Sawyer requesting permission to send a copy to each member of the Cabinet. Whether such permission was granted and copies sent is not known. (NARA; RG 167; Records of the Director; Box 6; Folder D/IG)

<sup>6</sup> MFP, 251.

<sup>7</sup> *Ibid.*, 252-253.

<sup>8</sup> Memorandum, from Douglas E. Parsons to Bureau Director Allen V. Astin, "The Aquilla Case," April 15, 1953. (NARA; RG 167; Astin file; Box 2; Folder Controversies). This memorandum and associated documents are the main sources for the account given here. At the time the memorandum was written, Parsons was chief of the Building Technology Division. From 1930 to 1945 he was chief of the Masonry Construction Section in which the work to be described was performed. Another perspective is given by Cochrane in MFP, 482-483, 487.

Tomarkin and Hagenauer were immigrants living in New York.<sup>9</sup> The paint had presumably been used to waterproof structures in the Maginot line. Tomarkin claimed no financial interest in the product and asked Briggs to test it. Concerned with the "need for a low-cost waterproofing [material] for the hastily built wartime structures, Briggs agreed that the NBS would examine a sample of the material which Tomarkin offered to supply."<sup>10</sup>

The policy on carrying out tests for private individuals, as later enunciated by Allen V. Astin, was:

in the commodity-testing activity similar services are frequently available in private testing laboratories; therefore, the Bureau's work in this area is confined to serving other Government agencies in connection with their purchasing or regulatory responsibilities. Occasionally a testing problem arises where the Bureau's facilities are unique or where its services are desired for referee purposes, and under such circumstances a commodity test might be performed for the general public.<sup>11</sup>

In agreeing to test Aquella, the Bureau was not conducting a referee test. Since the facilities for carrying out the test were rather routine and available from any well-equipped testing laboratory, so it can be surmised that Briggs was spurred by wartime pressures into carrying out a test for a private individual. As will be discussed later, however, there is some evidence that Briggs may also have had requests from other agencies for this testing.

A small sample of the material was provided by Tomarkin and Hagenauer, and a chemical analysis was performed on it. This "indicated that it was a cement-water paint similar to some products made in the USA."<sup>12</sup>

With larger samples of Aquella provided later, wall permeability tests were carried out on two brick and two concrete block walls during the summer of 1942. Tomarkin and Hagenauer helped in the tests. In response to a letter from Tomarkin of September 2, 1942, on September 7 the Bureau wrote in reply, "Pending the issuing of a complete report . . . the performance of the wall was rated 'excellent.' Please be particular to bear in mind that this information is confidential and is not to be used for advertising, publication or sales promotion."<sup>13</sup>

On December 8, a report (hereafter referred to as the "early report") on the performance of the paint was written.<sup>14</sup> In it, Tomarkin was now identified as director,

---

<sup>9</sup> MFP, p. 482.

<sup>10</sup> Parsons, "Aquella Case."

<sup>11</sup> A. V. Astin testimony, AD-X2 Hearings: 212-213.

<sup>12</sup> Parsons, "Aquella Case."

<sup>13</sup> Letter, NBS to L. W. Tomarkin, September 7, 1942. (NARA; RG 167; Astin file; Box 2; Folder Controversies)

<sup>14</sup> *Report of Water Permeability Tests on Coatings of "Aquella" Paint Applied to Masonry Walls*, submitted by L. W. Tomarkin, Director, Center for Applied Scientific Research and Industrial Technology, New York, N.Y. (NARA; RG 167; Astin file; Box 2; Folder Controversies)

Center for Applied Scientific Research and Industrial Technology of New York City, and Hagenauer as the president of Special Paint Cie, which had manufactured and supplied the paint. In the report, the two walls treated on the exposed surface were rated as "excellent," and the two treated on the unexposed surfaces rated as "good" after a second coat. Despite the fact that such tests were normally carried over several years of exposure, and these results were only for tests conducted in July and August 1942, the report is not labelled as preliminary, nor the results otherwise qualified. It does, however, contain the notice, "The contents of this report are confidential and are not to be used for advertising, publication or sales promotion." Copies of the report "were sent to a few representatives of other Government agencies, and one was given to Dr. Tomarkin."<sup>15</sup>

Apparently influenced by the report, the Federal Trade Commission (FTC) asked for later results. Such a report, which included results from tests made in May 1943 (still representing only eight months of exposure), was issued on June 4, 1943. This will be referred to as the "later" or "final" report. There was a decided change in the results. Three of the four walls were now rated "good," and one was rated "poor." No longer were two walls rated "excellent." It is not known if this later report was sent to Tomarkin, but the bulk of the record indicates that it was not. Indeed, if the FTC had contracted for the extended work, it would have been against Bureau policy to send the report to anyone but the contracting agency. The Bureau's position was that the report became a property of the requesting agency, and any distribution was up to that agency.

Six months later things began to get more complicated. Briggs received a letter dated January 7, 1944, from Harris H. Murdock, Chairman of the Board of Standards and Appeals (BSA) of New York City. Murdock wrote that he had seen a copy of the December 8, 1942, report, and was in accord with the paragraph warning of its confidentiality and against the use of the results for advertising, publication, and sales promotion. He asked, however, if the report could be referred to or quoted from "when we have occasion to approve for use . . . a material . . . on which you have reported and this Board's action might be based . . . on your findings."<sup>16</sup> Briggs immediately wrote back that "it would not be in the public interest for you to publish quotations from the report. . . ." He pointed out that there was no assurance that the product was the same as that which the Bureau had tested. Nevertheless he had "no objections to the use of our report in memoranda or reports from employees or officials of the City of New York addressed solely to other officials."<sup>17</sup> Briggs' letter says nothing about the later report.

The early report was to go much further. Indeed, on September 23, 1943, almost four months before the Murdock letter, but three months after the Bureau's later report, the Modern Waterproofing Paint Company, now manufacturing Aquella, had applied to

---

<sup>15</sup> Parsons, "Aquella Case."

<sup>16</sup> Letter, H. H. Murdock to L. J. Briggs, January 7, 1944. (NARA; RG 167; Astin file; Box 2; Folder Controversies)

<sup>17</sup> Letter, L. J. Briggs to H. H. Murdock, January 12, 1944. (NARA; RG 167; Astin file; Box 2; Folder Controversies)

the BSA to have its product approved. Tomarkin appeared before the Board for the applicant. On June 6, 1944, in the *Bulletin of the Board of Standards and Appeals*, an account of the petition was given, the December 8 report was published in full, and the use of Aquella was approved. No account of the Bureau's later tests was given. The Bureau's early results on a proprietary product were available to whomever would seek them, but the full testing results were not.

In due course Briggs learned of the Bulletin announcement and received a copy of it from Murdock on May 31, 1945. Briggs wrote back, with copies to the paint manufacturers, pointing out the results of the later tests and the consequent misleading nature of the Bulletin account.<sup>18</sup> He also wrote about the origin of the tests. "The tests of 'Aquella' were made to obtain technical information for Government agencies which had expressed an interest in the product, and for certain other special reasons." Briggs did not say that other agencies had commissioned the tests, and he does not say what the "other special reasons" were. He wrote further what was really the crux of the matter:

With some justification, manufacturers of products which compete with "Aquella" might claim that the publication of excerpts of our report on "Aquella" is not fair to them unless similar reports on their products are issued and published. Obviously, this would be very difficult and . . . would be contrary to the policy of this Bureau.

Nothing further happened on this front.

On the legal front, however, things did happen. The FTC issued a complaint against the Modern Waterproofing Paint Company, specifically citing Tomarkin along with four other individuals.<sup>19</sup> The basis of the complaint was that the:

respondents represent . . . that their said paint product is an effective waterproofing material or compound. . . . The foregoing statements and representations made by the respondents in connection with the promotion of sale and sale of their said product are false, misleading and deceptive.

This action by the FTC continued until June 1, 1953, when the respondents were ordered to cease and desist from various representations of their product.

But before this happened, there was another episode in the Aquella affair. The December 15, 1945, issue of *Forbes* contained an article by Kurt Steel entitled "Dry Cellars," and the January 1946 issue of *Reader's Digest* (which appeared on the newsstands before the *Forbes* issue) contained an abstract of the *Forbes* article by the same

---

<sup>18</sup> Letter, L. J. Briggs to H. H. Murdock, June 12, 1945. (NARA; RG 167; Astin file; Box 2; Folder Controversies)

<sup>19</sup> Federal Trade Commission Complaint, Docket No. 5364, "In the Matter of Ira A. Campbell, Leandro W. Tomarkin, Wanda Tomarkin, Zella Fay Campbell, and Zella Clarke, individually and trading as Modern Waterproofing Paint Company," August 10, 1945, paragraphs 4, 5. (NARA; RG 167; Astin file; Box 2; Folder Controversies)

author entitled, "Water, Stay Away From My Wall." Both articles were highly laudatory of Aquella, and "contained misstatements of fact about the Bureau's tests and data."<sup>20</sup> Almost immediately, on December 29, 1945, Edward U. Condon, who had succeeded Briggs as director in November, wrote a letter to *Forbes*, with a copy to *Reader's Digest*, pointing out the inaccuracies in the published article, and containing the statement, "The coatings of Aquella . . . were found to be no more effective as waterproofings than coatings of other products. . . . [T]ests . . . for eight or more months indicated that the Aquella coatings had become less effective . . . than were some of the laboratory-mixed cement-paint coatings. . . ." He promised to send copies of the letter to "those who request information about Aquella." And more than 20 000 did so. They were sent copies of Condon's letter. This did not sit well with some people. Aquella was a hot item, and many persons were seeking distributorships. Thus, Georgia Governor Ellis Arnall, speaking on behalf of prospective distributors in his State, contacted Secretary of Commerce Henry A. Wallace about the problem.<sup>21</sup> Wallace wrote to the manufacturers of Aquella recalling and retracting the Condon letter. The Bureau stopped sending it out in response to requests about Aquella, and instead sent a summary of the experimental results.<sup>22</sup> Except for sending some of its staff as expert witnesses in the continuing FTC Hearings, the Bureau's effort in this incident ended.

The Aquella incident was not a world-shaking event. The manufacturers of Aquella were ordered to "cease and desist" in their advertising claims, but the Bureau suffered no lasting harm from the experience. Certainly it suffered some embarrassment, particularly in having a letter of its director retracted by the secretary of commerce, but this was not a lasting injury. There are, however, some lessons to be learned from the affair. The Bureau's technical results were never questioned. The results of its work, in both reports, were accepted, but this illustrates that a great deal of trouble can be caused even if the technical work is correct. And the incident illustrated the great power of Bureau publications. One of its reports—whether misused or not—helped gain a manufacturer approval of its product for use by the New York City government, and caused thousands to write to the Bureau for information.

But the most important lesson was the scrupulous care the Bureau needed to take with the results of testing of proprietary products. While the record is not clear on all aspects of the history of the incident, it well illustrated the problems inherent in carrying out tests for a manufacturer who is inevitably not a disinterested party. Such testing was against long-standing Bureau policy. While there is some evidence in

---

<sup>20</sup> Parsons, "Aquella Case."

<sup>21</sup> Letter, E. U. Condon to Forbes Publishing Co. and *Reader's Digest*, December 29, 1945. (NARA; RG 167; Astin file; Box 2; Folder Controversies); MFP, 483.

<sup>22</sup> Letter, H. A. Wallace to Milton F. Schreyer, President of Prima Products, Inc. (now the manufacturers of Aquella), June 3, 1946. The letter contains the statement, "The Bureau stands upon the complete report of water permeability tests on coatings of 'Aquella' paint as applied to Masonry walls dated December 8, 1942, on file in the office of the National Bureau of Standards." (NARA; RG 167; Astin file; Box 2; Folder Controversies); Summary of "Water-Permeability Tests of Coatings of 'Aquella' Applied to Masonry Walls." August 9, 1946. (NARA; RG 167; Astin file; Box 2; Folder Controversies)

Briggs' June 12, 1945, letter to Murdock that there was some interest from unspecified other Government agencies, it is not clear that the tests were done at their request. If, in fact, another agency had contracted for the work, the Bureau would have sent its report only to that agency. It thus appears that the main instigator of the work was Tomarkin, and not another Government agency. He provided the material, assisted in the application along with Hagenauer, and received a copy of the report. Very likely only wartime necessity caused Briggs to go against the Bureau's policy.

The incident also illustrates well the meticulous handling required of reports that name proprietary products. Certainly the fact that the 1942 report was not prominently labelled "preliminary" can only be described as an oversight. And, in this day of the Freedom of Information Act, the injunction against publication of the results, or their use for sales promotion, sounds ingenuous. But perhaps the most serious problem was the handling of the final report. It is not clear that Tomarkin was ever sent a copy, or that he was notified that the results of the earlier report were superseded. Thus, Tomarkin and his associates could have considered the first report as the final word and used it in a low-key sales promotion before the BSA. This led to the publication of the early report as gospel, and to the two feature articles, however inspired. In due course—and certainly after the June 12, 1945, letter from Briggs to Murdock—the manufacturers learned of the Bureau's final report, but apparently continued their advertising claims until the "cease and desist" order. Had the Bureau made sure that the manufacturers, and the BSA, received a copy of the final report, some of the events in the Aquella affair might have been precluded.

#### **THE BATTERY ADDITIVE INCIDENT**

While the Aquella affair caused the Bureau some embarrassment, it left no permanent scars, nor caused any changes in its programs. This was not the case with the similar, but far more serious, affair caused by the testing of a material—a "battery additive" marketed under the name "Battery AD-X2"—which, when added to a lead-acid battery, allegedly improved its performance and, under some circumstances, could presumably revive a "dead" battery. This incident was to cause major changes in the Bureau's programs. Also, unlike the Aquella affair, in the battery additive incident the Bureau's technical results were severely questioned. At the heart of the matter was the fact that AD-X2 had many satisfied users, while the Bureau—mostly on the basis of its own laboratory results—steadfastly maintained that it was "not effective." The question was not that the product was harmful; had it been, there would have been no incident, for it would not have lasted on the market. Rather the question was, "Did the product do anything that could not have been obtained without using it?" The Bureau was caught in the uncomfortable position of having to prove a negative, for if a set of experiments showed the product to be ineffective, it could always be argued—and was—that a different set would show otherwise.

The Battery AD-X2 affair began in 1948 and reached a climax in 1953, but the story properly begins with the Bureau's activities in battery research and testing.



Jess M. Ritchie's photograph appears to give credibility to the claims below it. The Bureau's analysis of AD-X2 showed that the material was primarily a simple mixture of sodium and magnesium sulfates with a number of trace elements usually found in battery additives. Results of tests showed that the effect of AD-X2 in a battery electrolyte was no different from that of other mixtures of sodium and magnesium sulfates and that none had any measurable effect on the performance of a lead-acid storage battery.

#### BATTERIES AND BATTERY ADDITIVES

The Bureau, driven by the need for a stable and reproducible electrolytic cell as a standard for the volt, began research in electrochemistry in its earliest days. It did not, however, begin research on batteries until 1917, when it was driven to it by wartime necessity. The Annual Report for Fiscal Year 1918 announced:

The need of the development of specifications and methods of testing for electric batteries has long been recognized; but facilities have not been available to undertake this work. The needs of the military departments have recently become so urgent that the study of batteries has been undertaken.<sup>23</sup>

These studies were to continue for more than fifty years. Beginning with dry cells, the work rapidly expanded to include all types of batteries: automotive type batteries, aircraft batteries, truck batteries, railroad batteries, dry cells, lead-acid storage batteries, alkaline batteries, and reserve or "delayed-action" batteries. There was practical work on testing methods and a great deal of testing for other agencies, basic research on electrode reactions, the effect of impurities in the electrolyte and in the battery plates, and the study of various materials. At the request of the military, a small-scale battery-manufacturing plant was set up to make lead-acid battery plates for experimental purposes. There was hardly a phase of battery science and technology not known to the Bureau.

<sup>23</sup> Annual Report, 1918: 48.

Carried out in the Electrochemistry Section of the Electricity Division, the continuity of the battery work was rivaled only by the work on basic measurement standards. From 1918, when battery research began at the Bureau, until his retirement in 1950, George W. Vinal was chief of this section. He came to the Bureau in 1908, and had a stay of forty-three years, all of them devoted to various aspects of electrochemistry and batteries. In 1924 he published the definitive text, *Storage Batteries*, which went through four editions, the last in 1955.<sup>24</sup> Upon his retirement, he was succeeded by Walter J. Hamer, another eminent electrochemist. After receiving his Ph.D. in 1932 from Yale University for work on electrolytes and the ionization of water, Hamer spent three years doing post-doctoral work—two years working on the thermodynamics and physical chemistry of electrolytes and a third on non-electrolytes and electrolytes, including those used in lead-acid batteries. He joined the Bureau in 1935. By the time he succeeded Vinal, he was widely recognized for his investigations of electrolytes, storage batteries, dry cells, and the electrometric determination of acidity. He was to remain chief of the Electrochemistry Section until his retirement in 1970, at which time the section was disbanded. Thus, for fifty-two years all the work on batteries was under the direction of two distinguished scientists. Both were to play central roles in the AD-X2 affair.



George W. Vinal served as the chief of the Electrochemistry Section from its formation in 1918 until his retirement in 1950. He was internationally recognized for his research in the field of electrochemistry, particularly for his work in the development and perfection of the silver voltmeter and the standard cell which served as standards for the international ampere and volt.

<sup>24</sup> G. W. Vinal, *Storage Batteries* (New York: John Wiley and Sons, 1924).





Walter J. Hamer was chief of the Electrochemistry Section from 1950 to 1970 where his main responsibility was the maintenance of the Nation's primary standard of electromotive force. He was recognized for his extensive research in standard cells, primary and secondary batteries, and electrolytic solutions, and later in work relating to the National Standard Reference Data System.

Not only did the Bureau test batteries for other agencies, but it also tested battery additives. Introduced as early as 1915, these were proprietary chemical preparations of assorted kinds reputed to have beneficial effects on various aspects of battery performance. Some were solids to be added to the battery electrolyte, and some were liquids (usually sulfuric acid solutions) to replace the electrolyte. Testing of these products began in 1919 and continued until 1957,<sup>25</sup> although the Bureau continued to provide expert witnesses until 1971. Never was an additive found that had a beneficial effect. Many of them were simple mixtures of magnesium and sodium sulfates (Epsom and Glauber's salts, respectively), and were uniformly found to be without merit, but not necessarily harmful.<sup>26</sup> Indeed, the ineffectiveness of these compounds had been known since 1902.<sup>27</sup> Others contained iron salts or halogen compounds and were actually harmful.

<sup>25</sup> "Table: Lists of Tests of Battery Additives." This table gives a tabulation of all the battery additives tested by the Bureau from April 1919 to March 1952. (NARA; RG 167; Astin file; Box 10; Folder Pioneers & Ritchie)

<sup>26</sup> Strictly speaking, Epsom and Glauber's salts contain water of crystallization, the formulas being  $\text{MgSO}_4 \cdot 7\text{H}_2\text{O}$  and  $\text{Na}_2\text{SO}_4 \cdot 10\text{H}_2\text{O}$ , respectively. Heating can partially or totally drive off the water. If all the water is driven off, the anhydrous salts are obtained. When dissolved in water or in storage battery electrolyte, the solutions obtained from any of these states of hydration are identical, provided only that allowance is made for the weight of water to obtain specified concentrations.

<sup>27</sup> Vinal, *Storage Batteries*, 1955 ed.: 157.

It is important to note that one of the very first tests conducted was for the Associated Advertising Clubs of the World, an organization concerned with truth in advertising. Associated with this organization were Better Business Bureaus (BBBs). These business-supported agencies were organized to protect responsible business and consumer interests, and published periodicals on items of interest to the consumer. Of concern to the BBBs was truth in advertising, and they were to play a central role in the battery additive incident.

As early as 1925, the Bureau published an article in its *Technical News Bulletin* entitled "Solutions Do Not Charge Storage Batteries." The article states:

Comparison was made between batteries containing these solutions and similar batteries containing electrolyte of sulphuric acid of equivalent strength. No essential differences were shown in the charging, the voltage, the efficiency, or the temperature.<sup>28</sup>

Work continued, and by 1931 the Bureau had tested more than a dozen additives, the majority of them for the FTC and the POD. More than 100 had been brought to its attention. Because of the large number of requests for information on these additives, in that year it issued Letter Circular (LC) 302, *Battery Compounds and Solutions*. This document was sent in response to those requests. Referring to the 1925 publication, the letter circular states, "The later tests confirm the Bureau's previous conclusions that these materials do not charge storage batteries nor do they materially improve the performance of the batteries." The last phrase clearly shows how the Bureau was in the position of having to prove a negative.

In effect, LC 302 condemned all battery additives, but never named a proprietary product. In 1940, the National Better Business Bureau, which had been condemning battery additives since the 1920s, used the Letter Circular to prepare its own publication, *Facts About Battery Dopes*, further—and soundly—condemning battery additives. Using section titles such as "Useless or harmful—say manufacturers"; "'Debunking' claims for battery 'dopes'"; "No 'dopes' for Uncle Sam"; "Drugstore magic"; and "Trick tests and testimonials," it quotes a manufacturer:

To date there has been nothing found which can be added to the electrolyte of a storage battery which will facilitate charging or increase the life of a storage battery. . . . battery dope[s] . . . are either harmful to the life of a storage battery or have no material effect either on the life or on the charge of a battery.<sup>29</sup>

The document also quotes Lyman J. Briggs, then the director of the Bureau (which it calls "The highest impartial scientific authority in the United States on storage batteries") as follows:

---

<sup>28</sup> "Solutions Do Not Charge Storage Batteries," *Technical News Bulletin*, No. 94, (February 10, 1925): 1-2.

<sup>29</sup> National Better Business Bureau, *Facts About Battery Dopes*. (AD-X2 Hearings: 41)

It is, of course, possible that some material may eventually be found which would relieve the difficulties arising from abnormal operation of storage batteries, but none of the exploited materials which have been tested here have had any such merits. . . .

. . . Carefully controlled tests are necessary in order to determine these points definitely and *none of these materials which have been tested here have produced any beneficial effect when added to the regular electrolyte. Some are definitely harmful.*

The publication was a thorough condemnation of battery additives, and much of it was based on the Bureau's work.

#### A SHORT TECHNICAL NOTE

Unlike the Aquella incident, in the AD-X2 controversy the Bureau's technical results were questioned, and seriously so. To be able to understand the issues pro and con of the Bureau's results, it is well to review briefly some facts about lead-acid batteries and the methods for testing them. The uninterested reader may skip this section and continue with the main text.

Figure 1 shows a cutaway view of a prototypical automotive lead-acid battery. The battery consists of a number of cells—three for a nominal 6-volt battery and six for a

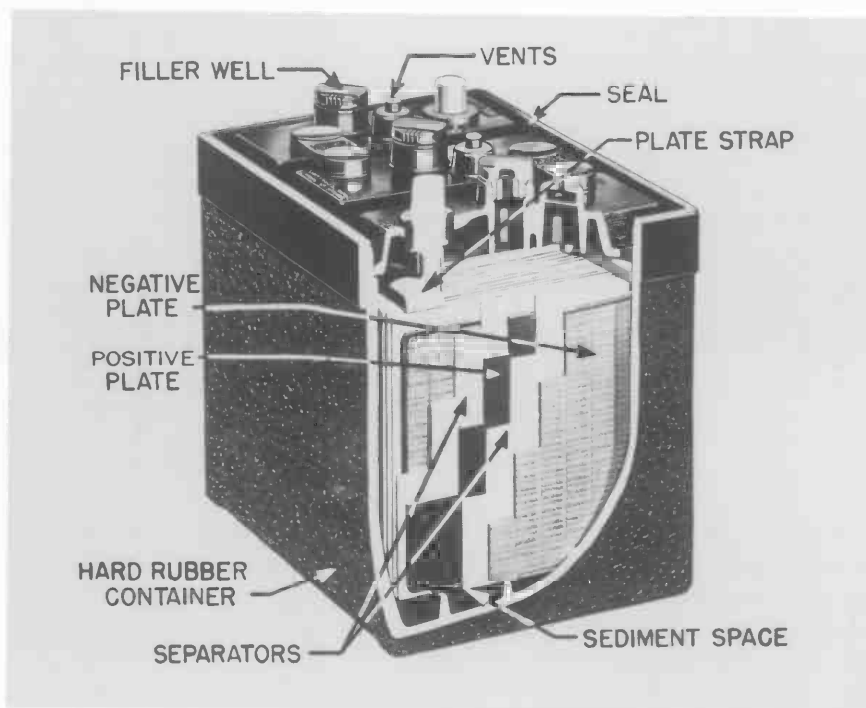

Figure 1. Cutaway view of a 1953 automotive lead-acid battery.

nominal 12-volt battery. Each cell consists of two electrodes—one positive and one negative—separated by a porous separator, often wood in the late 1940s and early 1950s, or one of various porous plastic materials. Current flows from the positive to negative electrodes in the external circuit and from negative to positive in the cell. The cells are filled with an electrolyte of dilute sulfuric acid to which the separator is highly permeable. The electrodes are made of lead-alloy plates, and each is formed into a grid to increase its surface area. These plates are covered with a highly porous paste whose composition is different for the two electrodes.

In a completely charged battery, the paste on the positive electrode consists of lead dioxide, while that on the negative electrode consists of spongy lead. These are called the “active materials.” During discharge, the paste on both the positive and negative electrodes is converted to lead sulfate. This process is called “sulfation” and is completely normal, but the term has another, and more subtle, meaning as will be described below. The sulfate comes from reactions with the sulfuric acid and water in the electrolyte and, as discharge proceeds, the acid concentration in the electrolyte decreases, and hence the specific gravity also decreases. These reactions provide the electromotive force that moves current through the external circuit. In a discharged battery, the paste on both electrodes is essentially lead sulfate. No further reaction can take place, and the battery can provide no electrical energy. In charging the battery the reverse reactions occur, and the positive and negative electrodes are converted back to their original condition. This is normal operation, except that the battery is not normally completely discharged.

So far, these are accepted facts, and there are no questions. The heart of the argument concerns the question of “sulfation,” and to understand this, it is important to review the reason for having a paste on the electrodes at all, rather than, say, making the electrodes (of automotive batteries) out of solid plates of the respective materials. The paste of active materials on both electrodes consists of very fine particles. These have an extremely high surface area, and hence the material of which they are composed is easily accessible to the electrolyte on either charging or discharging, and the appropriate chemical reactions can readily take place. However, if a fully (or even partially) discharged battery is stored for a long period, the fine particles (really fine crystals) of lead sulfate in the paste on both electrodes grow in size. As they do, the material in them becomes less and less accessible to the electrolyte, for either charge or discharge. The soft paste is converted to a hard, compact mass only slightly permeable to the electrolyte. In the second, and more subtle meaning of the term, such a battery is also said to be “sulfated,” even though not all of the active material is used up. Such a battery delivers little or no current, and is difficult to charge. Charging can, however, be carried out, and its efficiency is increased if it is done slowly and with cycling between charging and discharging steps. This is normal, and requires no additions to the battery, except possibly water if for some reason the battery has gone dry or the level of electrolyte is too low.

The proponents of battery additives (particularly those composed of Epsom and Glauber’s salts) claimed that if their additives were added to a new battery, such sulfation would be prevented, and if it were added to the electrolyte of a “sulfated” battery, the efficiency of charging would be increased. However, in their instructions

they did recommend that charging be done slowly, and in a series of charge-discharge steps. The central question was, therefore, "Do these additives really help, or can the same results be obtained without them?"

A related issue is the question of "battery mud." During the course of time, some of the active material falls off the electrodes and settles to the bottom of the cell. This is called "shedding" and the sediment is called "battery mud." If this process continues, the mud will eventually impinge on the two electrodes, thus shorting out the cells. Once a cell is shorted out it becomes useless. The proponents of Battery AD-X2 claimed that their additive would prevent battery mud or actually dissolve it.

A number of tests must be carried out to determine if an additive is indeed effective, or if the same results can be produced without it. One of the tests carried out on a battery is for "capacity." The capacity is the total electrical energy delivered by the battery, usually denoted by "ampere-hours," which is the product of the number of amperes and the time over which they are drawn. This product is directly related to the energy delivered, but its measurement is not simple, because the ampere-hours delivered depend upon the rate of discharge. Discharge at a high rate will yield a lower value than discharge at a slow rate. The reason for this is diffusion in the battery plates. All motorists have had the experience of trying to start their car with a weak battery, only to have the starting motor begin to grunt and finally stop. Upon waiting, with another trial the motor will again turn over, but for a shorter time. What has happened is that in the initial attempt to start the car, the electrolyte in the active material is used up, but there is still active material on the plates. Upon waiting, more electrolyte diffuses into the paste, and the battery will deliver energy again, but for a shorter time. This is the phenomenon that was usually the basis for saying that additives would "charge" batteries. The demonstration of this phenomenon will obviously depend upon the degree of sulfation. If the process is continued for a battery in a low state of charge, all the active material in the plates will be essentially used up, and the battery is effectively dead, although it may be charged again.

A related question is that of charging efficiency, which is the ratio of the ampere-hours delivered by the battery to the ampere-hours used in charging it. Again, this ratio depends on the rates of both charge and discharge. Most important, when comparing experiments with and without additives, the twelve batteries that are used must be in exactly the same condition. Since this is rarely possible, large numbers of batteries must be used for the two experiments, and then the problem becomes one of statistics in comparing the results.

Other, somewhat less important, questions that need to be investigated are the temperature rise on charging, the amount of water lost in the process, and the amount of sediment produced. All of these various factors played a role in determining the efficacy of additives, and in validating the Bureau's work.

These are all laboratory tests. Another way of assessing the value of battery additives is to carry out field tests. In such tests the additive is added to batteries in service and the results assessed. As in laboratory tests, comparison should be made with comparable batteries which have not received an additive but have otherwise received the same treatment (i.e., "controls"). But, and equally important, the batteries being compared should be used under the same service conditions, which is very hard to manage,

and is expensive. The ordinary testimonial is not based on these two crucial comparison factors, hence is scientifically invalid as a test of battery additives. The Bureau conducted no field tests; its results were based entirely on laboratory tests. The proponents of AD-X2 on, the other hand, relied almost exclusively on testimonials, although some tests (of little validity) were carried out on their behalf.

### THE INCIDENT BEGINS

In 1948, the Electrochemistry Section under George W. Vinal was busily at work carrying out research for the military on a whole range of battery problems. On April 23, Vinal received a letter from Merle Randall, professor emeritus of chemistry of the University of California and a consultant in Berkeley. The letter merited attention due to Randall's reputation. He had cooperated with G. N. Lewis on the definitive text, *Thermodynamics and the Free Energy of Chemical Substances* in 1923. He had authored a text on physical chemistry, was well known for his research work, and had taught many distinguished students. Some of his recent work was on electrolytic theory. He wrote on the subject of "Protecto-Charge."<sup>30</sup> The letter reads in part:

One of my clients has purchased the equities in a patent application (Donald E. Kiefer) covering "Protecto-Charge," an addition agent for storage batteries. Frankly, both his patent attorney . . . and I were suspicious of the claims made for this product.

The "Protecto-Charge" process involves the addition of a powder mixture of anhydrous sodium sulfate and a slightly basic, nearly anhydrous, magnesium sulfate to the water while it is filled with standard sulfuric acid electrolyte. Curiously the result is quite different from that when equivalent amounts of sodium sulfate and Epsom salts are added. The active material remains "tight" to the grid and there is so little "shedding" of the active material that there is an apparent, possibly real, decrease in the amount of battery mud.

The letter goes on to point out a large number of satisfied users, all commercial. It also encloses an advertising brochure with the following claims:

1. Reduces harmful effects of "sulfation."
2. Ordinarily increases the capacity of mechanically sound "sulfated" batteries.
3. Helps prevent freezing.

---

<sup>30</sup> Letter, M. Randall to G. W. Vinal, April 23, 1948. (NARA; RG 167; Astin file; Box 10; Folder AD-X2 1948, Randall-Vinal). This is the name by which AD-X2 was originally known. It was changed to Battery AD-X2 in June 1948 because of a trademark problem with the Atlas Distributing Company. The AD in the name stood for "additive," the X for some unknown ingredient or agent, and the 2 for the main two constituents. (J. M. Ritchie testimony, AD-X2 Hearings: 71). The name is usually abbreviated to simply "AD-X2" and this is the custom that will be followed here. In the text the original name will be used until relating events occurring after the name change.

4. Restores to active service, approximately 70 percent of discarded "sulfated" batteries.
5. Lessens the chance of buckled plates and slowly decreases battery mud.
6. Remember, "PROTECTO-CHARGE" will restore your DEAD battery, providing there is no mechanical defect.<sup>31</sup>

The brochure goes on to describe rather sensibly and accurately the various causes of battery failure, and sulfation and its effects. It describes how to treat a run-down battery, and this description is valuable whether "Protecto-Charge" is used or not. It was obviously written by someone who knew about lead-acid batteries. The claims had, in fact, been approved by Randall. "I believe they are conservative," he wrote. Compared to claims made for other additives, these were in fact mild. Vinal, having heard the same thing many times, and because of the press of other work, put the letter aside despite its distinguished author.

The client Randall mentions at the beginning of his letter was an Oakland, California, company called Pioneers, Incorporated. Its president was Jess M. Ritchie, the main protagonist in the AD-X2 incident. He was an aggressive and charismatic entrepreneur with a varied background.<sup>32</sup> Born in Arkansas in 1909, he was a self-educated engineer, having supplemented his sixth-grade education with correspondence courses. He worked as a certified bulldozer operator and a journeyman diesel engineer. After the end of World War II he served as a general superintendent of construction with headquarters in the Philippines for the Drake-Utah-Grove construction combine. "I am basically a bulldozer operator," he said of himself. "I was having trouble with batteries in the Philippines. I came back to Oakland, California, with an idea of doing something about it," he testified before the Senate.

When I came back from the islands, I had never heard about a battery dope in my life. I had never heard anything about it. And I ran into this fellow [Donald E. Kiefer] on East 14th Street and bought a half interest in the business. And what I bought there was a tremendous amount of trouble.

Business was poor, and the additive was harmful to batteries, but feeling he could develop a good product, he bought out his partner. He "ran into Merle Randall" and, after checking at the University of California and the Stanford Research Institute, hired him as a consultant. Together they began experimenting and ran more than 1600 experiments. Then occurred a serendipitous accident in which an experimental batch was "left . . . in process by accident, and when it came out it looked something like melted glass, and I wanted to throw it away. Well, Dr. Randall insisted on using it. So we used it."<sup>33</sup> Thus was Protecto-Charge born, according to Ritchie. His testimony is

<sup>31</sup> Pioneers, Inc., "6 Reasons Why You Should Use Battery 'Protecto-Charge,'" edited and approved by Dr. Merle Randall, 1946. (NARA; RG 167; Astin file; Box 10; Folder AD-X2 1948, Randall-Vinal)

<sup>32</sup> Samuel A. Lawrence, *The Battery Additive Controversy* (University of Alabama Press, 1962); J. M. Ritchie testimony, AD-X2 Hearings: 11-209.

<sup>33</sup> J. M. Ritchie testimony, AD-X2 Hearings: 17-20.

unclear about whether anything other than sodium and magnesium sulfates was used, but he was later to imply that something was. Subsequent chemical analysis by the Bureau indicated that the material did not contain anything but sodium and magnesium sulfates, with other elements at the impurity level.

Ritchie marketed his new product solely to commercial and industrial users. Sales began to pick up and by 1948 they were quite brisk. He decided not to patent the discovery, preferring to keep his process and formulation secret. However, the brochure for Protecto-Charge states "Patent Pending."

Ritchie did not know about LC 302 or the NBBB publication *Facts About Battery Dopes*, but he quickly learned about them. He recalled:

So I got going, and while I was talking to a fellow one day he said, "Have you seen Letter Circular 302?"

I said, "No; what is Letter Circular 302?"

"Well," he said, "something that was put out by the Bureau of Standards some years ago. A battery salesman was out yesterday and showed it to me."

I said Dr. Randall had mentioned that he had found it in the literature, but it was 1931, and I didn't pay too much attention to him.

Now *Facts About Battery Dopes* was a rehash of Letter Circular 302. . . .

Dr. Randall was concerned. I wasn't. We are talking about a document way back there in ancient history.<sup>34</sup>

#### THE INCIDENT DEVELOPS

Ritchie, in fact, became deeply concerned. He began a strategy to have the Bureau make an exception for his product. Irritated that the Bureau had not tested it and had lumped it for condemnation with all other additives, his main purpose was to have the Bureau test it, probably sincerely believing that the Bureau would find that it indeed had merit. He began a three-pronged effort: (1) with Randall corresponding with the Bureau, (2) using the Oakland Better Business Bureau, of which he was a member and with which he had friendly relations, and (3) on the political front.

Thus, when Vinal did not reply to his letter of April 23, 1948, Randall wrote again on June 25. He enclosed a test which he considered severe. He had developed it for battery additives and told about favorable results (on a single battery) with Protecto-Charge as compared to Epsom and Glauber's salts. Hereafter this test will be referred to as the "Randall Test."<sup>35</sup>

This time Vinal replied at some length. He repeated the Bureau's experience with additives of sodium and magnesium sulfates, and how, once in solution, there can be no difference between Epsom and Glauber's salts and their anhydrous variations. He told of new, unpublished experiments that confirmed this experience. He enclosed a copy of LC 302 with the statement, "I have no reason to change the statements contained in this pamphlet."<sup>36</sup> Correspondence continued throughout the year,

<sup>34</sup> J. M. Ritchie testimony, AD-X2 Hearings: 19.

<sup>35</sup> Letter, M. Randall to G. W. Vinal, June 25, 1948. (NARA; RG 167; Astin file; Box 10; Folder AD-X2 1948, Randall-Vinal)

<sup>36</sup> Letter G. W. Vinal to M. Randall, July 1, 1948. (NARA; RG 167; Astin file; Box 3; Folder AD-X2 (2))



becoming rather testy toward the end, by which time both men had tacitly agreed to disagree.<sup>37</sup>

Pressure on Vinal also came from the Oakland Better Business Bureau (OBBB). In fact, the general manager of the OBBB had been in correspondence with Ritchie. "The Better Business Bureau of Metropolitan Oakland has never received complaints of any nature concerning your company," Jack A. Harris wrote to Ritchie on November 26, 1948. The letter continues:

Information received . . . from the Bureau of Standards indicates that the Bureau of Standards has not tested your product and have [sic] categorically classified it as a battery dope. At the present time, we are endeavoring to obtain from the Bureau of Standards a full report on your product, . . . [W]e are sending the Bureau of Standards a sample of your product that they may make the necessary examination.<sup>38</sup>

Thus, on December 1, 1948, Harris wrote to Vinal asking that a sample of AD-X2 be tested so that, "it will be possible for us to have the expert opinion of the Bureau of Standards and that we may then determine whether or not this product can justly be sold as a non-harmful product to aid in lengthening the life of storage batteries."<sup>39</sup> Vinal was caught. He could not agree to test the product or identify it in Bureau publications without going against long-standing Bureau policies. In his reply he stated that the reason the Bureau did not test AD-X2 was its long experience with additives consisting of sodium and magnesium sulfates and, according to Randall, this was the composition of the product. Moreover, three competent military laboratories were now testing it, and "in view of the above fact it does not seem desirable for a fourth Government agency . . . to spend the time urgently needed for Army and Navy work to make further tests of these materials." He then quoted the Bureau policy on tests, "This Bureau does not make commercial tests of batteries or battery materials and it is an established policy of the Bureau not to endorse commercial products or to permit the results of its tests to be used for advertising purposes."<sup>40</sup>

On the political front, Ritchie appealed to Senator William Knowland, a resident of Oakland. He wrote a long letter to the Senator on December 3, 1948, asking "the Senator for his assistance as regards the attitude of the National Bureau of Standards to our product AD-X2 . . ." Giving a short history and description of his product, pointing out his many satisfied users, and stating that the Bureau had not tested it, he

<sup>37</sup> Letter, E. U. Condon to M. Randall, September 12, 1949, in belated response to a letter of Randall to Condon, January 10, 1949. (NARA; RG 167; Astin file; Box 10; Folder AD-X2 1949)

<sup>38</sup> Letter, J. A. Harris to J. W. Ritchie, November 26, 1948. (NARA; RG 167; Astin file; Box 3; Folder AD-X2 (2))

<sup>39</sup> Letter, J. A. Harris to G. W. Vinal, December 1, 1948. (NARA; RG 167; Astin file; Box 3; Folder AD-X2 (2))

<sup>40</sup> Letter, G. W. Vinal to J. A. Harris, December 22, 1948. (NARA; RG 167; Astin file; Box 3; Folder AD-X2 (2))



California Senator William F. Knowland from Oakland wrote to NBS Director Condon on December 9, 1948, requesting that the Bureau test AD-X2. Knowland's letter on behalf of his constituent prompted the Bureau to make tests on the additive. First intended to be kept confidential, the test results were disclosed to the National Better Business Bureau, precipitating a major controversy. (AP-Wide World Photos)

wrote, "until such time as they check our claims we feel that our product is being condemned without the benefit of trial, and has been for the past year and a half."<sup>41</sup>

On December 9, Knowland wrote a short letter to Condon enclosing the file Ritchie had sent him. The letter closes:

I, of course, have no personal knowledge of the claims made for this particular product. However, reputable people are associated with the firm and well known business organizations have been making use of their product. If in line with the policy of the Bureau of Standards it would be appreciated if such a test could be made so that this product could stand on its own merits.<sup>42</sup>

Condon, in turn, wrote to Knowland on December 20. After a short account of the Bureau's involvement with battery additives and AD-X2, he wrote, "In view of Dr. Randall's statement it is obvious that "AD-X2" does not differ significantly from

<sup>41</sup> Letter, J. M. Ritchie to Senator W. F. Knowland, December 3, 1948. (NARA; RG 167; Astin file; Box 10; Folder Senator Knowland)

<sup>42</sup> Letter, Senator W. F. Knowland to E. U. Condon, December 9, 1948. (NARA; RG 167; Astin file; Box 10; Folder Senator Knowland)

other materials tested. Hence it does not seem desirable for this Bureau to go into the matter further."<sup>43</sup> Condon had refused to test AD-X2. And, of course, he was essentially constrained not to test it by Bureau policy. Knowland's letter, however, lay there like an unsatisfied demand, and was to prove instrumental in causing the Bureau to test AD-X2.

Condon's letter to Knowland was sent on to Ritchie, and Randall tartly wrote to Condon about it:

The objections properly raised by Dr. Vinal in Circular 302 with respect to the battery additives previously tested at the Bureau do not apply to "AD-X2," which should be specifically exempted from those implications. . . . The reputation of the National Bureau of Standards is too precious to be dulled by an attitude based on preconceived notions . . . I wish to assure you that I too, value my reputation, and that if I had found anything to point to false claims by Pioneers, Inc., that I would not continue as a Consultant for them.<sup>44</sup>

The nature of the controversy was becoming clear.

#### THE NATIONAL BETTER BUSINESS BUREAU

As already mentioned, the Bureau was in correspondence with the National Better Business Bureau (NBBB) from the earliest days of its additive testing and since the NBBB publication of *Facts About Battery Dopes*. Now the NBBB became concerned about that publication. It was, after all, a document based on the Bureau's LC 302, which dated from 1931. Since that date many new additives had come on the market, and the postwar years had seen a veritable explosion of them. The Bureau itself had tested 26 between 1931 and the end of 1947. A full 18 of these were tested after 1940, when *Facts About Battery Dopes* was published. The NBBB began to wonder if LC 302 should be brought up to date. Thus, quite independently of the AD-X2 matter, Kenneth B. Willson, Operations Manager of the NBBB, wrote to Vinal about this on June 10, 1948. Vinal replied on June 25 before he had replied to Randall's initial letter. Perhaps with "Protecto-Charge" in mind, he wrote, "This is in reply to your letter . . . regarding battery compounds which seem to be becoming increasingly numerous and troublesome." He then wrote that at the present time he saw no reason to change the statements in LC 302, but that he "had it in mind for some time that we should issue a new letter circular to supersede the present 302, and . . . incorporate some of the data more recently obtained. . . . I shall be glad to have your opinion as to the desirability of issuing an up-to-date statement of the problem."<sup>45</sup> Vinal's request for the advice of the NBBB was unfortunate, for it made it seem that the Bureau was in some sense an agent of a private institution.

<sup>43</sup> Letter, E. U. Condon to Senator W. F. Knowland, December 20, 1948. (NARA; RG 167; Astin file; Box 10; Folder Senator Knowland)

<sup>44</sup> Letter, M. Randall to E. U. Condon, January 10, 1949. (NARA; RG 167; Astin file; Box 10; Folder AD-X2 1948, Randall-Vinal)

<sup>45</sup> Letter, G. W. Vinal to K. B. Willson, June 25, 1948. (NARA; RG 167; Astin file; Box 3; Folder AD-X2 (2))

Vinal did prepare a revision of LC 302 in the fall of 1948, but in the process of pre-publication review, Bureau management decided that a completely new document was required. But the NBBB was anxious to revise its own pamphlet, and in lieu of a new report, the Bureau provided the NBBB with a statement from Director Condon. This statement reiterated the Bureau's position that battery additives were without merit, and specifically singled out Epsom and Glauber's salts—and "analogous materials"—for mention. The statement concluded with the paragraph:

It is still evident that the best electrolyte for a storage battery is that presently used by the battery manufacturers since years of research and experience have shown no other materials superior to the customary sulfuric acid electrolyte of proper specific gravity.<sup>46</sup>

The NBBB used this statement to prepare its own publication, and issued a Service Bulletin, *Battery Compounds and Solutions*, published on March 16, 1949. Along with the Condon statement, this bulletin warns that manufacturers' guarantees are voided by the introduction of "battery dope" into their batteries. It was clear that the NBBB had split from the OBBB, which insisted that the Bureau test AD-X2.

### THE MILITARY TESTS

While all these activities were going on, there was action in another area. The military, inheritors of thousands of war-surplus batteries, most in poor condition, was looking at ways to save them. Beginning as early as 1947, they began testing AD-X2, still called "Protecto-Charge." There were a total of eleven installations, but the main tests were carried out at six locations: The Squire Signal Corps Laboratory at Fort Monmouth, New Jersey; the New York Navy Shipyard; the Mare Island Navy Yard; the Detroit Arsenal; Benicia Arsenal, Benicia, California; and the Aberdeen Proving Grounds in Maryland. Two of these—Benicia and Aberdeen—returned positive results, while the others were negative. Vinal criticized the tests with positive results, as did the military itself for the Benicia results, stating, "Of course, they do not say the same batteries would have worked equally well had they been given a slow charge without the use of any compound."<sup>47</sup> Perhaps influenced by negative results with all other additives, the military stopped purchases and testing of AD-X2. This left some unhappy battery technicians in the service, for they believed in the product.

---

<sup>46</sup> Letter, E. U. Condon to K. B. Willson, March 9, 1949. "Statement About Battery Compounds and Solutions" is attached. (NARA; RG 167; Astin file; Box 3; Folder AD-X2 (2))

<sup>47</sup> Memorandum, G. W. Vinal to E. U. Condon, January 17, 1949; letter, G. W. Vinal to K. B. Willson, June 10, 1949. (NARA; RG 167; Astin file; Box 10; Folder AD-X2 1948, Randall-Vinal)

## THE BUREAU TESTS AD-X2 AND THE PACE QUICKENS

By early 1949, the outlines of the controversy and the positions of the contestants were essentially laid out. The Bureau was adamant that all battery additives based on sodium and magnesium sulfates were worthless, though not necessarily harmful. Led by Randall, Pioneers was equally adamant that AD-X2 was a valuable and useful product. The OBBB, based on the fact that there were no complaints about AD-X2, was solidly behind Pioneers. The NBBB was solidly behind the Bureau, and used its results in its own publications, but they were nervous because it—and all the other contestants—believed the Bureau had not tested AD-X2.

The Bureau had, in fact, tested it. In January 1949, having tests to run for the FTC on another—but unrelated—additive, Vinal included AD-X2 in the tests because this could be done with little extra effort. The tests were done at his initiative and for his own edification, but Senator Knowland's letter was an added stimulus.<sup>48</sup> Using the samples of material furnished by the OBBB, AD-X2 was tested on two batteries, a new one and an old one.<sup>49</sup> Vinal found no reason to change his position. He did not, of course, publish these results or make them known to anyone outside the Bureau since this would involve identification of a proprietary product which was against Bureau policy. In fact, in June 1949, Vinal was still not admitting to having tested AD-X2. On June 17, Willson of the NBBB wrote to Vinal asking him to test AD-X2, and on June 22 Vinal replied, "It has been our policy not to make any tests on commercial products until requested to do so by some Government agency which is interested in the merits of the product. If this matter is turned over to FTC it is possible we may be requested to make tests."<sup>50</sup> This last phrase was subsequently interpreted to be a subtle attempt by the Bureau to have the FTC investigate Pioneers.

During 1949, Randall shifted his letter writing from Vinal to Condon, and became more assertive. In a series of letters through the whole of 1949, he extolled the virtues of AD-X2, repeated the field experience of numerous satisfied users, attacked the negative military results, and repeated his own successful experiments. Condon answered all the letters, his replies undoubtedly written by Vinal, pointing out that the field experience was flawed in that it did not show that the same results could have been achieved by a similar treatment without the additive, and also pointing out flaws in Randall's experiments and logical fallacies in his conclusions. Condon and Randall also tacitly agreed to disagree.

Now a new and significant player—the Federal Trade Commission—entered the fray. The NBBB, armed with the Condon statement which they had published in their Bulletin, lodged a complaint with the FTC, asking it to investigate Pioneers for false advertising claims. Thereupon the FTC ordered its San Francisco office to look into the situation.

---

<sup>48</sup> A. V. Astin testimony, AD-X2 Hearings: 314.

<sup>49</sup> Lawrence, *Battery Additive Controversy*, p. 7.

<sup>50</sup> Letter, G. W. Vinal to K. B. Willson, June 22, 1949. (NARA; RG 167; Astin file; Box 3; Folder NBBB and Memo Sent to SSBC)

The investigators were nonplussed. They found that AD-X2 had many satisfied customers in the Bay area—including some personnel at military installations—and was highly regarded. The OBBB was strongly supportive of AD-X2, and in fact Harris of the OBBB wrote to Willson of the NBBB on August 30, 1949:

Here, Ken, is the issue as I see it. In my opinion neither you nor the National Better Business Bureau nor any other organization on God's green earth have the right to participate in preventing a man from carrying on free enterprise by direct or indirect means unless there is a reasonable basis for such an action.<sup>51</sup>

In view of this situation, the San Francisco FTC office recommended to Washington in February 1950 that they have the Bureau test AD-X2.

In the meantime, Ritchie expanded his operations. He appointed dealers in various cities on the West Coast. Those dealers not only sold his product, but reconditioned old batteries and sold them at highly reduced prices with a one-year guarantee. This was of deep concern to battery manufacturers, and one of them, Keystone Batteries of San Francisco, expressed this concern to the American Association of Battery Manufacturers in a letter on February 2, 1950.<sup>52</sup> Enclosing a copy of the Keystone letter, that organization then wrote to the FTC on March 10, "We believe the FTC should take some action in regard to the enclosed complaint in the interest of both battery manufacturers and battery consumers. Before doing so a careful analysis of this material should be made. . . ."<sup>53</sup>

As a result of these two requests, on March 22, 1950, the FTC asked the Bureau to test AD-X2. The Bureau was asked to determine if six advertising claims "may properly be made" for the product.<sup>54</sup> On May 11, 1950, the Bureau reported that a series of tests had failed to demonstrate any reduction in harmful sulfation.<sup>55</sup> But events would conspire to force the Bureau to go public with its results even before it reported to the FTC.

#### THE BUREAU GOES PUBLIC ON AD-X2

After the issuance of the NBBB Bulletin *Battery Compounds and Solutions* containing the Condon statement, Ritchie's promotional literature claimed that statements made by the Bureau and the NBBB did not apply to AD-X2 because the Bureau had not tested it. As a result, the NBBB was swamped with requests for clarification. This

---

<sup>51</sup> Letter, J. A. Harris to K. B. Willson, August 30, 1949. (AD-X2 Hearings: 78-79)

<sup>52</sup> Letter, W. Brizee, Secretary, Keystone Batteries, to V. L. Smithers, Commissioner, The Association of American Battery Manufacturers, February 2, 1950. (AD-X2 Hearings: 514-515)

<sup>53</sup> Letter, V. L. Smithers, Commissioner, The Association of American Battery Manufacturers, to the Federal Trade Commission, March 10, 1950. (AD-X2 Hearings: 515)

<sup>54</sup> Letter, I. Burton, Acting Chief Examiner, Federal Trade Commission, to National Bureau of Standards, March 22, 1950.

<sup>55</sup> National Bureau of Standards, "Report of Test of 'AD-X2' Battery Material Submitted by Federal Trade Commission," George W. Vinal, Chief, Electrochemistry Section, May 11, 1950,

was bothersome enough, but the issue became more serious. On March 29, 1950, Willson of the NBBB wrote to Vinal:

[W]e have considered sending a bulletin to battery manufacturers . . . because Pioneers, Inc., apparently has been pursuing a deliberate course of making inquiry of various manufacturers and their dealers in regard to the product—AD-X2. When they receive in reply a copy of our bulletin . . . they believe they have evidence to show that through the distribution of our bulletin we and the manufacturers distributing it are damaging their business. I do not know what they intend to do with this “evidence,” but in view of certain threats which they have made about possible action against the manufacturers, we felt dutybound to put them on notice.

However, Dr. Vinal, there would be no need for us to issue any statement to battery manufacturers, or to anyone else, on this subject if you would permit us to inform Pioneers, Inc., that you have now concluded a comprehensive test of AD-X2, and that you found that AD-X2 is not effective and therefore does not serve a useful purpose. . . . If we now can tell Pioneers, Inc., that you have tested their product and found it wanting, they may continue to dispute your findings and conclusions but they cannot claim that they are based upon theory and not an intimate knowledge of the product.<sup>56</sup>

At the time Vinal received this letter, he had the results of the tests carried out on his own initiative in January 1949, but he had gone further. Approximately six months before, he had begun a series of tests designed to provide information for the revision of LC 302. For this purpose he had chosen five used batteries which were badly sulfated. Two of these were treated with commercial additives—one of them AD-X2—and the remainder with laboratory-prepared mixtures of sodium and magnesium sulfates of differing compositions. One cell of each battery was used as a control, i.e., had no additive added. He also had a chemical analysis of AD-X2 carried out as part of the FTC tests. These showed that the material was 46.6 percent magnesium sulfate and 42.9 percent sodium sulfate, with the remainder water of hydration. Further analysis showed that the sodium sulfate was anhydrous, and that the water was attached to the magnesium sulfate, so that its composition was approximately  $\text{MgSO}_4 \cdot 1.2\text{H}_2\text{O}$ .<sup>57</sup> Armed with the results of these tests, on April 5, 1950, Vinal replied to Willson as follows:

After talking the matter over with administrative officials and several of our Technical staff, I think it appropriate for you to transmit the following statement to Pioneers, Inc., if you wish to do so.

<sup>56</sup> Letter, K. B. Willson to G. W. Vinal, March 29, 1950. (NARA; RG 167; Astin file; Box 3; Folder AD-X2 (2)) Lawrence, *Battery Additive Controversy*, p. 9, states that Willson wrote to Vinal that he was afraid Pioneers would sue. There is no mention of a suit in this letter, although there is an implication of a possible one.

<sup>57</sup> National Bureau of Standards, “Report on Examination of Battery Additives Submitted by Federal Trade Commission thru Division 1, Section 8,” James I. Hoffman, Chief, Surface Chemistry Section, April 13, 1950.

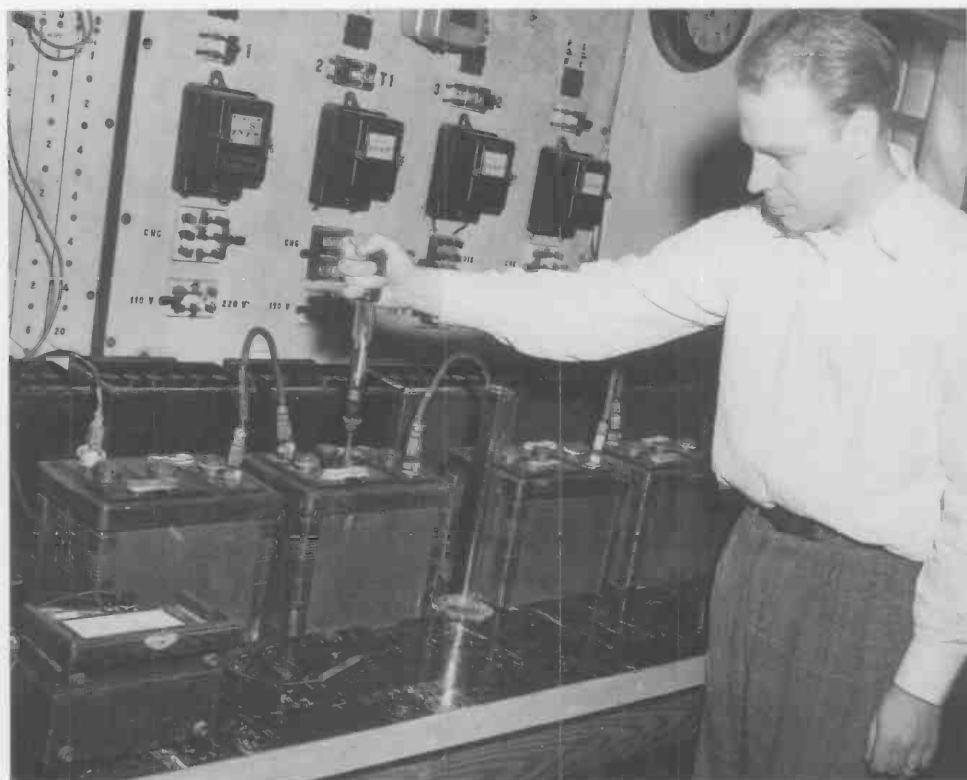

Automotive (front row) and aircraft (back row) batteries were studied by NBS to determine the effect of magnesium and sodium sulfate additives on their performance and useful life. In this photograph, Herbert J. Reed of the Electrochemistry Section measured specific gravity. The measurements showed no significant difference between treated and untreated cells. The results of these experiments were the basis for the Bureau's Circular 504, *Battery Additives*, by Paul L. Howard and George W. Vinal.

At your request for information relative to this Bureau's work on battery additives and on one known as AD-X2 in particular, it may be stated that the Bureau, for its own information, has made extended experiments recently, the results of which confirm our previous conclusions that magnesium sulfate and sodium sulfate are not effective as alleged in restoring storage batteries or in prolonging their life. On the basis of these recent experiments we have no reason to modify statements previously made in our Letter Circular 302.

These experiments were initiated to obtain data on several battery additives at present being sold to the public as well as on a wide range of compositions which the Bureau prepared. AD-X2 was therefore included in these tests. The samples of AD-X2 used in these tests were received from the Better Business Bureau of Oakland, Calif. In the preparation of the report the battery additives actually used are designated in code. The Bureau was fortunate in procuring a group of batteries in sound mechanical condition but



sulfated as a result of long standing. Tests of these extended over six months and it is now possible to say that the results show no benefit from the use of these additives, including AD-X2.<sup>58</sup>

Ritchie had achieved his goal of having the Bureau test his product, but the results were not those he had hoped for. His battle with the Bureau would have to move to another arena.

And Ritchie's problems would soon increase. The NBBB was not satisfied merely to transmit the Bureau's results to Pioneers; it wanted to make them public. Accordingly, it prepared a statement based on Vinal's letter to be issued along with its Bulletin *Battery Compounds and Solutions*. By letter from Willson to Vinal on July 19, 1950, it requested permission to use the statement. The Bureau, its position evidently hardening, went against its long-standing policy in a letter from Condon to Willson on July 24, 1950, and authorized use of the statement in the NBBB Bulletin.<sup>59</sup> The Bulletin was published in August 1950.<sup>60</sup> The key paragraph from the Bureau's statement reads:

In view of the tests made here and in competent laboratories elsewhere it is our belief that AD-X2 is not essentially different from other preparations containing magnesium sulfate and sodium sulfate, and that as a class these materials are not beneficial. The results of recent tests are being prepared for issuance as a Bureau circular but in the meantime we see no reason to modify Letter Circular 302.

The statement also makes clear that the Bureau had tested AD-X2:

These experiments were initiated to obtain data on several battery additives at present being sold to the public as well as on a wide range of compositions which the Bureau prepared. AD-X2 was therefore included in these tests.

A paragraph on work done elsewhere reads:

We have also the results of tests made elsewhere on 200 batteries in actual service on automobiles which were treated with AD-X2. A sufficient number of cells in these batteries were kept in the untreated condition for comparison with the results of those treated. Here again the results show no evidence of beneficial effects of AD-X2.

The NBBB did allow Pioneers to make a dissenting statement. It was short:

In the correspondence between us it has been mentioned many times by both Dr. Randall and ourselves that it is difficult to make a really definitive

<sup>58</sup> Letter, G. W. Vinal to K. B. Willson, April 5, 1950. (NARA; RG 167; Astin file; Box 3; Folder AD-X2 (2))

<sup>59</sup> Letters, K. B. Willson to G. W. Vinal, July 19, 1950; E. U. Condon to K. B. Willson, July 24, 1950. (NARA; RG 167; Astin file; Box 3; Folder AD-X2 (2))

<sup>60</sup> National Better Business Bureau, "Battery Compounds and Solutions," August 1950.

laboratory test of Battery AD-X2 and that the only practical means of determining the value of the product is through field test.<sup>61</sup>

As to the field test by the National Bureau of Standards we note that they have definitely stated . . . that such a test or tests was made on batteries in actual service. We are well aware of this but . . . these tests were not run in accordance with our specifications and therefore did not indicate the value to be derived from our product.

The field tests referred to in the statement were not, in fact, the Bureau's tests but were carried out by the Ordnance Department of the Army. However, Ritchie's statement that these tests were not carried out "in accordance with [his] specifications" would be his rallying cry for the remainder of the incident.

The NBBB distributed 50 000 copies of the Bulletin.<sup>62</sup> Its publication and distribution had a totally unanticipated effect. *Newsweek*, sensing a dispute and quoting the experience of many satisfied users, published an article highly favorable to AD-X2. Other articles favorable to AD-X2 appeared in *American City*, *Western Construction News*, *Western Industry*, and *Batterymen*.<sup>63</sup> It seemed as if a mighty Government agency was beating up on a small, helpless manufacturer. Ritchie's sales soared.

This did not last long. Vinal had been working on the revision of LC 302, and on January 10, 1951, the Bureau published Circular 504, *Battery Additives*, a definitive statement of the Bureau's results—the same five tests it had used to allow the NBBB to identify AD-X2. In this publication, the additives were coded so that the Bureau did not name AD-X2.<sup>64</sup> But the circular went beyond the laboratory results. It quoted the field tests carried out by the Army Ordnance Corps on 200 batteries in various conditions, including 100 new ones, half treated and half untreated. Both laboratory and field tests clearly showed that AD-X2 had no beneficial effect. As a result, the circular concluded, "there has been no improvement found in the use of a series of commercial and specially prepared additives composed of magnesium and sodium sulfates either hydrated, partially hydrated or anhydrous." In its new definitive publication, the Bureau upheld the conclusions of its old LC 302. The wording here is important. The Bureau did not find that AD-X2 and its analogues were harmful; it merely found that it provided no improvement. Would another set of different tests demonstrate improvement? A definitive "no" cannot be given as answer. A negative is difficult to prove.

---

<sup>61</sup> It is interesting to note that during the development of AD-X2, Ritchie and Randall relied only on laboratory tests to determine the value of their product.

<sup>62</sup> Letter, K. B. Willson to Paul L. Howard (Vinal's assistant), October 31, 1950. (NARA; RG 167; Astin file; Box 3; Folder AD-X2 (2))

<sup>63</sup> J. M. Ritchie testimony. AD-X2 Hearings: 24. Some of these articles may have been stimulated by Ritchie.

<sup>64</sup> It should be noted that the Bureau never identified AD-X2 in its own publications until April 1953 in *Report on Battery Additives by the National Bureau of Standards*, National Bureau of Standards Report 2447. This report was administratively restricted. It did permit the NBBB to identify AD-X2 in August 1951, but any interested reader can easily deduce that AD-X2 was "mixture C" in the tests prior to this time.

Circular 504 was followed by three publications designed to advertise its findings. A Commerce Department press release came shortly after its publication. This was followed in April 1951 by Technical Report 1537, which went to the technical and trade press, and was suitable as a basis for a technical article. And in May, an article describing the results and conclusions appeared in the Bureau's *Technical News Bulletin*. Ritchie called it "a perpetual news release."<sup>65</sup>

These publications had a drastic effect on Ritchie's business. His sales fell from a high of \$75 000 in the first quarter of 1951 to \$40 000 in the final quarter, and continued to decrease.<sup>66</sup> He encountered difficulties in getting his side of the story in the press and, under pressure of battery manufacturers, the press was loath to accept his advertising.

Up to this time Ritchie had had little personal contact with the Bureau, leaving this to Randall. But Randall died on March 19, 1950, and a year later Ritchie—three months after the publication of Circular 504—was still trying to get the Bureau to make an exception for his product on the basis that the Bureau had not tested it, somehow still believing that the Bureau had not tested AD-X2. On May 29, 1951, and again on June 29, 1951, he wrote to the Bureau asking, "Has the National Bureau of Standards ever tested Battery AD-X2. . . ." Since George Vinal retired on June 30, 1950, replies came from Walter J. Hamer, who had succeeded Vinal as chief of the Electrochemistry Section. He wrote:

I felt that you were aware of our tests in view of the Bulletin of the National Better Business Bureau, and was somewhat puzzled by your question. . . .

I find that the statements appearing in the issue of August 1950 of the National Better Business Bureau had the approval of our administrative officials. Your correspondence to us and to them requesting that an exception be made publicly to "Battery AD-X2" on the grounds that the National Bureau of Standards had not tested this material had a bearing on this decision.<sup>67</sup>

Ritchie would not get the Bureau to change its position. This fight would have to be taken to yet another arena.

---

<sup>65</sup> Lawrence, *Battery Additive Controversy*: 10; U.S. Department of Commerce, National Bureau of Standards. "Battery Additives," Press release TRG-6116; U.S. Department of Commerce, National Bureau of Standards. "Battery Additives," Technical Report 1537, April 1951; "An Investigation of Battery Additives," *Technical News Bulletin* 35, no. 5 (May 1951): 63-65.

<sup>66</sup> Lawrence, *Battery Additive Controversy*: 10.

<sup>67</sup> Letters, J. M. Ritchie to W. J. Hamer, May 29, 1951; W. J. Hamer to J. M. Ritchie, June 5, 1951; J. M. Ritchie to W. J. Hamer, June 29, 1951; W. J. Hamer to J. M. Ritchie, July 9, 1951. (NARA; RG 167; Astin file; Box 3; Folder AD-X2 (3))

## RITCHIE GOES POLITICAL

Having developed a national network of "distributors, prospective distributors and interested parties," Ritchie used that network to bring political pressure on the Bureau. He wrote to them on August 21, 1951, of his intentions to bring about a Senate investigation of the Bureau. "The way we got action," he testified, "was the distributors wrote to the Senators, the Senators wrote to the Bureau of Standards, the Bureau of Standards wrote back to the Senators, and the Senators sent it back to their constituent, who was our distributor, and they sent it to us, and we could see how they were thinking. That is the way 24 Senators got tangled up in it."<sup>68</sup> There were, in fact, twenty-eight senators and one congressman who wrote to the Bureau between July and December 1951, some more than once, so that there was a total of forty congressional letters. In addition, many of the distributors wrote directly to the Bureau with requests that an exception be made for AD-X2. The Bureau technical staff, already overloaded with more battery testing, were kept so busy answering the congressional and other letters that they wrote a document, "Memorandum on Battery Additives,"<sup>69</sup> to be sent in response to inquiries. This memorandum "gives the position and policy of this Bureau on the testing of additives and gives some pertinent facts on the use of additives in storage batteries."<sup>70</sup>

The senators' letters enclosed letters from their constituents, and ran to a pattern, described by the Bureau in a letter to Senator Herbert H. Lehman on August 31, 1951:

During the past months 20 other Senators and one Congressman have been contacted by the distributors of "Battery AD-X2". . . . a consistent pattern is evident in their approach. So far their letters fall into three groups: (1) the first stated that the National Bureau of Standards refused to test their material; (2) the second stated that their material was not field tested at this Bureau and stated or inferred that laboratory tests are insignificant; and (3) the third stated that laboratory tests are after all significant but that the laboratory tests of this Bureau are not. Most distributors or expounders of battery additives claim that their materials are not properly tested. They have made this claim for the past 25 years. However, their recommended methods of test change as each previous one is refuted.<sup>71</sup>

And in another letter to the same senator:

It would appear that those interested in promoting Battery AD-X2 cannot be satisfied unless the National Bureau of Standards specifically exempts Battery AD-X2. . . . This cannot be done (1) because it would be contrary to the conclusive results of the carefully planned and conducted experiments

<sup>68</sup> J. M. Ritchie testimony, AD-X2 Hearings, p. 48.

<sup>69</sup> National Bureau of Standards, "Memorandum on Battery Additives," August 28, 1951.

<sup>70</sup> Letter, E. U. Condon to Senator H. H. Lehman, signed by A. V. Astin, August 31, 1951. (NARA; RG 167; Astin file; Box 3; Folder AD-X2(4))

<sup>71</sup> *Ibid.*

reported in the circular and (2) because it would be contrary to the long-established policy of the National Bureau of Standards, which is to give neither public condemnation nor endorsement to any specific brand-named product.<sup>72</sup>

The letter clearly showed the Bureau's view of the situation, and that the Bureau was not about to budge.

As Ritchie's letter-writing campaign got under way, an important event occurred. On August 10, 1951, while the Bureau was celebrating its fiftieth anniversary, Condon submitted his resignation as director of the Bureau effective September 30. Allen V. Astin, who had been at the Bureau since 1930, was appointed acting director.<sup>73</sup> Astin was recognized for his administrative abilities, and as a distinguished scientist for his work on electrical standards and telemetry before World War II, and particularly for the proximity fuze during the War. He became the Bureau's main protagonist for the remainder of the AD-X2 incident.

### THE POST OFFICE ENTERS THE FRAY, AND THE FEDERAL TRADE COMMISSION TAKES ANOTHER LOOK

While Ritchie's political campaign was moving along well in the Congress, unknown to him serious problems were about to arise for him in the Executive Branch. On September 6, 1951, while Ritchie's senator-writing campaign was in full swing, C. C. Garner, chief inspector of the Post Office Department, wrote to the director of the Bureau in regard to "Alleged violation of Section 130.52, P. L. and R., by Pioneers, Inc., Jess M. Ritchie; sale of battery charger - Eighty [sic] X-2," and enclosing "three envelopes containing . . . AD-X2." The POD was asking the Bureau for another test of AD-X2 to see if it met "all the claims made for it in the literature."<sup>74</sup>

The Bureau submitted a report on December 12, 1951. Its chemical analysis showed the material to be a "mixture of partially hydrated sodium and magnesium sulfates."

The electrical tests were conducted on two batteries, with two cells in each being treated and the remaining cell used as a control. The results were that "Battery AD-X2' . . . has no beneficial effects on the performance of lead-acid batteries."<sup>75</sup>

<sup>72</sup> Letter, A. V. Astin to Senator H. H. Lehman, October 17, 1951. (NARA; RG 167; Astin file; Box 3; Folder AD-X2(4))

<sup>73</sup> A short biography of Astin is in MFP, and a longer one is by Elio Passaglia, *Science: Evidence, Truth & Integrity*. Short biographies of Astin and Condon are also given in Chapter 3.

<sup>74</sup> Letter, C. C. Garner, Chief Post Office Inspector, to NBS director, September 6, 1951. (NARA; RG 167; Astin file; Box 11; Folder P.O. & F.T.C. re AD-X2)

<sup>75</sup> National Bureau of Standards, "Report on Examination of Battery Additive AD-X2 Submitted by Post Office Department thru Division 1, Section 8, Project No. 0199," James I. Hoffman, Chief, Surface Chemistry Section, December 10, 1951; National Bureau of Standards, "Report of Test of 'Battery AD-X2' Battery Additive Submitted by Post Office Department, Case No. 85372-F," Walter J. Hamer, Chief, Electrochemistry Section, December 12, 1951.

In five separate chemical analyses of lots of AD-X2, the chemical composition was quite variable. The Bureau's results for magnesium sulfate, sodium sulfate, and water, respectively, were, in percent, (1) 46.9, 42.9, 10.9; (2) 40.6, 38.9, 20.5; (3) 41.5, 37.2, 21.3; (4) 46.1, 43.0, 10.9; (5) 53.0, 35.8, 11.2. There was only a trace of magnesium oxide, and a number of other elements at the impurity level of composition. Significantly, the trace impurities were the same and of similar concentration as those found in commercial battery electrolyte and technical sulfuric acid.

On March 18, 1952, the POD formulated a complaint against Pioneers alleging that they were engaged in attempting to obtain money "through the United States mails by means of false and fraudulent pretenses. . . ." Ritchie was ordered to appear at a hearing in Washington on April 6, 1952, to discuss its issuance.<sup>76</sup>

But the Bureau's report was ambiguous as to what samples of AD-X2 were used in the tests, and on March 13, 1952, the POD asked for further tests. The hearings for Ritchie were delayed four successive times to await the results. Six discarded and six new batteries were used in these tests and, aware that Ritchie and his supporters had stated that the Bureau had not tested AD-X2 by Pioneer's recommended procedure, the Bureau used the Randall Test. The results were by now predictable: "The electrical tests of 'Battery AD-X2' at this Bureau showed that the product has no beneficial effects on the performance of lead-acid storage batteries." The hearings were scheduled for October 13, 1952.<sup>77</sup>

The FTC also needed new tests. Those performed in early 1950 had not been made on the samples of AD-X2 provided by the FTC, and hence legal traceability was lost. Thus, on February 26, 1952, the FTC asked for further tests. Reported on July 21, 1952, these were not ambiguous, and were by now an old story. Of the material provided, 99.7 percent was water soluble, consisting of 53.0 percent magnesium sulfate, 35.8 percent sodium sulfate, and 11.2 percent water of hydration. The remaining 0.3 percent was water insoluble, consisting mainly of barium sulfate with "traces of several elements which undoubtedly were impurities contained in the basic materials, sodium sulfate and magnesium sulfate." Any scientist looking at the results would say that Battery AD-X2 was a not very carefully prepared mixture of dehydrated Epsom and Glauber's salts. And the electrical tests, again using the Randall procedure, were again unambiguous. They were made on six discarded Exide XH-152 batteries, as usual maintaining one or two cells in each battery as controls. The results were again predictable: "in view of the over-all tests made in this laboratory, the Bureau fails to find evidence that the use of this material would justify the claims made. . . ."<sup>78</sup>

<sup>76</sup> To the Chief Hearing Examiner of the Post Department. "In the Matter of the Complaints That Pioneers . . . are engaged in conducting a scheme for obtaining money through the mails by means of false and fraudulent pretenses, representations and promises . . . March 18, 1952. Roy C. Frank, Solicitor.

<sup>77</sup> Letter, C. C. Garner, Chief Post Office Inspector, to A. V. Astin, March 13, 1952. (NARA; RG 167; Astin file; Box 11; Folder P.O. & F.T.C. re AD-X2); "Standard Test for Additives for Storage Batteries," Merle Randall, May 20, 1948. (NARA; RG 167; Astin file; Box 3; Folder AD-X2 (2)); National Bureau of Standards, "Report on Examination of AD-X2 Battery Additive Submitted by Post Office Department thru Division 1, Section 8, Project No. 0199," James I. Hoffman, Chief, Surface Chemistry Section, July 8, 1952; National Bureau of Standards, "Report of Test of 'Battery AD-X2' Battery Additive Submitted by Post Office Department, Case No. 85372-F," Walter J. Hamer, Chief, Electrochemistry Section, July 17, 1952.

During 1952 and the beginning of 1953 the Bureau was to be swamped with AD-X2 testing. From March 19, 1952, to May 4, 1953, the Bureau tested AD-X2 on 102 old batteries and 24 new ones. This involved testing 378 cells. The tests also involved physical-chemical investigations and chemical analysis. Eleven staff members were involved, including the director for one set of tests. "Resumé of Tests of AD-X2 at the National Bureau of Standards" from *Report on Battery Additives by the National Bureau of Standards*, National Bureau of Standards Report 2447, April 16, 1953.

<sup>78</sup> Letter, Joseph W. Powers, Federal Trade Commission, to John W. McBurney, February 26, 1952. (NARA; RG 167; Astin file; Box 11; Folder P.O. & F.T.C. re AD-X2); National Bureau of Standards, "Report on Examination of AD-X2 Battery Additive Submitted by Federal Trade Commission thru Division 1, Section 8, Project No. 0199," James I. Hoffman, Chief, Surface Chemistry Section, July 8, 1952; National Bureau of Standards, "Report of Test of 'AD-X2' Battery Additive Submitted by Federal Trade Commission," Walter J. Hamer, Chief, Electrochemistry Section, July 21, 1952.

The barium sulfate was a new result. It is insoluble in battery electrolyte and is sometimes used in negative plates to prevent contraction and solidification of the spongy lead paste. Because of its insolubility it cannot be added via the electrolyte.

Along with the POD, the FTC was also in position to institute proceedings against Pioneers.

#### THE SENATE SELECT COMMITTEE ON SMALL BUSINESS GETS INVOLVED

Upon receiving a letter from the POD ordering him to appear in Washington on April, 26, 1952, to answer a charge of mail fraud before a complaint was issued, Ritchie temporarily moved to Washington, taking up residence on Connecticut Avenue, not far from Bureau headquarters. It was to be a pivotal year.

His main intent was to continue the political campaign he had begun against the Bureau, but first he needed legal and scientific help. He hired a lawyer, and sought a consultant to replace Randall. He settled on Keith J. Laidler, assistant professor of chemistry at The Catholic University, a younger man but already well known in the field of chemistry for the outstanding text, *The Theory of Rate Processes*, which he had co-authored in 1941 with Samuel Glasstone and Henry Eyring while at Princeton.<sup>79</sup> Then Ritchie went to Boston to talk to Professor Harold C. Weber of the Massachusetts Institute of Technology. Weber had some years previously written to Pioneers for information on AD-X2. More recently he had been contacted by Norman Goodwin, President of Guaranteed Batteries of Boston and a distributor for Ritchie. Weber had become interested in battery additives and, after being contacted by Goodwin, had, on his own initiative, run some tests on Battery AD-X2. He was not retained by Ritchie, but was to play a very important part in the incident.

One of the first things Laidler did was to write a critique of Circular 504.<sup>80</sup> He pointed out correctly that AD-X2 had numerous satisfied customers, many of whom were experienced battery technicians who were hard to fool, but nowhere mentions the questions of controls in these testimonials. He discounted the Bureau's tests because they "were carried out on batteries that in all probability were in a mechanically unsound condition," and "in view of this the tests described do not constitute a fair or objective trial. . . ." Then he came to the conclusion that the Bureau had not really tested AD-X2 because it stated that the additives used were combinations of sodium and magnesium sulfates, whereas "AD-X2 . . . is not a simple combination of these two sulfates." No data were appended to substantiate that statement. He also went into motivations. "It is difficult to avoid the conclusion that the object of Circular No. 504 was to discourage the average reader from using battery additives by the use of highly technical arguments which would be incomprehensible to him rather than to be informative, objective and educational." Finally he wrote, "It is suggested the Bureau withdraw Circular 504 in the public interest." Laidler's critique was not a document that would endear him to the Bureau staff.

But Ritchie was in Washington primarily to bring political pressure on the Bureau, not solely to talk to scientists. He contacted both the House and Senate small business committees and got a favorable response from both, but the House committee bowed out after the Senate committee became involved. The House committee did, however, ask the Bureau to test AD-X2 on March 11, 1952,<sup>81</sup> during the period when the Bureau was carrying out tests for the POD and the FTC. Events would conspire to make the request redundant.

<sup>79</sup> Samuel Glasstone, Keith J. Laidler, and Henry Eyring, *The Theory of Rate Processes* (New York: McGraw-Hill, 1941).

<sup>80</sup> Keith J. Laidler, "A Critique of the National Bureau of Standards Circular 504 on Battery Additives With Special Reference to 'Battery AD-X2,'" May 15, 1952. (NARA; RG 167; Astin file; Box 10; Folder Laidler)

<sup>81</sup> Letter, Victor P. Dalmas, Select Committee on Small Business of the House of Representatives, to A. V. Astin, March 11, 1952. (NARA; RG 167; Astin file; Box 10; Folder Senate Small Business Committee)

Ritchie's greatest support came from the Senate Select Committee on Small Business (SSCSB). Formed as a permanent body with no legislative jurisdiction, the SSCSB was run with little supervision by a professional staff of six that did not change with a change of majority party in the Senate. Ritchie was referred to Blake O'Connor, one of the staff. A Harvard graduate, he had been employed by several Government agencies, including the Department of Commerce, before becoming a committee staff member. He felt that AD-X2 did work because the battery manufacturers were opposed to it, and he saw in it a test case for the committee's effectiveness. Ritchie had found his champion, and Weber of MIT agreed to become an unpaid consultant for the committee.<sup>82</sup>

O'Connor asked the Bureau to test AD-X2, and for several months worked "with the National Bureau of Standards in an effort to determine the merits of . . . AD-X2."<sup>83</sup> But most important, Weber had agreed to conduct some independent tests on AD-X2 if the MIT administration would agree. O'Connor thus wrote to Julius Stratton, Provost of MIT, requesting this testing. Stratton agreed to have Weber carry out such tests, but did not agree to have MIT comment on tests carried out in other institutions. One of the Nation's most highly respected scientific institutions had entered the argument.<sup>84</sup>

#### FINALLY A PUBLIC TEST

After Condon left the Bureau on September 30, 1951, Astin, while still only acting director (he was not confirmed until May 30, 1952), was in charge. He became personally involved in the AD-X2 affair, and had discussions with Secretary Charles W. Sawyer about it on his very first day. With what seemed like an endless series of requests for testing AD-X2 on his hands, Astin had to find some way to resolve the situation.<sup>85</sup> He determined that if the Bureau were to conduct a test using a procedure agreed to by Ritchie, the latter would have to abide by the results. Not that he lacked confidence in the Bureau's procedures. "Although I had no reason for questioning the adequacy of the test procedures the Bureau had used previously, I had hoped that by using a procedure described by him [Ritchie], the matter could be settled decisively for all concerned," he testified before the Senate.<sup>86</sup> It was to be a fond hope.

Indeed, getting the test under way presented some problems. Whom was the Bureau to contact: Ritchie? The Department of Commerce? The SSCSB? Ritchie himself provided the answer by arriving unannounced at Hamer's office in the company of his wife, his lawyer, and Laidler, and asking that AD-X2 be tested by his procedure. Hamer did not have the authority to make such a decision, so a conference between

<sup>82</sup> Lawrence, *Battery Additive Controversy*: 12.

<sup>83</sup> Letter, B. O'Connor to J. A. Stratton, MIT Provost, October 8, 1952. (NARA; RG 167; Astin file; Box 10; Folder Pioneers Ritchie)

<sup>84</sup> Letters, J. A. Stratton to B. O'Connor, October 9, 1952; M. G. Kispert, Executive Assistant to J. A. Stratton, to B. O'Connor, November 6, 1952. (AD-X2 Hearings: 370)

<sup>85</sup> In early 1952, the Bureau had requests for tests from the POD, the FTC, the House Small Business Committee, the Senate Committee on Small Business, and Senator Richard M. Nixon, among others.

<sup>86</sup> A.V. Astin testimony, AD-X2 Hearings: 222.



Ritchie and Astin was arranged. Astin agreed to a test if Ritchie would provide a procedure that would also be acceptable to the Bureau, and Ritchie did provide a procedure, called by him the "suicide test." At conferences between Ritchie and the Bureau staff, modifications to the test were agreed upon. These, and the method of conducting the tests, were sent to Ritchie by Astin on May 23, 1952, for Ritchie's concurrence.<sup>87</sup> Half of the batteries to be used in the test were to be treated with AD-X2 and the remainder left untreated. A feature of the test was that the batteries were numbered, but would be treated at random. Only Astin was to have the key as to which were treated and which were not; the scientists carrying out the laboratory work would not know which batteries were which. "Here I believe that it is important to point out that had we put AD-X2 in all of the batteries rather than in just half of them, we would have duplicated the experience reported by most of the proponents of AD-X2," Astin later testified.<sup>88</sup> A further feature of the tests was that a panel of experts, including Ritchie's people, were to inspect plates removed from ten batteries—five untreated and five treated, chosen at random—after the tests, and rate their condition. Ritchie was also allowed to have an observer (not himself) during the tests. As might be expected, the panel of experts was unable to distinguish between treated and untreated plates.

Astin's letter to Ritchie contains the statement, "If the tests do not establish definitely the usefulness of your product, I will expect you to concur that it has not been possible to demonstrate the value of your product. If the tests show conclusively that your product is of value, then the Bureau's position on battery additives will have to be modified." Whatever the results, Astin expected that they would have decisive effects.

There was, however, one seemingly minor point that was to give Ritchie a loophole through which he could wriggle. This concerned a technical question on the addition of water during charging of the batteries. Ritchie required that if the specific gravity of the electrolyte rose above 1.280, acid was to be removed and replaced with water to bring the specific gravity down to 1.280. The Bureau opposed this for the following reason. The mere addition of AD-X2 to the electrolyte increased the specific gravity by a small but measurable amount. Thus, it is entirely possible that the specific gravity of the treated batteries would rise above 1.280 and so require that acid be removed and water added, while the untreated batteries would not. As a result the two sets of batteries would not have received the same treatment, and the scientific validity of the comparison would be compromised. Discussions went back and forth, and finally, just a few days before the test, a compromise was achieved—or at least so Astin thought. The limit would be raised to 1.325, and if a certain percentage of cells in a given

---

<sup>87</sup> *Report on Battery Additives by the National Bureau of Standards*, National Bureau of Standards Report 2447, April 16, 1953; "Manufacturer's 'Procedure for Testing Battery AD-X2 (Suicide Test),' " NBS Report 2447, Appendix 1.1; letter, A. V. Astin to J. M. Ritchie, May 23, 1952. NBS Report 2447, Appendix 1.2; letter, J. M. Ritchie to A. V. Astin, May 26, 1952. NBS Report 2447, Appendix 1.3.

<sup>88</sup> A. V. Astin testimony, AD-X2 Hearings: 223.

charging line exceeded this value, acid would be removed and water added to all.<sup>89</sup> It seemed a minor point and nothing was in writing, but Ritchie was to claim that his instructions were not followed, and this gave him an opportunity to dispute all the results.

Under constant pressure from Ritchie to provide a report,<sup>90</sup> the Bureau issued one on July 11, 1952. This was followed with a list of minor mathematical corrections on September 5. AD-X2 was still not named.<sup>91</sup> The conclusions were predictable: "The results of the . . . investigation . . . indicate that the battery additive tested has no beneficial effect on the properties or performance of batteries."

If the conclusions were predictable, so was Ritchie's reaction. He had not agreed on the specific gravity modification, and it "was not a minor deviation but was a ruinous deviation."<sup>92</sup> Moreover, there were "nine other modifications of our original test procedure."<sup>93</sup> Astin's hopes of resolving the situation with a public test were dashed. Four years after it began, the battery additive incident was no closer to a resolution than it had been at the start.

### MIT CONDUCTS TESTS WITH SEEMINGLY STARTLING RESULTS

Ritchie was not alone in refusing to accept the results of the Bureau's open test. He was joined by his consultant Laidler and by O'Connor of the SSCSB. O'Connor and Laidler had meetings with Astin, at which Laidler criticized the Bureau's conduct of the tests and the conclusions drawn.<sup>94</sup> At O'Connor's request, a large meeting was

<sup>89</sup> *Ibid.*, 245.

<sup>90</sup> Astin recounts an amusing story about Ritchie's persuasiveness. Speaking of the period during which the test was underway, he recalls, "Ritchie was in my office all the time the tests were being run and the results were being evaluated. He would sit out with Miss Kingsbury [Astin's secretary] in the outer office and chat with her. And when we finally got the results and Ritchie called me and I had to tell him that the results were not favorable to him, Miss Kingsbury said to me. 'I am sorry you had to tell him that. He is the nicest man.' He had her completely sold. He was a 'good guy.'" (Interview with A. V. Astin, July 12, 1983; NIST Oral History File)

<sup>91</sup> National Bureau of Standards, "Test of a Battery Additive," September 5, 1952. (NARA; RG 167; Astin file; Box 9; Folder Investigations of Battery Additives at NBS)

<sup>92</sup> J. M. Ritchie testimony, AD-X2 Hearings: 143.

<sup>93</sup> *Ibid.*, 148.

<sup>94</sup> At a meeting on July 29, 1952, upon O'Connor's departure, Astin asked Laidler to stay on. Then, according to Laidler, Astin proceeded to berate him, stating that anyone who did not believe the evidence against AD-X2 was not using sound scientific judgment. Astin also allegedly threatened to speak to Professor F. O. Rice, chairman of the Chemistry Department at Catholic University, where Laidler was an assistant professor. (Letter, K. J. Laidler to J. M. Ritchie, August 5, 1952; AD-X2 Hearings: 150) There clearly was a serious argument between the two men. Laidler's comments about Circular 504 could hardly have endeared him to Astin. Indeed, two days after the meeting, Archibald T. McPherson, associate director of the Bureau, wrote to Rice. His letter reads in part, "Mr. O'Connor of the U.S. Senate Committee on Small Business and Dr. Laidler had a long discussion with Dr. Astin yesterday regarding the Bureau's recent investigation on battery additives. In the course of the conversation, Dr. Laidler said he had no objection to our acquainting you with his activities on this subject. . . ." McPherson enclosed Laidler's critique of Circular 504, two other Laidler publications, and the Bureau's July 11 report on the public tests. He then continued, "I am bringing these documents to your attention because they point to a disagreement between a member of your University and this Bureau of so serious a nature that it is suggested that one of our publications should be withdrawn in the public interest." (Letter, A. T. McPherson to F. O. Rice, July 31, 1952)

This letter is a clear reminder that neither side in the controversy was playing softball.

convened at the Bureau on September 29, 1952. Present at the meeting were Ritchie, O'Connor, Laidler, Professor Weber of MIT, Astin, members of the Bureau staff, two representatives of the POD, and a representative of the Department of Justice. At this meeting Weber presented some preliminary tests that purported to show differences between untreated batteries and those treated with AD-X2. The Bureau agreed to try to check these results if a description of the testing procedures could be obtained. The Bureau made several attempts to obtain the procedures, but they were not made available until MIT had issued its own report in December on subsequent tests, by which time the situation had changed dramatically. Several weeks after the September 29 meeting, the Bureau was informed by O'Connor that MIT was beginning a more complete series of tests to check on its preliminary results. At the request of O'Connor, this work was to be carried out by MIT as a public service. But MIT would not evaluate the work of other groups.<sup>95</sup> The Bureau was invited to participate, but decided not to do so, believing that unfavorable results would be more acceptable to the proponents of AD-X2 if it did not participate. Considering what was to happen, this may have been an error.

The results were not negative. Carried out at MIT by a team of distinguished faculty members led by Weber, the work was completed in early December. A report on the work was hand-carried from MIT to O'Connor on December 16, 1952.<sup>96</sup> Two days later the SSCSB issued a long press release. Containing a summary of the MIT results, a long set of comments and a background statement by Laidler (now identified as a consultant to the Committee), and a supporting statement by the OBBB, the press release was bombshell. In Laidler's words from the release:

The Massachusetts Institute of Technology test, carried out at the special request of the Senate Small Business Committee, constitute[s] by far the most thorough scientific tests of the effectiveness of Battery AD-X2. They demonstrate beyond reasonable doubt that this material is in fact valuable, and give complete support to the claims of the manufacturer. They also show additional desirable effects not specifically claimed by the manufacturer.<sup>97</sup>

---

<sup>95</sup> Letter, M. G. Kispert, Executive Assistant to J. A. Stratton, to B. O'Connor, November 6, 1952. (AD-X2 Hearings: 370)

<sup>96</sup> Harold C. Weber, "Some Facts Concerning the Effect of Battery Additive AD-X2 on Lead-Acid Batteries," Cambridge, Mass., December 1, 1952.

On the following day, Astin was asked by O'Connor if the Bureau would care to review the report that day in the Senate Office Building, whereupon Astin sent Hamer, accompanied by Archibald T. McPherson, associate director for chemistry, to review the report. When O'Connor asked the two men to meet with the press, they declined, stating that they would need more time for their review. The Bureau received an official copy a week later.

<sup>97</sup> Senate Small Business Committee press release SSB #109, December 18, 1952.

Laidler went on to castigate the Bureau in no uncertain terms. After listing alleged flaws in the NBS work, he continued, "We have seen what the technical objections to the Bureau's tests were; our present concern is how the Bureau could dare to make such grave errors." He came to the conclusion that because of their long history of work with batteries, and an implied association with battery manufacturers, "they were simply psychologically incapable of giving Battery AD-X2 a fair trial." Magnesium and sodium sulfates were ineffective? Why, of course, but could it not be that (unspecified) contaminants in AD-X2 might have had a catalytic effect? Failure to take this into account was "erroneous and reprehensible." In their stridency, Laidler's comments rivalled those he had made in his critique of Circular 504.<sup>98</sup>

Widely reported in the press, the release left the public confused. Here were two of the Nation's most eminent laboratories arriving at diametrically opposed conclusions on such a seemingly simple thing as deciding whether a battery additive was good or bad. "NBS on the Spot," headlined *Newsweek*.<sup>99</sup> How could this happen?

The answer was not long in coming. Significantly, the press release omitted a comment in the MIT report by Professor James A. Beattie, a member of the MIT team. In the form of an evaluation of the results, he wrote, "In conclusion, I would say that the addition of AD-X2 certainly does have an effect on the behavior of a lead-acid battery. From my brief contact with the work, I cannot say that this effect is correlated with a beneficial action from the standpoint of the normal use of such a battery." In fact, the MIT report made no evaluation of the results. In his covering letter to the report, Stratton wrote, "I would point out . . . there are no recommendations included in the report, nor did our group arrive at any definitive conclusions with respect to the commercial value of the product."<sup>100</sup> The Bureau was soon to quantify this matter.

Immediately upon receiving the MIT report, the Bureau set out to check the MIT results, and reported its findings in a report, "Statement on Battery Additives" to the House Interstate and Foreign Commerce Committee, which had jurisdiction over the Bureau.<sup>101</sup> It was immediately apparent that the MIT work dealt with very dilute acid solutions found only in discharged or nearly discharged batteries, and the Bureau could confirm only one finding out of eight: the so-called "bubble effect," in which treated cells formed much smaller bubbles on charging than untreated cells. Even this effect was noticeable only at such low acid concentration and slow charging rates that it was unimportant in normal operation, such as in automobiles. Contrary to the MIT results,

---

<sup>98</sup> Laidler was to claim that he did not write the portion of the analysis beginning with the phrase, "our present concern is how the Bureau could dare to make such grave errors." (Lawrence, *Battery Additive Controversy*: 17)

<sup>99</sup> *Newsweek*, December 22, 1952: 53.

<sup>100</sup> Letter, J. A. Stratton to B. O'Connor, December 16, 1952.

<sup>101</sup> U.S. Department of Commerce, National Bureau of Standards, "Statement on Battery Additives, prepared for the Committee on Interstate and Foreign Commerce, U.S. House of Representatives," February 10, 1953.

the Bureau did not find that batteries with low acid concentrations operated at lower temperatures than untreated batteries, nor did they find that AD-X2 increased electrical capacity or charging efficiency. Moreover, mixtures of magnesium and sodium sulfates showed the same behavior as AD-X2, effectively demolishing Laidler's "catalytic impurity" hypothesis. Battery AD-X2 was still a not-very-well-controlled mixture of sodium and magnesium sulfates. By working with a very dilute electrolyte, MIT had uncovered one minor positive effect, but it was of academic interest only and had nothing to do with the normal operation of batteries such as operating a car.<sup>102</sup>

### THE POST OFFICE DEPARTMENT TAKES ACTION

In the fall of 1952, its own tests at the Bureau being complete, and the results of the Bureau's public test now being available, the Post Office scheduled its oft-delayed fraud hearings for October 13 and 14.<sup>103</sup> Allen Astin and seven Bureau scientists testified, but Ritchie did not.<sup>104</sup>

Ritchie had, in fact, returned to California shortly before the hearings were to begin. Oddly, he fired his lawyers, which caused him some problems, for he did not know the laws that governed hearings such as the one being held. He did not recognize, for example, that affidavits submitted on his behalf were not admissible as evidence unless the person giving the affidavit was present at the hearing to present it, although the hearing examiner could take it into account in arriving at a decision. In fact, W. C. O'Brien, assistant solicitor for the POD, pointed out some of the points of law to Ritchie. According to O'Brien's statement at the POD hearings, Ritchie had decided as early as October 1 to forego the hearings, figuring eventually to bring suit in court should they result in a judgment against him. O'Brien pointed out to him that he could not do this, for a court would require that he had exhausted his administrative remedies before taking the case to court, and this hearing was clearly such a remedy. Indeed, O'Brien offered to him the option of giving up his mail order business (which was less than 1 percent of Ritchie's business) whereupon the POD action against him would be dropped. Ritchie refused, and the hearings went on.<sup>105</sup>

<sup>102</sup> The Bureau went beyond simply checking the MIT results. In tests designed to obtain further supplementary information, it was found that AD-X2 had a slightly detrimental effect in some tests. The tests showed that AD-X2 slightly retarded the charging of negative plates, it increased the resistivity of the electrolyte except for very dilute electrolytes outside the range of normal battery operation, and it increased the viscosity of the electrolyte. These detrimental effects, however, "are so small . . . that . . . they can be discarded or not considered. . . . [I]f it were on the helpful side rather than the hindering side we would not consider it even then of sufficient importance to be considered as beneficial." (A. V. Astin testimony, AD-X2 Hearings: 319) Further details are in NBS Report 2447.

<sup>103</sup> "Before a Hearing Examiner for the Post Office Department, Holding a Fraud Order Hearing, In the Matter of Pioneers, Inc., at Oakland, California. Transcript of Proceedings, October 13, 14, 1952, Washington, D.C." A good account is also given in Lawrence, *Battery Additive Controversy*.

<sup>104</sup> The scientists were Hymin J. Feinstein, James I. Hoffman, and Bourdon F. Scribner of the Chemistry Division; D. Norman Craig, Clarence L. Snyder, and Walter J. Hamer of the Electrochemistry Section; and Churchill Eisenhart of the Statistical Engineering Laboratory.

<sup>105</sup> W. C. O'Brien testimony, POD Hearings: 4.

With only one side participating, the hearings were rather routine. The Bureau people explained their results and answered the questions of the solicitors and the examiner, sometimes in great detail. But two comments by Astin toward the end of the hearings were particularly interesting in that they illustrated the Bureau's feeling in the matter at this time. When asked about testimonials, Astin answered without equivocation: "Nobody else has run a controlled experiment. And in the absence of any controlled experiment showing the merit of the battery additive I find it difficult to give any weight to any of the testimonials."<sup>106</sup> His personal feelings are well illustrated by his comments about Weber's position at the September 29 meeting that preceded the MIT experiments. Astin testified, "During the course of this meeting, Dr. Weber seemed to give considerable more credence to the scientific conclusions which he attempted to draw from the experiences of battery service men than he did from the observation of our organization, and any man who does that, I would question his scientific conclusion."<sup>107</sup> There was little doubt about where Astin, and hence the Bureau, stood on the AD-X2 matter.

Early in 1953, Ritchie tried to get the POD to reopen his case.<sup>108</sup> With the help of O'Brien and O'Connor of the SSCSB, he filed an "Application for Correction of Default." It was denied. Ritchie had defaulted deliberately, the examiner found, and the MIT tests and Laidler's comments, which Ritchie had quoted in his application, did not "go to establish the validity of the respondent's advertising claims." On February 24, 1953, Ritchie's mail was stopped and returned to the sender marked "Fraudulent." If maintained, the order would be a great blow to his business.

The order did not last long.<sup>109</sup> The political process was quick to restore Ritchie's standing.

#### THE BEGINNING OF THE RESOLUTION

By early 1953 it had become clear that the AD-X2 incident would never be resolved in the scientific arena. The proponents of the additive, led by Ritchie and with Laidler as point man on scientific questions, would not accept any result that did not show that their product was valuable and did all that they claimed. The Bureau, confident that its experiments had been designed and carried out by the world's foremost experts, was not about to change its conclusion that AD-X2 was ineffective. Nor was it about to carry out field tests. These were not called for, it believed, for the laboratory tests gave no reason to expect that field tests would suddenly prove AD-X2 to be meritorious. Moreover, field tests were expensive, and neither of the Bureau's clients—the FTC and the POD—had specifically asked for them. And, one presumes, there was the definite

---

<sup>106</sup> A. V. Astin testimony, POD Hearings: 92.

<sup>107</sup> *Ibid.*, 93.

<sup>108</sup> Lawrence, *Battery Additive Controversy*: 19.

<sup>109</sup> Post Office Department Press Release No. 977, August 20, 1953.

feeling that even if the field tests also showed the material to be without merit, the AD-X2 proponents would find yet other reasons not to accept the test results. It seemed that a complete impasse had been reached.

In an unusual twist, the impasse was to be ended, if not resolved, from a most unexpected quarter: the change in administration that came with the 1952 presidential elections. And that the ending should occur in an almost bizarre way seems fitting for this strange, convoluted affair.

Running on an anti-New Deal, pro-business, anti-corruption, anti-Communism platform, and featuring a pledge to end the Korean conflict, the Republican Eisenhower-Nixon ticket rode roughshod over the Stevenson-Sparkman Democrats, winning the White House as well as both houses of Congress. A changed philosophy of Government had been installed in Washington, one best exemplified by the nomination as secretary of defense of Charles ("Engine Charlie") Wilson, president of General Motors, whose statement, "What's good for the country is good for General Motors and vice versa," was added to the lexicon of the Nation's political history.

Equally emblematic of the changed philosophy was the appointment of Sinclair Weeks as secretary of commerce. A Harvard graduate, banker, businessman, ex-president of the National Association of Manufacturers, and son of John W. Weeks, secretary of war in the Harding and Coolidge administrations, Weeks came into office promising "to create a 'business climate' in the nation's economy." In Goldman's words, he was to express "the new order of things . . . in a form so extreme that it amounted to a caricature."<sup>110</sup>

As soon as he learned in December 1953 that Weeks had been appointed secretary of commerce, and hence overseer of the Bureau, Ritchie and his distributors began another writing campaign. Weeks' mail was filled with material about the merits of AD-X2, and the difficulties the manufacturer and distributors were having with the Bureau. By sheer coincidence, one of the companies of which Weeks was a director had a battery that was presumably "used up," and had bought a replacement battery for \$1300. But after being worked on by "these battery AD-X2 people" the old battery was revived, and was still working after thirteen months. The new battery was "standing in the corner."<sup>111</sup> Lady Luck had smiled on Ritchie.

When Weeks took office, he installed his own people at the assistant secretary level, and got rid of 1330 others as an economy measure.<sup>112</sup> As assistant secretary for domestic affairs he appointed Craig R. Sheaffer, a former president of the Sheaffer Pen Company.<sup>113</sup> Sheaffer's position gave him supervisory authority over the Bureau, and Weeks asked him to investigate the AD-X2 matter. Ritchie worked closely with Sheaffer in the investigation.

---

<sup>110</sup> Eric F. Goldman, *The Crucial Decade—and After: America, 1945-1960* (New York: Vintage Books, 1960): 241-242.

<sup>111</sup> Secretary Sinclair Weeks testimony, AD-X2 Hearings: 4.

<sup>112</sup> Lawrence, *Battery Additive Controversy*: 18.

<sup>113</sup> Newspaper accounts alleged that Sheaffer was upset with the Government because of an FTC investigation of the Sheaffer "lifetime" pen, and with the Bureau for "high-handed" testing of a pen. (Lawrence, *Battery Additive Controversy*: 19) The Bureau never tested a Sheaffer pen. (Interview with A. V. Astin, July 12, 1983; NIST Oral History File)

Astin tried to see Weeks, but his efforts were to prove fruitless. Indeed, recognizing that the Department did not, in Astin's words, have "confidence in the adequacy of the Bureau's work on battery additives," he urged Weeks in writing to enlist the assistance of the Bureau's Visiting Committee and the National Academy of Sciences to form two committees, one to study the Bureau's operations, and another to study the accuracy of the Bureau's scientific work. Astin never heard from Weeks, but his proposal was to be implemented in a manner he could hardly have expected.

One of the first things that happened after Weeks took office was the rescinding of the POD fraud order. With a new leadership in Congress, the chairman of the Senate Small Business Committee was now Edward J. Thye of Minnesota, but the professional staff had not changed. Ritchie, with the help of O'Connor, persuaded Thye to help him on the POD fraud order, and Thye provided a supportive letter of transmittal for a petition Ritchie had written for delivery to Postmaster General Arthur Summerfield. Weeks, in turn, also provided a request that the fraud order be rescinded, and the documents were delivered to Summerfield at his home on Friday, February 27. Following a morning conference among Summerfield, Weeks, and Sheaffer and their top aides, Summerfield approved Ritchie's request and suspended—but did not repeal—the fraud order. It had lasted three days. Ritchie could receive mail again and was back in business.

Sheaffer's investigation continued. Investigators from the Department of Commerce went meticulously through the Bureau files. The Bureau, following its normal course of operation, prepared the "Statement on Battery Additives"<sup>114</sup> for the House Interstate and Foreign Commerce Committee and submitted it without notifying Sheaffer that it was doing so. Furious, Sheaffer ordered that further copies be impounded and, in response to an inquiry about AD-X2, wrote to a trade journal:

The new administration officials of the Department of Commerce report that they have not had time to complete their study of the question of battery additives. Therefore, they have not yet made a final decision as to their attitude on previous opinions of the National Bureau of Standards on the value of such additives.

In fact, on March 4, 1953, Sheaffer ordered that all dissemination of information on battery additives by the Bureau be halted. From then on a form letter containing the following statement was sent to anyone (except agencies of the Government) requesting information on battery additives, "The Department of Commerce is currently studying the battery additive matter and pending the completion of their study, the National Bureau of Standards is not disseminating any information on the subject."<sup>115</sup>

<sup>114</sup> National Bureau of Standards, "Statement on Battery Additives, Prepared for the Committee on Interstate and Foreign Commerce, U.S. House of Representatives," February 10, 1953.

<sup>115</sup> NARA; RG 167; Astin file; Box 6; Folder Battery Additive 1953. Indeed, within a few days of the Sheaffer order, Jesse L. Mathusa, who was in charge of Bureau publications, received a call from the Commerce publications chief. He was told to burn all copies of Circular 504, but they settled for impoundment. In addition, Raymond Davis, chief of the Bureau's Photographic Laboratory, made a photographic copy of the data on which Circular 504 was based to assure its retention.



Sheaffer was rapidly making up his mind. He became convinced that the Bureau had mishandled the AD-X2 affair. He was convinced by the testimonials and the large number of satisfied users that AD-X2 was a worthwhile commodity and that Ritchie had been unfairly prevented from selling it. A massive Government had prevented a small businessman from making a living. This was just the type of unfair treatment that both Weeks and Sheaffer had come to Washington to prevent. Sheaffer recommended that Astin be fired.<sup>116</sup>

#### ASTIN IS FIRED AND WEEKS LEARNS THE WAYS OF WASHINGTON

Despite the fact that the director of the Bureau was a civil servant, he, and others like him in similar positions in the bureaucracy, served at the pleasure of the president. Civil service rules did not apply to these positions. Thus, it was not uncommon that the holder of such an office be asked to resign at a change of administration. But at the National Bureau of Standards this had never happened; the position of director was considered to be a professional, not political, position. Astin was the first Bureau director whose resignation was requested.

After receiving the recommendation from Sheaffer, and discussing the whole case with the top-ranking officials in his administration (but not Astin), Weeks agreed with Sheaffer. It was, however, by no means a decision agreed to unanimously by Weeks' staff—Sheaffer was its main proponent.<sup>117</sup> Nor is it clear that Weeks was aware of the nature of Astin's position. It seems, in fact, that Weeks considered the firing not much different from the type of house-cleaning he had carried out with the political staff, and Astin appears to have considered it in this light as well. Whatever the facts, the decision was made. On March 24, 1953, Astin was called into Sheaffer's office and told that the secretary desired his resignation "in order to study and make changes in the operations of the National Bureau of Standards."<sup>118</sup> In his statement on resigning, Astin said, "When Mr. Sheaffer informed me that the Secretary desired my resignation, I felt I had no alternative to submitting it. Unless the Director of the National Bureau of Standards has the full support and cooperation of the Secretary of Commerce, the effectiveness of the important services which the National Bureau of Standards renders to science, industry, and government would be seriously impaired." On March 30, his short resignation letter was sent to the president, and two days later President Eisenhower accepted it, effective April 18.

---

<sup>116</sup> Lawrence, *Battery Additive Controversy*: p. 20.

<sup>117</sup> The main supporter of Astin was Assistant Secretary for Administration James C. Worthy. He tried to stop Astin's firing but was unsuccessful. Only a few months later, Worthy was to replace Sheaffer as Astin's immediate superior. (Herman Wolkinson, "Memorandum of a Phone Conversation with James C. Worthy on November 25, 1959." NARA; RG 167; Astin file; Box 7; Folder untitled [legal size]. Wolkinson was a senior trial attorney for the Department of Justice)

<sup>118</sup> Statement on Resignation by Dr. A. V. Astin, Director, National Bureau of Standards, April 1, 1953, 5:30 p.m. (NARA; RG 167; Astin file; Box 6; Folder 0/9.46 Battery Additives)

Again with almost miraculous coincidence, the SSCSB had scheduled hearings for Weeks alone on the afternoon of March 31, 1953. In that morning's *Washington Post* and 300 other newspapers throughout the country, a column by Drew Pearson entitled "Astin Ouster Laid to Influence" appeared. It read, in part:

Dr. A. V. Astin, Director of the National Bureau of Standards . . . has been trying for several weeks to get an appointment with his chief, the new Secretary of Commerce, Sinclair Weeks. As the head of one of the non-political, scientific bureaus of Government, he wanted to discuss future problems.

Secretary Weeks, however, did not see him. But last week, Dr. Astin suddenly was summoned . . . by Assistant Secretary Craig Sheaffer, head of the fountain pen company, and was fired. He was asked to turn in his resignation within three days.

He also was lectured regarding the Bureau of Standards' diagnosis of battery additives. . . . Sheaffer didn't like this diagnosis and told Dr. Astin the Bureau of Standards in the future was to be run on a businessman's basis.<sup>119</sup>

That very afternoon, Weeks, accompanied by Sheaffer, testified before the SSBC. The session lasted only thirty-five minutes, but, coupled with the Pearson column and the announcement of Astin's dismissal, it was to make a far longer-lasting impression on the Nation. In his prepared testimony, Weeks gave a short account of the history of the AD-X2 affair. As expected, it was quite sympathetic to Ritchie. Then Weeks quite accurately put his finger on the heart of the matter with respect to the Bureau's position on situations of this kind:

The Bureau, which is supposed neither to approve nor condemn a product, has, by its very setup, the power to make the introduction of a new product on the market very difficult, to prevent a product's being advertised by the Federal Trade Commission action, and have people labeled "fraud" and denied the use of the mails. If this power is objectively and correctly used, it has great value to all the people of this Nation. However, if the Bureau's foot slips, a business starting in against all the normal competitive hazards, finds itself up against something with which it cannot cope, the vast power of the United States Government. Unless the small-business man knows a very great deal about Government, or has the finances to employ experts, he is obliged to quit.

I cannot bring myself to believe that the people making AD-X2 have the intent to defraud—and without intent, I do not see how there can be fraud.<sup>120</sup>

Despite the fact that Weeks rather clearly believed that the Bureau's "foot had slipped" in the AD-X2 matter, as an analysis of the Bureau's position and power in such matters the statement was largely accurate. He made three promises: To "get the

---

<sup>119</sup> Drew Pearson, "Astin Ouster Laid to Influence," *Washington Post*, March 31, 1953.

<sup>120</sup> Weeks testimony, AD-X2 Hearings: 3.

best brains I can to examine into the functions and objectives of the Bureau of Standards; . . . ” to re-test AD-X2, including field tests; and to withdraw “Circular 504 and all other circulars and technical reports dealing with battery additives until such time as those tests are completed.” He was to carry out the first and third of these promises.<sup>121</sup>

Had he left the matter there, his testimony would have been important enough, but he included another statement which, coupled with the Astin dismissal, was to bring the wrath of the scientific community and a large portion of the press down on his shoulders:

I am not a man of science, and I do not wish to enter into a technical discussion or be accused of overruling the findings of any laboratory. But as a practical man, I think that the National Bureau of Standards has not been sufficiently objective, because they discount entirely the play of the market place. . . .<sup>122</sup>

Widely interpreted as meaning that science should come up with results that are politically acceptable, this comment, coupled with Astin’s dismissal, unleashed a storm of criticism on Weeks. Editorials appeared almost immediately in the *Washington Post*, *The Washington Times*, *The New York Times*, and *The Los Angeles Times*. Other papers followed. “The public has a right to know whether there is any plan to mix politics with the scientific objectives of the NBS,” wrote the *Post*. “Now the new administration chops off the head of the top man in a bureau whose effectiveness depends on its freedom from accountability to any other standard than scientific integrity,” wrote the *Pittsburgh Post-Gazette*. Political cartoonists had a field day. Congressional reaction was generally unfavorable. “If this is the only incident, it is a pretty stiff penalty,” said Senator John Sparkman. Senator Wallace F. Bennett commented that the additive problem “has been handled in such a way as to injure [Astin] and the Commerce Department.” Further criticism came from private citizens and other segments of the population, but the most serious was from scientists and scientific organizations. The Federation of American Scientists led the way with a statement issued by their Executive Committee on April 4. “Resentment and apprehension have been aroused not only by the injustice done a respected colleague, but by a shadow thrown on the working relationship between science and government.”<sup>123</sup> The

<sup>121</sup> *Ibid.*, 4. On April 7, 1953, Sheaffer strengthened his ban on the distribution of publications on battery additives. The Bureau was directed to “withhold from issue and distribution Circular 504 and all other technical reports dealing with battery additives.” (*Washington Star*, April 11, 1953). All such material was collected and stored in the attic of the South Building. As well as can be determined, this ban was never lifted. (W. R. Tilley, private communication.)

In addition, the Department of Commerce issued an order requiring its review of “proposed new publications projects.” The Bureau staff was notified by Wallace R. Brode, chairman of the Bureau’s Editorial Committee, on April 8, 1953, that “each Division’s program involving the preparation of manuscripts for issuance as NBS Circulars, Handbooks, Applied Mathematics Series, Building and Structure Reports, and Miscellaneous Publications must receive this advance approval.”

<sup>122</sup> *Ibid.*, 3.

<sup>123</sup> Federation of American Scientists, Executive Committee, “Text of Statement on Dismissal of Dr. Astin,” April 4, 1953. (NARA; RG 167; Astin file; Box 6; Folder 0/9.46 Battery Additives)



Sinclair Weeks, secretary of commerce from 1953 to 1958, accused NBS of not being "sufficiently objective" in the AD-X2 matter "because they discount entirely the play of the market place. . . ." Weeks would eventually prove to be a great ally of the Bureau. (AP-Wide World Photos)

prestigious American Physical Society followed on April 8 with a statement from its executive committee: "Rightly or wrongly, the impression has got abroad that the resignation was forced for political or arbitrary reasons. Such an impression, unless corrected, will greatly impair the morale of scientists now working for the government and will make it increasingly difficult to draw other scientists into careers in government service. . . ." "Astin Ouster Assailed in West," ran the headline on a story about the reaction of West-Coast scientists in the *Christian Science Monitor*, which was otherwise one of the few papers that did not criticize the Astin dismissal. Even the august *Fortune* published a two-page factual article on the dismissal.

The Bureau staff itself was dumbfounded. While many had been aware of the AD-X2 problem before Astin's firing, and had been deeply concerned about it, after the dismissal the staff became a seething ferment. They could not believe that their gentle and highly respected director could have been summarily fired. As many as 400 threatened to quit if the situation did not change, including, as usual, some of the brightest and best, for they had plenty of offers from other organizations. The situation was particularly acute in the ordnance divisions, prompting W. S. Hinman, Jr., associate director for ordnance, to write to Wallace R. Brode, acting director after Astin's firing. Hinman wrote:

The dismissal of Dr. Astin and the AD-X2 controversy place the entire Ordnance Program of the National Bureau of Standards in extreme jeopardy.

"Go Away, Boy — You Bother Me"



Copyright 1953 by Herb Block in The Washington Post

COPYRIGHT 1953 BY HERBLOCK IN THE WASHINGTON POST

"Yes, I'm Getting Quite A Charge Out Of It"



Copyright 1953 by Herb Block in The Washington Post

COPYRIGHT 1953 BY HERBLOCK IN THE WASHINGTON POST

HERE'S MUD IN YOUR EYE!

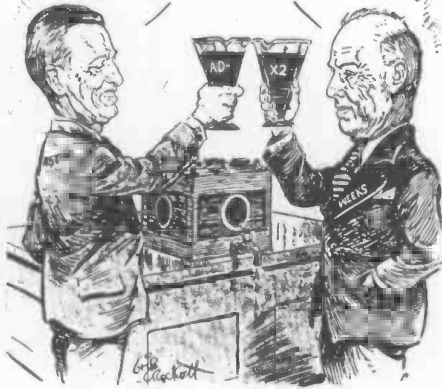

Happy Days!

COPYRIGHT 1953 THE WASHINGTON POST REPRINTED WITH PERMISSION



New Battery Additive

COPYRIGHT 1953 THE WASHINGTON POST REPRINTED WITH PERMISSION

The high profile of the AD-X2 affair kept the cartoonists in Washington, D.C. supplied with material for their graphical observations on the political events of the day.

In one area alone, any disturbance will set back the multi-billion dollar guided missile program of the Nation, and loss of personnel would be a major catastrophe. . . .

Ever since the first news release on AD-X2, I, together with the Chiefs of the Ordnance Divisions, have paid close attention to the temper of the Ordnance Staff. We have concluded that unless the whole matter is resolved fairly and openly, the staff will accept the frequent very-high-salary offers of industry and the Ordnance Divisions will become completely impotent in less than a year.<sup>124</sup>

Suddenly, AD-X2 threatened to become linked to national security.

Senator Thyne promised to hold hearings before the Senate Small Business Committee so that Astin could have his say. Hearings were eventually held on June 22-26, but Astin's dismissal was barely mentioned.

### THE VISITING COMMITTEE

Now the Bureau's Visiting Committee was drawn into the action.<sup>125</sup> As he had promised in his testimony, Weeks promptly set about to form a committee to "evaluate the present functions and operations of the Bureau of Standards in relation to the present national needs." He immediately had a two-hour conference with Detlev W. Bronk, president of the National Academy of Sciences, and Mervin J. Kelly, president of the Bell Telephone Laboratories.<sup>126</sup> Both men were members of the Visiting Committee. Following that conference, on April 3, 1953, just three days after testifying, Weeks sent a telegram to seven scientific societies asking each to nominate a person to serve on the proposed evaluation committee.<sup>127</sup> Bronk had nominated Kelly to serve as chairman of the new committee. In due course, the committee would be formed, but only after some considerable drama.

Oddly enough, only Kelly had knowledge of Astin's ouster before reading about it in the public press. How much this affected subsequent events is not known, but it

---

<sup>124</sup> Memorandum, W. S. Hinman to W. R. Brode, April 13, 1953. (NARA; RG 167; Astin file; Box 6; Folder Battery Dopes, Decoy Letters??)

<sup>125</sup> Provided for in the Bureau's enabling legislation, the Visiting Committee reviews the Bureau yearly, and reports to the secretary on "the efficiency of its scientific work and the condition of its equipment." (Act of 22 July 1950, *U.S. Statutes at Large*, 64 (1950): 371) The Committee is formed of distinguished scientists and scientist-administrators. In April 1953 the members were: Robert F. Mehl, Carnegie Institute of Technology, chairman; Detlev W. Bronk, president of The Johns Hopkins University and president of the National Academy of Sciences; Mervin J. Kelly, president, Bell Telephone Laboratories; Donald H. Menzel, Harvard Observatory; and J. H. Van Vleck, Harvard University.

<sup>126</sup> Federation of American Scientists, *FAS Newsletter*, April 4, 1953, quoting the *New York Times*, April 4, 1953. (NARA; RG 167; Astin file; Box 6; Folder 0/9.46 Battery Additive)

<sup>127</sup> The societies were: the American Institute of Physics, American Institute of Electrical Engineers, American Society of Mechanical Engineers, American Society of Civil Engineers, American Institute of Mining and Metallurgical Engineers, American Chemical Society, and Institute of Radio Engineers. *Physics Today* 6, no. 5 (May 1953): 21.

is bound to have had some effect. Whether the members of the Visiting Committee notified Astin about the developments is also not known, but it seems likely that ordinary courtesy would have led a member of the Visiting Committee to inform Astin of the turn of events.

So far Weeks had not met with the full Visiting Committee, and a meeting was scheduled for April 14, just four days before Astin's resignation would become effective. The committee was unhappy with the turn of events. Indeed, on that morning, "Weeks received a stiff letter from Dr. Bronk in which, for the first time, it was suggested that Weeks countermand the dismissal of Astin 'at least' until the issues could be fully studied. . . . '[T]he integrity of scientific effort and the national interest' demanded that Astin's departure be postponed."<sup>128</sup> And Weeks also wanted the Academy to form another committee to study how the Bureau had dealt with AD-X2. Bronk, president of the National Academy, refused to accept this responsibility unless Astin were retained on a temporary basis.

With the two committees hanging in the balance, Weeks could do little except accede to Bronk's and the Visiting Committee's request. On April 17, one day before Astin's resignation was to become effective, Weeks announced that Astin would remain as director until the matter was cleared up. Weeks pointed out clearly that Astin was not rehired. "No question is involved of Dr. Astin's permanent retention," he emphasized. Astin's was to be essentially a resignation, but without an effective date. Stating that his difference with Astin arose from a "conflict with respect to administrative viewpoint and procedure," he said that his actions were not intended to "cast reflection on the integrity of the Bureau or on the professional competence or integrity of Dr. Astin." Weeks' announcement was further softened by his promise that Astin would be offered a job at his present grade in the Government "where his abilities . . . may be utilized in the national interest." Astin, in turn, accepted his position "regardless of my personal opinions or wishes," despite the fact that he could not act officially as director.<sup>129</sup> A lull had been brought into the turbulent situation.

Reported nationwide, the announcement was viewed as a notable retreat for Weeks, and as a great victory for the scientific establishment. The scientific community was, however, more restrained. For them, the matter was not closed. Astin was still in an ill-defined situation, and the position of science in the Government needed to be clarified. "More is needed to undo the harm that has been done," stated the Council of the American Physical Society, and David Hill, chairman of the Federation of American Scientists, announced in a press release, "Until it is made clear . . . that . . . [subordination of scientific activities to non-scientific pressures] is not operative . . . the damage resulting from the Astin affair will continue to spread."<sup>130</sup>

---

<sup>128</sup> Lawrence, *Battery Additive Controversy*: 24.

<sup>129</sup> Federation of American Scientists, "Statement by Secretary of Commerce Sinclair Weeks, April 17, 1953," *FAS Newsletter*, April 17, 1953; Federation of American Scientists, "Statement by Dr. A. V. Astin, April 17, 1953," *FAS Newsletter*, April 17, 1953. (NARA; RG 167; Astin file; Box 6; Folder 0/946 Battery Additives)

<sup>130</sup> David L. Hill, "Statement on Postponement of Astin Dismissal." Federation of American Scientists, press release, Saturday, April 18, 1953. (NARA; RG 167; Astin file; Box 6; Folder 0/9.46 Battery Additives)

## THE SENATE HEARINGS

On Monday, June 22, 1953, the Senate Select Committee on Small Business recommenced the hearings that had been held in abeyance during the public uproar following the appearance of Weeks and Sheaffer on March 31. They were to last through June 26. The principal testifiers were Ritchie, Astin, and Weber, but twelve other witnesses—six of whom were from military installations, and all but one of whom were proponents of AD-X2—testified. In his opening statement on the second day of the hearings, Senator Thye stated the purpose of the hearings:

The issue which we are trying to resolve in the interest of the business, the Government, and the economy of our Nation can be simply stated. That issue is whether or not agencies of the Government have been fair and just in the treatment of Mr. Ritchie and his product, Battery AD-X2. . . .

[W]e sincerely hope that a complete presentation of the facts . . . will assist the public, the agencies of the Government, and this committee to solve the issues as I have stated them.<sup>131</sup>

No such solution was ever to be achieved by the committee. Thye went on to point out that there was a suspended fraud order against Ritchie, and “[t]his order in fairness to all parties, should not be allowed to be held in abeyance indefinitely.”

The first witness to testify was Ritchie. A voluble, somewhat rambling witness, he testified for more than five hours, running into Tuesday afternoon. Before a generally friendly committee, he gave his account of the history of the incident, and particularly his problems with the Bureau: how he got into the battery additive business; his discovery with Randall of AD-X2; how he had slowly built up his business; the large numbers of satisfied customers; the effect of Letter Circular 302, Circular 504, and the bulletins of the NBBB based on Bureau statements; his difficulty in getting the Bureau to test his product while all the time lumping it with all others for condemnation; the blunders the Bureau made when it did test it; and the disastrous effect Bureau publications had on his business. With a great deal of participation from many of the senators, it was effective testimony.

Not every senator, however, was completely friendly. In particular, Hubert Humphrey of Minnesota, who was trained as a pharmacist and hence knew chemistry, caused Ritchie some problems when discussing the composition of AD-X2 and its progenitor, Protecto-Charge. An almost humorous exchange occurred near the beginning of the testimony:<sup>132</sup>

SENATOR HUMPHREY: (ostensibly quoting from the original Randall letter to Vinal) “Its [Protecto Charge] composition is a mixture of anhydrous sodium sulfate, commonly known as glauber salt, and slightly basic, nearly anhydrous magnesium sulfate, epsom salt.”<sup>133</sup>

<sup>131</sup> AD-X2 Hearings: 9.

<sup>132</sup> J. M. Ritchie testimony, AD-X2 Hearings: 21-27.

<sup>133</sup> This sentence does not appear in the Randall letter.





On June 22, 1953, Jess M. Ritchie demonstrated AD-X2 before the Senate Select Committee on Small Business. (AP-Wide World Photos)

MR. RITCHIE: You are quoting Dr. Randall?

SENATOR HUMPHREY: I surely am.

And, after two more questions:

MR. RITCHIE: Senator, Dr. Randall never wrote "epsom salt" and "glauber salt" in any letter to anyone, I am sure.

SENATOR HUMPHREY: He wrote "anhydrous sodium sulfate" and "anhydrous magnesium sulfate." Anybody who has had the first year of college chemistry knows that one of those is glauber salt and one is epsom salt. One of them you give to horses and one to people; that is right, is it not?"

MR. RITCHIE: I am not a veterinarian.

SENATOR HUMPHREY: I have taken chemistry. I am a pharmacist. Now, I happen to know that you give glauber salt to animals and epsom salt to people. One is magnesium sulfate and one is sodium sulfate. Everybody knows that.

The exchange continued and developed into a question of impurities, trace elements, and secret ingredients in AD-X2.

MR. RITCHIE: The salts in this material do not appear as epsom salt or glauber salt.

SENATOR HUMPHREY: It is anhydrous sodium sulfate.

MR. RITCHIE: Slightly basic.

SENATOR HUMPHREY: That means that it has slight traces of impurities.

MR. RITCHIE: That is the key to the thing.

And a little later:

MR. RITCHIE: Now these impurities, these trace elements that are in battery AD-X2—

SENATOR HUMPHREY: What do you mean by “trace elements” that are supposed to have some peculiarities of bringing back electrical or new powers to a battery? What are these trace elements?

MR. RITCHIE: There are a number of things. There is silver, some that are added—

SENATOR HUMPHREY: Do you have a list of the trace elements?

MR. RITCHIE: I would rather not disclose them, Senator, because I believe that no man has a right to give away a secret formula.

And despite intense further questioning by Humphrey, who pointed out that any skilled chemist could identify all the trace elements, Ritchie would disclose no more on the topic of secret ingredients. Ritchie had portrayed himself as the backyard inventor who had discovered a miracle formula and was not about to divulge it. It was a skillful performance.

Ritchie was followed by Astin on the witness stand.<sup>134</sup> His appearance, lasting about eight hours, began with a long prepared statement that occupied almost twenty pages in the hearings transcript. In it Astin laid out the functions and activities of the Bureau and how they arose from its enabling legislation. He described how small the part commodity testing was in the whole program, and how the enabling legislation authorized the publication of material of interest to the general public. He then described the Bureau’s testing program and the development of test methods, the essential role of controls when determining the effect of “some modification in the treatment or handling process on the behavior characteristics of the material or device under investigation.” He went into field tests in the development of new ordnance devices (where the Bureau, and Astin personally, had great experience), pointing out that “the field test . . . is not resorted to until some improvement or effect is developed in the laboratory which would . . . make the field tests worthwhile.” He then recounted the Bureau’s version of the AD-X2 affair, from the receipt of Randall’s first letter through the MIT tests and the Bureau’s rationalization of those results. With respect to the Bureau’s permission to have the NBBB publish Bureau statements making specific reference to AD-X2, Astin testified, “This deviation from the usual practice was at the request of the National Better Business Bureau in order to reply to statements made by the proponents of AD-X2 that the generalization made in prior

---

<sup>134</sup> A. V. Astin testimony, AD-X2 Hearings: 214-221.

bulletins did not apply to that product and that it had not been tested by the Bureau,” and a little later, “every action which the Bureau has taken with respect to the testing of AD-X2 and the dissemination of information with respect thereto has been brought about as a direct consequence of the representations and pressures of the proponents of AD-X2.”

In his prepared testimony, Astin addressed the question of the publication of scientific results:

A laboratory study on the properties of aluminum under a particular set of environmental conditions might disclose characteristics for aluminum superior to those of steel under the same set of environmental conditions. The publication of such data would not be considered as prejudicial to those interested in promoting the use of steel; rather the withholding of such data would be considered prejudicial to the interests of the general public and those interested in promoting the use of aluminum. In science and technology a specific, reproducible observation is a fact that knows no favorites.

The statement appears to be a reply to Weeks’ “play of the marketplace” before the committee. Clearly, Astin saw the function of science as the discovery and dissemination of scientific truth, with no regard for political or other consequences. Science did not make policy; that was left to others, which might include scientists. But scientific truth was inviolate. In the AD-X2 affair, one of the first times that the paths of science and public policy crossed, things seemed relatively simple. In later years and in other settings, the discovery of scientific truth would not seem so easy.

Astin did not lack for cross-examination.<sup>135</sup> He was grilled about the letters to the NBBB which seemed to ask the NBBB’s advice on what to publish, and perhaps even suggesting that the FTC be brought into the AD-X2 matter; about the Bureau’s relations with industry; and about the Bureau furnishing information, in which the name of AD-X2 was used, to the NBBB and permitting them to make the information public. But foremost was the topic that concerned the whole Committee—how there could be so many satisfied users of AD-X2 and the Bureau not find merit in it. Chairman Thye returned to it several times. A typical exchange went as follows:

CHAIRMAN THYE: But the simple truth of the question is that if a good, hard-fisted businessman has used the product in a fleet of motors and in the batteries serving those motors over a number of years and is fool enough to come up and place orders month after month, what is the matter with him? Or otherwise, what is the matter with the Bureau of Standards test?

Now, that is the question, sir.

DR. ASTIN: The man with his fleet of cars might have some real data to debate on if over a rather long period of time he put the material in half the batteries of his fleet and took pains to make sure that each half of the fleet had roughly the same use conditions, and then checked them monthly. On that basis, it would mean something.

---

<sup>135</sup> Ibid., 227-332.

Many such exchanges occurred with Thye and other senators, with Astin always iterating that results without controls meant nothing, scientifically speaking, but it was not clear that he convinced any of the skeptical senators. The gulf separating the scientific and political arenas was not easily bridged.

One of the most interesting exchanges occurred with Senator Homer Ferguson on the question of the Bureau's acting as a regulatory agency. Ferguson grilled Astin deeply on many points, particularly on the question of the Bureau having done testing for the NBBB, but then he came to a question about the Bureau acting tacitly as a regulatory agency:

SENATOR FERGUSON: I am concerned with the possibility that the National Bureau of Standards may become—may be used as a regulatory body of proprietary products. Do you think that is possible with what has happened in this case?

DR. ASTIN: Well, first, we do not have any regulatory authority or responsibility, but we do—

SENATOR FERGUSON: Well, you can regulate pretty well through the Post Office fraud order, can you not?

DR. ASTIN: That is not our initiative, sir. All we try to do is to assist them on a technical problem.

SENATOR FERGUSON: I say you can, though—you can have cooperation between the Post Office and your Department or the Federal Trade, and you can do pretty well on regulation, can you not?

DR. ASTIN: I don't know how we could take any responsibility for the regulation when that belongs to them. We try to give them technical information to help them, but they are doing the regulating, not us.

SENATOR FERGUSON: Then, you would say that you do not think it ought to be denominated a regulatory body?

DR. ASTIN: We don't want to be a regulatory body; we are a fact finding organization.

Later Senator Ferguson returned to the topic:

SENATOR FERGUSON: Do you think the National Bureau of Standards by following its policy of disseminating technical data, when not specifically directed toward scientific or technological progress, at the professional and production level, is broadening gratuitously and, perhaps inadvertently, into a regulatory activity?

DR. ASTIN: Indirectly it might be so construed, but—

SENATOR FERGUSON: Would it not be, as a matter of fact, a regulatory activity? Isn't that what this has amounted to?

DR. ASTIN: Well, one can extend that and say that, similarly, all progress in science and technology is regulatory. The invention of the incandescent lamp bulb made obsolete gas lights and so on, so that if you carry this too far, then you would never disseminate any scientific information because it might have some effect on curtailing the marketing of some products that it is related to.

Astin's analogy was not an exact one, but the question was not pursued. It was clear, however, that no one wanted the Bureau to act like a regulatory agency—with or without authority.

In spite of all the reservations on the committee, it is quite clear that the members were ready to think well of the Bureau as well as Astin, whom they admired at least as a solid professional in the Civil Service, and who had stood up well under his current difficulties. Thus, near the end of his testimony the following exchange occurred:

SENATOR SMATHERS: Now, just one last question, prompted by my good friend, the Senator from Kansas, about the relative worth of the product aspirin as compared to the relative worth of AD-X2, in your offhand opinion do you think that the value of aspirin had been proved and established more so than the value of AD-X2?

DR. ASTIN: I buy aspirin.

SENATOR SMATHERS: No further questions.

SENATOR SPARKMAN: In considerable quantity?

SENATOR HUNT: Lately?

THE CHAIRMAN: Doctor, I hope we weren't the cause of you buying any.

DR. ASTIN: I have got a great big 85-grain tablet that I keep in my desk. It is National Bureau of Standards size.<sup>136</sup>

Weber, the third of the principal witnesses, testified on the morning of July 25, 1953. His testimony was relatively short, perhaps caused by the fact that he was unwilling to make any evaluation of AD-X2. His prepared statement was:

It is the position of the MIT group that no conclusions can definitely be drawn as to the commercial utility of AD-X2 or lack of it, based on the MIT experiments, and that the drawing of definite conclusions based on limited laboratory experiments as to the commercial utility of AD-X2 is not justified.<sup>137</sup>

Under questioning from Senator Sparkman, he also agreed with the statement of Beattie about the lack of correlation of the MIT results with the "normal use of such a battery."

Finally, concerning Laidler's analysis of the MIT results in the SSBC press release, the exchange went as follows:

SENATOR SPARKMAN: Dr. Laidler's statement was made an appendix to [the press release].

DR. WEBER: Yes, I have read that part.

SENATOR SPARKMAN: All right. Was that, in your opinion, or was it not a fair interpretation?

DR. WEBER: It was not my opinion. He expressed an opinion of his own.<sup>138</sup>

<sup>136</sup> A. V. Astin testimony, AD-X2 Hearings: 330-331. Eighty-five grains is 5000 milligrams. The normal aspirin tablet is 325 milligrams. The tablet (there are actually two) and a Lucite-encased box of AD-X2 were traditionally handed down from director to director. They are now in the NIST Museum collection.

<sup>137</sup> H. C. Weber testimony, AD-X2 Hearings: 372.

<sup>138</sup> *Ibid.*, 393.

Weber's testimony effectively ended consideration of the MIT tests, at least in the political arena. The staff of the SSCSB had suffered a great loss of face.

Of the remaining twelve witnesses, only one—James C. Beene of the Kelly Air Force Base in San Antonio—testified against AD-X2, saying he would not buy any for his own use. The others—with various degrees of enthusiasm—testified to its effectiveness, prompting the committee to request that the Department of Defense and the Navy “resume testing it for use in submarine batteries.”<sup>139</sup>

The hearings concluded abruptly at midday on June 26. Other witnesses, including Laidler, were to have been called, but they were not.

### THE INCIDENT WINDS DOWN

It was clear with the end of the hearings that the denouement of the AD-X2 incident had passed. On the political front, nothing happened. Aside from the already mentioned recommendation about the investigation of AD-X2 for use in submarine batteries, and a letter to the Post Office Department recommending the removal of the suspended fraud order against Ritchie, the committee did nothing, although it did issue an annual report of its activities, part of which covered the AD-X2 hearings. Despite pertinent questions it had raised during the hearings about the Bureau's possible tacit and inadvertent behavior as a regulatory agency; about the Bureau's relations to industry and the National Better Business Bureau; about the possibility that a businessman who gave the impression of being honest and dedicated had all but been forced out of business by the Government; and other questions and issues, the committee did not initiate nor recommend any legislative action. Perhaps this came about because it was a select committee that had no legislative authority. And, possibly because of the hurried adjournment, it did not even have a closing statement. Perhaps the issues raised and discussed were too ill-defined, too vague to permit a resolution.<sup>140</sup> Whatever the reason, the AD-X2 incident was over on the political front, and the only further contact between Ritchie and the Bureau was to come across the table at FTC hearings.

But if the climax had passed, there were still events that had to transpire before the incident, let alone its aftermath, can be said to have ended. In particular, the two regulatory agencies—the POD and the FTC—still had unfinished business to transact, and the Bureau had two committees investigating it. And it had a director who was in some kind of limbo from which he had to be released. For both the Bureau and Ritchie, important events were still to take place.

<sup>139</sup> Lawrence, *Battery Additive Controversy*: 26.

<sup>140</sup> Library of Congress, Legislative Reference Service, “AD-X2: The Difficulty in Proving a Negative,” chapter 3 in *Technical Information for Congress: Report to the Subcommittee on Science, Research, and Development of the Committee on Science and Astronautics, U. S. House of Representatives, 91st Cong., 1st sess., 25 April, 1969.*

## THE POST OFFICE DEPARTMENT AND THE FEDERAL TRADE COMMISSION

At the close of the hearings, the POD fraud order on Pioneers was still in effect, albeit suspended. But the postmaster general was quick to act. On August 20, 1953, somewhat less than two months after the hearings, he cancelled the fraud order.<sup>141</sup> The release reads:

Since the original hearings conflicting scientific testimony of competent authorities and the statements of satisfied users have been presented to the Senate Committee on Small Business.

A scientific evaluation is now being conducted under the auspices of the Department of Commerce.

In view of these circumstances the fraud order is cancelled.

In more detail, the release explains that the postmaster general had considered the original letters by Thye and Weeks, the transcript of the hearings before the SSBC, and a letter on July 15 from Weeks. On the basis of this evidence, the POD reached the conclusions that:

(A) There is a substantial disagreement as to the relative benefits of AD-X2.

(B) That the Department of Commerce has authorized further study and investigation of the merits of battery additives.

(C) That based upon all of the evidence, that is to say, the evidence introduced in the original proceeding, together with the evidence introduced subsequent thereto in support of respondents' motion, there is insufficient proof of an actual intent by Ritchie to deceive which is required to warrant and maintain a fraud order.

Matters before the FTC were not so quickly resolved.<sup>142</sup> It had not acted since its original investigation in 1951 and, despite some pressure from the press, did not act until 1954, when, on March 11, it charged that Pioneers used "false, misleading and deceptive claims, statements, and representations." Hearings began in Washington on July 26 and ended for the Bureau with rebuttal testimony on September 22. Then, in order to obtain user testimony, hearings were held in thirteen different cities throughout the country. The hearings dragged on through 103 sessions until November 9, 1955, when the hearing examiner ruled in favor of Ritchie. The examiner found that the user testimony counterbalanced the scientific evidence, and the commission's lawyers had not met the burden of proof.<sup>143</sup>

The decision was appealed by the commission attorneys as well as Ritchie, who felt that the examiner's decision was in part favorable to the Bureau. Finally, on May 16,

<sup>141</sup> Post Office Department, Release No. 977, August 20, 1953.

<sup>142</sup> Lawrence, *Battery Additive Controversy*: 29-31, gives a detailed discussion of the hearings before the FTC. The first part of the account presented here is a shortened version of that discussion.

<sup>143</sup> *United States of America Before Federal Trade Commission, In the Matter of Pioneers, Inc., and Jess M. Ritchie, Initial Decision*, by William L. Pack, *Hearing Examiner*, November 9, 1955, Docket No. 6190.

1956—more than eight years after Randall's initial letter to Vinal—the full commission dismissed the complaint against Ritchie.<sup>144</sup> It was a great victory for him.

But Ritchie tried to go further. He began advertising that his product had been approved by the FTC and had been Government tested and approved, whereupon the FTC brought another complaint against Ritchie. This time he lost. On September 7, 1960, he was ordered to cease and desist.<sup>145</sup>

And Ritchie had other dealings with the Government. On July 20, 1956, Congressman John J. Allen, Jr., of California introduced a bill to pay Pioneers an unspecified sum of money "in full settlement of all claims . . . for compensation for losses . . ." <sup>146</sup> This bill was not passed, but a following Congressional Resolution permitted Ritchie to sue the Government.<sup>147</sup> He did so—for \$2.4 million. When he saw the defendant's (i.e., the Department of Justice's) case at a pretrial conference, Ritchie asked for dismissal. In December, 1961, the case was dismissed with prejudice; Ritchie could not reopen it. Astin commented, "I am advised that this is the first time that a suit referred to the U.S. Court of Claims by the Congress has been dismissed with prejudice."<sup>148</sup> This action may be termed the last event in the AD-X2 incident.<sup>149</sup>

## THE BUREAU

Of the various institutions involved in the AD-X2 incident, the Bureau was the most affected. The first event to occur after the hearings was a pleasant one. On August 22, 1953—just two days after the POD order—the AD-X2 affair, which had become a running story in the press ever since Astin's dismissal, erupted once again into headlines. "Astin Keeps Job—Weeks," shouted a *Washington Times-Herald* headline. It and newspapers throughout the Nation were reporting a six-page news release from the Department of Commerce on the previous day announcing that Weeks had decided to reinstate Astin.<sup>150</sup> The release said that Weeks was taking Astin back as "a member of my team" for the "best interests of the Bureau and the public."

<sup>144</sup> Federal Trade Commission, *In the Matter of Pioneers, Inc., and Jess M. Ritchie, Opinion of the Commission*, by Anderson, Commissioner, May 16, 1956, Docket No. 6190.

<sup>145</sup> Federal Trade Commission, *In the Matter of Pioneers, Inc., and Jess M. Ritchie, Decision of the Commission and Order to File Report of Compliance, Initial Decision*, by Walter R. Johnson, Hearing Examiner, September 7, 1960, Docket No. 7844.

<sup>146</sup> Congress, House, *A Bill for the Relief of Pioneers, Incorporated, a corporation, and Jess M. Ritchie, individually, and as an officer of said corporation*, 84th Cong., 2d sess., HR 12333.

<sup>147</sup> Congress, House, *Resolution Providing for Sending the Bill H.R. 3875 and Accompany Papers to the United States Court of Claims*, 85th Cong., 2d sess., H. Res. 167.

<sup>148</sup> U.S. Department of Commerce, "Statement by A. V. Astin, Director, National Bureau of Standards," December 15, 1961, National Bureau of Standards TRG-6277.

<sup>149</sup> "AD-X2: The Case of the Mysterious Battery Additive Comes to an End," *Science* 134 (1961): 2086.

<sup>150</sup> U.S. Department of Commerce, "Statement of Secretary of Commerce Sinclair Weeks," Saturday, August 22, 1953. G-394-A.



What seemed like a sudden decision had not been made so hastily. Weeks had asked the Bureau's Visiting Committee to suggest a list of candidates for the position of director, and the committee unanimously urged the retention of Astin.<sup>151</sup> The press release went on to quote Weeks that the AD-X2 incident "obscured the real problem." His major concerns were:

1. Serious lack of balance in the programs of the Bureau.
2. Imperfections in the system of evaluating commercial products.
3. Inadequacies of organization and administrative control.

Rather than a vindication, Astin said he would prefer to term Weeks' action as "a sincere change of mind on the part of the Secretary of Commerce."<sup>152</sup> In fact, Astin's scrupulously correct behavior toward his superiors, his willingness to follow orders, his understanding of the reason behind his dismissal, and most of all his lack of rancor, were probably instrumental in changing Weeks' mind. The release went on to quote heavily from the as-yet unreleased report of the evaluation committee under Dr. Mervin Kelly which agreed with his analysis and detailed it.

Of significance for the Bureau was the announcement in the press release that it was to be removed from the jurisdiction of Sheaffer and placed under Assistant Secretary for Administration James C. Worthy, who had strongly opposed Astin's dismissal. On September 15, Sheaffer resigned. And, in a result that could hardly have been anticipated after his actions upon taking office, Weeks went on to become a strong supporter of Astin and the Bureau.

The lives of the Bureau scientists working directly in the AD-X2 affair were not made materially easier by the winding down of the incident. While there was no longer a direct confrontation with Ritchie on the scientific front, there was a remaining battle on the legal front. Many of them had to testify at the FTC hearings and were vigorously—even brutally in the memory of some of the participants—cross-examined by Ritchie's lawyers.<sup>153</sup> The lives of some of them were irrevocably changed by the experience. All the battery scientists were also kept busy supplying information, both oral and in writing, to the two committees studying the Bureau and the AD-X2 incident. And they kept going the comparison experiments that were the basis of the "public test." The experiments were finally shut down in the fall of 1953. They gave no reason for the Bureau to change its mind.

## THE COMMITTEES REPORT

Even as the hearings were taking place, the two committees—one to evaluate the functions and operations of the Bureau and the other to evaluate its work on AD-X2—formed at Weeks' request by the Bureau's Visiting Committee and the National Academy of Sciences, were doing their work.

<sup>151</sup> Ibid, 5.

<sup>152</sup> "Weeks Puts Astin Back As Director of Bureau," *Washington Post*, August 22, 1953: 1.

<sup>153</sup> The Bureau participants in the FTC hearings were Allen V. Astin, Bruce B. Bendigo, Robert L. Cottingham, D. Norman Craig, Paul C. Donnelly, Churchill Eisenhart, Walter J. Hamer, Cyrus G. Malmberg, Bourdon F. Scribner, and Clarence L. Snyder.

The first of these, commonly called the Kelly Committee after its chairman, was the first to report.<sup>154</sup> Indeed, it reported orally to Weeks continually as it was doing its work, and Weeks acted on those verbal recommendations before receiving a final report. In fact, his press release reinstating Astin was largely based on the committee's recommendation.

It can be fairly said that no other single report has had as great an effect on the history of the Bureau as the "Kelly Committee Report," as it is commonly known. It can be said that its influence came about as much from its philosophy of the Bureau's nature and role as from the specific recommendations it made. With respect to philosophy, the words were welcome to the Bureau:

It is the Committee's considered judgment that our highly industrialized society requires a Bureau of Standards that is the finest that can be created. To the extent that the Bureau is weak or inadequate, our technologic society is handicapping itself. By the very nature of its functions the Bureau's work must not be "reasonably good," it must be superior. It is not sufficient to have fairly good standards of measurement; fairly good methods of testing materials, mechanisms or structures; or reasonably good determination of important physical constants. The standards, the measurements, the test procedures must be the very best, the most accurate, the most reliable that can possibly be achieved at any given time, limited only by the state of the art at the time. It is thus more than a play on words to say that the "standards" by which the Bureau is judged must be the very highest and best.<sup>155</sup>

With respect to recommendations, the committee found "the volume of weaponry work has become large in comparison with all other activities of the Bureau. Its relative size and its effect on the other Bureau programs make its transfer from the Bureau desirable." Hence it recommended the "transfer of weaponry projects to the Department of Defense," but recommended "continued use of the Bureau by Department of Defense and Atomic Energy Commission for non-weaponry science and technical aid." Following these recommendations, on September 27, 1953, four ordnance divisions, totaling 2000 persons—1600 in three divisions at the Harry Diamond Ordnance Laboratory in Washington, and 400 at the Missile Development

---

<sup>154</sup> *A Report to The Secretary of Commerce by the Ad Hoc Committee for the Evaluation of the Present Functions of the National Bureau of Standards: A Report on the Present Functions and Operations of the National Bureau of Standards With Their Evaluation in Relation to Present National Needs and Recommendations for the Improvement and Strengthening of the Bureau*, October 15, 1953. The members of the committee were: Mervin J. Kelly, Chairman, President, Bell Telephone Laboratories; Lee A. DuBridge, President, California Institute of Technology; William L. Everitt, Dean of Engineering, University of Illinois; James W. Parker, President, Detroit Edison; Kenneth S. Pitzer, Dean, College of Chemistry, University of California; J. Barkley Rosser, Professor, Cornell University; Guy Suits, Vice President and Director of Research, General Electric; Clyde Williams, President, Battelle Memorial Institute; and Abel Wolman, Professor, Sanitary Engineering, The Johns Hopkins University.

<sup>155</sup> *Ibid.*, 4.

Division in Corona, California—were transferred to Army Ordnance and Naval Ordnance respectively, although all operations remained at their respective sites. The transferred operations were the total of the Bureau programs in proximity fuzes and guided missiles. Eventually, in 1973, the ordnance work carried out at the Van Ness site was moved to newly constructed ordnance facilities in Adelphi, MD.<sup>156</sup>

Another recommendation that was quickly adopted was that of having advisory committees, each appointed by a specific scientific or engineering society, review each operating unit of the Bureau yearly and report their findings to the director. This recommendation was quickly implemented, and the life of a middle-manager at the Bureau would never again be the same.

A fourth recommendation was meant to insulate the Bureau from political pressures and have it work only in the scientific arena, where its competence lay. The committee recommended “Division of primary responsibility for policy and procedures on commercial product tests between the Secretary of Commerce and the director of the Bureau.” The Bureau would eventually give up its commercial product testing. But perhaps the most important recommendation it made was based on the finding:

Since the close of the war the technology of the Nation has shot rapidly forward. The Bureau’s basic programs expanded until 1950 but at a rate beneath that justified by the needs. Since 1950 the decrease in basic programs must be considered as tragic. The ground lost since 1950 should be regained in the next two fiscal years and the programs then expanded as detailed studies by the Director and his advisory committees find necessary.

This led to the starkly simple recommendation of “higher level of activity in the basic programs.” These recommendations, and five others the committee made, were to provide a course of action for at least the near-term future of the Bureau, and an agenda for Director Astin.

The second committee, with Zay Jeffries as its chairman, was formed to evaluate the Bureau’s work on battery additives. The Jeffries Committee Report, while not as causative of change at the Bureau as was that of the Kelly Committee, was perhaps even more welcome to the Bureau battery scientists and all others who had been involved in the technical aspects of the AD-X2 affair.<sup>157</sup> They were kept busy providing

---

<sup>156</sup> MFP, 497. The Harry Diamond Ordnance Laboratory was comprised of the Ordnance Electronics, Electromechanical, and Ordnance Development Divisions. Named in 1949 for the guiding force in the Bureau’s ordnance research, it was renamed the Diamond Ordnance Fuze Laboratories upon its transfer in 1953 to the Army. Missile development became the Naval Ordnance Laboratories (Corona) upon its transfer to the Navy.

<sup>157</sup> National Academy of Sciences, *Report of the Committee on Battery Additives of the National Academy of Sciences*, October 30, 1953. The members of the committee were: Zay Jeffries, Chairman, Vice President (Retired), General Electric Company; Elmer K. Bolton, Director of Chemical Department (Retired), E. I. du Pont de Nemours and Co.; William G. Cochran, Professor of Biostatistics, The Johns Hopkins University; J. P. Fugassi, Professor of Physical Chemistry, Carnegie Institute of Technology; John G. Kirkwood, Professor of Chemistry, Yale University; Victor K. LaMer, Professor of Chemistry, Columbia University; Lewis G. Longworth, Member, Rockefeller Institute for Medical Research; Joseph E. Mayer, Professor of Physical Chemistry, University of Chicago; Fred E. Terman, Dean, School of Engineering, Stanford University; and Samuel S. Wilkes, Professor of Mathematical Statistics, Princeton University.

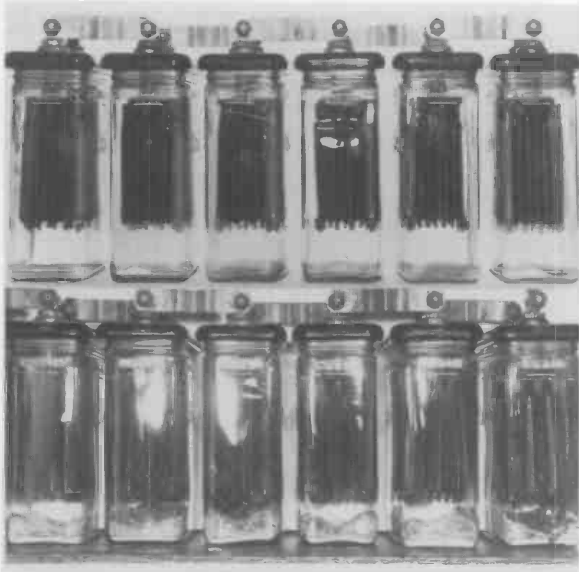

In July 1953, at the request of the Jeffries Committee, six lead-acid batteries used as part of the d-c power supply at NBS were randomly selected for inclusion in a test of a battery additive (top). Three of the cells were treated with additive, three were not, and all six were placed back in routine service. After 10.5 years the treated cells (second, third, and sixth, left to right bottom) showed more deposit and their averaged electrical capacity was but 3.5 percent of the untreated cells.<sup>158</sup>

the committee with written reports and oral briefing, but the result was gratifying. After examining “the statements made by the Bureau relating to AD-X2,” judging “the quality of the Bureau’s work in the field of lead acid storage battery testing,” and studying “the claims made for Battery AD-X2 and the scientific evidence developed to date in support of those claims,” the committee came to its conclusions. It found:

1. that the quality of the work of the National Bureau of Standards in the field of lead acid storage battery testing is excellent, and
2. that while Pioneers, Inc., claims that AD-X2 has substantial merit, the relevant data now available to the Committee on the effects of AD-X2 are adequate to support the position of the Bureau of Standards that the material is without merit.

The committee made a single recommendation to the Bureau: “The Committee recommends that no additional tests on the merit of AD-X2 be undertaken by it [the Bureau] or under its supervision.” The Bureau’s work had been vindicated by the Nation’s highest scientific authority. While the staff could not forget AD-X2, they could at least go on to work on something else.

## CONCLUSIONS

Comparison of the Aquella and AD-X2 incidents shows similarities and differences with respect to adherence to Bureau policy and the resulting effects. In the Aquella case, there were possible oversights that caused a Bureau report naming a proprietary product to become public, something that policy was designed to prevent. This led to embarrassment for the Bureau, and a temporary period in which the proponents of Aquella were able to use the Bureau’s results in advertising purposes. In the AD-X2 incident, the Bureau did everything in accordance with its policy, yet the result was far

<sup>158</sup> “Battery Additive—Findings of an In-House Field Experiment,” *Technical News Bulletin* 54 (April 1970): 81.

greater—if not permanent—trauma for the Bureau. There was evidently an Achilles' heel in publishing the results of commodity testing, and this weakness was exploited brilliantly by an aggressive, persistent, and politically astute entrepreneur. As a result, a period of extensive change for the Bureau was initiated. That this change might very well have happened even without the AD-X2 incident is immaterial; the incident was the catalyst of change.

The weakness surfaced with the testing of a class of materials that met two rather stringent conditions. First, a large number of proprietary products had to fit in the class, and the Bureau needed to have tested many. Irrespective of the test results, the Bureau, following its policy as enunciated by Astin that "withholding . . . such data would be considered prejudicial to the interests of the general public,"<sup>159</sup> had reason to issue a publication notifying the general public of its findings on the class of materials, not on specific products. Second, the materials—sodium and magnesium sulfates in the case of AD-X2—had to prove to be neither beneficial nor detrimental, but "ineffective." In publishing this statement, however, it put itself in the awkward, if not impossible, scientific position of having to prove a negative. A manufacturer could claim that his product differed from the general class, as Ritchie did, and refuting those claims was difficult. Finally, there had to be something about the product or the mode of selling that led to satisfaction among many users, so that testimonials could be provided. Under these conditions, the Bureau's position was untenable, and Ritchie exploited it.

Inevitably one seeks to find winners and losers in incidents of this type. In the Aquella incident, there were no clear-cut winners, and both sides were clear-cut losers. The proponents of Aquella, victorious for a while, were eventually found at fault by the FTC, while the Bureau suffered serious embarrassment. Deciding on winnings and losses in the AD-X2 incident is much more difficult. Both sides suffered considerable trauma during the height of the incident. Some persons—O'Connor, Sheaffer, and Laidler—had damage done to their careers. Ritchie claimed that the whole incident cost him more than \$2 million, and the time and effort spent by the Bureau has never been calculated, but was many man-ears.

But in another sense, both sides were winners. At the end of the incident, Ritchie still had his business, and was in a stronger position than at the beginning. His advertising had been cleared by the FTC and the POD, and he could rightfully claim that he had taken on the whole Government and won. In fact, he liked the whole political game so well that he ran for Congress, but he lost.

The Bureau was also stronger at the end of the affair, and in this sense was a clear-cut winner. In the person of Astin, it was looked upon by the scientific community as a heroic champion in the preservation of scientific freedom and integrity against attempts at Governmental control. Astin himself was in a formidable position, stronger than any director before or after him. And the Bureau had been investigated by two high-level committees, one which found its work impeccable while the other gave it a welcome agenda for the future. Perhaps the results made the trauma of the whole episode worthwhile.

---

<sup>159</sup> A. V. Astin testimony, AD-X2 Hearings: 214.

Larger segments of the Nation are more difficult to analyze. In politics nothing happened; no legislation was passed. But another segment of society was clearly affected. The whole Nation had learned that the scientific community was a force to contend with, and in this sense science was a winner. But in the legal arena, it is not clear that science won. Indeed, it could be argued that in this arena science was a loser. At both the FTC and the POD, its results were weighed against testimonials that had no scientific basis, and the two were found to be of equal weight.



The first instruction on the back of each AD-X2 package, to clean the top of the battery and posts, is good battery maintenance procedure. Perhaps it was the reason for the satisfied users of AD-X2.

A question that was never answered by the Bureau, or anyone else, was how AD-X2 could have had so many satisfied users. Perhaps what should have been considered was not only the effect of the chemicals found in an envelope. Pioneers, after all, sold a total package, and this consisted of a chemical powder and a set of instructions. No one ever said that the instructions were poor. In fact, they were good, and it is entirely possible that under pressure of the money paid for the package, a consumer would follow the instructions carefully, achieving good results, and never realize that the same results could have been obtained by following the directions and forgetting about the white powder. Perhaps this strange, non-ending, convoluted affair was decided correctly in the legal arena after all.

---

## CHAPTER THREE

---

### DIVESTITURE AND REAFFIRMATION, 1950-1957

The early years of the decade of the fifties were turbulent years for the Bureau. By the time the decade was one-third over, one director, under attack from the House Un-American Activities Committee and distressed by the rising wave of McCarthyism, had resigned; the trauma of the battery additive incident had occurred with the firing and eventual re-hiring of the following director; the Korean War, which had increased the Bureau's size to the largest in its history, almost caused it to lose its identity as the Nation's measurement standards laboratory; and the Bureau had to rebuild its basic program while its base appropriation was declining disastrously. It was, at one and the same time, rich in money for work for other agencies, while poor in funds to carry out the work it was legally mandated to do at a time when the explosive postwar growth of science called upon it to do more. Yet it was able to surmount these problems, and by the last quarter of the decade it was on the road to some of the happiest and most productive years in its history. In many ways its history in this decade mirrored the history of the Nation.

#### A PLACID NATION

The general view of the decade of the 1950s is of a time of public obsession with suburban homes, barbecues in the back yard, tail-finned automotive behemoths, TV, rock music, and babies. In the words of columnist Robert J. Samuelson:

You know the rap against the fifties. Nothing happened. Ike golfed, Elvis sang, cars sprouted tail fins, and students belonged to the "silent generation." Dullsville.<sup>1</sup>

But the view observed depends on the viewpoint. Historian Elaine Tyler May writes:

Diplomatic historians paint one picture of a world torn by strife and a stand-off between two superpowers who seemed to hold the fate of the globe in their hands. Sociologists and demographers provide a different picture of a private world of affluence, suburban sprawl, and the baby boom.<sup>2</sup>

Whatever the viewpoint, the beginning of the decade was anything but placid. On Saturday, June 24, 1950, North Korea invaded South Korea in force and immediately began to push back the South Korean forces. Events unfolded at breakneck speed.

---

<sup>1</sup> Robert J. Samuelson, "The Deceptive Decade," *Washington Post*, February 28, 1990.

<sup>2</sup> Elaine Tyler May, *Homeward Bound: American Families in the Cold War Era* (New York: Basic Books, 1988): 10.





Five tons of supplies for an isolated U.S. Air Force radio station in Korea drifted toward the target after being dropped by a C-119 Flying Boxcar of the 315th Air Division. In FY 1952, during the Korean War, 80 percent of the Bureau's budget came from the military. (Photo courtesy of U.S. Air Force)

On Sunday the United Nations passed a resolution accusing North Korea of armed invasion and called for a cease-fire. On Tuesday President Harry S. Truman announced that American arms would be used to uphold the UN resolution and defend South Korea, and he received a supportive response from the Government and the Nation. Finally, the Security Council, at a meeting inexplicably not attended by the Soviet Union, passed a resolution proposed by the United States that all members provide assistance to South Korea in repelling the armed attack. What could have been a war between the United States and North Korea became instead a UN action.

But this did not reverse the course of the battle. The news was bad. The South Korean forces were being pushed steadily back and the U.S. presence escalated rapidly. General Douglas MacArthur was first authorized by Washington to use U.S. air power in support of the South Korean forces, and U.S. ships to supply them. And on June 30, just six days after the North Korean attack, MacArthur was authorized to commit U.S. ground forces.

It was a close call. The North Koreans overran South Korea until finally stopped at a defensive perimeter around the port of Pusan on the south coast. Then followed the well-known, tactically brilliant, U.S. landing at Inchon, completely outflanking the North Korean forces and allowing a break-out from the Pusan perimeter. After a costly but successful fight for the city of Seoul, the North Korean army was chased back to the 38th parallel that divided North and South Korea.

Now perhaps the most fateful decision of the war was taken. Despite a peace feeler started by India—strongly supported by State Department analysts George Kennan and Paul Nitze—that the original status quo in Korea be restored conditional on China being admitted to the UN, and veiled warnings from China that it would enter the war if the allied forces crossed the 38th parallel, Washington accepted MacArthur's assurance that the possibility of China entering the war was minuscule and ordered pursuit of the North Korean forces into their home country.<sup>3</sup> On November 24, 1950, with his forces near the Yalu River border with China, and promising that the war would be over by Christmas, MacArthur ordered a final offensive designed to crush all remaining resistance.

It did nothing of the kind. Instead, contrary to MacArthur's assurances, the Chinese attacked in force across the Yalu, and in an agonizing retreat the UN forces were forced south and across the 38th parallel where a stalemate developed in the positions the two armies had occupied before the start of hostilities a year before. On July 8, 1951, negotiations for a cease-fire began and lasted for two years. The war was hardly a placid beginning to what was to become known as a dull, placid decade.

The decade did not begin placidly on the domestic front either. On February 9, 1950, a little-known Republican senator from Wisconsin made a speech alleging that some large number of Communists infested the State Department. In succeeding days he polished his speech, and the number of alleged Communists settled down to fifty-seven. He wired President Truman to do something about the situation in the State Department and the press began to pay attention. Joseph McCarthy was becoming a national figure.

The Senate also paid attention. The McCarthy allegations needed investigating, and a subcommittee of the Foreign Relations Committee, under respected conservative Democratic Senator Millard Tydings, was formed to look into the allegations. The committee found no basis for McCarthy's charges, but McCarthy was not cowed. He counterattacked. He named a certain Owen Lattimore as "the top Russian agent" in the United States and alleged that he had been one of the top State Department advisors on Far Eastern policy. Nothing came of the charge, but the country began to listen. McCarthy had struck a responsive chord, and with this came an increase in power. Some powerful conservative Republican senators backed him, and Herbert Block, acid-penned cartoonist of the *Washington Post*, coined the word "McCarthyism." An era of U.S. history had been given a name.

As his support increased, McCarthy's accusations became ever broader and wilder, going so far as to charge in June 1951 that General George C. Marshall was part of "a

---

<sup>3</sup> William L. O'Neill, *American High: The Years of Confidence, 1945-1960* (New York: The Free Press, 1986): 120.

conspiracy so immense, an infamy so black, as to dwarf any in the history of man." And with the increase in recklessness came ever wider acceptance. A furor gripped the Nation. The frustration in 1949 of the concession of China to the Communists, the Soviet atom bomb, and the Alger Hiss case, expressed itself in a sweeping tide of anti-communism. Liberties that had been taken for granted were in danger of being lost. Loyalty investigations in the Government increased in intensity. The names of innocent men were being tainted and the services of "invaluable specialists" were being lost to the Government.<sup>4</sup>

After the 1952 elections, McCarthy became even stronger. He was given chairmanship of the powerful Committee on Government Operations, as well as of the permanent Subcommittee on Investigations. The Eisenhower administration did little or nothing to counteract him, for the president believed strongly in the separation of powers, and McCarthy's rampage continued. Two of McCarthy's staff members, Roy Cohn and G. David Schine, went on a quick tour of State Department installations in Europe and ostensibly found an "appalling infiltration," whereupon the department banned from its information activities all "books, music, paintings, and the like . . . of any Communists, fellow travelers, *et cetera*." Books were removed from library shelves. Some were stored; some were burned.<sup>5</sup>

At long last, things began to change. When President Dwight Eisenhower, at an extemporaneous speech at commencement exercises at Dartmouth University, decried the book ban, a loud cheer went up from the population. Many citizens by now were getting fed up with McCarthyism.

In early 1954 when McCarthy began an investigation of the U.S. Army, his end was near although he did not know it. His investigation led to an army dentist alleged to be a Communist sympathizer. The army counterattacked with the accusation that McCarthy, Cohn, and Francis Carr, the subcommittee staff director, had all conspired to obtain favorable treatment for Schine, who had been inducted into the army. McCarthy countered with his own charges that the army had tried to halt the exposure of alleged Communists at Fort Monmouth, New Jersey. The Subcommittee on Investigations ordered an investigation, but this time McCarthy was not in charge; his charges were being investigated. Even more important, he met his match in the chief army counsel, Boston lawyer Joseph Welch.

For thirty-six days the televised hearings went on with the Nation in rapt attention. The deft and skillful Welch showed McCarthy for what he was: an overbearing bully. At the climax of a highly emotional exchange, in which McCarthy attacked as a Communist sympathizer a young associate of Welch who was not even involved in the hearings, Welch asked of McCarthy, "Let us not assassinate this lad further, Senator. You have done enough. Have you no sense of decency, Sir, at long last? Have you left no sense of decency?"<sup>6</sup> McCarthy, finally silenced, did not really understand what had happened. After a few seconds the hearing room—including the members of the press

<sup>4</sup> Eric F. Goldman, *The Crucial Decade—and After: America, 1945-1960* (New York: Vintage Books, 1960): 213-214.

<sup>5</sup> *Ibid.*, 252.

<sup>6</sup> *Ibid.*, 278.



Senator Joseph McCarthy (right) blocked an attempt by Army Counsel Joseph Welch (left) to obtain names of his office staff during hearings by a special investigative committee of the Senate in 1954. The Army-McCarthy hearings, chaired by Senator Karl Mundt of South Dakota, began on April 22 and lasted through June 17. (Harris & Ewing photo, courtesy of D.C. Public Library)

—burst into loud applause. McCarthy was finished as a political force. That the Senate went on to censure him was almost redundant; the public had had enough.

Even before the demise of McCarthy as a power in the Senate, international communism had turned a somewhat more benign visage toward the world. On March 3, 1953, less than two months after the Eisenhower administration took office, Joseph Stalin died and things changed. Georgi M. Malenkov, speaking for the triumvirate of himself, Vyacheslav M. Molotov, and Nikita S. Khrushchev, offered that international conflicts could be “settled peacefully by mutual agreements of the interested parties.” In a few short months, in July 1953, the Korean War ended. Despite some early truculence by Secretary of State John Foster Dulles, the use of Soviet armor to put down uprisings in East Germany, and Khrushchev replacing the triumvirate, tensions between East and West did ease. On July 18, 1955, Eisenhower joined with Khrushchev and the leaders of Great Britain and France for a Big Four conference in Geneva. Eisenhower, whose policy toward communism had changed from “containment” to “coexistence,” proposed, as a start toward disarmament, a mutual exchange of blueprints of military establishments and mutual aerial photography—the “open skies” proposal. The proposal was not to be implemented until much later in the days of reconnaissance satellites, but a new “spirit of Geneva” had entered U.S.-Soviet relationships. It would, in later years, be called “detente.”

For a generation that had been raised during the depression years of the thirties, it is perhaps not surprising that even at the height of the Cold War and McCarthyism, the view of the American public had been turned inward, concerned with family, home, jobs, and material possessions. Now, with East-West tensions seeming to relax, with H-bombs that dramatically displayed their power in 1954 appearing to be guarantors of peace rather than instruments of global destruction, and with the president's middle-of-the-road policies, a feeling of equilibrium, of stability, had been achieved. Since the end of the war the Nation had met foreign and domestic issues and had solved them—or at least had learned to live with them.

And for those who lived them, these were times of boundless optimism. Economically the gross national product rose from \$284.8 billion in 1950 to \$483.7 billion in 1959, and more importantly, over the same period weekly spendable personal income in the manufacturing industries rose from \$57.21 to \$80.36—a rise of 41 percent.<sup>7</sup> How to spend this extra income? Why on suburban houses, tail-finned cars, TV sets, and babies—all the things that this depression-war generation had lacked. If it was a time to be decried by intellectuals for its shallowness, if the tail-finned cars were “hunks of Detroit iron,” it was also a time when more and more people could aspire to a more abundant life.

An African American could also aspire to a more abundant life, but would have trouble achieving it. Although African Americans—still called “Negroes” in the fifties—had made some progress during the Truman New Deal period, and military units had been successfully integrated during the Korean War, racism remained, in the words of O’Neill, “the greatest moral issue facing America in the 1950s.”<sup>8</sup>

There were slow changes. In September 1950, Linda Brown, the daughter of Oliver Brown, was refused admission to their neighborhood school in Topeka, Kansas. She was refused admission because, under Kansas law, African Americans could attend only segregated schools. This meant a half-hour, cross-town bus ride, and with help from the NAACP, Mr. Brown brought suit against the Board of Education. The case worked its way up to the Supreme Court, and on May 17, 1954, in what would always be known subsequently as *Brown vs. Board of Education*, the Court unanimously ruled that “separate educational facilities are inherently unequal.” A year later it “instructed Federal district courts to require the compliance of local school systems [with *Brown vs. Board of Education*] with ‘all deliberate speed.’”<sup>9</sup> The civil rights era had begun, and was to continue a year later in Montgomery, Alabama, with boycotts against segregated seating on buses. The boycotts were under the leadership of a black preacher who counseled non-violent protest. Martin Luther King, Jr., had become the leader of the civil rights revolution.

Now that life was becoming more abundant, Americans slowly began to become concerned with its quality, and the word “ecology” began to be used more frequently. Not that the Nation had not been previously concerned with nature. There were, after

---

<sup>7</sup> John Patrick Diggins, *The Proud Decades: America in War and Peace, 1941-1960* (New York: W. W. Norton, 1988): 180.

<sup>8</sup> O’Neill, *American High*: 253.

<sup>9</sup> *Ibid.*, 248-249.

all, splendid national parks as a heritage from its past, and more had been added in the immediate postwar years. But now the scale of the problem that affluence posed began to be brought home by the automobile. Many cities, most notably Los Angeles, began to experience noxious brown clouds caused by automobile exhaust fumes and power plant and industrial emissions. Quickly labelled "smog" as a combination of smoke and fog, the clouds stung the eyes and caused breathing problems. But when the wind blew, the clouds dissipated, and the Nation was slow to recognize the magnitude of the problem. Unlike London, which in 1955 passed a clean air act banning the burning of untreated coal due to its air pollution problems, the United States in the same year passed a law protecting only "the primary responsibilities and rights of the States and local governments in controlling air pollution."<sup>10</sup> The law did, however, authorize \$5 million to be used, in cooperation with State air pollution control agencies, for research and surveys of the problems. The Nation had begun to be concerned legally with air pollution, but it would not be until the late 1960s that the problem would be attacked seriously.

In the mind of the average American in the late fifties, race relations, the environment, international relations and other problems could be pushed aside. Life was good and, like a Euclidean axiom accepted without proof, the United States was the greatest country in the world. No other could match it. Then, on October 4, 1957, this placidity, this near smugness, was shattered. The next morning the newscasts carried a Soviet announcement that the U.S.S.R. had launched mankind's first satellite, which they called a "sputnik." It circled the earth every 95 minutes and emitted taunting beeps. The U.S.S.R. was clearly well ahead of the United States in rocketry, and recriminations began. They became louder when, on November 3, the Soviets announced the launching of another sputnik, this one weighing more than half a ton and carrying a dog. Was it possible that the United States was not the greater superpower? In the words of Goldman:

Throughout the United States a sense of alarm, exasperation, humiliation, and confusion mounted. Sputniks I and II dramatized as nothing else could have done that the chief thing on which Americans had depended for their national security and for victory in a competitive coexistence with Communism—the supremacy of American technical know-how—had been bluntly challenged.<sup>11</sup>

The United States accepted the challenge, and the space race began in earnest.

## SCIENCE GROWS EXPLOSIVELY

While the fifties were a time of great economic expansion, the rate of growth of the economy was dwarfed by a huge—and eventually unsustainable—rate of growth of science. Listed in Appendix A are some pertinent figures.<sup>12</sup> In the years 1953-1960,

<sup>10</sup> AN ACT To provide research and technical assistance relating to air pollution control, U.S. Statutes at Large, 69 (1955): 322.

<sup>11</sup> Goldman, *Crucial Decade*: 309-310.

<sup>12</sup> The figures on the GNP are from *Historical Statistics of the United States*, 1975 ed., U.S. Department of Commerce. The figures on R&D expenditures are from the National Science Foundation. Figures are given beginning in 1953 because reliable figures are not available for earlier years.



In October 1957, Muscovites gathered around a huge globe at the Moscow Planetarium to hear lecturers describe the sputniks' course around the Earth. In the United States, the sputniks spurred a space race and eventually resulted in an increase of direct appropriations to the Bureau. (AP-Wide World Photos)

the gross national product rose, in current dollars, from \$364.4 billion to \$503.7 billion, which gives a substantial, average annual growth of 5.45 percent—substantial even if the average inflation rate of about 2 percent for the period is taken into account. Total national expenditures for R&D, however, increased from \$5.12 billion to \$13.52 billion, a total of 164 percent, implying an annual average growth of 23.42 percent. Even more impressive was the growth in Federal Government R&D expenditures. Over the same period they increased by 217 percent, or an annual growth rate of 31.1 percent, which gives a doubling time of slightly over 2.5 years. The bulk of this went, of course, for development projects for the military and the Atomic Energy Commission (AEC), but even the annual growth rate in in-house Government R&D expenditures was substantial. As we shall see, however, the Bureau's appropriated funds did not share in this increase.

This large increase in R&D expenditures caused dislocations. Throughout the whole period of the fifties the Nation suffered a shortage of scientific manpower. In 1952, the American Association for the Advancement of Science and the discipline-oriented scientific societies formed a manpower commission to act as a consultant to Federal agencies that dealt with manpower shortages.<sup>13</sup> Studies showed that industry added

<sup>13</sup> Editorial, Dael Wolfe, "Scientific Manpower Commission," *Science* 122 (23 December 1955): 1213.

5000 to 7000 new scientists to its payroll yearly, yet failed to get all the scientists it needed in 1953 and 1954. Numerous other studies documented the problem, which was exacerbated by the fact that the pool of young scientists decreased in the early fifties partly due to military service needed for the Korean War.<sup>14</sup>

In the long term, education of scientists was the only answer to the problem, and the National Science Foundation (NSF), which spent only \$7200 on education in 1952 (not surprising since the Foundation was only two years old at that time), budgeted \$14 million for this activity in 1957.<sup>15</sup> But all domestic remedies had a long time lag. The only recourse was foreign recruitment, and industry, whose R&D expenditures rose 101 percent in the 1953-1960 period, actively recruited in Europe, particularly in Great Britain because there was no language barrier. The efforts were not looked upon favorably by the European countries, which called their loss of scientific personnel a "brain drain."

This immense increase in research and development—particularly in the Federal Government—required attention at the highest levels, but in the early 1950s there was no functioning apparatus at those levels. In December 1947 the Office of Scientific Research and Development which, under Vannevar Bush, had guided the Government's scientific activities during the war, was disbanded. On the same day, President Truman formed the Interdepartmental Committee on Scientific Research and Development. Composed of high-level science executives from all Government departments carrying out scientific research, it was hardly a replacement for the OSRD. Bush had had direct access to the president, while the new committee reported up through the departments. The NSF had been formed in 1950 and, with a very limited budget, was just getting organized. Moreover, it was primarily concerned with basic research and was not located in the Executive Office of the President. Research was being carried out throughout the Government, but without a disinterested advisory mechanism at the highest levels. What mechanism there was consisted mainly of the military and the Atomic Energy Commission, each obviously concerned with its own problems. This situation could not continue for long. The war had demonstrated to the Nation—and to presidents—the value of scientific research, particularly in military matters. Objective advisory assistance and help in policy matters at the presidential level was needed.

In the fall of 1950, under pressure of the Korean War, President Truman commissioned William T. Golden to "review the ways scientific research could be organized at the highest levels in support of military activity."<sup>16</sup> In his report Golden recommended the appointment of a science advisor to the president, and identified Mervin J. Kelly, who was later to head two committees that investigated the Bureau, as the best candidate. But the Bell Telephone Laboratories did not want to lose Kelly, and offered Kelly's superior, Oliver Buckley. Possibly because Buckley was beginning to suffer

<sup>14</sup> "Science and News: Scientific Manpower Commission," *Science* 121 (27 May 1955): 759.

<sup>15</sup> Dael Wolfe, "National Science Foundation, The First Six Years," *Science* 126 (23 August 1957): 336.

<sup>16</sup> James Everett Katz, *Presidential Politics and Science Policy* (New York: Praeger, 1978): 26.



from Parkinson's disease, and partly due to opposition of General Lucius D. Clay, then head of the Office of Defense Mobilization (ODM), the advisory apparatus became a committee reporting through ODM. The post of science advisor to the president was effectively cancelled, replaced instead with a science advisory committee.

In the early Eisenhower years the committee was not without effect. Individual members of the committee, particularly I. I. Rabi, whom Eisenhower had met while president of Columbia University, Lee A. DuBridge, president of the California Institute of Technology, and James R. Killian, Jr., president of the Massachusetts Institute of Technology, served President Eisenhower directly. These men produced or caused to be produced important reports, one of which was influential in developing the U-2 reconnaissance aircraft and the Polaris submarine, and the Gaither Report on "the potential consequences of a Soviet preemptive nuclear first strike, and . . . recommendations . . . for the protection of U.S. retaliatory forces."<sup>17</sup>

These reports fulfilled the intended special purposes, but were produced outside the science advisory committee using only the influence of the highly placed committee members. After the launching of the sputniks, Eisenhower acted to make the structure more formal. Following a meeting with the committee at which Rabi, then its chairman, recommended the appointment of a president's science advisor, the president, on November 7, 1957, announced his plans in a nationwide address. James R. Killian, Jr. would become the first special assistant to the president for science and technology. The science advisory committee was upgraded to the President's Science Advisory Committee (PSAC), with the special assistant as its chairman. A science advisory apparatus in the Executive Office of the President was in place. Then, in 1959 by Executive Order, the president formed the Federal Council for Science and Technology, an organization similar to Truman's Interdepartmental Committee for Scientific Research and Development. This completed the advisory apparatus in the Executive Office of the President. It was to last until President Nixon abolished it in 1973.

Accompanying this enormous growth in scientific research and development was an outpouring of scientific and technological advances from the Nation's and the world's university, government, and industrial laboratories. New scientific advances came at a quickening pace, followed by a myriad of new products.

The transistor, invented in 1948 at the Bell Telephone Laboratories, began the electronic revolution with its first commercial use in trunk dialing apparatus in 1951. Sony, a new name that was soon to become a household word, started Japan on its road to worldwide leadership in consumer electronics by producing the first pocket-sized transistor radio in 1952, following it seven years later with the first transistorized TV set. Computers also began their explosive growth with UNIVAC from Remington Rand in 1951, and IBM with its first scientific computer, the 701, in 1952, and the 7090, a fully transistorized model, in 1959. But one of the greatest spurs to the use of computers was the development in 1956 of FORTRAN, the first of the high-level languages that were to remove some of the tedium from computer programming.

---

<sup>17</sup> John Walsh, "The Eisenhower Era: Transition Years for Science," *Science* 164 (4 April 1969): 51.

Progress was not limited to solid-state electronics. Indeed, in a stupendous advance for all humanity, Jonas Salk produced a vaccine for polio, holding the promise of removing that scourge from the face of the earth. And in aeronautical engineering, the Comet jet aircraft began passenger service in 1952. That it was to be beset by fatigue failure problems and lose its leadership to the Boeing 707 did not prevent the jet airplane from beginning to supplant the passenger train—at least in the United States.

Nor was every new development for mankind's benefit. In 1952 the first thermonuclear device was exploded in the Pacific, followed two years later by deliverable hydrogen bombs. The process added a new and frightening phrase—radioactive fallout—to the language. When the U.S.S.R. exploded its own hydrogen bomb, an even more ominous phrase—Mutually Assured Destruction—was added.

Not only were advances made in the application of science; they were made in fundamental science itself. Physics, chemistry, mathematics, astronomy, and molecular biochemistry all saw new and basic discoveries. In physics, the long-held concept of parity invariance—namely that atomic and nuclear phenomena should not change upon mirror reflection of the world—was predicted theoretically not to hold in weak interactions by Tsing Dao Lee and Chen Ning Yang in 1957, and the prediction was confirmed experimentally at the Bureau by Chien Shiung Wu, Ernest Ambler, Raymond W. Hayward, Dale D. Hoppes, and Ralph P. Hudson. Also in physics, in 1955 James P. Gordon, Herbert J. Zeiger, and Charles H. Townes of Columbia University published a paper entitled, "The Maser—New Type of Microwave Amplifier, Frequency Standard, and Spectrometer."<sup>18</sup> This was a paper of surpassing importance for precision measurements, for it planted the seed for the laser.

In chemistry, Giulio Natta, of the Milan Polytechnic, developing ideas of Karl Ziegler, found ways of producing versions of the common vinyl polymers like polystyrene and polymethylmethacrylate that are geometrically regular on the molecular scale and hence can crystallize, unlike their more common siblings, which are polymeric glasses. A new and commercially important class of strong, tough materials had been discovered.

Also in chemistry, Willard Libby, using the idea that the atmosphere contains a constant and known concentration of radioactive C<sup>14</sup>, and therefore so do plants, devised an ingenious and important means for determining the age of artifacts such as textiles or wooden articles. Once the living plant dies, the concentration of C<sup>14</sup> begins to decrease by natural radioactive decay, and thus the measurement of its concentration, along with the known half-life of C<sup>14</sup>, provides a convenient and accurate means of calculating the age of the artifact.

Other notable advances helped change science and life in general. The first photocopying machine came on the market in 1950, and in the same year commercial color television began. Particle accelerators achieved higher and higher energies and helped in the discovery of the anti-proton and anti-neutron. In 1955 Severo Ochoa found a way of essentially synthesizing RNA, and a year later Arthur Kornberg

---

<sup>18</sup>J. P. Gordon, H. J. Zeiger, and C. H. Townes, "The Maser—New Type of Microwave Amplifier, Frequency Standard, and Spectrometer," *Physical Review* 99 (1955): 1264-1274.



Arthur Godfrey told the merits of a sponsor's product during the inaugural color television program by Columbia Broadcasting System in 1951. (AP-Wide World Photos)

did the same with DNA. John Bardeen, Leon N. Cooper, and John R. Schrieffer produced a definitive theory of superconductivity, and a peculiar celestial star-like body of enormous energy was discovered and named "quasar" for "quasi-stellar object." It was neither a placid nor a static decade for science.

### **DIVESTITURE AND REAFFIRMATION**

As the decade of the fifties began, the Bureau, beginning to be embroiled in the AD-X2 ordeal, also began its own period of explosive, but short-lived and peculiar, growth. The Korean War was to bring to the Bureau an immense increase in funds and in size, but for military work, not the measurement standards work which was its unique reason for existence. In the early years of the decade it lost a director to the Nation's obsession with Communists, and almost lost another due to the AD-X2 affair. Most important, it almost lost its identity. It had to divest itself of the war work acquired during World War II and the Korean War—important as that work was—and re-discover itself and its principal function. Almost providentially, it began the decade by restating its reasons for existence.

## A NEW ORGANIC ACT

On October 31, 1945, Gano Dunn, president of the J. G. White Engineering Company and chairman of the Bureau's Visiting Committee, was chagrined. The committee had been asked by Secretary of Commerce Henry A. Wallace to submit nominations for director of the Bureau to replace Lyman J. Briggs, who had submitted his resignation on July 22, 1945, but the committee had been dilatory in its response. Wallace proceeded on his own and selected Edward Uhler Condon as his choice to replace Briggs. Condon was in due course confirmed on November 2.<sup>19</sup> Now Dunn wrote to the other members of the committee and explained that he had met with Wallace who had cordially accepted Dunn's explanation of the delay.<sup>20</sup>

The committee was also asked to comment on another matter. The secretary had asked Briggs to prepare a revision of the Bureau's 1901 Organic Act according to Wallace's instructions, and Briggs had personally done so. Wallace was now in the process of recommending new legislation to the Senate and House. Dunn wrote to the committee, "the principal part of the amendment is for the purpose of transferring to the Organic Act certain authorizations, definitions of scope and activities of the Bureau that in the past have been covered by supplementary legislation, executive orders and customary procedure." He now asked the committee to comment on the proposed legislation.

While a revision of the Organic Act had not previously been proposed, the role of the Bureau in the post-World War II years had been discussed since the early years of the war.<sup>21</sup> In particular, the enlargement of the Bureau's mission to include basic research came under active contemplation. Now, Wallace's proposed amendment specifically took up this issue. In his draft letter of transmittal of the proposed legislation to the president of the Senate, Wallace wrote:<sup>22</sup>

Section 2(a) of the Organic Act of the National Bureau of Standards has been extended to include 'the prosecution of basic research in physics, chemistry and engineering to promote the development of science, industry and commerce.' . . .

In addition to this important phrase, two other substantive ones were mentioned by the secretary:

Section 2(a) also carries the phrase, 'the collection and dissemination of information on electrical conditions in the atmosphere affecting radio communication.' . . .

<sup>19</sup> The circumstances surrounding Wallace's selection of Condon are well detailed in MFP, 435.

<sup>20</sup> Letter, Gano Dunn to the Visiting Committee, October 31, 1945. (NARA; RG 167; Records of the Director, 1923-63, Director's Correspondence file; Box 15; Folder Dunn/APV). The other members of the committee were Vannevar Bush, Karl T. Compton, William D. Coolidge, and Frank B. Jewett.

<sup>21</sup> MFP, 432-434.

<sup>22</sup> Draft letter, Henry A. Wallace to the President of the Senate (attached to the letter from Gano Dunn to the Visiting Committee, October 31, 1945). (NARA; RG 167; Records of the Director, 1923-63, Director's Correspondence file; Box 15; Folder Dunn/APV). It is not known whether these three items were at Wallace's instigation, or whether Briggs introduced them. Considering their specificity it is highly likely that the latter was the case.

and

In Section 2(b), a clause has been added authorizing the Secretary of Commerce, with the approval of the Civil Service Commission, to appoint outstanding scientists without reference to the provisions of the Classification Act. . . .

The second item was a recognition of the fact that the Interservice Radio Propagation Laboratory, formed during the war to provide radio weather forecasts for the armed services, had in fact become a continuing responsibility of the Bureau, and was useful to the civilian sector as well as the military. The third item was justified as follows:

Men of the type we have in mind are now able to command salaries in universities higher than is authorized by the Classification Act. The appointment of a very limited number of such men from time to time would be of great value to the Bureau in conducting its work, and it is believed that the authority to do so is adequately safe-guarded by providing for the approval of the Civil Service Commission.

Besides these, a number of relatively minor items related to such things as the title of equipment bought with transferred funds and the disposition of surplus equipment, and a long listing of specific research activities the Bureau was already conducting.

Of all these items, the one relating to basic research was the most critical. Its adoption would doubtless have changed the character of the Bureau dramatically. The Bureau would have gone from the Nation's measurement standards laboratory, with all its basic research deriving from that function, to a laboratory carrying out basic research to "promote the development of science, industry and commerce," whether the research was concerned with measurement or not.

This did not sit well with Vannevar Bush, the most influential member of the committee, who at this time had recently published his report, *Science, the Endless Frontier*, and had quite different ideas of how the Government should support basic research in the Nation. On November 21, 1945, he wrote to Dunn, who two days later transmitted his comments to Wallace:

[T]he Bureau of Standards is the only body which has both the responsibility and authority to perform the exceedingly important function of establishing standards of all kinds, and in the future the Bureau is going to be subjected to a heavy and increasing burden in this regard as a result of the rapid progress of science. . . .

Hence, while I believe that it [the legislation] is important to the effective organization of the Bureau and to its ability to conduct basic research . . . it should be unmistakably clear that the major emphasis should remain on its unique assignment in the field of standards.<sup>23</sup>

---

<sup>23</sup> MFP, 433-434; letter, Vannevar Bush to Gano Dunn, November 21, 1945 (attached to letter, Dunn, November 23).

The revision was not passed in its original form. Indeed, it was not passed until July 22, 1950, by which time its instigators, Wallace and Briggs had long since left the Federal Government. It was submitted to the House Committee on Interstate and Foreign Commerce by the then Secretary of Commerce Charles W. Sawyer on June 17, 1949, with the justification:

This legislation is considered necessary in order that basic authority for the functions of the Bureau will include a more specific outline of the scientific research and testing now carried on by the Bureau. This is particularly desirable in view of the advances which have been made in certain fields of science.<sup>24</sup>

Except for one important change, the new law was a much more moderate revision than originally proposed. The major change occurs at the very beginning. Whereas the original act, and that written by Briggs and proposed by Sawyer, simply state, "The functions of the Bureau shall consist . . .," the new law states, "The Secretary of Commerce . . . is authorized to undertake the following functions. . . ." Authority for the functions of the Bureau is now vested in the secretary, rather than in the Bureau director. Similarly, all other specific references in the law to functions of the Bureau are changed to functions of the secretary. The law specifies, however, that the director is appointed by the president.

This change was made by the House committee, but it was not done as a result of any prejudice toward the Bureau. Rather, it was "to make this bill conform to the provisions of Reorganization Plan No. 5 of 1950, which transferred to the Secretary of Commerce all functions of all other officers of the Department of Commerce and all functions of all agencies and employees of such Department."<sup>25</sup>

The functions that the secretary is authorized to carry out are spelled out in six paragraphs, rather than in a single one as in the old law. However, with the one exception discussed below, the first two paragraphs essentially re-state the first of the original act. The added four are merely statements of what the Bureau was already doing. Following this statement of authorized functions, there follows a listing of nineteen activities which, along with "similar ones," the secretary is allowed to undertake. Some were obvious, others less so.

None of the three new functions listed by Wallace in the covering letter to his original proposed revision is specifically mentioned. In fact, with respect to avoiding the Classification Act of 1949, and referring to Sec. 4 of the original act—in which salaries were specified—the law reads, "Sec. 4 (Salaries of officers and employees. This section superseded by Classification Act.)" Briggs' hope of getting special treatment for scientific personnel was effectively dashed. The "radio weather" function is not mentioned, doubtless because it was clear that the Bureau was able to carry out this function without specific authorization. In fact, this function was a line item in the Bureau's budget between 1950 and 1956, when the Bureau's budget request was

<sup>24</sup> House Committee on Interstate and Foreign Commerce, *Bureau of Standards Functions*, 81st Cong., 2d sess., 1950, H. Rept. 2349: 3.

<sup>25</sup> *Ibid.*, 2.

changed. And, with respect to the most important new function in the proposed amendment by Wallace and Briggs, that of carrying out "basic research . . . to promote science, industry and commerce," it was simply not included. It is well to remember that the National Science Foundation was established in 1950 with the specific aim of funding basic research throughout the Nation. Authorizing this function for the Bureau would have meant that two agencies of the Government would share the same function, a clearly undesirable situation. The Bureau was not, however, excluded from carrying out basic research. Authorized activity number 18 reads, "the prosecution of such research in engineering, mathematics, and the physical sciences as may be necessary to obtain basic data pertinent to the functions specified herein." The Bureau could do basic research, but within circumscribed boundaries, which is what Vannevar Bush suggested in his letter to Dunn.

A comparison of the authorized functions in the old and new Organic Acts is instructive in illustrating how the Bureau had grown since its inception. In the 1901 law, all the functions are contained in one paragraph:

Sec. 2. That the functions of the bureau shall consist in the custody of the standards; the comparison of the standards used in scientific investigations, engineering, manufacturing, commerce, and educational institutions with the standards adopted or recognized by the government; the construction, when necessary, of standards, their multiples and subdivisions; the testing and calibration of standard measuring apparatus; the solution of problems which arise in connection with standards; the determination of physical constants and the properties of materials, when such data are of great importance to scientific or manufacturing interests and are not to be obtained of sufficient accuracy elsewhere.

In the 1950 law, the first paragraph of the 1901 act—with one significant change—is essentially repeated in the first two paragraphs, and four others are added.

(a) The custody, maintenance, and development of the national standards of measurement, and the provision of means and methods for making measurements consistent with those standards, including the comparison of standards used in scientific investigations, engineering, manufacturing, commerce, and educational institutions with the standards adopted or recognized by the Government.

(b) The determination of physical constants and properties of materials when such data are of great importance to scientific or manufacturing interests and are not to be obtained of sufficient accuracy elsewhere.

(c) The development of methods for testing materials, mechanisms, and structures, and the testing of materials, supplies, and equipment, including items purchased for use of Government departments and independent establishments.

(d) Cooperation with other governmental agencies and with private organizations in the establishment of standard practices, incorporated in codes and specifications.

(e) Advisory service to Government agencies on scientific and technical problems.

(f) Invention and development of devices to serve special needs of the Government.

The significant change is the lack of Stratton's marvelous catchall phrase, "the solution of problems which arise in connection with standards."<sup>26</sup> Due to the tradition it had fostered, its lack would not hamper the Bureau. The new functions (c) to (f) were no more than statements of functions the Bureau had developed in its history. Item (c) was not in the original act, and was the one that led to the AD-X2 incident, although in the vast majority of cases a valuable service was performed for the Government. Item (d) covered the Bureau's interaction with the organizations of the voluntary standards system of the Nation. Item (e) referred to work for other agencies of the Government, and item (f) referred primarily to work carried out during the two world wars, which had led to such developments as the proximity fuze and computers.

With the exception of vesting in the secretary of commerce the authority to carry out all the functions of the Bureau, which was in any case necessitated by law, there was no significant change in the Bureau's Organic Act. The Bureau was not prevented from continuing to do what it had been doing. The revision seems rather to have been designed to answer those members of Congress who could not understand how the Bureau could do all the things it did on the basis of "a two-page law," and to list a number of examples of activities the Bureau carried out, and clearly felt it needed to continue to carry out. The new law did not noticeably change the Bureau's mode of operation.

On March 2, 1951, the year after the passage of the new Organic Act, the Bureau turned fifty years of age. It was a time of commemoration and of celebration. After some pondering about what kind of celebration to have, Condon decided to schedule twelve symposia on technical issues of importance to the Bureau and the Department of Defense, which helped financially with the symposia. With speakers from throughout the scientific community, the topics were low-temperature physics, influence of low temperatures on the mechanical properties of metals, gravity waves,<sup>27</sup> solution of simultaneous equations and determination of eigenvalues, mass spectrometry, energy transfer in hot gases, electrochemical constants, polymer degradation mechanisms, evaluation of optical imagery, electron physics, characteristics and application of resistance strain gages, and electrodeposition research. In addition, more than thirty technical societies and associations held meetings in Washington to commemorate the

---

<sup>26</sup> A Bureau wag likened this phrase to a "license to steal."

<sup>27</sup> These were waves, such as water waves, in which gravity was one of the causative factors, not the yet-to-be-observed waves predicted by general relativity in the cosmological gravitational field.



Bureau's semicentennial. These were happy occasions and many societies and associations provided commemorative anniversary scrolls.<sup>28</sup>

Not quite so happy for the junior staff, who had to spruce up the laboratories, was the open house held in February 1955. Suggested by Sinclair Weeks to make people more aware of the nature and importance of the Bureau's work, the open house featured presentation ceremonies by Director Astin, followed by laboratory tours and demonstrations. It was a successful event, attended by some 600 scientists from the Nation's laboratories. The open house was followed in April by a more informal Guest Week for the general public.<sup>29</sup> In more ways than one, the Bureau was emerging from its wartime cocoon.



The NBS Open House was attended by several hundred leaders in the fields of science, industry, government, and education. It stressed the significance of physical measurement standards to scientific and industrial progress. Ralph Hudson demonstrated equipment for visitors in the low temperature lab.

### LOYALTY, SECURITY, AND THE RESIGNATION OF A DIRECTOR

When Edward Uhler Condon joined the Bureau as its director on November 7, 1945, he was already a world-famous theoretical physicist and scientist-administrator, on first-name terms with all the leading figures in science. Personally, he was a

<sup>28</sup> Annual Report, 1951: 100. See also *Technical News Bulletin*, 1951 and 1952, for details of the symposia and the society meetings.

<sup>29</sup> Annual Report, 1955: 11.

gregarious, enthusiastic, friendly man who did not suffer fools gladly, was impatient with sloppy thinking, had “an ever ready and exuberant sense of humor, and a gift of repartee, but he could be wittily caustic when provoked.”<sup>30</sup> He was vigorous and aggressive with myriads of new ideas, and was not afraid to push them.

When he came to the Bureau he found a capable institution, even though the scientific ideas of many of its leaders were rooted in the past, not the modern physics which he had helped foster. Given his background and personality, it was only natural that Condon should set about to remake the Bureau and lead it—with some kicking and screaming—into modern science. How he did this, and the areas he led it into are well described in *Measures for Progress* and will not be emphasized here.<sup>31</sup> Rather, Condon’s relations with the loyalty and security apparatus of the Nation in the post-World War II years will be discussed, beginning with a short biography and emphasizing some aspects that were important in influencing those relations.

Edward Uhler Condon was born March 2, 1902, in Alamogordo, New Mexico, where forty-three years later man’s first nuclear explosion would take place. His family was mobile, and he went to various grammar schools throughout the West. He attended high school in Oakland, California, graduating at the ripe age of sixteen. During his last two years in high school, he went into newspaper reporting, first for the high school paper, and later, in the summer of 1918, for the “regular newspapers” of Oakland.

Two events which shaped his future thinking happened in Condon’s short newspaper career. First, in October 1918, he recalls:

[A] regiment of Oakland boys was put into the front-line trenches in France in the final battles of the war. . . . In the final days of the war, these boys were being killed at the rate of about five a day. My steady assignment as a 16-year-old reporter was to go out each day to interview the mothers of the boys on that day’s casualty list, and to steal photos or letters whenever possible. . . . I was often the first one to convey the news to the mother that her son was dead.

Such experiences left a deep-seated scar on me and an urgent need to do what discouragingly little I can toward bringing about peace and disarmament. . . .

The second occurred on November 9, 1919. He was

the only reporter from a conservative newspaper to cover the organization meeting of the Communist Labor Party of California, as it was called then. I wrote lurid and sensational stories about this small group of one or two hundred persons, which resulted in indictments against them, and which required that I had to testify against them, in trial after trial, over the next several years. In this connection I became aware of open boasting by a police detective of his having framed some of the defendants in a matter where I knew the facts to be otherwise.

<sup>30</sup> Churchill Eisenhart, “Dr. E. U. Condon (1902-1974), Renovator of the NBS.” *Dimensions* 58 (1974): 150-151, 166.

<sup>31</sup> MFP, 434-446.



Edward Uhler Condon, world renowned theoretical physicist, became the fourth director of the National Bureau of Standards and the first to be appointed from outside the Bureau's ranks. He reorganized the Bureau in the postwar years, brought in bright young people, and instilled in the staff a great desire to do basic research in physics, chemistry, and on methods which provide the basis for measurements.

The effect of this involvement on me was to wipe out any desire to be even an educated newspaperman; so I entered the university and went into physical science largely as a means of escape from the corruption of the world, in addition to the fact that I was genuinely interested in physical science.<sup>32</sup>

Entering the University of California at Berkeley in 1921, he flirted with chemistry and engineering before finally choosing physics as his profession. By 1926, at twenty-four, he had a wife, having married Emilie Honzik in 1922, and a Ph.D. in physics, having developed in his thesis the basis for what was to become known as the Franck-Condon principle. He then spent a year at Göttingen and Munich learning quantum mechanics from the European masters. Upon returning to the United States, he spent a year at Columbia, one at Princeton, and another at the University of Minnesota where, at the age of twenty-seven, he was a full professor of theoretical physics. In 1930 he returned to Princeton, where he remained until 1937 when he left academia and joined the Westinghouse Research Laboratory as associate director of research. He stayed there until he joined the Bureau as director in 1945.

As expected for a scientist of his caliber, he was very active in war research.<sup>33</sup> The following is a listing of his positions:

- In the fall of 1940, he was among the first dozen staff attached to the Radiation Laboratory at MIT. Under sponsorship from the National Defense Research Committee (NDRC), this laboratory had responsibility for all secret microwave and radar developments for the military agencies.

<sup>32</sup> E. U. Condon, "Reminiscences of a Life in and out of Quantum Mechanics," *Proceedings of the International Symposium on Atomic, Molecular and Solid-State Theory and Quantum Biology*, ed. Per-Olav Löwdin, *International Journal of Quantum Chemistry, Symposium no. 7*. (New York: Wiley, 1973): 9.

<sup>33</sup> This list of activities is taken from a letter from Condon to the Army-Navy Personnel Security Board, February 7, 1953. (American Physical Society; Condon File; Security, Box 3; Folder Security Investigations, 1953, No. 3. Used with the permission of the American Philosophical Society.)

- Subsequently, he was chairman of the Westinghouse Electric Corporation's committee on radar, which brought him into close association with secret radar matters at the Naval Research Laboratory. This association allowed him to receive information on highly classified radar developments from the military departments on the manufacture of radar equipment.
- In 1941 he served on an NDRC committee which considered and recommended the development at the California Institute of Technology of a large secret rocket program.
- In the summer of 1941, he was appointed a member of the highly secret S-1 Committee under Lyman J. Briggs. This was the committee established by President Franklin D. Roosevelt upon receipt of the famous Einstein letter, and led to the eventual formation of the Manhattan Project.
- During 1942 he was actively engaged in secret radar research work in the laboratories and plants of the Westinghouse Electric Corporation.
- In April and May 1943, he served for a short time as associate director of the newly established Los Alamos Scientific Laboratory. While there he wrote a manual from the notes that he took during a series of five lectures given by Robert Serber. Called *The Los Alamos Primer*, the report was so secret that, after Condon left Los Alamos, he did not see a copy of it until it was declassified.<sup>34</sup>
- In the early fall of 1943, he was assigned by Westinghouse to work at the Radiation Laboratory of the University of California at Berkeley. The work was highly secret and concerned entirely with the atomic bomb. In late 1945, upon successful completion of his phase of the work, Condon returned to Pittsburgh and resumed his radar work.

There needs to be added to this account the fact that when Condon became director of the Bureau, Senator Brien McMahon, chairman of the Special Senate Committee on Atomic Energy, was holding hearings on a bill to remove atomic energy from the military and place it under civilian control—something that was supported by President Truman but opposed by the military. When Condon arrived in Washington he was asked by the McMahon committee to serve it as a scientific advisor, whereupon he was detailed from the Bureau to do so. From late 1945 until mid-1946, Condon gave lectures to senators, explaining to them the fundamentals of atomic energy. When the law was passed on August 1, 1946, and the Atomic Energy Commission was formed, Condon returned to being director of the Bureau full time.

---

<sup>34</sup> Letter, Glenn T. Seaborg to E. U. Condon, February 26, 1963. (Copy in NIST History File). Condon wrote to Seaborg who was then Chairman of the Atomic Energy Commission and requested a copy of the now declassified *Primer* for his files. Seaborg complied with Condon's request and noted "its historical significance and the fact that it was apparently the first report issued by the Los Alamos Laboratory." The *Primer* was later annotated by Robert Serber and published in 1992 as the *The Los Alamos Primer: The First Lectures on How to Build an Atomic Bomb*, University of California Press.



Photographed while conferring on military control of atomic energy development were (left to right: Harlow Shapley of Harvard University, Representative Chet Holifield, Democrat of California, and Harold Urey and Thorfin R. Hogness of the University of Chicago. A bill that would transfer atomic control from the military to a civilian agency was under consideration in 1946. Holifield would later come to Condon's defense when his service in the capacity of scientific advisor to the Senate on this question resulted in accusations of disloyalty. (AP-Wide World Photos)

But he even had to take some time off from his advisory activities, for the president asked him to become one of a number of scientific observers at Operation Crossroads, the testing of atomic bombs at Bikini Atoll in the spring of 1946. At this operation he met and became friendly with Congressman Chet Holifield of California, an event that was to stand him in good stead in the following years.

Thus, in 1946 the Bureau had as its director a vigorous, driving man who was one of the scientific leaders of the world, had participated in some of the most important and secret work of the Nation during the war, and had undertaken many special assignments. Not a retiring man, he was an outspoken liberal and a fervent anti-isolationist. What was perhaps not as obvious, the new director was a pious man who was a Quaker by upbringing, and from his experiences was passionately against war and devoted to peace and cooperation among nations. "My wife and I," he wrote and had published in the *Congressional Record*,<sup>35</sup> "have fervently hoped that the wartime

<sup>35</sup> House, Extension of Remarks of Hon. W. Sterling Cole of New York in the House of Representatives, *Congressional Record*, March 24, 1952, 98:A1827.

cooperation which existed between Russia and the United States would develop into a peacetime friendship like that between England and the United States. For this reason we have always tried to be friendly to people from the Slavic countries whom we met in official diplomatic contacts at Washington.”

As a result of his newspaper experience he also had developed a healthy skepticism about the actions and utterances of public officials, and a dislike bordering on loathing for the cynicism of some of them.

\* \* \*

On March 1, 1948, New Jersey Congressman J. Parnell Thomas, chairman of the House Committee on Un-American Activities, lay ill in bed at Walter Reed Hospital, suffering from an attack of gastrointestinal hemorrhages. Nevertheless, he reportedly found time to meet with Congressmen Richard B. Vail and John S. Wood, the other two members of the Subcommittee on National Security, to decide whether to release a “Report to the Full Committee.” The report carried out one of the functions of the committee, and the decision was made to release it. The function promised, in ungrammatical fashion, “those groups and movements who are trying to dissipate our atomic bomb ‘know-how’ for the benefit of a foreign power will have the undivided attention of our committee agents, as well as those who are seeking to weaken other aspects of our national security.”

Described as “preliminary,” and of an investigation that was not yet complete, the report dealt with only one topic: Edward U. Condon, director of the National Bureau of Standards. In a “matter which is of such importance that it demands immediate attention,” the report stated at the very beginning, “from the evidence at hand, it appears that Dr. Condon is one of the weakest links in our atomic security. In substantiation of this statement the subcommittee respectfully submits the following information.” Six pages of text purported to provide the substantiation.<sup>36</sup>

Newspaper headlines flashed the news around the country to a dumbfounded Nation, but it was not the first time Condon had run afoul of the committee, or at least of one of its members. During 1947, five articles originating from the committee or from Representative Thomas appeared, three in the *Washington Times-Herald*, a newspaper “which has always had close and friendly relations with the Un-American Activities Committee and which has often been used by the committee to send up trial balloons.”<sup>37</sup> These articles attacked Condon and promised that he would be investigated. In June, Thomas wrote two signed articles, one in *American* magazine, and one in *Liberty*. These articles attacked Condon because of his association with the American-Soviet Science Society.

Several times Condon tried to be heard by the committee; his requests were ignored. The attacks were so blatant that Representative Holifield was impelled to bring them

---

<sup>36</sup> House Committee on Un-American Activities, Subcommittee on National Security, *Report to the Full Committee of the Special Subcommittee on National Security of the Committee on Un-American Activities*, 80th Cong., 2d sess., March 1, 1948.

<sup>37</sup> Robert K. Carr, *The House Committee on Un-American Activities* (Ithaca, NY: Cornell University Press, 1952): 132.

up on the floor of the House. On July 22, 1947, he delivered a scathing denunciation, answering the attacks point by point and showing them to be false or misleading.<sup>38</sup> He came to the conclusion that Condon was attacked because of his activities as advisor to the Senate Select Committee on Atomic Energy, and that those who did not want to see civilian control of atomic energy were behind the attacks.

But the later charges in the subcommittee's report were more serious. This was a formal attack on Condon made by a subcommittee of the United States Congress, without the accused having been given an opportunity to answer the charges. The document was filled with errors, inaccuracies, and innuendo. Eight days later, Holifield delivered a piercing evaluation of it. His analysis was complete and thorough, and his main points are summarized here.<sup>39</sup>

The subcommittee's report suffered from sloppy staff work and writing. In the first two paragraphs there are seven inaccuracies, mostly unimportant and one even amusing, but nevertheless indicative of the lack of care taken in the writing of the report. For example, the maiden name of Mrs. Condon was given as Emilie Honzek rather than Honzik; Condon's position at Princeton was given as "associate director of the physics department," a nonexistent post; Condon was associate professor. The amusing one read as follows: "Condon is principally regarded as a theoretical physicist which involves radar, nuclear physics, radioactive tracers, mass spectroscopy, and the elastic properties of metals." When giving the background of Mrs. Condon, she is gratuitously identified as "an American-born woman of Czechoslovakian descent." The reason for this remark arose at the end of the report, where the following passage occurs: "In this country they [the communists] haven't gotten as far as they have in Czechoslovakia, but they got pretty far, because they got a man [Henry Wallace] as Vice President of the United States, and he is now their candidate for President, and he is the same man who recommended Dr. Condon as Director of the Bureau of Standards." By innuendo, Mrs. Condon's ancestry served to imply that, at a minimum, the Condons were friendly toward communism.

Two questions concerning Condon's early days at the Bureau attracted the committee's attention. One was security clearance. Condon had, of course, been completely cleared for his atomic energy work at Los Alamos and Berkeley, and for all the other areas he worked in. He retained those clearances when he came to the Bureau. However, upon the formation of the Atomic Energy Commission (AEC), that agency set up its own clearance procedures and had not yet completed them on Condon at the time the matter was investigated by the subcommittee. Under the AEC's "need to know rules," he was still excluded from certain areas, such as atomic weapons. Hence his clearance was marked "pending," but this was no more than bureaucratic inertia.

---

<sup>38</sup> Representative Chet Holifield, speech, *Smearing the Scientists: Attempt To Discredit Civilian Atomic-Energy Control*, reprinted from Congressional Record, July 22, 1947, vol. 93.

<sup>39</sup> Representative Chet Holifield, speech, *Sabotage of American Science: The Full Meaning of Attacks on Dr. Condon*, reprinted from Congressional Record, March 9, 1948, vol. 94. Holifield analyzed the whole report of the Committee on Un-American Activities in this speech that contained the full text of the subcommittee's report.

With respect to the second question, that of the reorganization of the Bureau, Condon carried this out in 1947.<sup>40</sup> In the process, and as was natural considering his background and the main thrust of modern physics, he formed a division called the Atomic and Radiation Physics Division, and made himself division chief until such time as he could find someone qualified. The report implies that he did this so he could be closer to the secret atomic work at the Bureau, but as director he would, of course, have known about it anyhow.

These were minor points. Major sections of the report were concerned with two letters, and with associations. With respect to the first letter, it states the following:

That the Atomic Energy Commission had reason to doubt the loyalty of Dr. Condon is evidence by a letter, the original of which the subcommittee has in its possession, which letter was dated July 11, 1946, and is addressed to a Member of Congress, who at that time was a member of the Joint Committee on Atomic Energy of the Congress. This letter was written by a person who held a high post in the security division of the Manhattan Project, and who is now a ranking official of the Atomic Energy Commission. The first paragraph of this letter is quoted in part as follows:

Attached is a very hurried attempt which may be of some help. Unfortunately, the . . . group has loaded me down in preparation for Friday's meeting. May I suggest that you demand Dr. Condon's record of the FBI. It would be enlightening.<sup>41</sup>

This letter was demolished by Holifield. Briefly, it was a letter from an unknown person to an unknown member of Congress on a nonexistent committee, for the Joint Committee on Atomic Energy was not formed until the year following the date of the letter. While it did not say anything harmful about Condon, it implied a great deal. But it said more about the unknown author. As pointed out by Holifield, if indeed the author had been a high official in the Security Division of the Manhattan Project and was now a ranking official in the AEC, and if he knew all this time that Condon was a security risk and did nothing about it, he could be accused of dereliction of duty.

A significant portion of the report dealt with associations. These were mentioned in a confidential letter from the FBI to Secretary of Commerce Averell Harriman. A portion of this letter had come into possession of the committee, and it was quoted "in part."<sup>42</sup> A particularly important part read:

---

<sup>40</sup> MFP, 438.

<sup>41</sup> Holifield, *Sabotage of American Science*: 9.

<sup>42</sup> The subcommittee did not have the full text of the letter. Chairman J. Parnell Thomas had sent a letter to an employee of the Department of Commerce asking that one of the subcommittee's investigators be furnished "any information you have available on Edward U. Condon. . . ." The investigator was "permitted to make a brief examination of a file of papers and documents, among which was the letter. . . [He] undertook to make a copy of this letter, but before he was able to copy all of it he was requested to discontinue." (J. Parnell Thomas, *Congressional Record*, May 14, 1948, 94:5862-63. A critical part of this letter was not in the missing portion, yet was not quoted in the subcommittee's report.



The files of the Bureau [FBI] reflect that Dr. Edward U. Condon has been in contact as late as 1947 with an individual alleged by a self-confessed Soviet espionage agent to have engaged in espionage activities with the Russians in Washington, D.C., from 1941 to 1944.<sup>43</sup>

The report did not detail what the nature of the contact was, but this was clarified three days later when, on March 4, an enterprising reporter from the *Washington Post* supplied a missing sentence of the letter that, according to its chairman, the subcommittee had "inadvertently" left out. The sentence read:

There is no evidence to show that contacts between this individual and Dr. Condon were related to this individual's espionage activities.<sup>44</sup>

Holifield commented on this omission:

What does this deletion or omission mean in terms of a full and careful presentation of evidence? What is this if not deliberate character assassination, without regard to truth, justice, the democratic processes, honesty, integrity, or fair play?

The origin of the letter is not completely known. What is known is that in April 1947, after the subcommittee's attacks on Condon, Secretary Harriman was asked by Condon to investigate him. Harriman did this and "subsequently assured Dr. Condon that he was entirely satisfied."<sup>45</sup>

Other associations, some with persons from Eastern European diplomatic circles, were mentioned in the letter, which at this point mentioned Condon's wife Emilie as well. The Condons had never met some of the persons with whom they were alleged to have had associations, and the others were met in the normal course of Washington diplomatic life. There is no evidence presented to show that these associations were any more than that.

The report went on to detail that there were many foreign visitors to the Bureau, many from Eastern European countries; that Condon had appointed an assistant, Dmitri I. Vinogradoff, a Russian-born American citizen with whom he had worked at Westinghouse, to act as liaison for these visitors; and that discussions were held with Soviet representatives on the exchange of scientific publications.<sup>46</sup> Nowhere was it

<sup>43</sup> Holifield, *Sabotage of American Science*: 10.

<sup>44</sup> Alfred Friendly, "Condon Associated With Alleged Spies, Anti-Red Unit Charges." *The Washington Post*, March 3, 1948: A1.

<sup>45</sup> Holifield, *Sabotage of American Science*: 11.

<sup>46</sup> *Ibid.*, 16. The Bureau had an established policy of exchange of scientific publications with the Soviet Union and had a mailing list of about seventy Russian institutes to which Bureau publications were routinely sent. Condon was anxious to get as much Russian scientific information as possible, but after the war the flow of such information from the Soviets had slowed down. Condon asked Vinogradoff to look into the matter. The Soviet Embassy explained that the slowdown was because of the destruction caused by the war; however, rumor persisted that the Soviets had adopted a policy of not sending material. Vinogradoff consulted with the State Department and, in cooperation with State, Condon wrote to the Russian institutes that "in view of the uncertainties the Bureau could no longer send our material to them." Rather than Condon increasing the flow of material to the Soviet Union, he decreased it.

stated that there was any discussion other than of published material freely available in the scientific press was discussed. Yet the implication was left that something shady was taking place.

Finally the report brings up the American-Soviet Science Society (ASSS). This small society, numbering about 400 members, was formed to stimulate scientific cooperation between the Soviet and American scientists. It had originally been formed as the science committee of an organization called the National Council of American-Soviet Friendship (NCASF). The latter group was formed in late 1943 when the United States and the Soviet Union were allies, and was sponsored by many distinguished Americans, among them Karl T. Compton, Albert Einstein, and Senators Elbert Thomas of Utah, Arthur Capper of Kansas, and Leverett Saltonstall of Massachusetts.<sup>47</sup> At one time Mrs. Condon was the corresponding secretary of what was essentially the Pittsburgh branch of that group. However, the ASSS disassociated itself from the NCASF, and in 1946 was a separate organization,<sup>48</sup> while in 1947, the NCASF was on the Attorney General's list of subversive organizations. The ASSS, on the other hand, was a tax-exempt organization with a grant of \$25 000 from the Rockefeller Foundation. It had also done some consultation for the Army and Navy, and carried out translation of scientific work, which was its principal objective.<sup>49</sup>

Condon was accused of proselytizing the staff of the Bureau for membership because he lent his name to a letter from Samuel Gelfin of the membership committee of the ASSS to the Bureau staff asking them to consider joining. To Condon this was a perfectly routine matter, and he put no pressure on anyone to join.

The report closed with the unequivocal recommendation:

It is the unanimous opinion of this subcommittee that Dr. Condon should either be removed or a statement should be forthcoming from the Secretary of Commerce, setting forth the reasons why he has retained Dr. Condon, in view of the derogatory information which he has had before him.

Holifield remarked, "With regard to the conclusions and recommendations, it is my opinion that no evidence has been adduced in this report or any other which merits a breath of support to the conclusion that he [Condon] should be removed."

In a manner similar to the events that would take place after Allen V. Astin's dismissal as Bureau director during the battery additive episode, the report caused a national sensation. Condon was front-page news in the Nation's leading newspapers for more than a week, with the bulk of the reaction against the report and the subcommittee. The scientific community rose up in arms in support of Condon, who was then president of the American Physical Society. He received so many letters of support that he wrote a form letter to answer them.<sup>50</sup> A testimonial dinner, attended by

<sup>47</sup> *Ibid.*, 17.

<sup>48</sup> House Committee on Un-American Activities, *Testimony of Dr. Edward U. Condon: Hearing Before the Committee on Un-American Activities*, 82nd Cong., 2d Sess., September 5, 1952: 3883. Hereafter this hearing will be referenced as "Condon Hearing."

<sup>49</sup> Holifield, *Sabotage of American Science*: 17.

<sup>50</sup> American Philosophical Society; Condon file; Security box 2; Folder Security Investigations, 1948, Public Reaction to Rep. J. P. Thomas' Attack #1.

150 leading American scientists, including eight Nobel Laureates, was held in New York on April 12.<sup>51</sup> Cartoonists had a field day. Condon did not remain silent. He issued a statement which included the sentence, "If it is true I am one of the weakest links in atomic security that is very gratifying and the country can feel absolutely safe for I am completely loyal, conscientious and devoted to the interests of my country, as my whole career and life clearly reveal."<sup>52</sup> He also renewed his request for a public hearing.

The continual conflict kept the story on the front page.<sup>53</sup> Thus, within a few hours of the release of the subcommittee's report, the Department of Commerce issued a statement that Condon had been given a loyalty clearance six days before. "No reasonable grounds exist for believing that Dr. Condon is disloyal to the Government of the United States," the statement declared.<sup>54</sup> The next day, Rep. Thomas issued a subpoena for the Hoover letter to Harriman and other parts of the FBI file on Condon. The

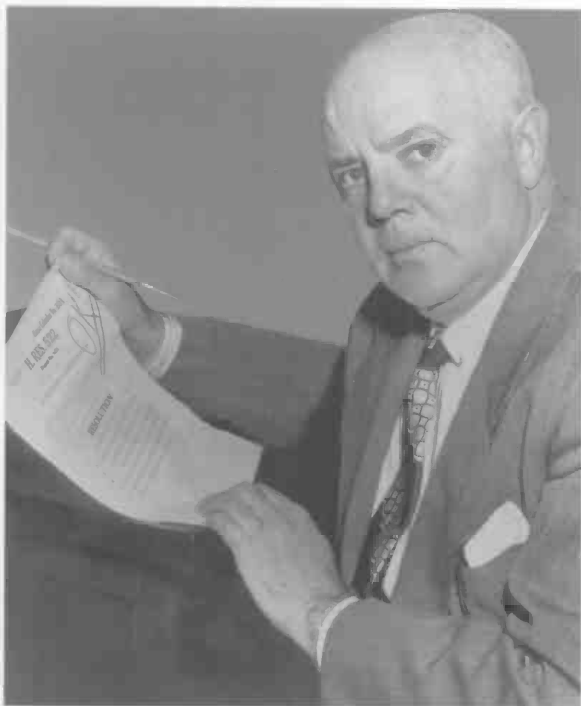

J. Parnell Thomas, chairman of the House Committee on Un-American Activities, posed for an Associated Press photographer with a copy of a resolution passed by the House on April 22, 1948. The resolution directed Secretary of Commerce Harriman to turn over a letter from the FBI that detailed Condon's association with an alleged spy. (AP-Wide World Photos)

<sup>51</sup> American Philosophical Society; Condon file; Teller box; Folder Testimonial dinner, April 1948.

<sup>52</sup> *New York Times*, March 2, 1948.

<sup>53</sup> A good chronology of newspaper stories between March 1 and October 1, 1948, is given by Joseph T. Klapper and Charles Y. Glock in "Trial by Newspaper," *Scientific American* 180(2) (1949): 16-21. The list, which is not exhaustive, contains 32 entries.

<sup>54</sup> Carr, *The House Committee*: 149.

following day Harriman refused. The same day, the *Washington Post* reported on the missing sentence. Late in March, the House had announced that it would hold a public hearing on April 21. On April 14, the hearing was postponed. It was not to be held until 1952, by which time the cast of characters had changed. Finally, on July 15, 1948, the AEC reached its conclusions on the Condon case:

On the basis of the voluminous record before it, the members of the Commission are fully satisfied that, in the terms of the statute [Atomic Energy Act], Dr. Condon's continued clearance for the purposes stated above "will not adversely affect the common defense and security" of the United States. The Commission considers that his continued clearance is in the best interests of the atomic energy program.<sup>55</sup>

By 1949 the story had run its course and things had quieted down somewhat, but Condon still had the cloud of the report hanging over him. And like sporadic sniper fire, occasional shots would be fired by either side, but it was not until June 10, 1949, that a major outbreak occurred again from an unexpected quarter. The espionage trial of Judith Coplon was being held, and it was alleged that a number of notes referencing FBI files were found in her handbag. These files were made public at the trial. One of them alleged that Mrs. Condon was contacted by a certain Morton E. Kent, who was interested in selling inexpensive printing machines in Europe. Mrs. Condon allegedly gave him the name of a Bulgarian accused by the FBI as an espionage agent, implying that she knew him quite well. What made the whole incident news was that on June 11 Kent had committed suicide. The Condons' version of the story was that Mrs. Condon attended a church meeting called to raise funds for aid to devastated European schools. Dimitrov Sotirov, the Bulgarian in the files, spoke at the meeting. He was an employee of the United Nations, and this was the only time Mrs. Condon met him. All that happened was that Mrs. Condon told Kent, whom she met at a social gathering, how to reach Sotirov by telephone.<sup>56</sup> Because the material in the FBI files was, as usual with raw FBI files, "unevaluated" yet nevertheless released, Condon called for a public apology from FBI Director Hoover, and also wrote a personal letter to him. Hoover did not apologize, but he did write Condon a personal letter saying he had sent Condon's letter to the attorney general since the situation that prompted the letter was a judicial proceeding.

Whatever the case, the Condons were again in the newspaper linked to Eastern European nationals and alleged espionage agents. There seemed no way to get a hearing to clear their names.<sup>57</sup> And the matter was not kept closed. In early 1951,

---

<sup>55</sup> Letter and memorandum of decision approved by the Atomic Energy Commission, David E. Lilienthal to Charles Sawyer, 15 July 1948. (NARA; RG 40; General Correspondence file; Box 1080; Folder 104462-104482 (104475))

<sup>56</sup> Draft statement by Mrs. Emilie Condon. (American Philosophical Society; Condon file; Security box 2; Folder Security Investigations, 1949, #2)

<sup>57</sup> Condon Hearing, 3871-3872. Actually, in June 1949, the House Committee on Un-American Activities, now reconstituted after the 1948 elections, invited Condon through the medium of a press release to appear if he would like to. Condon wrote a letter to the committee, apparently accepting the invitation, but never mailed it. When asked about this when the hearings were finally held, Condon stated, "It has been my policy all along not to come except under subpoena." He felt that invitations via the newspapers were too informal.



President Dwight D. Eisenhower met at the Summer White House in 1954 with Attorney General Herbert Brownell, Jr. (left) and FBI Director J. Edgar Hoover (right) to discuss an accelerated drive to “utterly destroy” the Communist Party. Hoover’s anti-communist credentials had been established as far back as the Roosevelt Administration, and his red hunting gained momentum during the Truman and Eisenhower presidencies. (AP-Wide World Photos)

Representatives Richard B. Vail and Harold H. Velde attacked Condon on the floor of the House, recounting the by-now stale accusations and adding some new ones.

Throughout this whole time Condon received the support of the staff. Some believed that he and his wife were perhaps indiscreet in their associations, but certainly no one believed they were in any way disloyal. But, by 1951 McCarthyism was reaching its peak. Investigations for security clearances from the Department of Commerce became more stringent, and some staff members were fired. Lauriston Taylor, who was the AEC coordinator for the Bureau, and through whose office went all AEC contracts, classified papers and security matters, recalls having to fire three persons.<sup>58</sup> One of them was quite a tragic case. His wife was a writer and had belonged to a book club, “and it turned out to be one of those Communist cells,” Taylor remembered.

I don’t recall now whether he knew that or not, but I’ll tell you, of anybody I ever knew in my life that was anti-Communist, he was it. He just got plain fired. This crushed him to the point where it broke his health. He went to a sanitarium and had a recurrence of some earlier lung problems and died. His wife committed suicide. That’s the story. It all tied into that security question.

<sup>58</sup> Conversation with Lauriston Taylor, April 10, 1990.

Taylor recalled two other cases of very able people who had to be fired, and in neither case were there any problems with the AEC. They had AEC clearance, but could not pass Commerce scrutiny. Similar accounts of two other persons are given by Jacob Rabinow.<sup>59</sup> One was another sad case. A patent attorney at the Bureau was reported to have said during the war that the Russians "were putting up a good fight." A hearing was held on his case, where Rabinow was a witness, and where, after some education of the committee by Rabinow on communism and what it was all about, the attorney was cleared. Nevertheless, the secretary of commerce immediately fired the attorney. He was devastated, but went into private practice and did quite well.

Equally troublesome was the problem of hiring. Because some potential applicants may have had some youthful peccadillos in their background, or perhaps simply because of the rigors of a loyalty and security investigation, many prospective candidates for positions would not even apply. Taylor recalls, "There were numerous cases of when you talked to people, just initial discussions about coming to the Bureau, and the security question would come up almost immediately. I've no way to document it, but I recall there were a number of cases where as soon as you got into the question, they sort of shrugged, 'Why get into this?'"<sup>60</sup>

This situation preyed on Condon. By the summer of 1951, his status with the Un-American Activities Committee looked as if it would never be resolved. McCarthyism was running rampant. On August 6, 1951, he wrote a four-page memorandum on loyalty and security procedures to President Harry S. Truman, with whom he had friendly relations.<sup>61</sup> The first page of the memo reads:

Actual operation of loyalty and security programs within the government, in the atmosphere of suspicion and hate engendered by some members of Congress, is producing bad results:

- (1) Nervous strain, legal expense and virtual blacklisting of individuals on trivial and silly charges which ought never to be given serious consideration.
- (2) Especially in science, the bad name which the Government is getting as an employer, is intensifying the problem of recruiting men to work on urgent problems. We have a critical shortage of scientists anyway which is made worse by these abuses.
- (3) The Administration is harming itself politically by admitting by its official actions that these individuals deserved removal. regrettably [sic] some actions taken may have been necessary, but many have not been necessary by any reasonable standards, and yet each such removal can also be attacked as an instance of earlier carelessness in hiring such people.

<sup>59</sup> Memorandum, Jacob Rabinow to Elio Passaglia, "Some Recollections on the Security Problems of the Early '50s," November 17, 1989.

<sup>60</sup> Taylor conversation.

<sup>61</sup> Memorandum to The President from E. U. Condon, director, National Bureau of Standards, August 6, 1951. (American Philosophical Society; Condon file; Teller box; Folder Truman #3. Used with the permission of the American Philosophical Society.) It appears that this memorandum was never sent. The copy in the files is an original rather than a copy, and it has typographical errors that would not be present in a final version.

The memo then goes on to document five cases supporting the statements he made.

The most interesting thing about the memo is its existence. Apparently Condon felt deeply enough about these questions of loyalty and security, and surely about his own problems, that he wrote about them to the highest official in the land. That the memo was almost certainly never sent does not lessen its air of desperation. Condon appears to have reached a turning point.

Two days later he wrote a letter to the president, and this one was sent.<sup>62</sup> The first paragraph of the letter reads, "I hereby submit my resignation as Director of the National Bureau of Standards, the position to which you appointed me in November, 1945. I would like to suggest that this resignation be made effective on September 30, 1951." The letter goes on to give his reason for resigning: "My own reason for leaving the Federal service is one that is all too familiar to you: I can no longer afford to accept the severe financial sacrifice involved." The letter also points out the importance of scientific work in the Government, and warmly thanks the president for his support. Two days later President Truman accepted Condon's resignation effective September 30, and the deed was done. Condon had resigned from the Bureau. He became director of research of the Corning Glass Works, Corning, NY.

It is interesting to consider Condon's reasons for leaving the Bureau. The reason of finances is often one used by a person leaving the Federal service, yet it is only very rarely the only one. In Condon's case, the juxtaposition of his memo to President Truman and his letter of resignation could be viewed as evidence that his personal problems with the House Committee on Un-American Activities, added to the wave of McCarthyism sweeping the country about Communists in Government, led him to conclude that it would be better for the future of the Bureau if he were to leave. This is the belief of many staff members at the time, although very few have any firm evidence. One of those is Lauriston Taylor. Taylor's father and Condon were good friends, and the families were fairly close at times. Taylor remembers a discussion in which one of Condon's big concerns near the end of his directorship was security and loyalty. Taylor remembers him saying "How much longer can I continue to fight this thing and drag the Bureau around in it, and see the reputations of other people hurt?" "He was almost asking, 'How long can I do this?'" Taylor added.<sup>63</sup> Considering all the evidence, it appears that Condon's problems with the HUAC were major factors in his decision to leave the Bureau.

Condon was always certain that the reason he was attacked by the Thomas subcommittee was that he served as scientific advisor to the McMahan committee during the formation of the AEC. On January 3, 1953, he wrote to Dean George B. Pegram at Columbia University:<sup>64</sup>

---

<sup>62</sup> Letter, E. U. Condon to President Truman, August 8, 1951. (American Philosophical Society; Condon file; Teller box; Folder Truman #3. Used with the permission of the American Philosophical Society.)

<sup>63</sup> Taylor conversation. Churchill Eisenhart recalled similar statements in an oral communication in 1990.

<sup>64</sup> Letter, E. U. Condon to George B. Pegram, January 3, 1953. (American Philosophical Society; Condon file; Security box 3; Folder Security Investigations, 1953, #2. Used with the permission of the American Philosophical Society.)

You know of course that the root of all my difficulty originates with active disagreement with General Groves and others about the nature of the legislation on atomic energy. I was fully cleared during the war for a wide variety of projects and remained in that status throughout my service in Washington despite the heavy and continuing political attacks on me with Groves' co-operation by the House Committee on Un-American Activities.



Lt. Gen. Leslie R. Groves, wartime head of the Army's atomic bomb project, was greeted by J. Parnell Thomas, chairman of the House Committee on Un-American Activities (HUAC), when he arrived to testify in a closed session in September 1948. Condon believed that his troubles with HUAC resulted from his disagreement with Groves and other members of the military about the proposed transfer of atomic energy to civilian control. (copyright *Washington Post*; reprinted by permission of D.C. Public Library)



Thus it appears that the battle over civilian control of atomic energy coupled with the Communist hunting frenzy of the postwar years, cost the Bureau its fourth director.

\* \* \*

Condon's security problems by no means disappeared upon his leaving the Bureau. In September 1952, the hearings he had long wanted were held. In six grueling hours he was questioned about all aspects of his background as it pertained to security, and particularly with his left-wing associations. The same old stories were brought up, but there were new ones as well, some dating back to his wartime days at Berkeley. It was an arduous experience. He denied—and the committee did not prove—that he was ever a Communist, had ever consciously known one, or had ever violated security matters. He was not totally believed by some members of the committee. Condon felt positive about the outcome. "This could have been cleared up if it was done four years ago—but better late than never."<sup>65</sup> In the committee's annual report, Condon was declared to be unqualified for any position owing to his "propensity for associating with persons disloyal or of questionable loyalty and his contempt for necessary security regulations."<sup>66</sup>

Then, on November 28, 1952, the Army-Navy Personnel Security Board tentatively denied him clearance for his work at Corning. He was given the opportunity to submit written material in support of himself, and on February 7, 1953, Condon submitted a twenty-one page document in his defense.<sup>67</sup> His security clearance was denied on February 16, 1953, but he appealed and his clearance was re-instated in July 1954. Three months later, in October 1954, the secretary of the navy suspended the decision and his clearance was again removed. The *New York Times* reported that Vice President Richard M. Nixon took credit for reversing the decision,<sup>68</sup> and in December the secretary of the navy denied that the vice president had anything to do with his actions. Now feeling that he was a liability to Corning, Condon resigned to accept a position as visiting professor at the University of Pennsylvania, and in 1956 he was appointed head of the physics department at Washington University in St. Louis. From Washington University he went to the University of Colorado where, in May 1966, after some fourteen years of fighting, his clearance was finally approved at the secret level so that he could carry out a project at the Joint Institute for Laboratory Astrophysics, a scientific partnership between the Bureau and the University of Colorado. It was an ironic ending to Condon's sad saga.<sup>69</sup>

<sup>65</sup> "Dr. Condon Declares He 'Cleared' Himself Before Red Probers," *The Washington Star*, September 6, 1952: A-2.

<sup>66</sup> Walter Goodman, *The Committee: The Extraordinary Career of the House Committee on Un-American Activities* (New York: Farrar, Straus, and Giroux, 1968): 252.

<sup>67</sup> Letter, Col. Harry W. Gorman to E. U. Condon, November 28, 1952. (American Philosophical Society; Condon file; Security box 3; Folder Security Investigations, 1953, #1); letter, E. U. Condon to Army-Navy-Air Force Personnel Security Board, February 7, 1953. (American Philosophical Society; Condon file; Security box 3; Folder Security Investigations, 1953, #3)

<sup>68</sup> Letter from E. U. Condon to Wayne Thornton, October 28, 1954. (American Philosophical Society; Condon file; Teller box; Folder Wayne H. Thornton)

<sup>69</sup> Some of this chronology comes from a letter Condon sent to C. P. Ives, Associate Editor of the *Baltimore Sun*, September 9, 1956. (American Philosophical Society; Condon file; Security box 3; Folder Security Investigations)

## ALLEN VARLEY ASTIN

Upon Condon's departure from the Bureau on September 30, 1951, Allen V. Astin, who was then an associate director, was appointed acting director. The National Academy of Sciences, acting on a request from Secretary of Commerce Charles W. Sawyer, recommended three persons, two from outside the Bureau and Astin from within, as possible replacements for Condon.<sup>70</sup> Sawyer selected Astin and sent his name to President Truman who appointed him on May 20, 1952. Upon Senate confirmation, Astin became the Bureau's fifth director on June 12—his forty-eighth birthday.

Astin was a decidedly different man from Condon, in background, personality, training, and experience. Unlike Condon, he was not a newcomer, having been at the Bureau since 1930. He had not had an easy life. He was born in Salt Lake City, Utah,



As the fifth director of the National Bureau of Standards, Allen Varley Astin's primary goal was to make the Bureau an attractive place for scientists to work. Committed to excellence, he developed a sense of mission and defined a mission, reduced the dependence of the Bureau on transferred funds, and made the Bureau's own appropriation the primary source of financing at a sufficient level to carry out that mission.

<sup>70</sup> House Committee on Appropriations, Subcommittee on Departments of State, Justice, and Commerce, *Departments of State, Justice, and Commerce Appropriations for 1955: Hearings before the Subcommittee of the Committee on Appropriations*, 83d Cong., 2d sess., National Bureau of Standards, 11 January 1954: 76. Testimony of Dr. Mervin J. Kelly.

on June 12, 1904. His father, John Andrew Astin, a school teacher, died when Allen was four, leaving behind a poor family of one son and two younger daughters, and their mother Catherine. The mother had to work to support the family, and Allen helped out. Beginning at the early age of eight he consistently held odd jobs—carrying newspapers, working on berry farms, digging ditches, and similar tasks. Totally disciplined, he was able to save enough money to enter the University of Utah, where he studied physics. He was a campus leader, edited the school newspaper, and met and fell in love with Margaret L. Mackenzie, a student one year behind him and a talented writer. An excellent student, he won a scholarship at New York University (NYU) and, upon receiving his B.S. degree, left for New York in 1925. After receiving an M.S. degree, he returned to Salt Lake City and married Margaret. The young couple returned to NYU, where Margaret also became a student, studying journalism. Upon finishing his Ph.D. in 1928, Astin was awarded a National Research Council Fellowship at The Johns Hopkins University, and the young couple moved to Baltimore where, in 1930, their first son, John Allen, was born.

When his postdoctoral appointment came to an end in that same year, Astin had a thesis and postdoctoral work on the dielectric constant of electrolytes, a wife and child, but no job, and jobs were not easy to find in that early Great Depression year. After an interview at the Bureau, he was offered a position as a research associate of the National Research Council with funds provided by the Utilities Research Commission of Illinois. For two years he studied the dielectric behavior of pure materials, picking up considerable experience in electronics and becoming well-liked by the Bureau staff.

But in 1932 the commission money ran out and Astin faced the prospect of being without a job, a situation that was made more tense by the birth of his second son, Alexander William. He was offered a position at the Bureau studying aircraft ignition on a Navy project, and in 1932 he became a full-fledged civil servant. In the almost ten years before the onset of World War II, Astin worked in the fiscally stringent but congenial and relaxed atmosphere of Lyman J. Briggs' 1930s Bureau. During this period he made significant contributions to the science of telemetry, applying these techniques to weather balloons used for cosmic ray studies; made important studies in the precision measurement of capacitance; and became an expert in electronics. During the war he was asked to turn his attention to the proximity fuze, and he became totally immersed in the effort throughout the whole war period. In 1944 he was made assistant chief of the Ordnance Development Division under Harry Diamond, the Bureau's inventive genius and good friend of Astin. When Diamond died suddenly and unexpectedly in 1948, Astin was made chief of the division, now renamed the Electronics and Ordnance Division. In 1951 he was made associate director of the Bureau, in charge of coordinating transferred funds programs in the Electronics, Ordnance Development, and Missile Development Divisions, as well as the program of the new Office of Basic Instrumentation. This was the position he held when Condon retired, and from which he became acting director, and then director.

Condon and Astin were as different in personality as they were in upbringing. Astin was not trained in the new physics as was Condon, and would be the first to admit that he was not the scientist that Condon was, although he could do things in the laboratory that Condon could not. Nor did he have the gregarious, assertive personality

of Condon. He was a friendly man, but low-key and rather reserved. He liked people, and people liked him because he listened and respected the opinions of others. A slender man with warm, friendly eyes, he never evinced anger, gave all questions serious consideration, and always appeared to be under the control of reason rather than emotion.<sup>71</sup> As a result his opinions were respected. Faced with an obstacle, his first reaction was not, like Condon's, to beat it down. He would try to finesse around it or wear it down, for one of his principal characteristics was tenacity. And while he may not have been on first-name terms with the world's leading scientists, he knew well the important actors on the Washington scientific scene, and understood the soft points of the bureaucracy. Outwardly calm and methodical, he did not lose sight of his goals and constantly worked toward them. Perhaps it can be said that Condon in his short six years got the Bureau started in the direction of modern science, and Astin took it there.

### FULFILLING A REPORT

When Astin became acting director, the Bureau was embroiled in the battery additive episode. Although while this area had been outside his jurisdiction while he was associate director, he now took personal charge of it. As a result of that episode, in late 1953 the Bureau had a report—the Kelly Committee Report—which provided Astin with an agenda for his immediate and future actions as director.<sup>72</sup> Formed as an “Ad Hoc Committee for the Evaluation of the Present Functions and Operations of The National Bureau of Standards,” the committee, chaired by Mervin J. Kelly, president of the Bell Telephone Laboratories, exhaustively investigated the Bureau and found an institution that was basically sound and of vital importance to the Nation. It had a “splendid record and tradition,” was “staffed with professional men of competence, integrity and loyalty,” and was needed more than ever as society became more technologically complex. But there were some significant problems.

First, the committee found that the Bureau's basic programs—the programs carried out with appropriated funds, rather than transferred funds—were in serious difficulty. The committee wrote:

Since the close of the war the technology of the nation has shot rapidly forward. The Bureau's basic programs expanded until 1950 but at a rate beneath that justified by the needs. Since 1950 the decrease in basic programs must be considered as tragic. The ground lost since 1950 should be regained in the next two fiscal years and the programs then expanded as detailed studies by the Director and his advisory committees find necessary.<sup>73</sup>

<sup>71</sup> Not that Astin could not get angry. His meeting with Laidler on July 29, 1952, should be recalled. Also, Astin had a whimsical side to his personality. Mrs. Astin tells the story of his having the children collect a jar full of live fireflies one summer evening. He then took the family to the local movie house, and during the performance released the fireflies. It made for an interesting audience reaction.

<sup>72</sup> *A Report to the Secretary of Commerce by the Ad Hoc Committee for the Evaluation of the Present Functions of the National Bureau of Standards: A Report on the Present Functions and Operations of the National Bureau of Standards With Their Evaluation in Relation to Present National Needs and Recommendations for the Improvement and Strengthening of the Bureau*, October 15, 1953. Mervin J. Kelly, chairman. Hereafter referred to as the Kelly Committee Report.

<sup>73</sup> *Ibid.*, 20.



In the midst of the AD-X2 affair, Mervin J. Kelly, president of Bell Labs and a member of the NBS Visiting Committee, chaired the Ad Hoc Committee for the Evaluation of the Present Functions of the National Bureau of Standards. The report of the Kelly Committee had a profound impact on subsequent programs at the Bureau.

Not that the Bureau was poor. Indeed, it was the richest it had been in its history, but the problem was that most of the funds were transferred from the military agencies and the Atomic Energy Commission. Thus, in FY 1953, the year preceding the committee report, the Bureau received \$7.4 million in appropriated funds, and \$40.1 million in transferred funds, with \$38.8 million, or 97 percent, of the transferred funds coming from the AEC and the military. Of the total expenditures of \$47.5 million by the Bureau, 83 percent were for work carried out for the AEC and the military. For the whole postwar period transferred funds had exceeded the base appropriation, and had shot up dramatically since the start of the Korean War. At the same time the appropriated funds had decreased, dropping (in current dollars) from \$8.7 million in 1950 to \$7.4 million in 1953, while transferred funds rose from \$ 11.3 million to \$47.5 million.

The large amount and nature of the work with transferred funds had some deleterious effects on the Bureau's basic programs. The sheer magnitude of the effort was harmful in that it caused great crowding.<sup>74</sup> Moreover, the requirements for security

<sup>74</sup> In FY 1953, the Bureau had an authorized staff of 4781, by far the highest in its history.

engendered a large administrative organization, and "brought about secrecy, limited freedom of movement and other restrictions and has created an environment that is not best suited to the basic programs."<sup>75</sup> Moreover, the rapid expansion of the military work increased the rate of advancement in the military programs as compared to the basic programs, so that personnel were actually siphoned from the latter. The Bureau had become an appendage of the military, and it was a time of penury amid plenty.

The committee also found that the AEC work and some of the military work was different in character from the rest of the military work. The AEC work—\$3 million in FY 1953—while often highly classified, was nevertheless laboratory work similar to the Bureau's work on its basic programs and often added to its capabilities; some of the military work fell into the same classification. This work was desirable and the committee felt that it should be continued. But the major bulk of the military work was concerned with the proximity fuze and guided missiles, and amounted to \$20 million in FY 1953, almost three times the Bureau's base appropriation. This work was pure weaponry development, and the committee felt that, except in time of war, it was not appropriate for the Bureau.

As a result of its study, the committee made ten recommendations:<sup>76</sup>

1. Higher level of activity in the basic programs.<sup>77</sup>
2. Modernization of facilities and increased space for basic programs.
3. Improvement of organization at the associate director level.
4. Transfer of weaponry projects to the Department of Defense.
5. Continued use of the Bureau by Department of Defense and Atomic Energy Commission for non-weaponry science and technical aid.
6. Continued and increased use of the Bureau by other agencies of Government in indicated areas of science and technology.
7. Decrease in repetitive test operations at the Bureau.
8. Division of primary responsibility for policy and procedure on commercial product tests between the secretary of commerce and the director of the Bureau.
9. Increased support of standard samples program.
10. Advisory groups to the director selected from membership in eight scientific and technical societies.

The first of these recommendations was the most difficult to carry out, and discussion of it will be delayed. The second was also difficult and, while it was partly alleviated by the acquisition and occupation of a site in Boulder, Colorado, it was not to be carried out until the move of the Bureau to new facilities in Gaithersburg, Maryland, in the mid-sixties.

---

<sup>75</sup> Kelly Committee Report: 10.

<sup>76</sup> *Ibid.*, 19.

<sup>77</sup> The word "basic" here is not used in the sense of basic (as distinct from "applied") research. Rather it refers to the basic functions of the Bureau as given in the Organic Act. Increases or decreases in the Bureau's appropriation add to or subtract from the Bureau's base appropriation which is the starting point for the yearly budget negotiations.

With respect to the third, the Bureau had four positions at the associate director level. There were associate directors for research, testing, ordnance development, and administration. The committee felt that, in the situation at the time the associate directors for the technical divisions functioned too much like "programmatic aides to the Director." This "ties the Director too closely to division supervision and places an unnecessary limit on the full use of the Associate Directors." Moreover, the position of associate director for research was too much for one person. It therefore recommended that the associate directors be given line responsibility "to the maximum extent possible," and that one more associate director be appointed. This was done immediately, and there were again four associate directors, in the areas of chemistry (Wallace R. Brode), physics (Robert D. Huntoon), testing (Archibald T. McPherson) and administration (Nicholas Golovin). Astin's old position of associate director for ordnance development was made unnecessary by the divestiture of the weapons work. However, removing the director from the direct administration of the divisions did not actually take place until the first complete reorganization of the Bureau in 1964, at which time the recommendation of the committee became moot.<sup>78</sup>

The fourth recommendation was accomplished in September 1953 with the transfer to the military of the three ordnance divisions and the missile development division, totalling 2000 persons. However, the amount of "other agency" work was so great that even in the fiscal year after this transfer, 76.6 percent of the Bureau's work was carried out on transferred funds. In that year the transfer of the military work was completed with the transfer of the Numerical Analysis Division in the Applied Mathematics Division to the University of California at Los Angeles. Known as the Institute for Numerical Analysis and located on the campus of UCLA, this division was totally supported by the navy and the air force. Nevertheless, the basic work would not exceed the transferred funds work until FY 1959.

Recommendations five and six are relatively obvious. The reasoning behind five has already been discussed, and six was because the committee felt that the Bureau did not do enough for agencies other than the military and the AEC.

While the Bureau performed an important and valuable service in developing methods of testing for various products, its talents were not well used in repetitive testing for purchase acceptance. The Bureau, following recommendation seven, did slowly decrease the amount of this work, but it would not be until the move to Gaithersburg that it would be discontinued. And the related recommendation eight was to give responsibility for the political aspects of product tests to the secretary of commerce, with the director retaining responsibility for the technical aspects. Clearly, this was meant to preclude recurrence of episodes like the battery additive controversy.

Recommendation nine was welcome, if routine, but number ten was a new departure. Under it, the scientific and engineering societies would appoint advisory committees in given areas such as metallurgy, chemistry, and mathematics. The committees would then visit the Bureau yearly, investigate the organizational units—usually a

---

<sup>78</sup> Kelly Committee Report: 5-6. Huntoon had been director of the Corona Missiles Laboratory and was brought back to Washington upon the divestiture of the weapons work.

division—responsible for that area, and advise the director on their findings about the program and its conduct.<sup>79</sup> This recommendation was adopted almost immediately, and from then on each division chief had to look forward to a yearly meeting with his peers who would report on his operation to his superior. It was designed to keep managers in touch with what was happening on the outside, and served a useful function. Gone, however, were the lax days of the old Bureau in which a division chief was essentially a lord in his fiefdom. This method of organizing advisory committees lasted until 1959 when the administration of the committees was taken over by the National Research Council.

But of all the recommendations, the first was the most important, and the hardest to carry out. It required that the appropriations from Congress be increased, and this was not happening. In fact, appropriations were decreasing.<sup>80</sup> In his first appearance before the House Appropriations Subcommittee in the spring of 1946—appropriations hearings for FY 1947—Condon won an increase from \$3.6 million to \$5.5 million.<sup>81</sup> This continued for the next two years, so that by FY 1949 the Bureau appropriation had increased to \$8.7 million. Then began an accelerating decrease, so that by FY 1952, Condon's last year, the appropriation had dropped to \$7.8 million. The next year—spring 1952—was Astin's first appearance before the committee as director. He tried a new approach. He tried to link the demands on the Bureau to the total number of scientists in the country, using the membership in scientific societies as an index, and arguing that this had grown much more rapidly than the Bureau's appropriation. The appropriation should rise at a comparable rate, he argued, and asked for a modest increase of \$0.9 million. To say that the committee was unimpressed would be euphemistic. In fact, they were shocked. Chairman John Rooney of New York, with whom Astin was to cross swords for many years, looked upon the Bureau's position as a statement that the Bureau should hire a constant fraction of the scientists in the Nation. Rooney was emphatic:

Dr. Astin, as far as I am concerned, you are just wasting your time and somebody has wasted a good deal of time in trying to put over an argument such as this, as to why personnel of the National Bureau of Standards should be increased. . . . As far as I am concerned, I am not going to appropriate any of the taxpayers' money based upon an argument such as this. Not one cent of it.

---

<sup>79</sup> The organizations represented were the American Institute of Electrical Engineers, the Institute of Radio Engineers, the American Institute of Physics, the Policy Committee for Mathematics, the American Institute of Mining and Metallurgical Engineers, the American Chemical Society, the American Ceramic Society, the American Society of Mechanical Engineers, and the National Conference on Weights and Measures. Later the American Standards Association and the American Society for Testing and Materials were added.

<sup>80</sup> A graph of the Bureau's appropriation over time is given in Appendix E.

<sup>81</sup> When appropriation figures are cited here, the appropriations for Plant and Construction are not included. These are one-time actions and do not add to the Bureau's base.



But Rooney closed the hearings on a somewhat conciliatory note:

In your first appearance before this committee . . . you started off with what might be called an unfortunate detail. However, now that you have concluded, I believe we all feel you have made a very interesting and fair presentation of the problems of the National Bureau of Standards."<sup>82</sup>

The Bureau received a cut of \$380 000. The following year (FY 1954, hearings in spring 1953) was the first Republican Congress that accompanied the Eisenhower victory, and it was a budgetary disaster. The Bureau's appropriation dropped a full \$1.7 million (23 percent) to \$5.7 million, its lowest point since 1947.

But the next year things began to change. The AD-X2 episode had now passed, and Astin was in a strong position. The Kelly Committee Report had been received, the transfer of weapons work had been made, and the Department of Commerce strongly supported the report and the Bureau's request for increases to strengthen its basic work. Secretary Sinclair Weeks used the Kelly Committee Report in his overall justification, Under Secretary Walter Williams presented and supported a 26 percent increase in the Bureau's appropriation, and perhaps most important, Mervin Kelly himself appeared before the committee and made a very strong impression.<sup>83</sup> There was, in the end, an increase of only 6 percent, but at least the string of decreases had been halted. Astin did not give up. He patiently but doggedly explained that the Bureau's appropriation should be increased because it could not now provide the services asked of it by science, industry, and commerce. The next year the increase was more substantial, amounting to 22 percent, and by 1957 the appropriation was \$8.4 million, almost as much as in 1949 and 1950.

Moreover, in 1956 an important change was made in the method of financing the Bureau. Before this, when the Bureau sold standard samples, or charged for calibrations or reimbursable administrative services, it did not receive the proceeds. Instead, these were sent to the Treasury. Thus the Bureau spent a part of its appropriation to perform these reimbursable services, but received none of the proceeds. In theory, funds for these functions were provided in the base appropriation, but it was not easy to coordinate income and outgo. In November 1956 a change embodied in Public Law 84-940, was made so that the Bureau was permitted to receive the income from its sales and services.<sup>84</sup>

It was not a small matter. In 1957 the receipts amounted to \$2.8 million, and part of the substantial increase in funds between 1956 and 1957 was due to this financing change. Indeed, the Appropriation Committee increased the appropriation by only

---

<sup>82</sup> House Committee on Appropriations, Subcommittee on Departments of State, Justice, Commerce, and the Judiciary, *Departments of State, Justice, Commerce, and the Judiciary Appropriations for 1953: Hearings Before the Subcommittee of the Committee on Appropriations*, 82d Cong., 2d sess., National Bureau of Standards, 18 January 1952: 432, 464.

<sup>83</sup> Appropriations Hearings for 1955: 5-6, 71-72, 75-82.

<sup>84</sup> Annual Report, 1956: 108; *AN ACT To amend the Act of March 3, 1901 (31 Stat. 1449) as amended, to incorporate in the Organic Act of the National Bureau of Standards the authority to use the Working Capital Fund, and to permit certain improvements in fiscal practices*, U.S. Statutes at Large, 70 (1956): 959.

\$1 million, but the funds actually available to the Bureau increased by \$3.8 million. It is highly doubtful that the committee would have provided this increase without the accounting change. In FY 1958, the year of the sputniks, the total available was \$12 million, an increase of 112 percent over 1954, Astin's worst year, but a much more modest 38 percent over its 1949 appropriation.<sup>85</sup> While the Bureau's total available funds—including transferred funds—had more than kept up with the national expansion in scientific research and development, its base appropriation, with which it maintained the leadership required in its unique position as the Nation's measurement standards laboratory, had fallen far short of requirements.

It is tempting to speculate on the reasons for the Bureau's steep drop in appropriations in the early years of the 1950s.<sup>86</sup> The economy-minded Eisenhower administration can be blamed for part of this, but the decline had started before the 1952 elections. At least a part of this must be laid to the inordinate amounts of transferred funds for weapons development the Korean War brought to the Bureau, as well as work required by the infant AEC. From the point of view of a Congressman, the Bureau was not a poor institution. It was, in fact, rich, if not fat. If it could not get money from the Congress it presumably could always contact one of its friends in the military. Representative Prince H. Preston of Georgia put it succinctly:

If we were to try to apply some economies . . . there would be nothing in the world to prevent the Bureau of Standards from doing a little staff negotiation with Navy, or somebody, and saying, 'Look, fellows, come to our rescue'. . . . The Navy would say, 'All right, we will give you a project'. . . . You would just be going to some other source to get the money we denied. I do not know what the answer is.<sup>87</sup>

And Preston made the point more clearly in 1956.<sup>88</sup>

MR. PRESTON: Is it a fact, doctor, that had you not performed this work for the agencies of the Government, that your direct appropriation would have been materially larger?

DR. ASTIN: Well, that is a difficult question. It might have been larger had we not had so many programs from other Government agencies.

---

<sup>85</sup> While the Bureau's base appropriation was not all for basic research, it is instructive to compare its growth with that of basic research expenditures in the Nation. Between 1953 and 1958, total national expenditures for basic research (in current dollars) increased by 100 percent, while total Federal Government basic research expenditures increased by 75 percent. Government in-house basic research expenditures, however, increased by only 25 percent over the same period. (Figures from the National Science Foundation, 1989.)

<sup>86</sup> The Bureau was not alone in experiencing a decline in research funds. Federal Government in-house expenditures for basic research showed a drop of 11 percent from 1954 to 1955. From 1953 to 1956, these expenditures increased by 3 percent, while the Bureau's appropriation was essentially unchanged.

<sup>87</sup> Appropriation Hearing for 1955: 91.

<sup>88</sup> House Committee on Appropriations, Subcommittee on Department of Commerce and Related Agencies, *Department of Commerce and Related Agencies Appropriations for 1957: Hearings Before a Subcommittee of the Committee on Appropriations for 1957*, 84th Cong., 2d sess., National Bureau of Standards, 20 March 1956: 101.

Subtle distinctions between basic measurement research and research for other agencies were hard to assimilate. Apparently it took the dramatic events of the AD-X2 incident, the Kelly Committee Report, and the consequent divestiture of the weapons work, to bring home to the Congress that the Bureau required support for its own unique mission. No amount of transferred funds would compensate for this lack of basic support, for inevitably and properly, other agencies were interested in carrying out their own programs, not those of the Bureau.

During the early fifties there were changes in how the Bureau carried out its accounting and in its method of presentation of its budget to the Congress.<sup>89</sup> The whole matter was complicated by transferred funds. Before FY 1956, the budget request was made in three line items: operation and administration (most of which, but not all, represented overhead), research and testing, and radio propagation and standards. The last was added to the budget request in 1949, two years after the Interservice Radio Propagation Laboratory was changed to the Central Radio Propagation Laboratory (CRPL) and was no longer a purely military function. When necessary, one-time items such as construction of laboratories were added. In 1950, there was formed a Working Capital Fund to put the Bureau's accounting system on a businesslike basis.<sup>90</sup> Along with this accounting system was a project system—installed in 1949 under pressure from the Congress—by means of which the costs of individual research projects could be calculated.<sup>91</sup> At the highest level the project system had five categories: fundamental research; applied research; development; testing, calibration and specifications; and general scientific services. There were nineteen second-level categories.

The system functioned by putting all funds into a Working Capital Fund and making all charges to this fund. In accord with customary accounting practice, it was recognized that administrative support activities were of general benefit to all the technical projects, hence these activities were considered as overhead. Their costs were distributed to the technical projects on the basis of the technical labor in the project. This then gave an accurate accounting of the costs of a technical project and formed a good cost accounting system.

Trouble arose with the operation and administration appropriation. If this was insufficient to cover the overhead costs, then money would have to be transferred from other line items, which represented technical work, to the overhead function. This would mean using funds appropriated for one function for another, and would be illegal. In the Bureau's case, the situation was complicated—and salvaged—by the presence of transferred funds. They did not have a stipulated amount of overhead,

---

<sup>89</sup> House Committee on Appropriations, Subcommittee on Department of Commerce and Related Agencies, *Department of Commerce and Related Agencies Appropriations for 1956: Hearings Before a Subcommittee of the Committee on Appropriations*, 84th Cong., 1st sess., National Bureau of Standards, 20 April 1955: 154-165. Astin's budget presentation gives the best description of these changes and procedures.

<sup>90</sup> *Deficiency Appropriation Act, 1950, U.S. Statutes at Large*, 64 (1950): 279.

<sup>91</sup> In 1952 the Bureau had 322 projects under its own appropriation, plus 350 unclassified projects carried out with transferred funds. There were, in addition, approximately 350 classified projects, all under transferred funds.

and saved the day. When all administrative costs for the Bureau were added up, they amounted to 31 percent of total expenditures. However, the portion of the appropriation for operation and administration that was allotted for overhead amounted to only 18 percent of the base appropriation. The Bureau thus developed the habit of charging the other agencies 40 percent overhead to make up the difference between the Bureau's appropriation and what it actually spent in overhead on its base program. In 1955, the comptroller general ruled that this way of operating was not legal, and the Bureau changed its manner of making budget requests. It did away completely with the line item on Operation and Administration. As long as this change was being made, the Bureau also eliminated the separate presentation for Radio Propagation and Standards. Hence the budget was presented according to the highest level of the Bureau's project structure, namely the categories of research; development; testing, calibration, and specifications; and general technical services. Construction and related expenses were carried as separate items. This restored legality and simplified both the presentation and the interpretation of the expenditures.

By FY 1958 the Bureau was beginning to show some of the effects of the changes brought about as a result of the Kelly Committee Report.<sup>92</sup> Most importantly, the fraction of transferred funds had been brought down to 58 percent, and in the next fiscal year the fraction would be lower than 50 percent for the first time since before World War II. The authorized staff had dropped from its high of 4781 in 1953 to 3200. And among the staff were a number of new hires who would have important roles in the future of the Bureau as division chiefs, and two who would become directors.

The divisions of the Bureau remained much the same. The three ordnance divisions and the missile development division were gone. The Electricity Division was combined with the Electronics Division, forming Electricity and Electronics. The Heat and Power Division became Heat, and Power disappeared. The CRPL was moved to the Bureau's new installation in Boulder, Colorado, and metamorphosed into three divisions: Radio Propagation Physics, Radio Propagation Engineering, and Radio Standards. And at Boulder there was a whole new division, Cryogenic Engineering.

By the end of FY 1958, approximately six months after the sputniks, the Bureau was well on the way to having reconstituted itself as the Nation's measurement standards laboratory. *Sputnik I* and *Sputnik II* would hasten the process.

---

<sup>92</sup> New criteria were adopted for the acceptance of other agency projects. Such projects were to "(1) have a close relationship to basic functions of NBS, (2) show prospect of producing results of general value to science, or (3) cannot be undertaken effectively elsewhere and do not require large changes in NBS staff. The application of these policies has resulted in discontinuance or significant decrease in a number of other agency projects." The excerpt is contained in a document entitled "Analysis of Program Conversion." The document, which consists of one page of text and seven of figures and charts, is unaddressed and undated and appears to have been an analysis to be used at a division chiefs' meeting with the Director. (NARA; RG167; Astin file; Box 20; Folder Corresp. 1958)

## THE ACQUISITION OF THE BOULDER SITE, AND A NEW PROGRAM IN CRYOGENIC ENGINEERING

In 1948, with about 3000 staff members on the Van Ness site, the Bureau was feeling crowded. Moreover, the conditions in the city were not suited for the work carried out in the Central Radio Propagation Laboratory, nor for guided missiles. The large amount of radio traffic in the surrounding city caused serious interference problems; the lack of an unobstructed horizon hampered the study of line-of-sight microwave propagation; and new frequency ranges became important in the postwar world of FM, television, and an ever-greater volume of communications. Equally important in influencing a move out of Washington was the government fear of an atomic bomb attack, which led to an effort to locate new facilities out of the city. Beginning in the late forties this effort culminated in a dispersal order by President Truman, which effectively precluded any expansion moves within Washington and eventually led to the move of all Bureau activities remaining at the Van Ness site to new quarters in Gaithersburg, Maryland. Thus, then-Director Condon sought new sites for the radio and missile work and asked the Senate Interstate Commerce Committee—which had jurisdiction over the Bureau, and whose chairman was Edwin C. Johnson of Colorado—for authority to build new facilities to house this work and to purchase land for them if necessary.

In October 1949, the Congress authorized \$4.5 million for “the construction and equipment of a radio laboratory building for the National Bureau of Standards” and \$1.9 million for a guided-missile research laboratory.<sup>93</sup> In both cases authorization to acquire land was also granted. With this authority the Bureau began investigating possible sites for the two new laboratories. The guided-missile laboratory was rather easily established on a former naval hospital site in Corona, California,<sup>94</sup> and was transferred to the navy in the 1953 divestiture. The settlement of the radio laboratory was more complex.

As stated by Condon,<sup>95</sup> there were two principal criteria for a satisfactory site on which to conduct both radio propagation and radio standards research; it must be “radio quiet” and be so located that long-distance, line-of-sight transmission was possible.<sup>96</sup> Accessibility and proximity to a university with strength in electrical

---

<sup>93</sup> *AN ACT To authorize the construction and equipment of a radio laboratory building for the National Bureau of Standards, Department of Commerce, U.S. Statutes at Large*, 63 (1949): 886; *AN ACT To authorize the construction and equipment of a guided-missile research laboratory building for the National Bureau of Standards, Department of Commerce, U.S. Statutes at Large*, 63 (1949): 905.

<sup>94</sup> MFP, 445.

<sup>95</sup> Conversation with Bascom W. Birmingham, September 17, 1990.

<sup>96</sup> Wilbert F. Snyder, Charles L. Bragaw, *Achievement in Radio; Seventy Years of Radio Science, Technology, Standards, and Measurement at the National Bureau of Standards*. Natl. Bur. Stand. (U.S.) Special Publication 555; October 1986: 526. It was for this latter reason that in 1950 an experimental transmitting tower was located at Cheyenne Mountain, near Colorado Springs, thereby effectively covering the Great Plains.

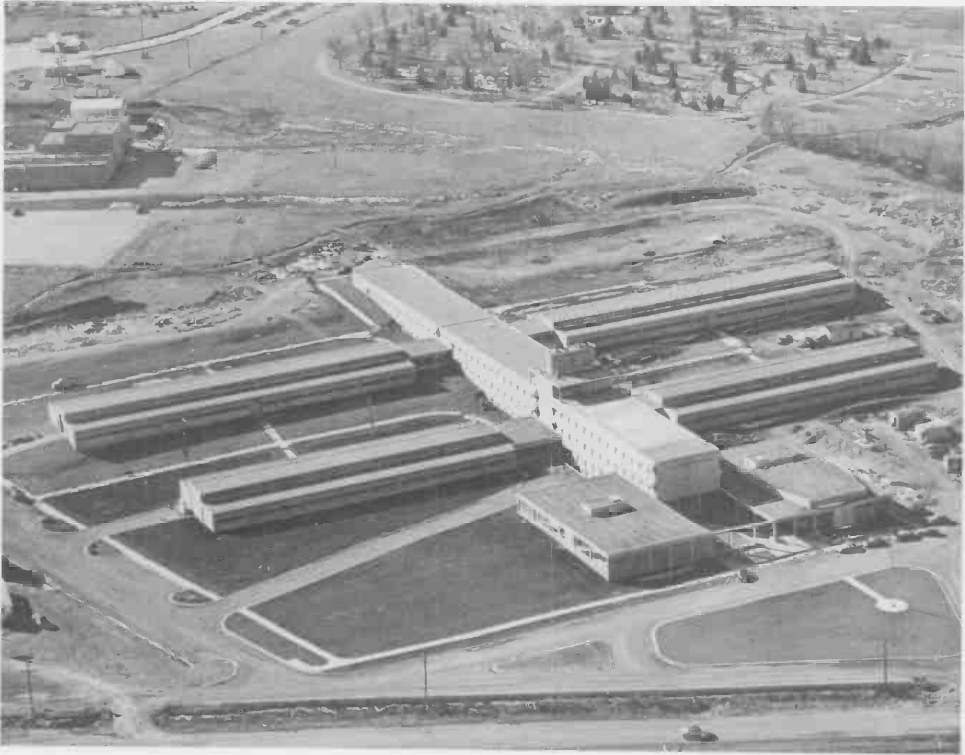

Air view of the NBS research center in Boulder, Colorado, taken in 1954. Upon completion, the structure in the foreground housed the Central Radio Propagation Laboratory. The buildings in the background (upper left) accommodated the NBS-AEC Cryogenic Engineering Laboratory.

engineering were also important considerations. Twenty-eight sites received consideration, all of them university towns,<sup>97</sup> but three of them stood out above the others: Boulder, Colorado, Charlottesville, Virginia, and Palo Alto, California.

With the news of its new authorization becoming quickly known, the Bureau was widely courted by places that would be prospective homes. But one city in particular—Boulder, Colorado—began an aggressive campaign to attract the Bureau and its projected \$2 million annual payroll. Indeed, even before the enactment of the authorization bill, Senator Johnson kept Boulder well aware of what was taking place.<sup>98</sup> And on the very day the bill was signed into law, Mr. Francis W. Reich, secretary-manager of the Boulder Chamber of Commerce, returned from Washington, “where he

<sup>97</sup> Newbern Smith, Kenneth A. Norton, Alvin G. McNish, and S. W. J. Welch, “Selection of Site for Proposed Radio Propagation Laboratory Building,” December 12, 1949. The authors constituted the Bureau’s Site Selection Board.

<sup>98</sup> “\$1,500,000 Electronics Research Lab of Bureau of Standards May be Moved Here,” *Boulder Daily Camera*, August 22, 1949: 1.

had been sent to push Boulder's qualifications," and had spent considerable time briefing Condon and other Bureau officials on the merits of Boulder.<sup>99</sup>

Adjacent to its southern boundary, but outside the city proper, there was a tract of land, mostly small farms, of somewhat over 200 acres. Immediately on Reich's return, he met with the Chamber of Commerce, which voted "to leave no stone unturned" to ensure that the Bureau laboratories would be attracted to Boulder. The Chamber thereupon took an option to purchase the tract, and one week later offered the site to the Government.<sup>100</sup> It was to prove a strong inducement.

While these various activities were taking place in Boulder, the Bureau's selection committee was meeting to decide on which site to recommend to the director. They selected three as suitable, and recommended that Boulder be chosen.<sup>101</sup> Part of the recommendation was that "A suitable tract of land . . . has been offered." Condon accepted the recommendation, and on December 12, 1949, Secretary of Commerce Charles Sawyer announced the selection, stating that construction would start in 1951 "on land donated by the Boulder Chamber of Commerce." There was jubilation in Boulder, and a congratulatory telegram from Senator Johnson to the Chamber of Commerce.

The Chamber was in a peculiar position. It had offered free to the U.S. Government a site it did not own, and on February 27, 1950, it began a campaign to raise the estimated \$70 000 needed to purchase it. With full-page ads laying out the advantages of the laboratories to Boulder, the campaign was a resounding success, and by April 25, 1950, had raised \$90 407. Boulder's plan to entice the Bureau had succeeded, and on June 14, 1950, in a ceremony in the Chamber of Commerce office, title to the 217-acre site was transferred to the Government. Now all that was necessary was that the Bureau's appropriation committees cooperate and provide the money to start the construction. The committees did cooperate and, after adjustment in conference, the appropriation bill—signed into law on September 6, 1950—provided for \$360 000 cash for engineering and design, and \$3.9 million in contract authority, for a total of \$4.3 million for the radio laboratory. In addition the Bureau received \$140 000 for design, and \$1.8 million in contract authority for modification of the naval hospital in Corona, California, into a guided-missiles laboratory. Work could now begin on the Boulder site, and the architectural firm of Pereira & Luckman of Los Angeles, and

---

<sup>99</sup> "Highlights of the History of NBS Move to Boulder From First Story of Possibility to Official Program," *Boulder Daily Camera*, September 10, 1954: 18. This was a special section of the newspaper, issued for the dedication of the Boulder Laboratories, commemorating the Bureau's move to Boulder.

<sup>100</sup> "Boulder Has Good Chance of Getting Big Laboratory," *Boulder Daily Camera*, October 25, 1949: 1; "Site for Bureau of Standards Laboratory Offered to Meet Any Competition of Other Cities," *Boulder Daily Camera*, November 2, 1949: 7.

<sup>101</sup> There are persistent rumors that Boulder was Condon's choice from the beginning, and this had some influence on the recommendation.

architect Robert Dietzen of Boulder were retained for the design of the radio laboratories.<sup>102</sup> The Bureau was on its way to having a permanent outpost at the edge of the Rocky Mountains.

But although the Boulder site had been acquired for the building of a laboratory to house the Bureau's radio research activities, the radio laboratory was not to be the first occupant of the site. Rather, the first facility was to be a cryogenic engineering laboratory for the production of liquid hydrogen.

The impetus for this laboratory came from national defense considerations. When President Truman announced at the beginning of 1950 that the Nation would build a hydrogen bomb, nicknamed "Super," the Atomic Energy Commission began a crash program.<sup>103</sup> Work on the Super had been going on at Los Alamos since 1942, and it had been realized from the beginning that the light elements were the most useful for fusion. This meant hydrogen and its isotopes. Also, it was realized that the fusion of two protons is qualitatively different from and much slower than either deuteron fusion or the fusion of a deuteron and a triton, and the problem with the latter reaction was that of obtaining sufficient quantities of tritium. Furthermore, tritium was highly radioactive. Attention was therefore focused on the deuteron fusion reaction. It was also realized at the beginning of this work that the higher the density of the reacting species the faster the reaction rate, hence *liquid deuterium* would automatically become the preferred initial state for the "fuel" in a first test. Thus Los Alamos had entered into cryogenics research, and by April 1944, a 35 liter/hour (L/hr) hydrogen liquefier had been built and tested.

Now, in 1950 with a crash program following the president's directive, the early Los Alamos work was re-examined, and it became clear that a cryogenic facility with "gas liquefaction plants and laboratories for engineering research and development at liquid hydrogen temperatures" was necessary. After looking at the various institutions that could carry such an effort, the AEC selected the Bureau to carry it out at "its newly acquired Boulder, Colorado, site," and a contract was entered into between the Bureau and the AEC.<sup>104</sup> Design work began under Ferdinand Brickwedde, Russell B. Scott, William E. Gifford, and Victor J. Johnson, and this group quickly expanded to

---

<sup>102</sup> House Committee on Appropriations. Subcommittee on the Department of Commerce. *Department of Commerce Appropriations for 1952: Hearings Before the Subcommittee of the Committee on Appropriations*, 82d Cong., 1st sess., National Bureau of Standards, 10 April 1951: 501.

<sup>103</sup> F. G. Brickwedde, E. F. Hammel, and W. E. Keller, "The History of Cryogenics in the USA": 14-15, 16, 19. Much of the early history of the liquid hydrogen production effort comes from this unpublished but definitive 1990 report. At the time in question, Brickwedde was chief of the Heat and Power Division in which all the Bureau's cryogenic research was carried out. Hammel and Keller were leaders of the Los Alamos National Laboratory Low Temperature Physics and Cryoengineering Group. We are much indebted to Bascom W. Birmingham for providing us with a copy of this report. This report was later published as chapter 11 of the *History and Origins of Cryogenics*, edited by R. Scurlock (Oxford University Press, 1992).

<sup>104</sup> Letter, E. U. Condon to Norris E. Bradbury, Los Alamos Scientific Laboratory, June 12, 1950. (NARA; RG 167; Records of the Director, 1923-63, Director's Correspondence file; Box 18; Folder Cryogenic Engineering, Laboratory for)



include Dudley B. Chelton, Bascom W. Birmingham, Richard H. Kropschot, Peter C. Van Arend, Robert B. Jacobs, and Robert L. Powell. A hydrogen liquefier with a nominal capacity of 350 L/hr was built and tested at the Van Ness site, and disassembled and shipped to Boulder.

Construction of buildings to house the cryogenic engineering program at the Boulder site began in 1951, and Birmingham was the first full-time employee in the program to arrive on the site in Boulder. A fresh recipient of a master's degree from the Massachusetts Institute of Technology, he was hired by Scott, arrived at the Van Ness site in late summer of 1951, and stayed one month. The rest of the cryogenic staff were experts in low temperatures, but were more familiar with laboratory equipment and operation than they were with the process engineering required for this large-scale effort. Birmingham, on the other hand, had such experience from previous employment, so it was only natural that he be the first to arrive in Boulder, which he did on October 9, 1951.<sup>105</sup>

By March 1952 the plant was in operation and, with a capacity of 320 L/hr, was then the world's largest liquid-hydrogen plant. Its hydrogen liquefiers and purifiers were in duplicate, making continuous operation much more likely. The liquefiers and purifiers were supplied with liquid nitrogen from two 10 000 L storage containers, which in turn were supplied by two commercial liquid-nitrogen generators, each capable of producing 250 L/hr. All of this was housed in a building of 14 000 square feet, with all necessary safety equipment and design. A separate building had 20 000 square feet for laboratory work, and the whole operation was denoted as the Cryogenic Engineering Section, with Scott as chief.<sup>106</sup> It became the Cryogenic Engineering Division in 1954.

It is interesting to note that the principal product for the AEC, namely liquid deuterium, was not produced by fractional distillation of the liquid hydrogen. Instead, it was produced by simply cooling gaseous deuterium—produced by electrolysis of heavy water—with liquid hydrogen. Since the boiling point of liquid deuterium is about 3 kelvins higher than that of liquid hydrogen, its condensation with liquid hydrogen is easily accomplished.<sup>107</sup>

Liquid deuterium from the laboratories was used as fuel in successful thermonuclear devices tested at Eniwetok Atoll in 1952. Before the tests could be conducted, a great deal of engineering was needed in such areas as transport dewars, *ortho*-to-*para* hydrogen conversion, transfer lines, improved insulation, properties of materials at low temperatures, seals, improved insulation, and others. Most of this engineering was done in the Cryogenic Engineering Laboratory. But it was clear that a final hydrogen bomb would not be fueled by liquid deuterium, yielding a so-called “wet” bomb. Rather, it would be the light compound lithium deuteride (LiD), and in 1954, tests showed that this “dry” bomb worked. Thereupon the AEC shut down completely the

---

<sup>105</sup> Interview with Bascom W. Birmingham, May 11, 1987: 2. NIST Oral History File.

<sup>106</sup> Annual Report, 1952: 14.

<sup>107</sup> In 1955, the Cryogenic Engineering Division began to develop a process for the fractional distillation of liquid hydrogen for the recovery of liquid deuterium.



Large reciprocating vacuum pumps in the hydrogen liquefaction plant of the NBS-AEC Cryogenic Engineering Laboratory. These pumps were used to reduce the boiling pressure—and hence the temperature—within the liquid-nitrogen precooler. Dean B. Berkly is shown opening the vacuum breaker on the first of the three vacuum pumps.

“cryoengineering component of the U.S. thermonuclear weapons development program.”<sup>108</sup> But before long the AEC needs would be supplanted by rocketry needs, therefore the Cryogenic Engineering Section, now the Cryogenic Engineering Division under Russell B. Scott, developed its own program.

Working on liquid-oxygen transfer systems, the flow of liquefied gases, the development of pumps for liquefied gases, the low-temperature properties of materials and, of course, the liquefaction of gases, the division had a well-rounded program in cryogenic engineering. One of its outstanding achievements—in cooperation with the University of California Radiation Laboratory—was the construction of a 500 L liquid hydrogen bubble chamber for use in high-energy nuclear research. Cryogenic engineering at the Bureau was well established.

While the Cryogenic Engineering Laboratory was under construction and then in operation, work on the radio laboratory did not cease. Following the appropriation of funds, design work began in the summer of 1951. Indeed, the Bureau sent out an “advance

<sup>108</sup> Brickwedde, et al., “History of Cryogenics in the USA”: 19.

guard" that summer to lay "the groundwork for the technical program and some of the field facilities which will be needed when we move." These personnel were housed in the Colorado National Guard Radar Armory just north of the city, and by January 1952 the Bureau had ninety-one staff members in Colorado, including those conducting tropospheric propagation experiments from Cheyenne Mountain near Colorado Springs.<sup>109</sup> A contract for the construction of the laboratory was awarded to the Olson Construction Company of Denver, and work began in late June 1952.<sup>110</sup> The laboratories were completed in March 1954, and the moves from the armory and from Washington to the new quarters began. When Frederick W. Brown, recently hired from the Naval Ordnance Test Station at China Lake, California, arrived as director on July 1, the Boulder Laboratories were established.

Except for some of the personnel from Washington who were unhappy about moving to Colorado, everyone was pleased with the new laboratories. The Chamber of Commerce sponsored a "Good Neighbor" trip to Washington where, on April 12, the party of thirty-six members met with Astin and Ralph J. Slutz, assistant director of CRPL, toured the laboratories, and met with many of the staff who were to be assigned to Boulder.

A dedication week was held September 8-14, 1954. Two full-scale scientific conferences—one on cryogenic engineering and the other on radio propagation—took place in the new laboratories as part of the festivities. But all other ceremonies were overshadowed by the dedication proper. With great praise for the Bureau, this was performed by President Eisenhower on September 14, 1954. In the terminology of the conference program, the Bureau had a "second principal campus."

#### POSTDOCS COME TO THE BUREAU

Joseph Hilsenrath joined the Bureau in 1948 under a unique joint appointment. In the Heat and Power Division, he was to supervise a project on thermodynamic tables, and in the Personnel Division, he was to develop a postgraduate training program for the NBS staff. In 1952 he entered into a conversation with David E. Mann, who had come to the Heat and Power Division as a spectroscopist in 1950 after postdoctoral fellowships at the University of Minnesota and at Harvard. Mann deplored the fact that the Civil Service system "was not geared to accommodate a transient population of postdoctoral fellows."<sup>111</sup> Because of his joint appointment, Hilsenrath knew about these matters and pointed out that there was a mechanism sanctioned by the Civil Service Commission (CSC) by which persons could be brought to work at the Bureau without going through a competitive appointment. Called Schedule A positions, these

<sup>109</sup> Appropriations Hearing for 1953: 452; Snyder and Bragaw, *Achievement in Radio*: 525.

<sup>110</sup> *Boulder Daily Camera*, "C. U. Man Named Consultant for Standards Bureau," May 22, 1951: 2; "Construction of Cryogenics Lab Nearly Finished," June 25, 1952: 2; "Excavation for Radio Laboratory to Start Monday," June 28, 1952: 4.

<sup>111</sup> Joseph Hilsenrath, *The National Academy of Sciences-National Research Council's Postdoctoral Research: An Account of Its Origin and Early History at the National Bureau of Standards*. Natl. Bur. Stand. (U.S.) NBS/GCR-85/500; September 1985: 4.



President Dwight D. Eisenhower stepped down into a lobby of the new Radio Building of the NBS Boulder Laboratories, accompanied by (left to right) Governor Dan Thornton of Colorado; Allen V. Astin, director of the National Bureau of Standards; Frederick W. Brown, director of the Boulder Laboratories; and Secretary of Commerce Sinclair Weeks.

positions were, however, limited to (1) university faculty for a maximum of 120 days a year, (2) qualified consultants for a maximum of 180 days a year, and (3) graduate students at an accredited college or university. Perhaps this authority could be extended to postdoctoral fellows.

Both Hilsenrath and Mann were convinced that there were places in the Bureau where high-quality doctoral recipients would find the atmosphere and facilities necessary for them to effectively continue their research training, and a constantly renewed population of fresh, young minds would be of inestimable value to the Bureau. Both men felt that the program should be modeled after the National Research Fellowships funded by the Rockefeller Foundation and administered by the National Research Council, and if the NBS fellowships could be made into NRC Fellowships, they would gain great prestige and attract high-quality students.

Although no longer attached to the Personnel Division, Hilsenrath was a member of the Bureau's Education Committee and began to explore the possibilities. He contacted Personnel, which in turn called the CSC to see if there was any interest in, or antagonism to, such a proposed program. After receiving an encouraging response, Hilsenrath approached several division chiefs to see if their interest extended to providing funds. Four did—Heat and Power, Chemistry, Atomic Physics, and Applied Mathematics.

Approval was readily obtained from the Bureau administration to continue the exploration and the next step was to approach the NRC to determine if it had any interest in the matter. Now serendipity took over. In January and February 1953, the Bureau representatives found the NRC not only willing, but anxious to make an arrangement. The approach by the Bureau had come at a time when the NRC had been notified by the Rockefeller Foundation that it would no longer support the National Research Fellowships in the physical sciences. The NRC had been administering these prestigious fellowships since 1919, and was on the verge of having to eliminate them; its staff were glad to talk to the Bureau.

On March 16, 1953, a letter from Wallace R. Brode to Claude J. Lapp of the NRC made the matter formal, and from then on everything went smoothly; the NRC was happy to enter into a joint postdoctoral program with the Bureau. Indeed, for the 1953-1954 competition—the last year of Rockefeller supported fellowships—the NRC had forty-six applicants for eight university positions, and permitted the Bureau to see applications of four of those not chosen. The Bureau selected one of them—Janet Hawkins Meal, a spectroscopist from Harvard—and offered her a position with Mann. Except for the NRC screening, this was a noncompetitive (Schedule A) position, and it was described as a postdoctoral position, even before the CSC had approved such positions. Meal came to the Bureau in December 1953 and became known as the “zeroth postdoc.” But CSC approval was forthcoming and on June 25, 1954, Commission Chairman Philip Young informed the director of personnel of the Department of Commerce that the commission had approved the Bureau's request to place postdoctoral positions under Schedule A. The Bureau was authorized to fill up to ten such positions.

There was, however, a slight problem with the title. The holders of these positions would have to pay income tax, whereas the universities wanted to reserve the name “fellowship” for positions that did not require the payment of income tax. The name of the position was therefore changed to “postdoctoral research associateship,” and the positions were so advertised. The 1954 announcement, sent to university deans, professional societies, and leading scientific journals, read, “Announcement of the National Research Council-National Bureau of Standards Postdoctoral Research Associateships in Chemistry, Mathematics, and Physics, 1955-1956, recommended by the National Academy of Sciences-National Research Council.” Thirteen areas of research in which positions were available were listed. Appointments were for one year, renewable for another, and were at the GS-11 grade level, paying \$5940 per year. The announcement attracted twenty-one applicants. Their applications were rated by three NRC selection boards and the Bureau was constrained to select candidates in each field in the order in which they were rated. Seven applicants accepted positions, but one did not obtain his degree in time. In August 1955, the first NRC-NBS postdoctoral research associate arrived at the Bureau.

The program grew and flourished. In 1958 Director Astin made funding for the program a line item in the budget and, since division funds were no longer involved, competition for associates became keen among divisions. Rules were laid down: no more than two associates per division, but this was later relaxed when the yearly number of associates was increased to twenty. The original disciplines of physics, chemistry, and mathematics were augmented periodically, so that by 1983 there were nineteen, including astronomy and astrophysics, life sciences, geology, materials science with its divisions of metallurgy and ceramics, and all the engineering disciplines. Between 1955 and 1983, 2680 applications had been received, and 505 positions awarded. Other Federal Government agencies followed the Bureau's lead. A year after the Bureau received its first associates, the Naval Research Laboratory installed its own program with the NRC, and by 1985 some thirty-five Government laboratories had one of several types of postdoctoral research associate programs with the NRC.

It is difficult to overestimate the importance of this program to the Bureau. The original premises that fresh Ph.Ds could find valuable projects to carry out at the Bureau, and that the infusion of these intelligent, questing young minds into the Bureau would be a constant source of stimulation to the permanent staff, were amply borne out. Due to the method of selection, these were, after all, some of the brightest and most gifted students of their generation. Perhaps most important, the postdoctoral associate program became the preferred method for the Bureau to hire new staff.

#### AN INSTRUMENTATION PROGRAM

Instruments for measurement have always been at the heart of experimental science, and scientists often have to devise special instruments for the measurements they want to make. Indeed, in 1923 the Institute of Physics (U.K.), with assistance from the National Physical Laboratory—the British counterpart of the National Bureau of Standards—began publishing the *Journal of Scientific Instruments*, comprised of scientific papers on new instruments. This publication was followed in 1930 with *The Review of Scientific Instruments*, published by the Optical Society of America. *Instruments: Industrial and Scientific*, published in 1928, was limited largely to descriptions of industrial instruments.<sup>112</sup>

By the end of World War II instrumentation was a flourishing activity. So many new techniques of measurement had been devised that the ordinary laboratory scientist could not keep up with them. A new type of scientist had developed, one who was primarily interested in how to measure phenomena, rather than on what the measurements meant. Moreover, feedback control systems had shown great development during the war, so that it was possible to think of instruments embedded into a control loop, leading to a "science of measurement and control." The science of instrumentation had been born. It recognized that measuring instruments generally had features in

---

<sup>112</sup> W. A. Wildhack, "Instrumentation in Perspective," *Science* 112 (1950): 515-519.

common—transduction, signal amplification, recording—no matter what the phenomenon measured, and this provided a basis for a new scientific discipline.<sup>113</sup> A new society, the Instrument Society of America, was formed in 1945, and instrument design, production, and selling became a new industry.

It was only natural that the Bureau, whose business was measurement, and which had devised many instruments, should consider developing a program in instrumentation. The champion of the program was William A. Wildhack, chief of the Missile Instrumentation Section. He convinced Condon of the merits of such a program and, effective June 1, 1950, an Office of Basic Instrumentation was established in the Office of the Director.<sup>114</sup> Funds were received from the Office of Naval Research, the Air Research and Development Command, the AEC, and NBS. With the principal objectives of systematically analyzing available methods and devices in terms of their performance and characteristics, and performing research on new applications and materials leading to new types of instruments, the Office of Basic Instrumentation worked by assignment of projects to those Bureau laboratories best qualified to conduct research in the particular field in question. The office did, however, maintain a small laboratory staff to work on special problems, and a group of specialists in instrumentation literature to develop a reference and consultation service.<sup>115</sup> As head of this office, Wildhack appears to be the first person in the Bureau's history to be what was later called a "program manager," a person with essentially no resources (personnel) to carry out work but who, either by personal persuasion or with funds available to him, induced line managers to carry out work for his program. After its formation the activities of the program were reported as a line item in the annual report.

There followed a profusion of instruments. Six examples, essentially picked at random, were an electron-beam interferometer, a miniature piezoelectric accelerometer, a thermal noise thermometer, a sensitive calorimeter for measuring the power of an x-ray beam, an instrument for measuring very small alternating currents such as those encountered in transistor circuitry without breaking the circuit, and an improved galvanometer design which optimized sensitivity and speed of response. By 1953, a bibliography of some 250 books and periodicals on important techniques had been compiled.

In 1960 the office was formed into the Instrumentation Division with five sections under G. Franklin Montgomery, with the functions of investigating "[t]he natural limitations of the measurement process, and the realizable performance of measuring instruments."<sup>116</sup> It kept a large reference file on instruments and measurement methods.

---

<sup>113</sup> An excellent analysis of this topic is given by E. U. Condon, "Is There a Science of Instrumentation?" *Science* 110 (1949): 339-342. Condon arrived at a positive answer to his question.

<sup>114</sup> U.S. Department of Commerce, National Bureau of Standards, Bureau Order No. 50-14, June 8, 1950, signed by E. U. Condon. (NARA; RG 167; Astin file; Box 19; Folder Corresp 1950)

<sup>115</sup> "Basic Instrumentation at NBS," *Technical News Bulletin* 37 (1953): 129-133.

<sup>116</sup> Annual Report, 1960: 100. The sections were Engineering Electronics, Electron Devices, Electronic Instrumentation, Mechanical Instruments, and Basic Instrumentation.

## THE TECHNICAL WORK

In its study of the Bureau, the Kelly Committee evaluated all seventeen of the Bureau divisions and was concerned particularly with their ability to carry out basic research relating to the Bureau's unique measurement-standards responsibility. Not all divisions were equally capable of carrying out this responsibility. Indeed, for four divisions—Ordnance Development, Ordnance Electronics, Electrochemical Ordnance, and Missile Development—the point was moot, for these were the ordnance divisions entirely supported by the Department of Defense and working totally on weapons development. After their divestiture in 1953 following the committee's recommendation, thirteen divisions were left at the Bureau. These showed wide diversity in the amount and character of basic program work carried out, and the response of the Bureau's management to the Kelly Committee Report is well summarized in the Annual Report for 1955:<sup>117</sup>

During the past year, the major effort of the National Bureau of Standards has been devoted to the strengthening of its basic programs. With the assistance of scientific advisory committees, the Bureau is seeking to develop a balanced technical program by increasing the level of research, especially basic research, in those fields for which the Bureau has an assigned responsibility.

An effective standards research program must at all times remain at the forefront of science.

This management aim was carried out during the fifties with differing degrees of success in the various divisions.

This section is a short synopsis of the work carried in the period 1950-1957 in each of the divisions, with occasional, more extended vignettes on particularly noteworthy accomplishments. The aim is to illustrate by example the nature of the division's work, and how it changed during the period, if it did. Most of the material is taken from the Annual Reports and, when it is, citations are omitted to reduce what would otherwise be an inordinate number of footnotes.

## ELECTRICITY; OPTICS AND METROLOGY

Two divisions in particular were concerned with fundamentally important standards—Electricity, under Francis B. Silsbee, and Optics and Metrology under Irvine C. Gardner. In the committee's opinion they were in need of attention so that they could meet the requirements of modern science.<sup>118</sup> Not that they were not capable of providing the calibration services they were accustomed to; the problem was that they

---

<sup>117</sup> Annual Report, 1955: 1.

<sup>118</sup> Kelly Committee Report: 24, 30.



were not advancing into new and required areas as fast as the Nation demanded. This situation had come about from lack of funds in the base appropriation, leading to far too great a proportion of transferred funds, and also from the heavy pressure for calibration. The latter problem was exacerbated by the age of the calibration equipment, which made the whole calibration process very slow, particularly in length calibrations carried out in the Optics and Metrology Division. Investment in the divisions had not been equal to the need.

This did not mean that the people were incompetent in their jobs. The calibrations were done well, if slowly, and the testing and calibration of instruments was extended into wider ranges. For example, measurements of voltage and current had to be made over an ever-expanding frequency and voltage range, and in the early fifties the range over which ammeters and voltmeters could be calibrated was expanded to 50 A and 400 V at frequencies up to 20 kHz. Similarly, new means of measuring resistors of extremely high resistance were developed, as well as equipment for more rapid calibration of watt-hour meters. Likewise, in Optics and Metrology numerous length calibrations, ranging from 10  $\mu\text{m}$  to 50 m, were carried out; the working meter bar standards were intercompared and periodically compared with the legal national prototype meter, which, in turn, was compared with the international prototype meter at the International Bureau of Weights and Measures (BIPM); and end standards (gage blocks) were measured by interferometry using accepted spectral wavelengths. A number of end standards were also compared with line standards (standard meter bars) to verify the wavelength of krypton in preparation for the proposed change in the definition of the meter from the platinum-iridium meter bar to the wavelength of krypton light.

There were other measurements and standards to be re-evaluated. The output of lamps that served as the national standards for the photometry of mercury-vapor lights was redetermined with a photometer embodying a thermopile and accurate luminosity filters and found to be rated too low, so that their output had to be reassigned. Color standards and measurements of various kinds—for petroleum, for the color measurements needed for color television cathode-ray tubes, and for the determination of color differences—were issued or carried out throughout the period.

Both divisions carried out other work that was less directly tied to standards, although measurement methods were generally involved. Practically all of this work was supported by other agencies. The Electricity Division, working for the Rural Electrification Agency, utilized its high-voltage laboratory to test large ceramic insulators used for electric-power transmission. The obtained data enabled the re-design of the insulators, thereby reducing the possibility of failure during nearby lightning strikes. And the division, embroiled in the AD-X2 affair, nevertheless continued the development of various kinds of batteries for military agencies. The Optics and Metrology Division maintained a full program devoted to photography, including the issuance of useful charts for the determination of the resolution of photographic lenses; designed and built optical components such as interferometers; and used the SEAC to pioneer the use of computers for ray-tracing in lens design.

Then, upon the divestiture of the ordnance divisions in 1953, the Electronics Division was merged with the Electricity Division, becoming Electricity and Electronics under Silsbee, and a whole new set of activities was added to the division's program. This addition, more concerned with electronic equipment than basic electrical standards, introduced programs in circuits and circuit design, electron tubes, resistor noise, and electronic reliability. Under sponsorship from the military and other agencies, this component of the Electricity and Electronics Division turned out a profusion of electronic devices and instruments. To list but a few, there were:

- A vibration generator that operated at 100 Hz to 10 000 Hz for testing vacuum tubes for microphonics.
- A device to measure the error voltage in servo-feedback systems.
- A liquid-level indicator and control system, built for the Boulder Cryogenic Engineering Laboratory.
- FOSDIC (Film Optical Scanning Device for Input to Computers). Built for reading Census forms in which each answer to various questions consisted of a dark mark in one of several positions, the device read the position of these marks on a microfilmed copy of the form and converted the information to pulses on magnetic tape for subsequent input into an electronic computer. It was capable of reading 10 million answer-positions per hour.
- A physiological monitor. Built for the Veteran's Administration, this instrument automatically sensed the blood pressure, heartbeat, and respiration of a patient under anesthesia, and presented the data on a panel for the physician. This appears to be one of the first such now-ubiquitous instruments.
- A high-speed coin-weighing machine built for the Treasury Department that could weigh 18 000 coins per hour.
- A free-floating weather buoy built for the Navy, and later made operable in hurricanes. With a range of 800 miles, every 6 hours the buoy broadcast data on wind direction and velocity, barometric pressure, air and water temperature, and an identification symbol. It could be left unattended for 3 months.
- A very compact oscilloscope. Built as part of a continuing Navy program on the miniaturization of electronic components, various portions of the electron-tube circuit could be replaced with transistor assemblies to compare the performance of the vacuum tube and transistor circuits.

While these projects—and many more that could be mentioned—aptly illustrate the Bureau's role as the "corporate laboratory" of the Government, perhaps the most famous of the Electronic Division's programs during the period, Project Tinkertoy, was one of modular design and mechanized production of electronics. Oddly enough, despite its concern with the miniaturization of electronic components, the division did not have a program in transistors, although it used them in 1957 to build a cordless microphone for auditorium use.

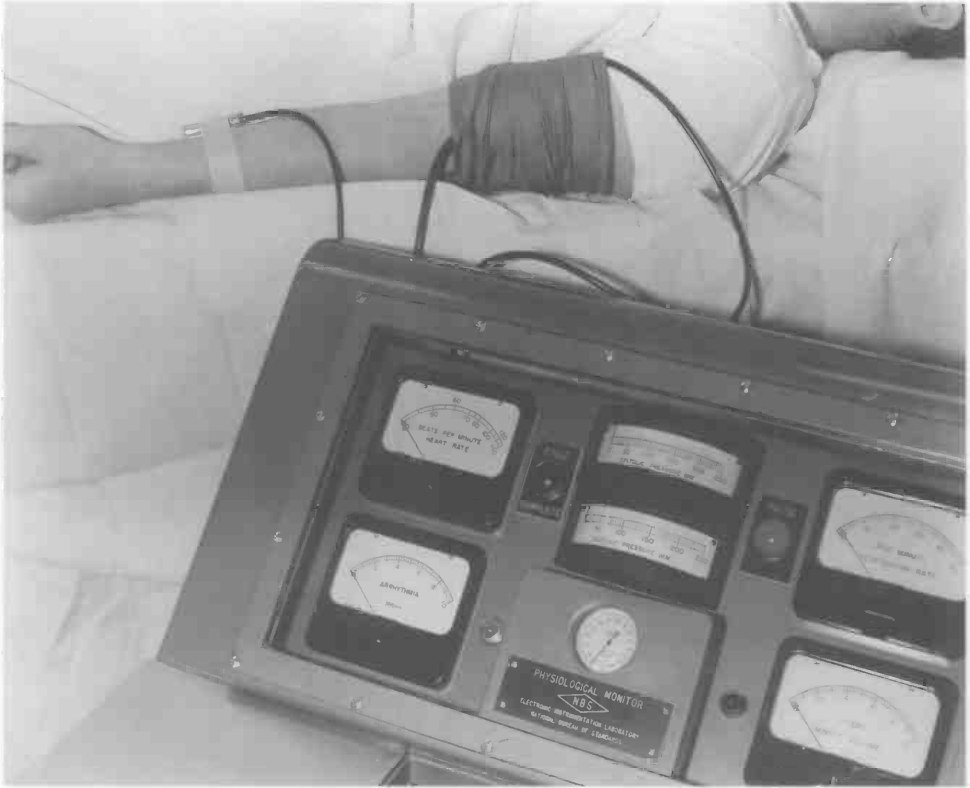

A physiological monitor, built by NBS for the Veteran's Administration, shows panel board and attachment to the subject's arm. One of the electrodes, for measurement of heartbeat, was attached to the wrist, while the inflatable band for measurement of blood pressure was applied to the upper arm.

The performance of all this practical work did not mean that these divisions lacked the capability—or the desire—to carry out world-class measurement-standards work on the basic units. Indeed, one beautiful experiment in the Electricity Division illustrates the class of work that could be done. This was the experimental realization of the absolute ampere, and it was neither an idle exercise nor a vain display of metrological virtuosity. In 1950, the legal basis for electrical standards in the world had changed. Before this date, the basis was the so-called international system of electrical units in which, for example, the ampere was defined as the amount of current that would deposit 1118  $\mu\text{g}$  of silver in 1 second. Congress had adopted these units as the legal standards in 1894.

As measurement technology progressed, it became possible to make precision measurements that defined the electrical units in terms of the mechanical units of mass, length, and time. This possibility arises because two parallel wires carrying current experience a force, and therefore—in principle—the measurement of this force and the distance between the wires can relate the unit of current to the unit of force, hence

to the units of mass, length, and time. Similarly, the ohm can be defined on the basis of the inductance of a coil, which involves the measurement of lengths and a frequency. The definition of the ampere in terms of these mechanical units therefore leads to a unified measurement system, and the quantities based on it—ampere, ohm, volt—were called absolute quantities. In 1950 the Congress adopted the new units as the legal basis for electrical measurements in the United States.<sup>119</sup>

Before the adoption of these new units, the electrical units at the Bureau were maintained by a set of standard cells and standard resistors, with the ampere “as maintained” defined on the basis of these artifacts. The question had naturally arisen as to how the United States ampere as maintained by the Bureau was related to the absolute ampere. Absolute measurements are hard to make; before 1950 only four realizations of the absolute ampere had been made at the Bureau, the first in 1912 and the last in 1942.<sup>120</sup> These were all based on the so-called Rayleigh current balance. In this balance, three coils—two large and one small—are arranged coaxially and current is passed through them. Under the proper geometric arrangement, a force is developed on the small coil. The force is proportional to the current, and depends on the dimensions and geometric placement of the coils. The force per unit of current can be calculated from first principles knowing the dimensions of the coils and their geometric arrangement. The force is easily measured by suspending the small coil from the arm of a balance, with the dimensions and geometry measured as accurately as possible. But the measurements are very tedious, the forces small, and the experiments very sensitive to disturbances. Nevertheless, uncertainties of a few  $\mu\text{A}/\text{A}$  were attainable. Indeed, the 1939 measurement led to the result that one NBS international ampere was equal to 0.999 860 absolute ampere, while the 1942 result for the same quantity was 0.999 850—a value that was adopted by the international community. The units of the volt and the ohm as maintained by NBS and the other national standards laboratories were adjusted for this difference on January 1, 1948. But it was not until 1950 that the United States legally changed the absolute units.<sup>121</sup>

But routine calibrations were not made with the current balance; they would have been prohibitively expensive and time-consuming. They were made on the basis of standard resistors and electrochemical cells. And the question arose, “Has anything

---

<sup>119</sup> AN ACT To redefine the units and establish the standards of electrical and photometric measurements, *U.S. Statutes at Large*, 64 (1950): 369.

<sup>120</sup> E. B. Rosa, N. E. Dorsey, and J. M. Miller, “A Determination of the International Ampere in Absolute Measure,” *Bulletin of the Bureau of Standards* 8 (1912): 269-392; H. L. Curtis and R. W. Curtis, “An Absolute Determination of the Ampere,” *Bureau of Standards Journal of Research* 12 (1934): 665-735; H. L. Curtis, R. W. Curtis, and C. L. Critchfield, “An Absolute Determination of the Ampere Using Improved Coils,” *Journal of Research of the National Bureau of Standards* 22 (1939): 485-517; R. W. Curtis, R. L. Driscoll, and C. L. Critchfield, “An Absolute Determination of the Ampere Using Helical and Spiral Coils,” *Journal of Research of the National Bureau of Standards* 28 (1942): 133-157.

<sup>121</sup> *Announcement of Changes in Electrical and Photometric Units*. Natl. Bur. Stand. (U.S.) Circular 459; May 1947. The changes were not trivial. They amounted to increasing the value of the ohm and the volt by 495 ppm and 330 ppm, respectively.



Prior to 1954, all four determinations of the absolute ampere had been based on the Rayleigh current balance. In the classic experiment of Rosa, Dorsey, and Miller (1912), a series of nearly 500 measurements determined the absolute ampere to be slightly larger (4 parts in 100 000) than the international ampere determined by silver voltmeters.

drifted in this system so that the maintained ampere no longer has the same relationship to the absolute ampere?" In 1954, while the division was still feeling the effects of the AD-X2 incident, Raymond L. Driscoll set out to answer it by making yet another determination of the absolute ampere. To ensure that his results would properly answer the question, he used a different method for the measurement, the so-called Pellat balance. While the Rayleigh balance measures forces on coaxial coils, the Pellat balance is based on the measurement of torques on current-carrying coils with their axes at right angles. For this purpose, a small coil is placed inside a long solenoid

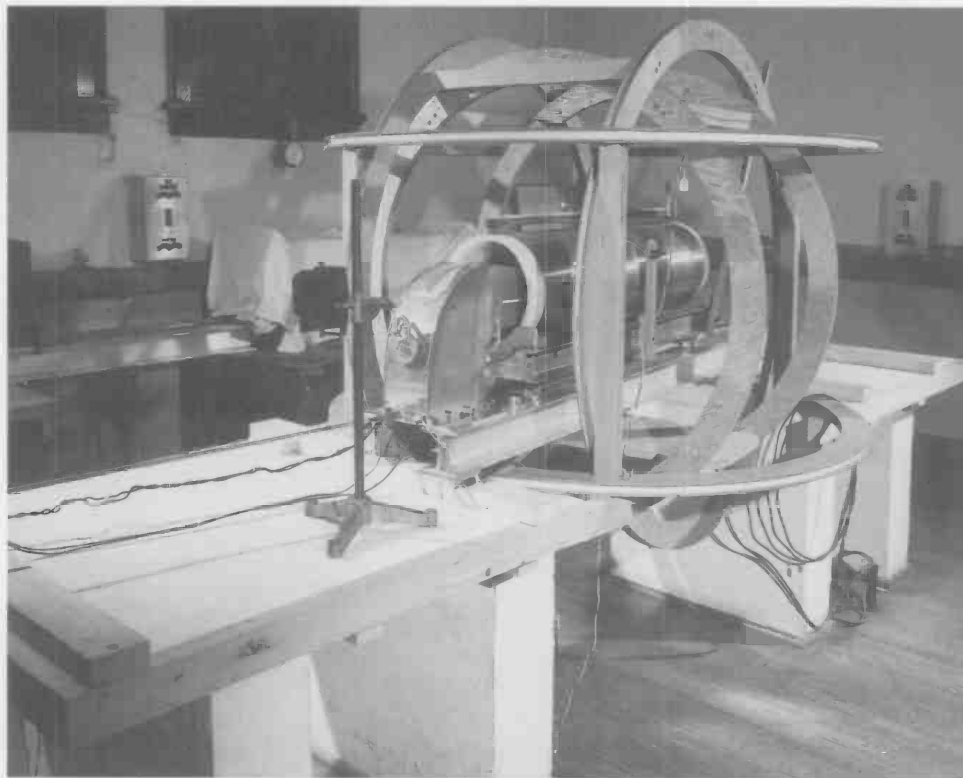

Electrodynamometer used in the absolute determination of the NBS ampere in 1954 by Raymond L. Driscoll. The metal housing that entered the large solenoid contained a small rotatable coil and a balance arm. When the direction of the current through the coils was reversed, a torque was produced on the small coil. The coil was connected to the balance arm and, as it tended to rotate, equilibrium was upset. Balance was restored by adding known weights to the balance arm by means of the rod-and-pulley arrangement at the outer end of the housing. From the known weight, the length of the balance arm, and the geometry of the windings, the value of the current in amperes could be calculated in terms of length, mass, and time. The framework surrounding the apparatus contained coils to compensate for the earth's magnetic field.

with its axis orthogonal to that of the solenoid. Current is passed through the two coils and the torque on the small coil measured, again using a balance and an ingenious jig to support the small coil. New coils had to be designed and made, an excruciating task in itself. The whole arrangement had to be kept in an isolated room, with control only via long control rods. Four years later Driscoll<sup>122</sup> published his results. They were the same as the 1942 results with an uncertainty of  $6 \mu\text{A}/\text{A}$ . To cement the results further, Driscoll and Robert D. Cutkosky repeated the 1942 work of Roger W. Curtis, Driscoll,

<sup>122</sup> R. L. Driscoll, "Measurement of Current with a Pellat-Type Electro-dynamometer," *Journal of Research of the National Bureau of Standards* 60 (1958): 287-296.

and Charles L. Critchfield, using essentially the same equipment as in the earlier work.<sup>123</sup> Their work agreed with Driscoll's Pellat balance work to within an uncertainty of  $3 \mu\text{A}/\text{A}$ . The system of electrical units was stable.

But no matter how beautiful and precise, all this work was applied research, not the basic research the committee felt should be done. The committee had recommended several areas of what could be called materials science for expansion of the division's basic research activities. One of these was dielectrics, and in 1955 the division hired John D. Hoffman to begin a program in this field. The effort developed into the formation in 1956 of the Dielectrics Section in the Electricity and Electronics Division, with a truly basic program in the dielectric properties of polymers. Thus, in at least one area, the division was following the recommendations of the Kelly Committee. But the situation was not to be long-lasting. The section was in due course moved into the Polymers Division, the offspring of the Organic and Fibrous Materials Division.

### Project Tinkertoy

When the divestiture of the weapons work took place in 1953 in the aftermath of the AD-X2 incident, one division working almost entirely on military funds was not transferred out of the Bureau. This was the Electronics Division that was combined with the Electricity Division to create the Electricity and Electronics Division. For some years it largely continued the work it was doing before the divestiture, and perhaps no project is as illustrative of the difference in character between work on the Bureau's basic measurement mission and the military work as Project Tinkertoy.

Concerned about the industrial mobilization and preparedness of the electronics industry in case of a national emergency, the navy's Bureau of Aeronautics realized that the only way to satisfy the anticipated large demand for electronic equipment in such an emergency was a mechanized production system. The system should be flexible so that many different types of electronic equipment could be manufactured with minor changes. Such flexibility could be assured by a modular system, where the modules were structurally the same but could be made with differing electronic functions. The Bureau looked upon the effort as a partial standardization of the electronics industry that would "not only simplify the mobilization of the electronics industry . . . but also would minimize variations in electronic circuit designs," thereby reducing costs for design, maintenance, parts procurement and stocking, and training.<sup>124</sup>

Knowing that as a result of its work on the proximity fuze the Bureau had a wealth of experience with modular design of electronics, and had done pioneering work on printed circuits, and developed such things as tape resistors, in 1950 the navy came to the conclusion that "the most advanced state of processed circuitry is available at the National Bureau of Standards."<sup>125</sup> It therefore asked the Bureau to undertake a project

---

<sup>123</sup> R. L. Driscoll and R. D. Cutkosky, "Measurement of Current With the National Bureau of Standards Current Balance," *Journal of Research of the National Bureau of Standards* 60 (1958): 297-305.

<sup>124</sup> Annual Report, 1953-54: 78.

<sup>125</sup> "Project Tinkertoy: Modular Design of Electronics and Mechanized Production of Electronics," *Technical News Bulletin* 37 (1953): 169.



Robert L. Henry, Project Tinkertoy leader, adjusted a stencil screen mounting on the MPE wafer pattern printer.

to develop the automated production of electronics. Code-named Project Tinkertoy, the major objective of the program was the design and construction of a pilot plant compatible with the principles of modular design and mechanized production of electronics, or MDE and MPE. In short, the Bureau was entering into the development of a process for automated manufacture of electronic equipment and for demonstrating it on a pilot production line. The process was to start with the raw materials to preclude the requirement of manufactured parts (except for vacuum tubes).

The concept was relatively simple. Each stage (e.g., amplifier, oscillator, detector) in an electronic circuit was thought of as a module. Each module was composed of four to six ceramic wafers which carried the components of the stage, such as resistors, capacitors, or coils, each with leads applied by printed-circuit techniques. The ceramic wafers were keyed so that they could fit one above the other in only one way, and were provided with notched edges so that connections could be made from one wafer to another. When assembled, the wafers resembled the floors of a building with the equipment on each floor connected to that on the floors above and below. At the very top—on the roof of the building, so to speak—sat the vacuum tube if one was required





The Project Tinkertoy module. Each module was composed of four to six wafers bearing printed conducting circuits, tape resistors, capacitors, tube sockets, and other miniaturized electronic component parts.

for that stage. These stages, or modules, were then connected to other modules to make the whole electronic circuit. This was called modular design of electronics.

The modules were produced automatically by machines on a production line, the process being called mechanized production of electronics. The wafers were produced

from the powdered ingredients for the ceramic; capacitors, 1/2 in squares, were thin sheets with metallized surfaces produced from various titanate compositions to obtain capacitances from 7.0 pF to 0.01  $\mu$ F; resistors were produced from carbon tapes, previously developed by the Bureau,<sup>126</sup> to obtain resistances from 10  $\Omega$  to 10 M $\Omega$ , with relative uncertainties of 10 percent. Wiring was printed onto wafers, connections made in the standard way, and the wafers connected by copper wires. All the assembly operations were carried out on a single production line by automatic machines, with automatic physical and electrical inspection.

The Bureau did not work alone in this endeavor. The major part of the production equipment design was done by the Electronics Division of the Willys Motor Co., which also operated the pilot production line. Several other commercial organizations helped, particularly in the manufacture of the specialized production machinery.<sup>127</sup>

By 1953 the pilot plant was in operation, and in the fall, while the production line was producing an item of naval equipment, a public announcement of the project was made, stirring considerable industrial interest. An estimate of the manufacturing cost was made and found to be 44 percent lower than conventional processes.<sup>128</sup> By 1955 the main elements of the program had been accomplished, and the pilot plant was being used for indoctrination and training of industrial organizations.<sup>129</sup> Finally, the pilot plant was closed down. The 1956 Annual Report announced, "Since these [MDE and MPE] concepts were first announced in 1953, the art has been further developed and full technical information has been released to private industry. A number of manufacturers . . . have shown extensive interest. . . . This broadened industrial activity and the further improvements now underway in industry makes it appropriate for the Bureau to end its pilot-plant activities."<sup>130</sup> While the Bureau's modular design was not used directly in industry, the modular design and mechanized production concepts have become the customary way of producing electronic equipment.

## HEAT AND POWER

In the opinion of the Kelly Committee, the Heat and Power Division, under the leadership of Ferdinand G. Brickwedde, had a good balance between fundamental research and "developmental research."<sup>131</sup> It was a large division with a staff of 204 (125 professionals), with 86 percent of its support coming from transferred funds. Despite this imbalance of support, the committee's praise of the division showed that in some cases good research could be done with transferred funds.

Foremost among the division's activities was the maintenance and improvement of the International Practical Temperature Scale (IPTS), which necessitated the attainment

---

<sup>126</sup> "NBS Precured Tape Resistor," *Technical News Bulletin* 36 (July 1952): 110-111.

<sup>127</sup> "Project Tinkertoy," *Technical News Bulletin* 37 (1953): 170.

<sup>128</sup> *Manufacturing Cost Determination*, Vol. 5 (New York: Mead, Carney): 31.

<sup>129</sup> Annual Report, 1955: 18.

<sup>130</sup> Annual Report, 1956: 16-17.

<sup>131</sup> Kelly Committee Report: 34.

of very low and very high temperatures, and the exploration of phenomena such as the isotope effect in superconductivity under extreme conditions. The measurements at high temperatures were further motivated by the temperatures achieved in the jet engine industry, and temperature measurements and combustion studies in the jet-engine environment were carried out continuously during the period. Some examples of the research on the temperature scale were the development of platinum vs. platinum-iridium alloy thermocouples for use at high temperatures, a new apparatus for measuring the liquid sulfur fixed point (444.6 °C), a program on gas thermometry to temperatures of 800 °C to bring closer correspondence between the International Practical Temperature Scale and the Thermodynamic Scale, the extension of the range of the platinum resistance thermometer as the definer of the IPTS to the gold point (1063 °C), and the development of a photoelectric pyrometer in 1957.

But the division's work did not stop with research on temperature measurements and on the temperature scale. It carried out a large program on the measurement of thermal properties of matter, often leading to data compendia on various materials, and it had an outstanding capability in the measurement of specific heat of solids, liquids, and gases. Some examples of the work are:

- Standard samples—n-heptane, benzoic acid, and aluminum oxide—certified for specific heat and covering the temperature range from 14 K to 1173 K were issued.
- Motivated by the need for good heat-transfer materials for use in nuclear reactors at high temperatures, the specific heats of sodium and potassium and their alloys were determined up to 1173 K.
- A number of data compendia on the thermodynamic properties of various materials for specific purposes were published: the specific heat of CO<sub>2</sub>, from -50 °C to 100 °C and pressures from 0.5 atm to 1.5 atm, to check the values obtained by calculation and published by the National Advisory Committee for Aeronautics; extensive tables of properties of hydrogen and deuterium for the AEC; thermodynamic properties of wind-tunnel gases—particularly air—up to 3000 K; and extensive tables on the properties of fluorine compounds, particularly those used as refrigerants. The data were obtained both by direct experiment and by theoretical analysis. Some of these data extended to 5000 K.
- The heat capacity of natural rubber and other high polymers was determined over a wide temperature range, as were the heats of solution, density, and vapor pressure of polystyrene and polybutadiene in various solvents.

In addition to this work, the rheology of various polymers was investigated. This research in rheology began with the establishment of the automotive laboratory in 1917 and the consequent interest in lubrication. The division calibrated viscometers and distributed several samples of oils certified for viscosity. The interest in the rheology of high polymers seems to have been brought about by Robert S. Marvin, who was trained in the viscoelasticity of polymers and was hired by the division in 1949. In 1957 a Rheology Section was formed with Marvin as its head. In the same year,



Richard Lee of the Heat Division calibrated a photoelectric pyrometer using a tungsten filament strip lamp. The tool, designed to measure the temperature of a jet engine, replaced the less accurate optical pyrometer.

feeling that with the standard samples available from the Bureau “[m]ore reliable calibration of these instruments is now obtained under conditions of actual use,” the calibration of viscometers was discontinued.<sup>132</sup>

In a somewhat unrelated area, the division had research programs in various aspects of automobile and jet engines. Begun in World War I, an engine laboratory assisted “the then-infant automobile and aircraft industries.” Along with the area of lubrication, hence viscosity, this had led the division into the area of engine fuels, as befits what was essentially a division based on thermodynamics. One of the most important industrial measurements it developed was the octane-number rating of gasoline engine fuels, and it distributed *iso*-octane and *n*-heptane, the two hydrocarbons necessary to determine octane numbers. Throughout 1950-1957, research continued on various aspects of engine knock, combustion in jet engines, and the mechanisms of flame propagation.

<sup>132</sup> Annual Report, 1957: 100.

Then, in 1956, the engine laboratory was discontinued.<sup>133</sup> The Annual Report notes, "The decision was based on careful consideration of the small amount of work of this kind now required by other Government agencies, the nature of the work in relation to other Bureau activities, and the critical need for the space involved by other projects of greater importance. . . . With the tremendous growth of these [the automobile and aircraft] industries they now support their own research, testing and development programs." The decision did not, however, "change the Bureau's activities in regard to maintenance of the standards for measurement of octane number, improvement of methods of measurement, and other standardization work involving fuels and lubricants." It is not difficult to surmise that this decision was part of the policy in the Kelly Committee Report that the Bureau divest itself of activities that were not closely related to its measurement mission, where its activities were essential. That same year, the words "and Power" were dropped from the division's name, and it became simply the Heat Division.

With support from the army's Office of Ordnance Research, a new program was initiated in 1957 that was to have important consequences for the division and the Bureau. In the words of the Annual Report, "[v]aluable information on the structure and properties of matter may eventually result from a three-year program of basic research initiated during the year. The object of the program is to increase fundamental knowledge of the formation, properties, and storage of the highly reactive molecular fragments known as free radicals."<sup>134</sup> Attesting to the significance Bureau management saw in this program, a new section—Free Radicals Research—was formed for this program, and Herbert P. Broida, who had worked with John R. Pellam in the study of nitrogen atoms in rare-gas matrices at liquid helium temperatures, was appointed as its chief. The Free Radicals Program, as it came to be called, was catalytic in the reorganization of all the Bureau's chemistry activities.

Among the division's various programs, the best known in the scientific world was its program in low-temperature physics. The Bureau had been involved in cryogenic research since 1904 when it obtained a hydrogen liquefier, but it was not until 1948, when it obtained a helium liquefier, that low-temperature physics research began in earnest. Built up by Brickwedde and supported by Condon, the low-temperature physics laboratory became one of the best in the world. It attracted a number of outstanding scientists. First was Emanuel Maxwell with his work on the isotope effect in superconductivity. He was followed by John R. Pellam, who did pioneering work in the determination of the speed of second sound in helium.<sup>135</sup> He in turn was followed by two outstanding young scientists from Oxford University, Ralph P. Hudson and Ernest Ambler, both students of Nicholas Kurti. Hudson in due course became chief of the division, and Ambler became the Bureau's eighth director in 1978. This cryogenics capability was the reason for the AEC's choice of the Bureau to build up their cryogenic engineering program.

<sup>133</sup> Annual Report, 1956: 132-133.

<sup>134</sup> Annual Report, 1957: 6.

<sup>135</sup> Below the temperature at which liquid helium first exhibits superfluid properties, heat is conducted in it by a wave motion similar to that by which sound is conducted. This manner of heat conduction is called second sound.

One of the objectives of the low-temperature program was the attainment of extremely low temperatures and devising means of measuring temperatures in this region. In the early fifties very low temperatures—down to about 0.001 K—were customarily attained by the technique of adiabatic demagnetization, and the temperature of the experiment was measured by the same technique.<sup>136</sup> In this technique, a sample of a paramagnetic salt is cooled to as low a temperature as possible by using liquid helium which is being pumped continuously by a vacuum pump. A strong magnetic field, provided by a large magnet, is then turned on. This field aligns all the atomic “magnetic moments.” The sample is then isolated from the liquid helium bath, usually by evacuating the container in which it resides. Since heat can no longer flow in or out of the sample, it is now in an adiabatic (isentropic) container. Now the magnetic field is turned off. Since the sample is thermally isolated, any change in the spin system must occur at constant entropy (isentropic process). But with the external magnetic field gone, the only way for nature to keep the entropy the same is for the temperature to fall. At still lower temperatures, it is possible to align the nuclear spins or, with coupling between the nuclear and electronic spins, even at not too low temperatures (1 K to 0.01 K).

In the early fifties, adiabatic demagnetization was a “hot” scientific area. Brickwedde hired first Hudson and then Ambler to work in the area, and by 1956, the Bureau was recognized as one of the foremost laboratories in the world for research at “very low temperatures.” Now fate was to conspire to bring about one of the most famous—if not *the* most famous—experiments in the Bureau’s history: the experimental demonstration of the nonconservation of parity in “weak interactions.”

### The Parity Experiment

In the October 1, 1956, issue of the *Physical Review*, there appeared a paper by Tsung Dao Lee of Columbia University and Chen Ning Yang of the Institute for Advanced Study at Princeton, but temporarily at Brookhaven National Laboratory.<sup>137</sup> The paper was entitled “Question of Parity Conservation in Weak Interactions,” which was to revolutionize thinking in theoretical physics as well as winning the 1957 Nobel Prize for its authors.<sup>138</sup> In a brilliant theoretical analysis, Lee and Yang came to the conclusion that, contrary to long-held belief, there was no evidence that parity was conserved or not conserved in weak interactions. They proposed two experiments to find the actual situation.

<sup>136</sup> E. Ambler and R. P. Hudson, “Absolute Temperatures Below 1 °K: Chromic Methylammonium Alum as a Thermometric Substance,” *Journal of Chemical Physics* 27 (1957): 378-389.

<sup>137</sup> T. D. Lee and C. N. Yang, “Question of Parity Conservation in Weak Interactions,” *Physical Review* 104 (1956): 254-258.

<sup>138</sup> Parity is a quantum mechanical concept which basically states that the behavior of quantum mechanical systems should not change when viewed in a mirror or, to put it more technically, “are invariant under space inversion.” *Weak* interactions include beta decay, i.e., radioactive decay by the emission of an electron. These interactions are one of the four basic interactions known to physics, the other three being the *strong* interaction, which holds the nucleus together; the *electromagnetic*, which is responsible for the force between charged particles and holds the atom together; and *gravitation*, which governs the behavior of bodies with mass.

One experiment involved the measurement of any angular asymmetry of the electron emission from polarized cobalt-60 nuclei, such as cobalt-60 nuclei oriented so that the spins of all of them point in the same direction. Any asymmetry in the electron emission with respect to the forward and backward directions of the nuclear spin would immediately indicate that parity is not conserved and that, in beta decay, nature prefers one hand over the other.<sup>139</sup> In principle, this is an easy experiment, but in practice it is very hard. First, and most important, a sample of cobalt-60 with oriented nuclear spins must be available, and this means very low temperatures. Second, one must be able to get the very low-penetrating beta particles out of the sample used to orient the nuclear spins, and out of the cryostat used to cool them. Alternatively, a beta-particle detector would have to be developed for use in the cryostat.

Now, the Cryogenic Physics Section of the Bureau, whose chief in 1956 was Hudson and in which Ambler was a principal scientist, knew how to orient radioactive nuclei. Both earned their doctorates in the Clarendon Laboratory at Oxford University where, under the leadership of Sir Francis E. Simon and Nicholas Kurti, there was a major research program in the physics of very low temperatures produced by magnetic cooling, coupled with the work of Brebis Bleaney, Maurice H. L. Pryce, and later with others on the techniques of nuclear orientation. Ambler and Hudson brought these techniques to the Bureau and, working with Georges M. Temmer of the Carnegie Institution, had published two papers on nuclear alignment in cerium-141, cerium-139, and neodymium-147, all radioactive nuclei.<sup>140</sup> Moreover, while still a graduate student at Oxford, Ambler, working with six others, had polarized cobalt-60 nuclei, and measured the anisotropic emission of the gamma radiation. But there had been no good reason at that time to tackle the experimentally difficult task of measuring the asymmetry of the beta radiation as was now being suggested by Lee and Yang.<sup>141</sup>

The Lee-Yang work was not immediately known to Ambler and Hudson, but their own work and capabilities were generally known to most of the physics community. Consequently, on June 4, 1956, before the publication of the Lee-Yang paper, Ambler received a telephone call from Professor Chien-Shiung Wu, a colleague of Lee at Columbia University and herself an expert in beta decay. Ambler recalls, "I didn't know who she was, although I'd heard of the name. She said that Lee and Yang had had this idea that with beta particles from cobalt-60, more will come up in one direction of

---

<sup>139</sup> This follows directly from the fact that the spin direction (an axial vector) is not changed by a parity operation, while velocity (a polar vector) is inverted.

<sup>140</sup> E. Ambler, R. P. Hudson, and G. M. Temmer, "Alignment of Cerium-141 and Neodymium-147 Nuclei," *Physical Review* 97 (1955): 1212-1221.

—"Alignment of Three Odd-A Rare-Earth Nuclei," *Physical Review* 101 (1956): 196-200.

<sup>141</sup> E. Ambler, M. A. Grace, H. Halban, N. Kurti, H. Durand, C. E. Johnson, and H. R. Lemmer, "Nuclear Polarization of Cobalt 60," *Philosophical Magazine* 44 (1953): 216-218. The possibility of observing the beta emission had been discussed often at Oxford, but it was not done for two reasons. First, because of the limited range of the beta radiation (compared to the gamma, which had been observed), the electrons could only get out of the surface layers of the paramagnetic salt used for cooling, and second, could not pass out of the cryostat. Most important, of course, before the Lee and Yang paper, accepted theory predicted no unusual effects, so that the scientific spur to do the difficult experiment was lacking.

the field than the other. I said, 'Are you sure you mean up and down?' She said, 'Yes, up and down, that's the difference.' I said, 'Is there a preprint of that paper?' She said, 'Yes.' I said, 'Send me one.' So she sent me one. The first thing I did was to check with our radioactivity people and discovered that she was tops in her field, so it was a request to be taken very seriously."

Having the request from Wu to carry out the Lee-Yang experiment, and knowing that it was a very serious request, Ambler checked with "some of the senior physicists at the Bureau, and they all shook their heads and said, 'It's a very, very, very long shot.' Ralph [Hudson] and I talked about it and we sort of decided, and I became convinced, that it was one of those things that is a risk you've absolutely got to take, because it was clear that the whole thing would be absolutely revolutionary. So I went to see Brick [Ferdinand Brickwedde] and explained it and told him that I thought we could do it with the budget we had. Damn if old Brick said, 'Well, Ernie, if it's not going to cost any more money, you go right ahead and do it.' I called her and said, 'Sure.'"<sup>142</sup>

After several weeks of preparatory work, two nuclear physicists, Raymond W. Hayward and Dale D. Hoppes—the experts on beta radiation from the Bureau's Atomic and Radiation Physics Division—were asked to join the effort. Prof. Wu had been coming down from Columbia periodically with two graduate students, but it had become clear that beta radiation experts were needed on the spot. The objective of the experiment was the measurement of the forward-backward asymmetry of the electron emission from the polarized cobalt-60 sample.<sup>143</sup> Because the range of the beta rays is very short, the radioactivity had to be confined to the very surface layers of the paramagnetic salt used for cooling. And a serious concern was whether the surface layers would stay cold long enough to do the experiment. There clearly was only one place to do the counting of the emitted electrons, namely inside the experimental chamber just above the sample of cobalt-60. With this limitation, there was only one way to determine if there was any asymmetry of the electron emission with respect to the direction of the nuclear spin. First, the spins are oriented in one direction, say "up," and the electron counting rate determined. Then the spins are oriented in the opposite direction, say "down," and the counting rate determined again. If the counting rates are different in the two cases, the electrons are emitted preferentially along (or against) the spin direction, hence the emission is asymmetric with respect to the direction of the nuclear spin and parity is not conserved.

In more detail, to do the counting a small thin disk of anthracene was placed just above the sample and a Lucite light pipe carried the scintillations to a phototube outside the cryostat. The sample itself was a single crystal of cerium magnesium nitrate with a thin layer containing the cobalt-60 grown on its upper surface. Equatorial and polar sodium iodide photomultiplier counters placed well outside the cryostat monitored the gamma emission, hence the nuclear polarization of the sample.

<sup>142</sup> Interview with Ernest Ambler, July 7, 1988: 4-5. NIST Oral History File.

<sup>143</sup> C. S. Wu, E. Ambler, R. W. Hayward, D. D. Hoppes, and R. P. Hudson, "Experimental Test of Parity Conservation in Beta Decay," *Physical Review* 105 (1957): 1413-1415.





NBS scientists assembled low-temperature equipment used in the experiment which disproved the principle of conservation of parity in nuclear physics. Left to right: Ralph P. Hudson, Ernest Ambler, Dale D. Hoppes, and Raymond W. Hayward.

Many operational difficulties had to be overcome as the work progressed and, in fact, at one point an entirely redesigned cryostat was constructed. Conclusive results were first obtained in late December 1956, some six months after Prof. Wu's first telephone contact.

The experiment was carried out as follows: First the sample was cooled by adiabatic demagnetization using a large electromagnet. Then the latter was removed and a small solenoid magnet placed around the cryostat. Because of the interaction of the nuclear spins with the very strong field caused by the electron spins, a relatively small current

PARITY NOT CONSERVED!

90 Dec 27, 1956. 28

Tie capitals in bundle: -  
No formulas.

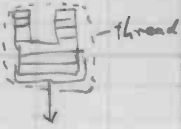

Density I 100a  
11<sup>h</sup> 01' Magnet On. P.ami 6.3 → 8.3 p.  
25' Pump.  
48' Density

Pumped down with wooden block  
on timing solenoid.

Density II 100a.  
12<sup>h</sup> 04' Magnet On. 12.0 → 14.5 p.  
22' Pump.  
42' Density Filed on ←

12-49<sup>h</sup> 50'  $\int_{10}^{14} \frac{1}{H} dH$   
12-50' 4.85 (10<sup>2</sup>) (5)

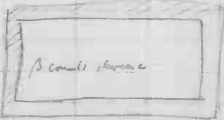

Density III 100a  
12.55 (10.2 - 12.5a)  
13.05 Pump. 13.21 Pump. 10.05' Pump. solid → 6 ←  
11.0 11.90<sup>40</sup>  
12.55' H off.

1.24 11.52 (1r) 1/10  
3.448 ~ 11.60  
4.157  $\int_{10}^{14}$   
30 11.90  
6.30  
9.60 11.90.

→ 13.64 amp H

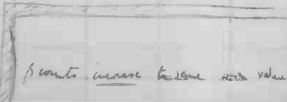

This page from Ernest Ambler's notebook recorded the first successful demonstration that parity is not conserved in the emission of beta particles by cobalt-60. At the top of the page, Ralph P. Hudson lettered PARITY NOT CONSERVED! (courtesy of the National Museum of American History)

passing through the solenoid oriented the electron spins and through them the nuclear spins along the magnetic field in the solenoid, either up or down depending on the direction of the current through the solenoid. Due to small but inevitable heat leaks, the sample continued to warm, and in about eight minutes warmed up to such a temperature that the nuclei were no longer oriented. During this time the electron counting rate dropped for one orientation of the field as the orientation in the sample decreased as monitored by the gamma emission. The counting rate reached a constant value when the sample was sufficiently warm that no orientation existed. Now the experiment was

repeated for the opposite direction of current in the polarizing solenoid. The behavior of the electron counting rate with time was now the opposite of what it had been with the field in the other direction. If it previously decreased with time, it now increased, and vice versa, eventually reaching the same warm-temperature value. This experimental result proved conclusively that the emission of the electrons is preferentially along the spin, and further analysis shows that it is preferentially in the direction opposite to the spin. Hence there is an asymmetry of the electron emission with respect to the direction of orientation of the nucleus, and parity is not conserved in the weak interaction.<sup>144</sup>

The demonstration of the nonconservation of parity in the weak interaction stunned the theoretical physics community, which immediately became concerned with the violation of other symmetry principles. The situation became more complex. Of particular interest were the symmetries of charge conjugation, (C-inversion of charge, or changing from particle to antiparticle), and time reversal (T). Work by Lee, Yang, and Reinhard Oehme published after the original cobalt-60 paper—but known to the Bureau group via communication with Yang—showed, as was already suggested in the original paper, that not only was parity not conserved in weak interactions, but charge-conjugation invariance was also not obeyed, although under certain conditions the combination of the two was. It then became very important to see if invariance under time reversal was also violated, for a very fundamental theorem due to Wolfgang Pauli and Gerhart Lüders states that the triple operation of charge conjugation (C), space inversion (P) and time reversal (T), or CPT, will always be conserved. Hence the Bureau group continued to work in the area, carrying out essentially the same experiments with cobalt-58 (a positron emitter and hence important because of charge conjugation), and later on manganese-52 specifically to see if time-reversal invariance could be proved. Within the limits permitted by the data, T was conserved.<sup>145</sup> Further work continued on yet other nuclei to obtain data on the parameters in the theory and the work became more and more nuclear physics.<sup>146</sup> In 1969 the final Bureau work on the conservation laws was carried out by Russell C. Casella, theoretician member of the Radiation Theory Section. By an analysis of experimental data on the decay of the neutral K mesons, for which it was known that CP invariance is violated, Casella showed that the CP violation is connected with a violation

---

<sup>144</sup> R. L. Garwin, L. M. Lederman, and M. Weinrich, "Observations of the Failure of Conservation of Parity and Charge Conjugation in Meson Decays: the Magnetic Moment of the Free Muon," *Physical Review* 105 (1957): 1415-1417. In a paper published at the same time as the Bureau's parity paper, Richard L. Garwin, Leon M. Lederman, and Marcel Weinrich of Columbia University showed that parity is also not conserved in meson decays.

<sup>145</sup> E. Ambler, R. W. Hayward, D. D. Hoppes, R. P. Hudson and C. S. Wu, "Further Experiments on  $\beta$  Decay of Polarized Nuclei," *Physical Review* 106 (1957): 1361-1363; E. Ambler, R. W. Hayward, D. D. Hoppes and R. P. Hudson, "Beta-Gamma Correlations from Polarized Manganese-52," *Physical Review* 110 (1958): 787-789.

<sup>146</sup> D. D. Hoppes, E. Ambler, R. W. Hayward, and R. S. Kaeser, "Matrix Elements in the Forbidden Beta Decay of  $\text{Ce}^{141}$ ," *Physical Review Letters* 6 (1961): 115-118; D. D. Hoppes, "The Angular Distribution of Beta Particles from Oriented Cerium-141 Nuclei," *Proceedings of the 7th International Conference on Low Temperature Physics* (University of Toronto Press, 1961): 186-188.

of time-reversal invariance, but that there was no evidence of CPT violation.<sup>147</sup> “In Nature, past and future are thus distinguishable even on a *microscopic* level.”<sup>148</sup>

In retrospect it is difficult to find a better example of what the Kelly Committee had in mind when it insisted that the Bureau get back to doing research in its unique mission. A group formed to work on the production, measurement, and application of low temperatures, and given some latitude to follow their own interests were, admittedly by a happy combination of circumstances, brought face to face with some of the most fundamental questions in all of physics. And they were able to answer at least one of them.

### ATOMIC AND RADIATION PHYSICS

Formed in 1947 as part of his reorganization, the Atomic Physics Division was Condon's principal mechanism for bringing the new physics to the Bureau. It was started with five sections of the Optics Division—Spectroscopy, Atomic Physics, Radiometry, Radioactivity, and X-Rays—and it was as if Condon had grouped together those aspects of the Bureau's work that rested on quantum mechanics as a foundation. The division grew rapidly with the addition of new, bright, young scientists—one of whom, Lewis Branscomb, was to become a Bureau director—so that by the time the Kelly Committee investigated the Atomic and Radiation Physics Division in 1953, it had a total staff of 176 employees, 120 of whom were professionals. Led by Lauriston S. Taylor, it was organized into two laboratories: the Atomic Physics Laboratory with eight sections, and the Radiation Physics Laboratory with seven sections. With 46 percent of its funds coming from direct appropriations, it was relatively well supported by Bureau funds.

In some ways the division's name was a misnomer, for its work included electron physics, solid state physics, radiometry, and instrumentation. It was one of the Bureau's stellar divisions, winning high praise from the Kelly Committee, which found its work excellent, and whose only lament was that there was not enough of it.<sup>149</sup> Three of the division's notable accomplishments and areas of work have already been described: length and light, standards and fundamental constants, and x rays. Here we give a rather cursory account of some of the other activities of the division.

Considering its history, it is not surprising that one of the strong elements in the division's program was spectroscopy. While the work on the development of the green line of mercury-198 into a standard of length was perhaps the most famous development in the division's work during the fifties, there was other meritorious work of

---

<sup>147</sup> R. C. Casella, “Time Reversal and the  $K^0$  Meson Decays,” *Physical Review Letters* 21 (1968): 1128-1131; and “Time Reversal and the  $K^0$  Meson Decays II,” *Physical Review Letters* 22 (1969): 554. The author is deeply indebted to Dr. Casella for several discussions on the conservation of these various symmetry operations.

<sup>148</sup> Otto Nachtman, *Elementary Particle Physics: Concepts and Phenomena* (Berlin: Springer-Verlag, 1990), Chapter 26: 1.

<sup>149</sup> Kelly Committee Report: 36-38.

perhaps even greater utility to the practicing spectroscopist. Three volumes of atomic energy levels were published. Volume I, published in 1950, was for elements up to atomic number 23. Volume II, in 1951, covered elements 24 through 41, and finally Volume III, in 1956, covered elements 42 through 57 and 72 through 89. In a similar vein of providing reference data for science and technology, the division published tables of complex spectra listing over 6700 radiations from singly and doubly ionized chromium. A similar publication gave the intensity of spectral lines for 70 elements to be used for identification purposes. Other publications gave a series of wavelengths to be used as standards of wavelength in the infrared, as well as the hyperfine structure of technetium. In a sense, the publication of these data collections was complementary to the publication of *Nuclear Data* as Circular 499 in 1950, with a supplement in 1951. Containing data on half-lives, radiation energies, relative isotopic abundance, nuclear moments, cross sections, and nuclear decay schemes, these tables became the bible of the nuclear physicist. Finally, in an unusual effort for spectroscopy, the division made one of two accurate determinations of the speed of light. The other came from a more expected quarter, the Central Radio Propagation Laboratory.

Spurred by the wartime development of crystal diodes and the recent invention of the transistor, the division in 1949 began a program in the study of semiconductors. But germanium and silicon, the materials that were to become the economic standbys, were never studied in the fifties. Rather, the program was concerned with the more general questions of the transition from electron to hole conductivity, the measurement of mobility, and the effect of lattice defects. The first materials studied were rutile (titanium dioxide,  $\text{TiO}_2$ ) with some of the oxygen removed, and grey tin, for which there were great problems in the preparation of macroscopic single crystals. Experiments concentrated on photoconductivity and rectification, the latter being achieved with  $\text{TiO}_2$ . Of note was an attempt to study the crystal imperfections in  $\text{TiO}_2$  by the study of internal friction, a direction which was to have important scientific consequences later in the Mineral Products Division. Toward the end of the period the work shifted to become closer to commercial practice with the study of intermetallics. These were compounds of antimony or arsenic with indium, gallium, or aluminum—the so-called “three-five” compounds, from the numbers of the columns of the components in the periodic table. In 1957, the material worked on was indium antimonide.

Because of widespread interest in very high-energy x rays, the Bureau by 1952 had purchased and installed a betatron (50 MeV) and a synchrotron (180 MeV). With these two major instruments the Bureau both continued and expanded its work in x-ray protection and was led into nuclear physics. Thus, throughout the fifties, work continued in radiation protection and monitoring. The design and construction of what are now the ubiquitous radiation-monitoring film badges were worked on, as were means of shielding against x rays. The efficacy of concrete barriers was a constant concern, and much experimental and theoretical work was carried out. A sentence in the Annual Report for 1952 gives the aim of this work: “Ultimately, the accumulated data will form a basis from which radiation barriers of the correct thickness and material may be designed for economical and safe protection.” As part of the effort, the Bureau published Circular 583, *X-Ray Attenuation Coefficients from 10 Kev to 100 Mev*, which

gives attenuation coefficients for twenty-three materials, including air, water, and concrete. Finally, in 1954, Handbook 50, *X-Ray Protection Design*, was published.<sup>150</sup>

All this work on x-ray shielding inevitably led to questions of the scattering of x rays by atomic nuclei, and the Bureau, with its betatron and synchrotron, was well placed to carry out such studies. Thus, with the hiring of a group of bright, young scientists, the Bureau became a world-renowned center for photonuclear research, with a great deal of the work supported by the Atomic Energy Commission (AEC). In this work, the first observation of a resonance in the elastic nuclear scattering of photons was made, leading to information about the nuclear energy level structure. In a similar vein, as part of a study to provide data for nuclear-structure theorists, the angular distribution of the monoenergetic gamma rays emitted from the carbon nucleus when irradiated with high-energy x rays was determined. In 1957, the study of  $\pi^0$  mesons from carbon led to information on the distribution of nuclear matter in the nucleus, and a correlation was shown between the photoneutron yield from a given nucleus and the deformation of the nuclear surface, thereby opening a new approach to the study of nuclear quadrupole moments. By the end of the fifties, the Bureau was solidly involved in nuclear physics research.

Along with this x-ray work there was a related effort in the standardization of measurements in radioactivity, both to determine the correct activity level and for safety reasons. The rise of nuclear reactors made available a number of artificially produced radioactive isotopes, and these were becoming more widely used in medicine, science and industry. Thus, in 1950, the Bureau issued standard samples for the standardization of the measurement of activity of such samples. To check the accuracy of radiation meters, the Bureau constructed a portable cobalt-60 source. In the laboratory several calorimeters were built to measure the intensity of low-level radioactive sources on the one hand, and of high-voltage x-ray sources on the other. And the radiation measurement system had to be checked against its international counterparts. In 1953 the national primary x-ray standard was transported to the National Physical Laboratory in England and compared with the British national x-ray standard. Two discrepancies found in the British standard caused a redesign of that standard. A later comparison of the U.S. and British standards gave improved results. Similarly, the primary British and Canadian radium standards were transported to the Bureau for comparison. While the British and U.S. standards compared satisfactorily, the Canadian differed by 0.5 percent from its assigned value.

The area of mass spectrometry merits mention because of its subsequent development. Throughout the whole period, the division carried out work in this field, including the development of lightweight, portable mass spectrometers. The Bureau became so well recognized for these measurements that, in 1956, it began a program to issue standard samples for isotopic abundance, an important matter for workers in geology and geochemistry. The samples were to be issued internationally as well as domestically. Eventually this led to the Bureau achieving a unique position in the measurement of isotopic composition, and hence the determination of atomic weights.

---

<sup>150</sup> Other NBS Handbooks on related topics were: No. 52, *Maximum Permissible Amounts of Radioisotopes in the Human Body and Maximum Permissible Concentrations in Air and Water*; No. 53, *Recommendations for the Disposal of Carbon-14 Wastes*; No. 55, *Protection Against Betatron-Synchrotron Radiations Up to 100 Million Electron Volts*; No. 56, *Safe Handling of Cadavers Containing Radioactive Isotopes*.

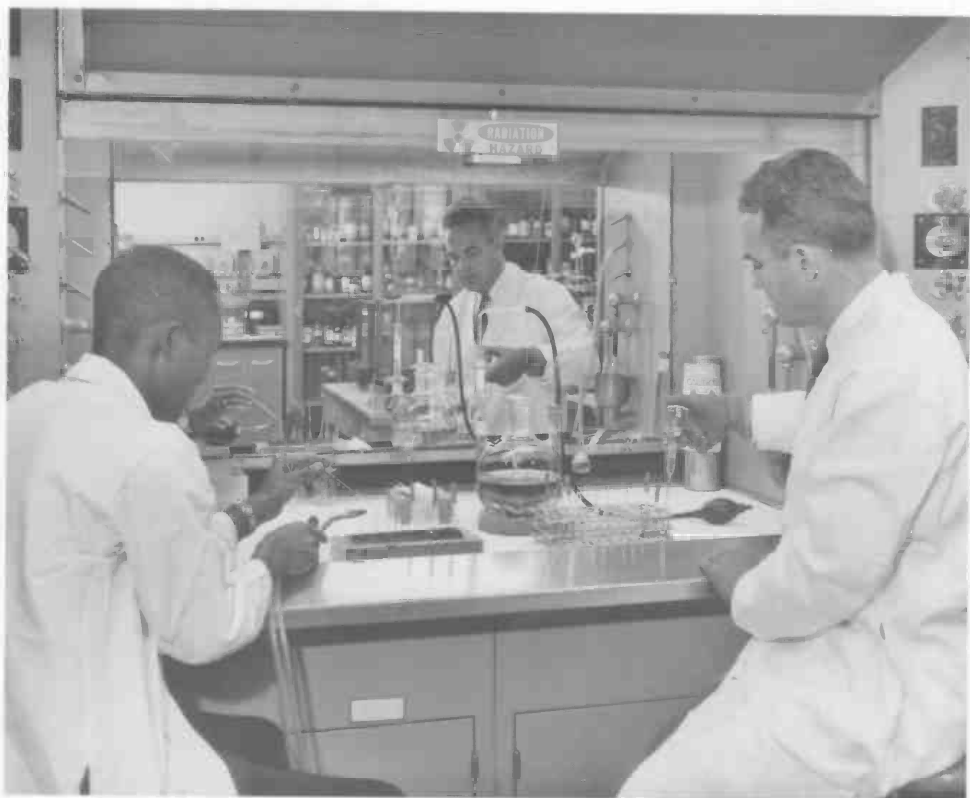

Robert W. Medlock (left) and William F. Marlow of the Radioactivity Section filled and sealed ampoules with the benzoic acid (7C-14) standard sample (in center flask) for liquid-scintillation counters.

The Electron Physics Section was under the direction of Ladislaus L. (Bill) Marton who, among other achievements, was the organizer of the Division of Electron Physics of the American Physical Society—the first division of that society. Marton's avowed aim for the section was to do everything with electrons that had been done with light. Thus, one of the achievements of the section was the construction of an electron-beam interferometer, followed by an electron spectrograph. With the main aim being better understanding of the processes by which electrons lose energy upon impact with atoms, the latter instrument measured the angle of scatter and was capable of detecting a loss of 5 eV from an initial electron energy of 50 keV. Since this instrument was limited to small angles, a variation was developed that could measure scattering angles up to 100°. Automatically measuring every  $\frac{1}{8}^\circ$ , the instrument could give energy loss and intensity over the whole range in one-half hour. First used to study copper, aluminum, beryllium, and gold, the instrument was later modified to study low-pressure gases.



John Simpson adjusted an electron-beam interferometer, a device that utilized electron beams to produce interference fringes in much the same way that conventional optical interferometers used light beams. The instrument employed diffraction from an extremely thin crystal as a means for splitting and recombining an electron beam. Three crystals were mounted in a vacuum chamber (center) placed between the illuminating and viewing systems of a conventional electron microscope. Each of the crystal mounts could be rotated around the optical axis. The mount of the first crystal could also be translated along the optical axis. The controls for these motions were brought out at the bottom of the evacuated chamber.



In another form of data compendium, the section published *Electron Physics Tables* in 1957.<sup>151</sup> Covering the energy from 0.206 eV to 3.353 TeV, and calculated with the help of SEAC, the NBS automatic digital computer, these tables gave the potential difference necessary to accelerate an electron to a specific kinetic energy ( $V$ ), the effective relativistic potential energy ( $V^*$ ), the product of magnetic field and radius of curvature of an electron in a magnetic field ( $H\rho$ ), the deBroglie wavelength ( $\lambda$ ); momentum in units of  $m_0c$  ( $p^*$ ), kinetic energy in units of the rest energy ( $E^*$ ), total energy ( $W^*$ ), and the ratio of speed to the speed of light ( $\beta$ ).

With programs in electron physics, where the avowed aim was to do everything with electrons that could be done with optical instruments, and with the study of negative ions, the Atomic and Radiation Physics Division was a scientifically productive unit.

## CHEMISTRY

Identified as Division III, the Chemistry Division with a staff of two in 1903 was the third one formed at the Bureau. By 1953, under Edward Wichers, it was a large division with a staff of 181 (147 professionals) organized into eleven sections. Since the standards aspect of chemistry is largely concerned with the composition of materials, the division was heavily involved in developing methods of chemical analysis and the analysis of materials for special purposes. It also produced a large number of standard samples, many for the composition of commercial metals and alloys. In a related activity, it was concerned with the preparation of very pure substances and had programs in purification and separation. Its analytical effort was by no means limited to solids and liquids, but extended to the difficult field of gas analysis. It covered the areas of inorganic and organic chemistry, but only in specialized areas of these immense fields. It had important work in areas of surface and colloid chemistry, physical chemistry and, particularly, thermochemistry.

Two areas of work, organic coatings and electrodeposition, were rather specialized and took place at the Bureau for historical reasons. The Bureau became involved in the first of these in 1914 when it took over the function of acceptance testing of paints and varnish—among other commodities—from the contracts laboratory of the no-longer-existent Bureau of Chemistry of the Department of Agriculture.<sup>152</sup> In 1953 that work was carried out under Paul T. Howard in the Organic Coatings Section. Commodity testing was still performed, but by 1955, routine testing had ceased, and the work changed to the more valuable development of test methods and specifications for use by all agencies which purchased paints and other coatings.

The electrodeposition work existed at the Bureau only because of the vigor, stamina and technical inventiveness of William Blum, the section leader until 1954. Called in 1913 to the Bureau of Engraving and Printing on a troubleshooting effort on the

---

<sup>151</sup> L. Marton, C. Marton, and W. G. Hall, *Electron Physics Tables*, Natl. Bur. Stand. (U.S.) Circular 571; March 1956.

<sup>152</sup> Kelly Committee Report: 41; MFP, 155.

BPE's electrotyping baths, he quickly solved the problem. Struck by the lack of methods to control the baths, and the paucity of the literature on the topic, he decided that electrodeposition was a field ripe for scientific exploration. Thus began a fruitful and productive career.<sup>153</sup> Blum was followed by Abner Brenner, an equally ingenious and entrepreneurial scientist. Unhappy with a program that was built on the interest and ingenuity of one man, the Kelly Committee felt that this "level of effort . . . appears out of proportion to the entire program of the Chemistry Division."<sup>154</sup> In 1961, the section was moved into the Metallurgy Division.

The analytical chemistry work of the division was partly devoted to the development of new methods of analysis and partly to the analysis of specific materials—mostly metals. Because of their inherent speed, the various techniques of spectrochemistry were used for as many purposes. Flame photometry was used to analyze calcium in sugar solutions, and spectrographic methods were used for bismuth, tin in bronze, and magnesium in cast iron. The crucial matter of the effect of excitation conditions on the intensity of spectral lines was studied and brought under control. Further spectrographic methods were employed for impurities in nickel used for cathodes in electron tubes, for the analysis of complex dental alloys, for trace elements in portland cement, and for alkalis in refractory materials.

Not performed spectrochemically, but notable because of its use of a rapidly emerging analytical method, was the analysis of cobalt-based alloys for jet-engine turbine blades, the so-called "superalloys." This was done by the isolation of the alloy components—cobalt, nickel, iron and manganese—by chromatographic separation on ion-exchange resin columns. The method was further applied to the separation of niobium, tantalum, titanium, tungsten, and molybdenum as they occur in stainless steels. Further analytical methods based on separation were developed for determining the composition of complex dielectrics—mostly titanates—used for proximity fuzes. Finally, a chromatographic method on a commercially activated carbon was developed for the analysis of corn syrup. When coupled with analyses performed for the issuance of new standard samples—such as for the composition of a jet engine alloy, and the composition of white iron—and for the reissuing of existing ones, it is clear that this was an active and productive research effort.

Closely associated with analytical problems is the production of very pure substances. At the time of its formation, the division was concerned with "a study of the standards of purity for chemical reagents and of the methods to be used for the quantitative determination of small amounts of impurities in such reagents,"<sup>155</sup> and that concern still existed in the fifties, but was not limited solely to reagents.<sup>156</sup> Again, work went ahead on the development of general methods of purification and on the production of specific pure materials, often at the request of another agency. One of

---

<sup>153</sup> MFP, 128.

<sup>154</sup> Kelly Committee Report: 41.

<sup>155</sup> Annual Report, 1906: 14.

<sup>156</sup> MFP, 379. The Bureau's history in the production of pure materials stood the Nation in good stead in the early days of the Manhattan Project when the Bureau devised a method of purifying graphite for the nuclear pile.

the purification methods studied was crystallization. Noting that purification is often achieved by repeated crystallization, its inverse, fractional melting, in which supernatant melt is periodically withdrawn, was developed by division chemists as a means of concentrating impurities, hence making the determination of their amount and their identification easier. In true purification, the by-now-commercial zone refiner was adapted to the purification of low-melting-point solids by constructing a bath of two immiscible liquids, the upper held at a temperature above the melting point of the material to be purified and the lower at a temperature below. The interface between the two liquids provided a sharp temperature gradient, and passage downwards through it of a tube of the material to be purified provided the zone refining. But a more interesting discovery came in 1957. Working with the production of single crystals of ammonium phosphate from aqueous solutions contaminated with chromium, it was found that when growth is normal to some crystal faces the impurity enters the crystal, while for other faces it does not—or at least its entry is much reduced. Thus the control of the crystal growth direction can produce a purer and more perfect crystal. In the preparation of specific pure substances, the chromatographic column again proved its worth. Such methods were used with ion-exchange columns to prepare nearly all of the rare earths with a purity of 99.99 percent. Other purifications by this and other methods led to the preparation of several very pure titanium salts and several titanates.

Gas analysis programs developed some important new methods and, as a harbinger of things to come, broke into a new field. One of the important new methods was the detection of impurities in hydrogen by thermal-conductivity measurements. By this method, one part in 10 million of any other gas could be detected and the apparatus could give direct readings from any of fifty sampling sites. Another important new method was the spectrometric analysis of high-purity gases. A glow discharge in the flowing gas was excited by a high-frequency field and the emitted light was observed by an automatic scanning photoelectric spectrometer. Useful for flowing gas, the apparatus could detect concentrations of one part per million of hydrogen, nitrogen, and water vapor, and was obviously useful for flowing gas streams.

The new area where the division began work was air pollution. In 1950 the Bureau appears to have made its first attempt to work in this field. At that time, the Bureau, working in Los Angeles, concentrated smog components by collecting them on a filter at liquid-oxygen temperatures. They were then separated by isothermal distillation and the fractions analyzed by mass spectrometry. About sixty compounds were positively or tentatively identified. Most seemed to be hydrocarbons or reaction products of hydrocarbons with ozone or nitrogen dioxide. Thus the Bureau entered into the field of air pollution and interaction with other agencies of the Federal, state and local governments. As the Nation became more serious about the control of air pollution, the Bureau's activities in this area increased.

Aside from composition, another area of chemistry where the Bureau provided standards was that of acidity. In that activity it sold standard samples certified for a given pH, or hydrogen-ion concentration. Work throughout the period was designed to improve the accuracy of the standards and to expand their utility. In 1950, for example, four new standards were issued to improve the accuracy at the low and high ends of the pH scale, and in 1953 the top of the useful temperature range of the

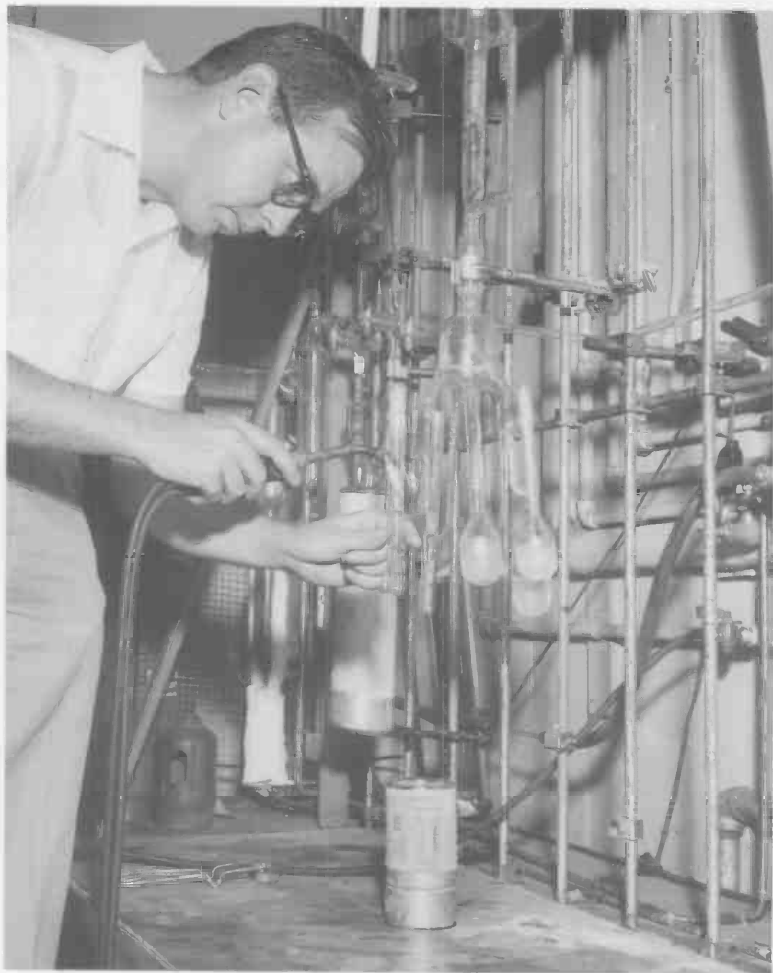

As the final step in purification of a substance by fractional melting, Gaylon S. Ross sealed off an ampoule containing the purified sample (1957).

standards was increased to 95 °C. But perhaps the most interesting development was the concern with acids and bases in nonaqueous solvents—an area of interest to the petroleum, food and drug industries, and to several scientific fields, among them analytical chemistry and electrodeposition. The behavior of acids and bases in nonaqueous solvents was puzzling in that there was no constancy in the order of relative strengths as some nonaqueous solvents were substituted for water. But there began to appear a relationship between the structure of individual acids and their behavior in different kinds of solvents.

The division had a strong program in thermochemistry. Experimental work was carried out on the determination of heats of combustion, of formation, and of other reactions, usually on compounds of particular interest at the time, or on series of compounds, such as different isomers or homologous series of organic compounds,

where basic questions, such as the effect of *cis-trans* isomerism on reaction energies, could be addressed. Thus, for example, measurements of the heats of formation of various boron compounds were carried out to "aid in understanding these relatively new compounds in which the usual laws of chemical bonding do not apply." Similarly, data were obtained on various series of hydrocarbons, examples of which are the heats of formation of *ortho*-, *meta*-, and *para*-*tert*-butyltoluene to obtain information on steric effects, and on all the pentenes and pentadienes, and some hexenes to obtain the effects of alkyl substituents on double bond energies "which are valuable in synthetic-rubber development."<sup>157</sup> But the program went far beyond laboratory measurements. A file was kept on all publications in this field, and in 1952 a massive publication was announced. "In the continuing project on the collection and critical evaluation of the chemical thermodynamic properties of substances . . . a milestone was passed with the publication of a 1200-page circular (C500) entitled *Selected Values of Chemical Thermodynamic Properties*."<sup>158</sup> Containing values of heats and free energies of formation, entropy, heat capacity, and heats and temperatures of transition, fusion, and vaporization for all inorganic compounds—where data were available—and organic compounds of less than three carbons, it was periodically supplemented by looseleaf tables. Circular 500 became the bible of thermochemists and was immensely useful to chemical engineers in process design.

Circular 500 was not the only data issued by the division. Basic data on the infrared spectra of some 15 000 chemical compounds—their fingerprints, so to speak—were prepared with the cooperation and financial support of the National Research Council, and distributed to more than 200 cooperating laboratories in 1955. In the next year, the division published Circular 566, *Bibliography of Solid Adsorbents, 1943 to 1953*, a 1500-page volume containing nearly 14 000 scientific abstracts. These publications, along with the others mentioned in other sections, continued the Bureau's long tradition of publishing such compendia as a service to industry and science. This service was to become a formalized activity of the Bureau in the National Standard Reference Data System.

The Kelly Committee had pointed out that the organic chemistry program of the Chemistry Division was insufficient to keep pace with industrial developments. This was true, although it could be argued that it was impossible for any single organization to keep up with the explosive growth of the postwar chemical industries. There was, however, one area in which the Bureau not only kept up with industry and science but was in fact a world leader. This area was that of carbohydrate chemistry, and specifically the synthesis of sugars with radioactive carbon-14 in a specific location in the molecule. In fact, except for some early work in 1951 on the purification of a large number of hydrocarbons and sulfur compounds obtained from other laboratories and thence sold as standard samples, and some work in 1957 on the relative strength of

---

<sup>157</sup> Annual Report, 1953-1954: 38.

<sup>158</sup> Annual Report, 1952: 26.



After final crystallization, Benjamin Bruckner placed position-labeled radioactive sugars in the bottom of small weighing bottles in amounts of 10 mg to 100 mg, and the exact weight of each sample was determined. The samples were then distributed in the weighing bottles to other laboratories.

aromatic carboxylic acids in benzene, all the Bureau's organic chemistry research was on the synthesis of such sugars.<sup>159</sup> In work sponsored first by the AEC because they were "useful in biology, where scientists are interested in discovering the mechanism by which a molecule becomes either a source of energy or contributes to the structure of living cells,"<sup>160</sup> the Bureau not only synthesized a large number of such labeled

<sup>159</sup> For an account of the Bureau's abortive efforts to create an industry to produce levulose and other rare sugars, see MFP, 265-266.

<sup>160</sup> Annual Report, 1952: 24.

sugars, but also became a supplier of them to laboratories engaged in such work. It clearly had been planned that industrial organizations would manufacture and sell them but, except for two substances, this did not occur. The synthetic methods were simply too complex and expensive. It is clear that the AEC came to the Bureau for this work because of the competence of Horace S. Isbell, its leader, and he in turn was involved in this work because of the Bureau's long history in sugar chemistry, dating from the days of its involvement in determining the sugar content of solutions by polarimetry for customs purposes.<sup>161</sup>

A related area made more important by the outbreak of the Korean War was that of the compound dextran. Formed by the action of the bacterial agent *Leuconostoc mesenteroides* on glucose, dextran was a polysaccharide with utility as a blood extender, and hence a substitute for plasma. Quite a bit of work borrowed from polymer chemistry went into the determination of molecular weight and molecular weight distribution, with good success. Along with its use as a plasma substitute, dextran, when cross-linked, found industrial use as a "molecular sieve" for the separation of polymers.

The division's program in surface chemistry might better be called one in colloid chemistry. Clearly concerned with keeping up with the rapid shift in industry from soaps to synthetic detergents, the division carried out a program on the characterization of the colloidal state of detergents in solution. Using the polymer chemistry techniques of viscometry and light scattering, the size and shape of micelles formed from anionic, cationic, and neutral detergents were determined. But these were complicated micelles because, in the ionic detergents, they had a charge, thus being more analogous to polyelectrolytes than neutral polymers. The charge was determined by electrophoresis, and much interesting and important information was collected.

The work in electrodeposition was for the most part concerned with the deposition of difficult metals, much of it supported by military agencies. Aluminum and molybdenum were of particular interest, but other metals, such as zirconium, titanium, and beryllium were also of concern. Since none of these can be deposited from aqueous solution, practically all the work was concerned with the important questions of deposition from nonaqueous solutions and fused salts. It was interesting work, more in the nature of process invention and development than research, but had no evident connection to the Bureau's standards and measurement functions, which probably bothered the Kelly Committee.

During the period 1950-1957, there was no obvious change in the program of the division. Its work had kept up with the needs of the times but, at least in organization, it remained a large and somewhat disparate collection of work. That this began to be of concern to Bureau management is shown in the method of describing the division's work in the Annual Report. Up to 1956 the reporting was done by the eleven division sections, or even subdivisions of those sections. In 1956 there was a definite change with the work reported in six categories that were only slightly related to the division organization. And in 1957 the work was reported in only four categories, three

---

<sup>161</sup> MFP, 151-152, 265.



In this apparatus developed by NBS for the electrodeposition of molybdenum from fused salts, the molybdenum was deposited from a solution of potassium hexachloromolybdate (III) in a molten mixture of alkali halides. Heat was supplied by an induction furnace (center). The glass cylinder projecting out of the furnace contained the molten mixture within a graphite crucible. An argon atmosphere was used in the glass cylinder to prevent contamination.

of which were discipline oriented: inorganic and analytical chemistry, physical and electrochemistry, organic chemistry, and air pollution. This was a harbinger of the changes to come when the division would be divided in two in 1960, and another step would be taken in implementing Astin's response to the Kelly Committee Report.



## MECHANICS

Involved in research on the mechanics of solids, liquids, and gases, the Mechanics Division, under its chief, Walter Ramberg, also worked on the mechanics of structures, in fluid mechanics, in the measurement of sound and vibrations, and in the measurement of various mechanical properties of materials. It had custody of mechanical standards such as those of pressure and flow rates in fluids, and calibrated flow meters, strain gages, microphones, and related instruments. More important, it had custody of the standard kilogram and calibrated weights and measures of capacity. It also undertook the acceptance testing of structural materials, mechanical appliances, and instruments for other government agencies, industry, and the public. In mid-1953 it was a large division with a total staff of 194 (129 professionals) organized into seven sections,<sup>162</sup> two of which, Hydraulics and Mass, the Kelly Committee found in need of attention. A full 69 percent of the division's work was supported by other agencies, with the military and the National Advisory Committee for Aeronautics the main sponsors.

Considering its capabilities and its sponsors, it is not surprising that a large thrust of the division's work was concerned with high-speed jet aircraft and rocketry problems. This work continued throughout the whole period with three main directions: air flow past a surface and turbulence in the boundary layer, the response of aircraft structures to imposed loads, and the use of the Bureau's electronic computer, SEAC, for various engineering calculations.

The study of turbulence made good progress in a very difficult field. It featured the use of a hot-wire anemometer to measure velocities, density, and temperature of the flowing air at velocities up to twice the speed of sound. The sensing element of the instrument was made from platinum-rhodium alloy wire only 1.2  $\mu\text{m}$  in diameter. Since this wire was tiny, the frequency response was enormous, approaching 70 kHz. Its small size meant that rapidly varying quantities could be measured in a small region and mapped out by moving the sensor. One of the first discoveries was that the transition from a turbulent boundary layer to the laminar-flow region above it was diffuse rather than sharp, with fingers of turbulence reaching up into the laminar region. In this transition region, the flow is alternately chaotic and laminar. Turbulent spots first form, then grow as they move downstream, and it was possible to measure their "rate of propagation, shape, and other significant features."<sup>163</sup> It was also found that surface roughness influenced the transition layer, with greater roughness inducing a transition at lower velocities, but this was also influenced by the nature of the roughness.

The work on aircraft structures was partly theoretical and partly experimental, the latter sometimes concerned with matters of aircraft performance or durability and sometimes with matters of aircraft production. Thus, driven by the industrial need to

---

<sup>162</sup> The sections were Sound; Mechanical Instruments; Aerodynamics; Engineering Mechanics; Hydraulics; Mass; and Capacity. Density, and Fluid Meters. A year later Hydraulics was abolished, Aerodynamics was changed to Fluid Mechanics, and a new section, Combustion and Controls, was added.

<sup>163</sup> Annual Report, 1955: 49.

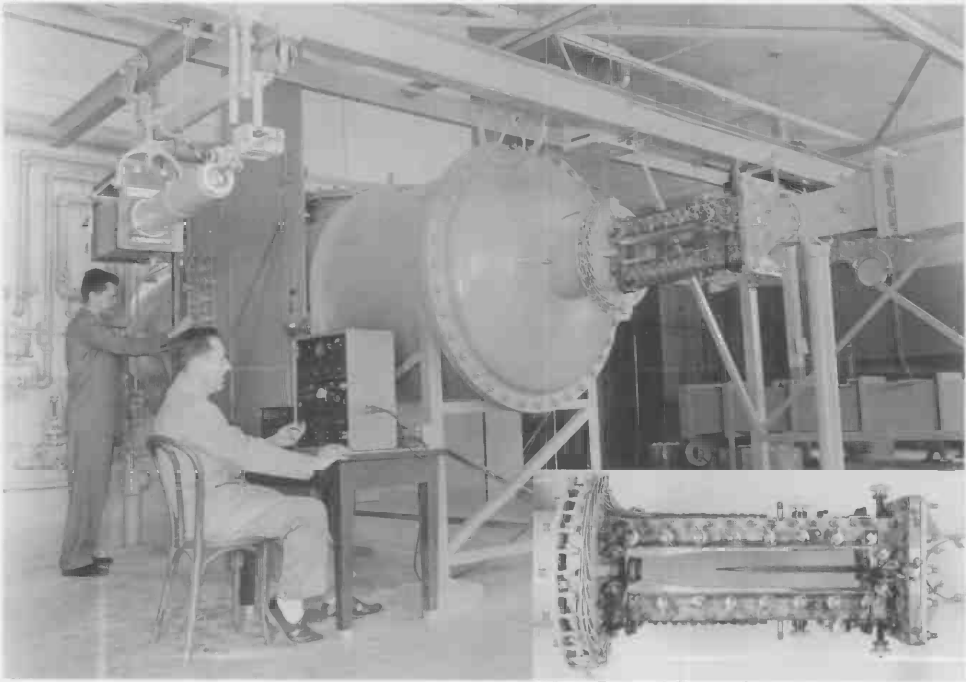

The NBS supersonic wind tunnel produced wind velocities up to twice the speed of sound. Inset: Close-up of the test section shows the hot-wire anemometer probe mounted in the central part. Direction of air flow is from left to right. The glass sides of the test section permit schlieren pictures to be made of the air flow.

determine the formability of high-strength aircraft sheet, a photo-grid technique for accurately determining elongation was developed, and a light, stiffened skin composed of two facing sheets separated by spacers was developed. The mechanical properties of aircraft structures of most concern were fatigue and creep, the latter driven by the high temperatures generated in the aircraft skin during operation at high speeds. The main aim of the work, and one that underlay all this research, was not merely to measure the common mechanical properties of materials, but to see how materials behaved in structures with their inevitable rivets, windows and doors, and various other types of stress raisers. In fatigue, for example, the fatigue strength of beams with rivet holes in them was measured and compared with the strength of smooth specimens, and in 1955 a test program was begun to determine the fatigue life of aircraft beams under the spectrum of loads typical of aircraft maneuvers.

The theoretical work developed into the use of the SEAC in aircraft engineering problems. An example was the use of the computer to calculate the deflection of tapered cantilever beams per unit load—a calculation that took three minutes on the machine, but which would have taken two days to do by hand. Other uses were in the structural analysis of delta wings; in vibration problems for computing the normal modes of aircraft, using a model with 63 degrees of freedom; in the calculation of temperature distributions, again driven by concern for high-speed flight; and in analytically evaluating the load-carrying capacity of the whole structure prior to testing.

After its formation, the Combustion and Controls Section was also involved in aircraft work with the study of jet-engine combustion and the development of a combustion chamber, and on jet-engine controls, particularly thermocouples which are used to prevent the occurrence of dangerously-high temperatures at the jet-engine exhaust.

When considered with additional projects, such as the measurement of the moisture content of the atmosphere at high altitudes; the development of n-heptane as a standard metering fluid for aircraft carburetors; and the instrumentation of a control stick to determine the forces exerted by the pilot, it is clear that a large part of the division, while doing valuable work, was almost an adjunct of the military and civilian government aviation agencies. There was no indication that the situation was about to change.

In addition to the work on turbulence just described, the division carried out research on flow in liquids. In particular, there was considerable work on aspects of liquid flow in bodies of water in different situations. Three main problems were addressed over a number of years: the effects that occur when a dam breaks; the effect of wind in causing waves in shallow bodies, driven by concern for the effect of hurricanes in such bodies of water as Lake Okechobee and shallow reservoirs; and density-driven flows at the mouth of estuaries where salt water mixes with fresh. In each case, both theoretical and experimental approaches were taken, with generally important results. For example, in a dam break it was found that the roughness of the surface of the valley through which the water rushes is important in controlling the flow, and that at the beginning of the flow from the break, the viscosity of the water rather than the resistance of the turbulence, is important in determining the flow. In the wind-wave coupling problem, it was possible to "illuminate certain aspects of energy transfer"<sup>164</sup> from wind to waves, and thus provide a means for estimating the magnitude of waves and tides. Finally, in the density-driven flow problem, it was possible to estimate the effect of such properties as density differences, river velocity, depth of channel, etc., on the characteristics of the density-current flow.

The division had a vigorous and productive program in sound and its sibling, vibration. A large part of it consisted of the unique Bureau functions of calibration of instruments, primarily microphones and vibration pickups, but it extended into other areas of the science of acoustics. In the calibration of microphones and pickups, the general thrust of the work was to increase the frequency range over which the services could be provided, and to measure high-level noises such as found near jet engines. Thus, while work was started to extend the upper frequency limit of the calibration range of microphones to 100 kHz, the range of microphones having absolute calibrations was extended from 50 Hz to 10 000 Hz up to 1 Hz to 20 000 Hz. The main problem in the measurement of jet noise is that the sound level is so high that microphones can be damaged. To measure such loud sounds, a null method was devised to protect the sensitive microphone, and the same arrangement proved to be useful as a sound source in calibrating vibration pickups. Since noise from a jet engine can be loud enough to cause hearing damage, the Sound Section began to look for ways to reduce jet noise. A method was developed to measure the total sound energy produced by a jet engine which was then applied to models of jets and to various devices proposed to reduce the noise level.

---

<sup>164</sup> Annual Report, 1955: 48.

The measurement of sound velocity, as might be expected, was an area of some activity. Careful measurement of sound velocity in monatomic gases found a very small degree of dispersion; it was the first time such observations had been made. In a completely different application, an instrument was developed for the continuous determination of sound velocity in sea water. Sound was also used to measure physical properties of materials, leading to the production of an instrument that continuously measured the viscosity of gases. Sound measurements are also necessary for architectural purposes, and in the area of architectural acoustics, improved methods of measurement of transmission loss through walls were developed, as well as improved methods for the measurement of reverberation. Not only was sound investigated, but also its physical perception, or hearing. Again, the emphasis was on measurements and their calibration. There was a considerable difference between the British and the U.S. standard sound pressures for the threshold of hearing, with the British standard being a full 10 decibels lower than the U.S. standard. To investigate this difference, a program to measure the sound pressure in the ear canal at the threshold of hearing was started on 100 persons and eventually led to the study of measuring the acoustic impedance of the ear to an earphone. Also concerned with hearing was the calibration of bone-conduction hearing aids. Measurements on a human head led to the conclusion that it would be possible to make a model of a human head, or "mastoid," that could be used for calibrating such devices.

One of the most important quantities derived directly from the basic units of mass, length, and time is force, and its relatives, stress and pressure, are equally important. Hence one of the basic functions of the division was to provide standards for these quantities, and the main thrust of the work was to extend the range over which standards and calibration services could be provided. In force measurements, four 3 million pound capacity compression dynamometers for use in calibrating large testing machines were themselves calibrated. The dynamometers used wire-resistance strain gages as output devices and increased the range over which calibrations could be performed from 2.6 million pounds to 12 million pounds. The same need to extend the scale was felt in pressure measurements. At the high end, a new piston gage to serve as the national standard in the range from 50 000 psi to 200 000 psi was built. At the low end, responding to needs from high-altitude flight, the development of an instrument for accurate measurements of pressures up to two inches of mercury was undertaken. While all this pressure work was going on, the development of the diamond-anvil cell in the Mineral Products Division would revolutionize the attainment of very high pressures.

In the Mass Section, the division had custody of the standard kilogram that was the national standard of mass. The section spent most of its time carrying out calibrations which, in the words of the Kelly Committee, "requires great technical skill but relatively little scientific knowledge." The committee went on to point out that "some imagination and scientific knowledge might be introduced in this area."<sup>165</sup> There is no evidence that this was done. In 1950 a re-evaluation of the equal-armed, double-beam

---

<sup>165</sup> Kelly Committee Report: 45.

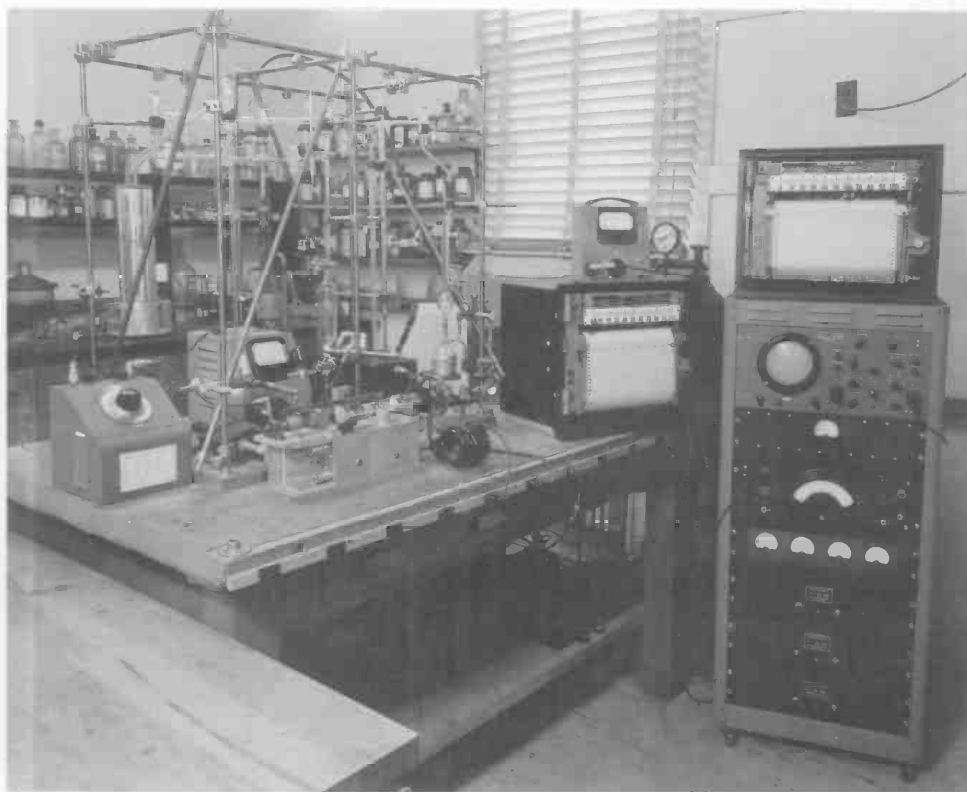

Apparatus used by NBS in studies of sound propagation through gases. The superstructure on the table supported equipment for measuring the pressure of gas in the double-crystal interferometer on the table in front of it. The cabinet on the right contained the principal electrical circuits for measuring the phase and amplitude of the sound that traversed the test gas. Instruments for automatically recording the phase and amplitude were above the cabinet and at the right end of the table.

balance was undertaken (results not known), and in 1955 a double-beam balance with a capacity of 1000 lb was constructed. With a sensitivity of about 500 mg, a half-ton weight could be calibrated to one part per million. It was designed to be used by state weights and measures laboratories, and working drawings were made available to balance and scale manufacturers.

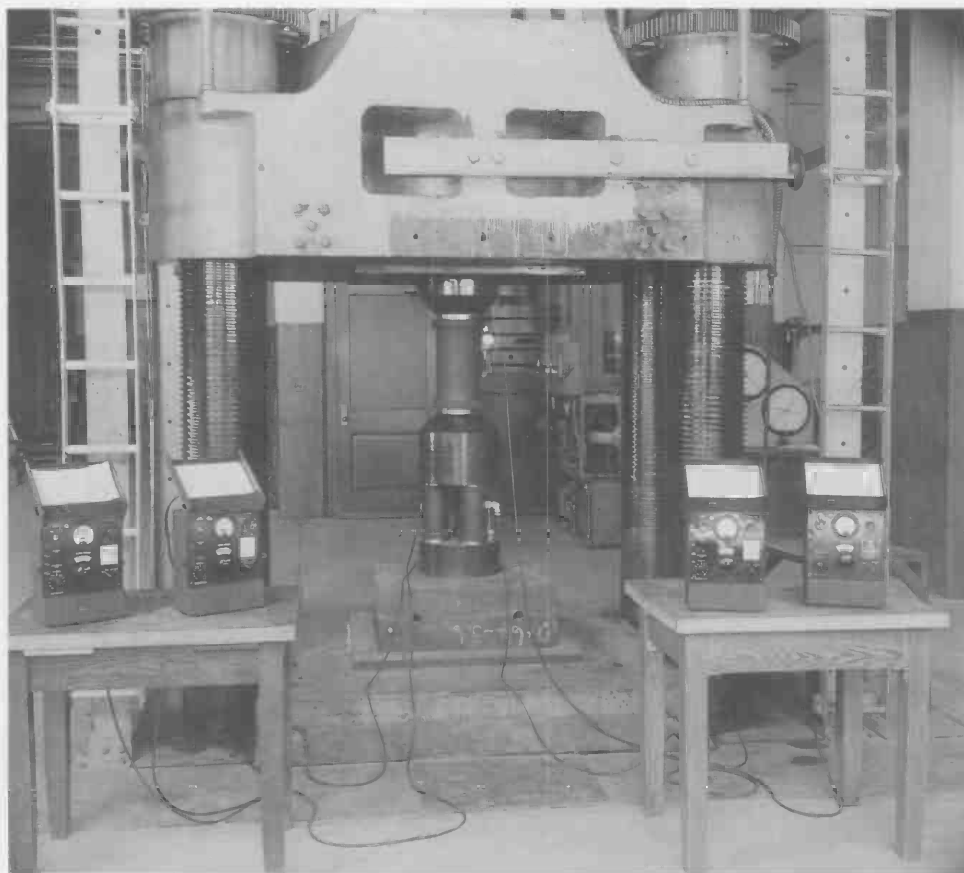

This setup in the NBS 10-million-pound testing machine demonstrated the calibration procedure for a 3-million-pound dynamometer. The device was loaded against three 1-million-pound dynamometers which had previously been calibrated.

### **MATERIALS RESEARCH**

The bulk of the Bureau's materials work was carried out in three divisions: Organic and Fibrous Materials, Metallurgy, and Mineral Products, representing—at least in the fifties—the major classes of materials in the economy. There was also specialized work on materials in other divisions, such as rheology of polymers and thermodynamic properties in the Heat and Power Division, and dielectric properties in the Electricity Division, but these were relatively small efforts. In 1953, the three materials divisions had a combined staff of 478, of whom 284 were professionals. These three divisions did testing and specifications development but in widely varying degrees. Thus, 17 percent of the total funds in Organic and Fibrous Materials, were expended in these categories; in Metallurgy the funding percentage was 9.7 percent; and in Mineral Products it was a very substantial 40 percent, mostly for acceptance testing of

portland cement for the Government.<sup>166</sup> Also showing wide disparity were division sizes and the fraction of transferred funds that each had. The largest of the materials divisions was Mineral Products with a staff of 244, only 121 of whom were professionals. Organic and Fibrous Materials had a staff of 169, but 115 were professionals, and Metallurgy—the smallest of the Bureau's seventeen divisions—had a staff of 68, 48 of whom were professionals. Other agency funds also showed wide disparity, with percentages of 68 percent for Organic and Fibrous Materials, 48 percent for Metallurgy, and 82 percent for Mineral Products.

These divisions were all concerned with the basic problems of materials science: the enhancement of desirable properties, the relation between properties and microstructure, determining degradation mechanisms, measuring and improving durability, and the synthesis of new materials. Of course, the nature of the materials determined the actual work carried out.

### **Organic and Fibrous Materials**

This division was organized partly along materials lines and partly along discipline-related lines. Thus, five of its eight sections were named after materials—Rubber, Textiles, Paper, Leather, and Organic Plastics—and two were more generally oriented—Polymer Structure, and Testing and Specifications. The Polymer Structure Section was the division's basic research section; and the Testing and Specifications Section handled all of the division's testing and specifications work, but the technical personnel come from the other sections. The eighth section was Dental Research, a special case.

The division's work is best described as coming under natural polymers—cellulosic and proteinaceous—concerning materials such as leather and paper, and under synthetic polymers—plastics and elastomers, although the latter includes natural rubber.<sup>167</sup> The development of the synthetic polymer area formed the bulk of the scientific and industrial activity in polymeric materials.

In studies of elastomers and plastics, the principal areas of concern were mechanical properties and their time dependences; failure mechanisms of plastics; various thermodynamic properties, but particularly crystallization; the degradation of plastics; and some synthesis work. Late in the period, with the purchase of an ultracentrifuge, solution studies began seriously, leading eventually to standard samples for molecular weight.

The mechanical properties work was a mixture of basic and applied, the basic primarily in the area of natural and synthetic rubbers, and the applied generally in plastics. This plastics work was largely supported by the military and was concerned with various aircraft problems.

---

<sup>166</sup> Kelly Committee Report: 48-57.

<sup>167</sup> The division played an important part in the wartime development of synthetic rubber. A good account is given in MFP, 410-414.

In the work on rubbers using polyisobutylene as a model elastomer, the temperature dependence of viscosity was determined to be the same as that of the "retarded elasticity," a result that would later find expression in equations for the temperature dependence of all viscoelastic properties of elastomers. Then, in a study of pure gum vulcanizates—such as a cross-linked elastomer without filler, such as a rubber band—it was found that the ratio of Young's modulus to stress was a specific function of the elongation. Applicable to both natural rubber and a number of synthetic rubbers, as well as to creep in tension, the expression was not applicable to elastomers containing carbon black. In subsequent work, apparatus for measuring bulk modulus at frequencies of 50 Hz to 5000 Hz was developed. The apparatus would be used to study the behavior of rubbers in the low-temperature region in which the rubber converts from an elastic material to a hard plastic.

The work on the mechanical properties of plastics was much more directed. One study was on aircraft canopies, which were made of acrylic. The study was designed to find the source of mechanical failure in the canopies, which crazed extensively in service, especially when laminated with a sheet of polyvinyl butyral to protect against impact damage. The Bureau found that if the acrylic is biaxially stretched, the tendency to craze almost disappears, and the acrylic develops the high-impact properties of the laminate. In a similar vein, in a study of the failure of aircraft windows, it was found that creep under the thermal gradient existing in the windows during flight leads to failure, and that this occurs more readily with thermosetting resins than with thermoplastics. Perhaps the most important results of these studies were the stimulation of research on the nature of crazes and the microscopical study of fracture surfaces. These studies provided important evidence for what was later learned about crazes, namely that, unlike a crack, the two surfaces of the craze are connected by a forest of fine fibrils.

Thermodynamic studies were carried out, particularly on the glass transition and on crystallization. The glass transition of silicone rubber was measured to assess its utility as an elastomer at low temperatures, but a study of the effect of pressure on the glass transition temperature was scientifically more interesting. Contrary to what was later found for this subtle measurement, these early measurements found no effect. The glass transition temperature of copolymers was also investigated, and by analysis of published data, an expression for calculating the glass temperature of copolymers from those of their constituents was developed. But perhaps better known were the division's studies on crystallization in polymers. Such studies demonstrated crystallization in the various forms of natural rubber and other polymers, and found that a melting point exists. The determination of its actual thermodynamic value would, however, depend upon techniques developed elsewhere in the Bureau.

Degradation of polymers was a concern, but under specific conditions. The action of temperature, oxygen, and ultraviolet radiation on polystyrene—one of the components of GR-S (Government Rubber-Styrene, a copolymer of butadiene and styrene) synthetic rubber—was chosen. Using ultraviolet, infrared, and mass spectrometry to detect reaction products, it was possible to deduce the reactions involved and to postulate mechanisms for them. This work developed into a study of polymer behavior under the action of high-energy radiation to attempt to deduce why some polymers are degraded by this treatment while others had their properties enhanced. Using a new



2520-curie cobalt-60 source for the studies, it was found that reactions proceed by free radical intermediates, and the course of a reaction could lead to desirable cross-linking, or in other cases to undesirable depolymerization. As a corollary to these degradation studies, new polymers (generally fluorine-containing) with elastomeric properties for use at high temperatures were synthesized. Driven by aerospace concerns, this work was to continue for some time.

Finally, somewhat as a legacy from the division's work on synthetic rubber during World War II, there were a number of other studies in rubber, both natural and synthetic. A program for the standardization of Government synthetic rubbers was begun involving methods for chemical analysis and physical testing. The analysis of mixtures of GR-S synthetic rubber and natural rubber was accomplished by thermally decomposing the rubber and using infrared spectroscopy to analyze the decomposition products. In a somewhat unrelated activity, the heat of vulcanization of natural rubber was determined by adiabatic calorimetry.

The division's work in natural polymers and the products derived from them—leather, paper, textiles—grew out of the Bureau's work in acceptance testing for Government purchases. This led to the development of many tests for often specialized properties—fold endurance of paper and abrasion resistance of textiles are examples—used in such testing, and in specifications for these materials. And one of the major concerns was durability and the laboratory means for assessing it. By 1950 the division was expert in all these subjects, as attested by its work in preserving the Charters of Freedom. Along with, and supporting this work, were more fundamental studies on various aspects of the natural materials involved, such as cotton, silk, wool, and collagen.

During the period, there was work on the structure of collagen and cotton. In cotton, the aim of the research was to determine both the external and "internal" surface areas. The latter includes the interface between crystallites and amorphous regions in the model of cellulose structure generally accepted at that time. Measurements of those areas by nitrogen adsorption at liquid nitrogen temperatures on untreated cotton, and on cotton which had been swollen with water and then had the water removed by a process of solvent exchange, showed that the internal surface area can be up to eighty times the external surface area. It varied greatly, however, depending on the treatment of the cotton. In collagen studies, the amino acid composition was determined by paper chromatography, replacing older and far more tedious techniques. Seventeen of the eighteen amino acids were determined, all on the same sample of collagen. In related work, the pore structure of leather was measured microscopically down to the actual collagen fibrils. The studies showed that a myriad of pores exist in sizes down to less than 0.1  $\mu\text{m}$ . In another background study, the moisture content of leather as a function of relative humidity was determined at several temperatures. This permitted the calculation of heats, entropies, and free-energies for the water-absorption process. The study was then extended to development of a new method for the determination of water-vapor permeability of leathers. This was accomplished, and the time for making these measurements was decreased from four days to one.



An NBS staff member inspected chromatograms used in determining the amino acid content of collagen, parent substance of leather. In the NBS-developed method, each component appeared as a separate colored patch on a sheet of cellulose paper. The amount of each amino acid present was determined by comparing the optical densities of the extracted patches with the appropriate calibration curves.

The main emphasis of the studies on these natural materials, was, however, on their durability. Concerned with all the final products, from fur skins to shoe soles, these studies extended throughout the fifties. One of the main products studied was paper, as it had always been. Here a number of studies were performed: the development of a method to measure aldehyde content, which was known to rise when paper degrades in storage; the degradation of cellulose by ultraviolet light, which was shown to be caused by photolysis of the alcohol groups in the cellulose to produce hydrogen gas and an aldehyde; and in ground-wood papers, where it was shown that clay coatings protect the paper from ultraviolet light. But perhaps the most important study, and one in which the Bureau made a unique contribution, was one that lasted twenty-six years. To put accelerated aging tests on a firm basis, the division had in 1928 artificially aged some commercial rag papers by heating them to 100 °C for 72 hours. Properties of the papers before and after aging were determined. Samples of the artificially-aged and original papers were then stored and periodically tested. After 26 years the final assessment was made. Results showed that there was a fair correlation between accelerated aging and natural aging for changes in physical properties (i.e., the folding endurance decreased to half its value), but there was very little change in chemical properties. Besides putting the accelerated aging tests on a firmer basis, the results showed that a "distinction must be



Thelma Worksman measured the folding endurance of a paper specimen. The specimen was alternately folded, under 1 kilogram tension, in opposite directions until failure occurred. The number of folds until failure was indicated on the small horizontal wheel behind and right of the specimen. Statistical analysis of the Bureau's data on folding endurance showed a fair correlation between natural and accelerated aging.

made between the permanence of the cellulose fibers and that of the properties of the paper sheet."<sup>168</sup>

Durability studies were not limited to paper. In other studies it was found that the presence of copper salts used in dyeing was correlated with the weakening of fur skins. A study of the effects of nitrogen tetroxide, an air contaminant found in smog, indicated that the natural cellulosic fibers from cotton and ramie were degraded, but the chemically similar viscose rayon was not. And a study of the effects of ozone on the degradation of cotton showed that the effect was small compared to other mechanisms of degradation.

Among all this polymers work was the special case of the Dental Research Section. Peopled almost entirely by research associates from the American Dental Association, this group was the principal research arm of American dentistry. Formed in the early 1920s,<sup>169</sup> the main areas of study were the structure of the tooth material itself, the development of new materials for dentistry, and the development of dental equipment.

Studies of the tooth material went on throughout the whole period, using primarily x-ray diffraction to determine the crystal structure of the tooth material, and fluor-

<sup>168</sup> Annual Report, 1955: 58.

<sup>169</sup> MFP, 271-272.

escence to denote the boundaries between the enamel and dentin phases of the tooth. It was established that the tooth consists of some form of hydroxyapatite ( $\text{Ca}_{10}(\text{PO}_4)_6(\text{OH})_2$ ) with a second phase of calcite,  $\text{CaCO}_3$ . The complicated calcium phosphate-calcium carbonate system merited continuous further study.

The dental materials studied were the dental amalgams, dental resins, and impression materials. Along with studies of the normal mercury-silver amalgam, a new approach was tried for the filling material. Alloys of gallium, chosen because its melting point is only  $29.5^\circ\text{C}$ , were tried as replacements for the standard system, but with uncertain results. The normal acrylic for dentures received considerable attention to improve its properties, and for impression plates, a mixture of zinc oxide and eugenol was tried, but it did not replace the standard material.

Significant advances were, however, made in dental equipment. A hydraulic-driven drill operating at 61 000 rpm promised to tame the dentists' instrument of torture, since it was well known that discomfort is greatly reduced as the rotational speed increases. And a panoramic x-ray machine was developed that could photograph the whole mouth with a single exposure.

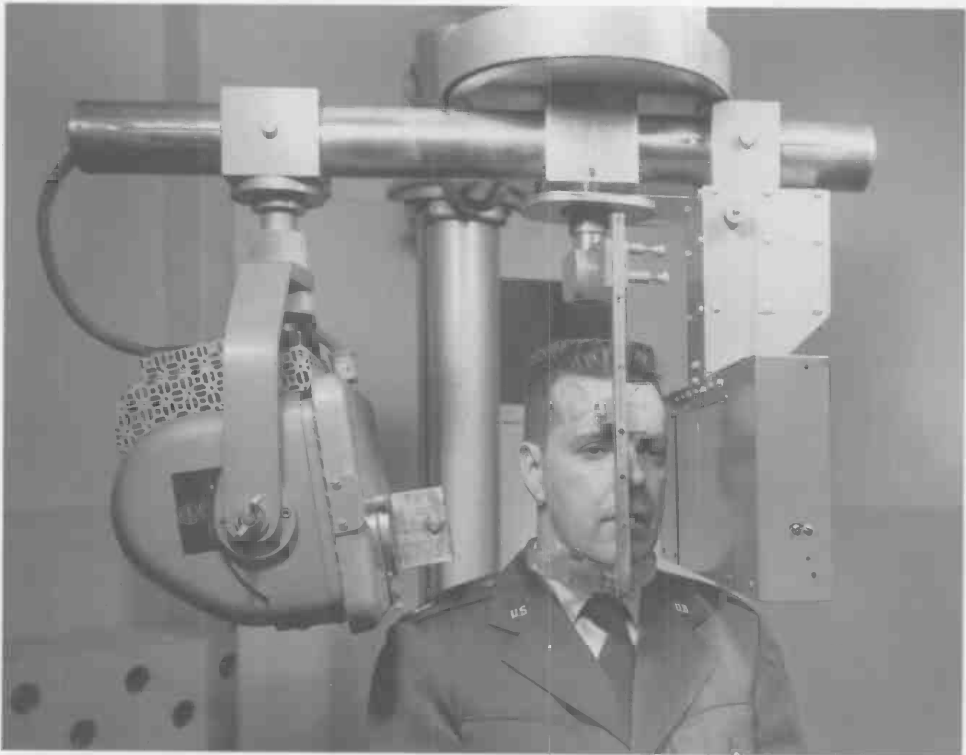

Developed by NBS in cooperation with the Air Force, the panoramic x-ray machine rapidly took a single x-ray picture of the entire dental arch.

## Metallurgy

The smallest of the Bureau's divisions at the time of the Kelly Committee study, the Metallurgy Division under John G. Thompson, was organized along strictly disciplinary lines. Its four sections were Thermal Metallurgy, Chemical Metallurgy, Mechanical Metallurgy, and Corrosion. The small size of the division and its lack of fundamental work, by which the committee clearly meant solid state physics, deeply disturbed the committee. Indeed, it went so far as to recommend that the Solid State Physics Section of the Atomic and Radiation Physics Division be transferred to Metallurgy. The transfer was not made, but in 1957 a new section, called Metal Physics, was established under the leadership of Lawrence M. Kushner, showing that Bureau management was eager to press on along the road to fundamental research.

The largest division activity was the study of mechanical properties. Two areas of continuous investigation were fatigue and creep, but tensile and impact properties were also of concern. In many cases, the materials studied were of military and aerospace interest. One very specific study was the fracture behavior of steel from failed ship plates, which is discussed in the next section.

Some of this mechanical work was designed to get at the fundamentals of the subject and some was, quite honestly, applied work. In fatigue studies of aluminum alloys, for example, it was found that prestressing, if done properly, could improve the fatigue life. Other studies were concerned with the determination of fatigue life of springs. In more fundamental studies it was shown that the increase in lattice spacing upon fatiguing was not related to fatigue failure, as had been postulated, but to cold work. A detailed study of crack initiation in fatigue in aluminum alloys found that cracks nucleated on slip bands. To study this process further, a small fatigue device that could be used under a microscope was built. With this device and time-lapse movies, the initiation of a crack was followed; it was found that at one stage of crack development, material is extruded from the incipient crack. In a similar study, the appearance of cracks in large-grained aluminum alloys under fatigue was studied by photometric recording. That study showed that the cracks were initiated in the interior of the grains rather than at the grain boundaries.

Another constant theme was creep. In a long program on the study of copper and nickel and their alloys, pure copper, nickel, and alloys of 70-30 and 30-70 copper-nickel were studied. In pure copper, cold drawing increased the creep resistance, as did strain aging in pure nickel. None of the existing equations for predicting creep behavior was found suitable for predicting the results.

Titanium, due to its high strength-to-weight ratio, and other high-strength metals were studied. The tensile properties of the former were studied down to liquid nitrogen temperatures, and notch sensitivity was tested under impact from 300 °C to -196 °C. As expected, the sensitivity increased as the temperature decreased, but differences in different lots were correlated with differences in the concentration of interstitial elements, particularly oxygen. In a related development for the military, the division entered into a program for the development of high-strength steel—over 250 000 lb/in<sup>2</sup>—with sufficient ductility for aircraft uses, such as for landing gears. Such alloys were developed, and fatigue properties were being determined near the end of the period.

In a more basic study, the plastic deformation of metals was studied by x rays and metallography in an ambitious attempt to identify the effects of dislocations, grain boundary migration, and lattice misorientation. It was found that changes in Young's modulus under applied stress are different in different directions, both for polycrystalline rods and for individual crystals.

The division had a significant effort in the preparation of pure materials. With this effort went the study of phases in alloys and the determination of constitution (phase) diagrams. Thus, in 1950 the division announced the preparation of ultra-pure iron, with a purity of 99.995 percent, and an even purer form with only 30 ppm of impurities was produced 3 years later. Highly pure samples of chromium were also made, and it was found that the metal was more ductile when dissolved gases were removed. And a number of studies of phases in various alloys were made such as graphite in nodular iron, where it was shown that the shape of the graphite phase, not its crystal structure, was what improved the ductility of the iron; the solubility of chromium carbides in stainless steel; and, inevitably, the conversion of martensite to austenite—the reaction responsible for the hardening and strengthening of most steels. But what is most impressive is the number of constitution diagrams that were determined. Spurred by atomic energy requirements, a number of binary phase diagrams of uranium with beryllium, titanium, silver, gold, and platinum were produced, as well as magnesium with several of the lanthanide metals. And spurred by jet-engine developments, the complex iron-chromium-nickel-molybdenum system used for turbine blade alloys was worked over thoroughly.

Toward the end of the period, the division began a project that brought it into cooperation with the metrologists in the Optics and Metrology Division. While the Bureau was capable of calibrating gage blocks to one part per million, industry needed an accuracy of one part in 10 million. It made no sense to provide this level of accuracy if the material (steel) from which the gage blocks were made was not dimensionally stable at the same level or better. The Metallurgy Division therefore began a program on developing ultra-stable gage blocks, and this continued as a cooperative project between the two divisions. Involving specialized heat and surface treatments, the problem was solved in later years.

With the transfer in 1947 of the Corrosion Section from the Electricity and Electronics Division (where it was called Underground Corrosion) to the Metallurgy Division, a new line of work was added to the division's program. Corrosion activities began at the Bureau in 1910 with the study of corrosion caused by stray currents. In 1922 this work was extended to a more general study of underground corrosion. Eventually the Bureau operated 128 test sites throughout the United States, representing all the major types of soils found in the Nation. At these sites, samples of metals of very different kinds were buried, periodically unearthed, and their condition assessed. With this history, it is not surprising that the work of the section was in part very practically oriented and, in part, less directly applicable laboratory work.

By the fifties, the underground corrosion studies had been developed and extended to other forms of environmental corrosion. Exposure sites were set up at Hampton

Roads, Virginia, for atmospheric corrosion in a marine environment, and in Washington for an inland atmosphere. With support from the Navy, a large number of samples of various stainless steels and aluminum and magnesium alloys were exposed at these sites. Metals for more general use, such as aluminum for house sidings, were also assessed. The underground corrosion work continued with, however, a background research effort, the culmination of which was the development of an electrochemical technique for determining the instantaneous rate of corrosion of a buried specimen. And in 1957, "a final report on the studies of underground corrosion conducted by the National Bureau of Standards" was published.<sup>170</sup> Authored by Melvin Romanoff, and containing a detailed account of all the Bureau's results at the 128 test sites, this publication became the bible of the corrosion engineer.

Laboratory research work in corrosion centered about two main themes: the corrosion rates of different faces in metal single crystals, and stress corrosion. In the single-crystal work, aluminum and copper single crystals were studied. With the aluminum crystals it was found that in acidic media, the  $\langle 111 \rangle$  crystal faces corroded more rapidly than the  $\langle 100 \rangle$  faces, while in basic media the opposite was true. Similar results were found with copper single crystals, where oxidation in the presence of water and oxygen was faster on some faces than on others. With the same system, it was found that light strongly increased the corrosion rate and indeed, for faces with a thick (1000 Å to 2000 Å) film, light helped the dissolution of the film.

The stress-corrosion cracking work was concerned with establishing mechanisms for this deleterious process, but progress was only hard-won. Generally, the studies seemed to confirm the accepted mechanism that crack growth starts at a break in the protective passive film, but how it continues remained a problem. In more specific studies with alpha brass and low-carbon steel, it was shown that cracks are intergranular and along those grain boundaries of high energy because of high crystalline mismatch between grains. But then the contrary result was found that, with beta brass, the cracks were transgranular. These were puzzling results.

## Ship Failures

Since all Federal Government agencies own equipment, from typewriters to aircraft carriers, they are naturally interested in the cause of failures of this equipment. In addition, some agencies are interested in such failures because, like the various agencies of the Department of Transportation, they have the responsibility to set regulations to prevent the failure of equipment, thus preventing injury and loss of life of the general public. Consequently, from the Bureau's very early years, other agencies have sent it pieces of failed equipment with a request to determine the cause of the failure. The Bureau's entry into underground corrosion began with the study of the corrosion of underground gas pipelines by stray currents from street railways. A number of interesting failures analyzed by the Bureau are described by John A. Bennett and G. Willard Quick in Circular 550.<sup>171</sup> Since most machinery and equipment is made of metals, the

<sup>170</sup> M. Romanoff. *Underground Corrosion*. Natl. Bur. Stand. (U.S.) Circular 579; April 1957.

<sup>171</sup> J. A. Bennett, G. W. Quick. *Mechanical Failures of Metals in Service*. Natl. Bur. Stand. (U.S.) Circular 550; September 1954.



Four test sites illustrative of the varying environments in which ferrous specimens were installed for periods of up to seventeen years in studies of underground corrosion. Upper, left to right, Lake Charles clay at El Vista, Texas; Merced silt loam at Buttonwillow, California. Lower, left to right, tidal marsh at Charleston, South Carolina; Hagerstown loam at Loch Raven, Maryland.



Metallurgy Division was generally involved, and because design problems may have contributed to the failures, the Mechanics Division sometimes became involved. In later years, building research scientists also took part and their participation extended to the investigation of natural disasters such as earthquakes.

One of the most important series of failure investigations in the Bureau's history began in 1942 and was not ended until a final report was published in 1953.<sup>172</sup> Recognizing that shipping was to be a crucial factor in World War II, the Nation began a crash program of building merchant ships of various kinds and designs. To speed up the process of building the ships, the customary riveted construction of the ships was foregone for welding, which was much faster and provided more leak-proof joints.

But almost immediately dire things began to happen. Some of the ships began to fail, a few by a crack running through the whole structure approximately amidships and transverse to the long axis of the ship, leaving the ship in two pieces. Others developed cracks of various sizes which, however, stopped before traversing the whole structure. These occurrences could have had a serious effect on the war effort, and in April 1943 the secretary of the navy convened a board of investigation to look into the problem. The board appointed a sub-board which set up and directed the execution of all phases of the inquiry as set forth by the board.<sup>173</sup> The board undertook a complete investigation of the problem, including technical and statistical analyses of all fractures; strength of the vessels; their loading and ballasting conditions; convoy routes; and, important from the Bureau's point of view, a laboratory study of the design, fabrication, and materials used in the construction of welded ships. The board made its final report in 1946,<sup>174</sup> at which time its work was continued by the Ship Structures Committee, with the same membership plus the U.S. Army Transportation Corps. This committee supported the Bureau work from 1947 until its ending in 1953.

The problem was not a small one. By April 1946, 4694 ships had been built and 970 of them sustained "casualties" consisting of a total of 4720 fractures. Eight ships were lost: four were abandoned, one broke in two and was abandoned, and three broke in two with portions salvaged or scuttled. Another four broke in two but were not lost. Particularly important was the nature of the fracture, for unlike the behavior of ship steels in a laboratory tension test, there was very little evidence of any ductility. In the words of the board of investigation, "The fractures, in many cases, manifested

---

<sup>172</sup> M. L. Williams, G. A. Ellinger, "Investigation of Structural Failures of Welded Ships," *Welding Journal, Welding Research Supplement* 32 (1953): 498s-527s; M. L. Williams, G. A. Ellinger, "Investigation of Fractured Plates Removed From Welded Ships," NBS Report, Dec. 9, 1948; "Failures in Welded Ships," *Technical News Bulletin* 37 (1953): 24-29.

<sup>173</sup> The members of the board of investigation were engineer-in-chief, U.S. Coast Guard; chief, Bureau of Ships, USN; vice chairman, Maritime Commission; and chief surveyor, American Bureau of Shipping. The sub-board consisted of representatives of the four member agencies and the War Metallurgy Committee of the National Academy of Sciences.

<sup>174</sup> "Final Report of a Board of Investigation Convened by Order of the Secretary of the Navy to Inquire Into the Design and Methods of Construction of Welded Steel Merchant Vessels," *Welding Journal* 26 (1947): 569-619.

themselves with explosive suddenness and exhibited a quality of brittleness which was not ordinarily associated with the behavior of a normally ductile material such as ship steel."<sup>175</sup> The fracture surface did not have the appearance of that seen in tensile tests and, most telling of all, there was no thinning of the material right up to the fracture surface. Indeed, even the paint was continuous right up to the edge of the crack, with the paint layer cracking along the fracture. It was more like the cracking of glass than the failure of structural steel. Metallurgical knowledge at the time could not explain the phenomenon.

The Bureau was called in to help at the very beginning, and in 1943, after the formation of the board of investigation, the Bureau's position was formalized. Early in that year, all merchant ships received a communication from the Coast Guard with directions for removing samples of material from a fractured plate:

If steel is removed in repairing the fracture, two pieces about two feet square taken from opposite sides of the fracture and each including one side of the starting point, should be obtained. . . . Mark the steel samples with reference points. Indicate these reference points . . . on sketches . . . and then forward both samples and sketches to the Metallurgy Division, National Bureau of Standards, Washington, D.C.<sup>176</sup>

By 1952, the Bureau had received plates from 100 ships, sometimes receiving several plates from one ship. In all, the Bureau tested 130 plates.

The investigation of the plates by the Metallurgy Division consisted of visual inspection of the fracture surface to locate the origin of the fracture, followed by a detailed examination of the fractures and welds; chemical analysis of the plates; tension tests; metallographic examinations as appropriate and necessary; and, most important as it turned out, Charpy V-notch impact tests. These last tests proved to be of crucial importance. In part, they measure the energy required to fracture a specimen with a notch in it. The higher the energy necessary for fracture, the greater the material's "notch toughness." This turned out to be the crucial factor in the failure of the ships.<sup>177</sup>

The Mechanics Division did not work on these plates from failures. Their assignment was to measure the stress distribution in various complex ship structures, such as bulkhead intersections.<sup>178</sup>

---

<sup>175</sup> Ibid., 569.

<sup>176</sup> Ibid., 605.

<sup>177</sup> In detail, the specimen is a bar 55 mm × 10 mm × 10 mm. A carefully shaped transverse notch 2 mm deep is machined at the center of one of the lateral surfaces. The specimen is supported at its ends and is impacted with a pendulum hammer on the surface behind the notch, thus breaking the bar. Measurement of the resulting amplitude of the pendulum swing gives the energy necessary to break the specimen. This is done over a range of temperatures. The notch toughness decreases with temperature, from typically over 50 ft lbf at 70° to 100 °F to 5 ft lbf or less at 30 °F or lower for these ship plate steels. The tensile strength as measured on smooth tensile specimens rises with decreasing temperature.

<sup>178</sup> The results of the work of the Mechanics Division are given by William R. Campbell, "Stress Studies of Welded Ship Structure Specimens." *Welding Journal* 30 (1951): 68s-77s.

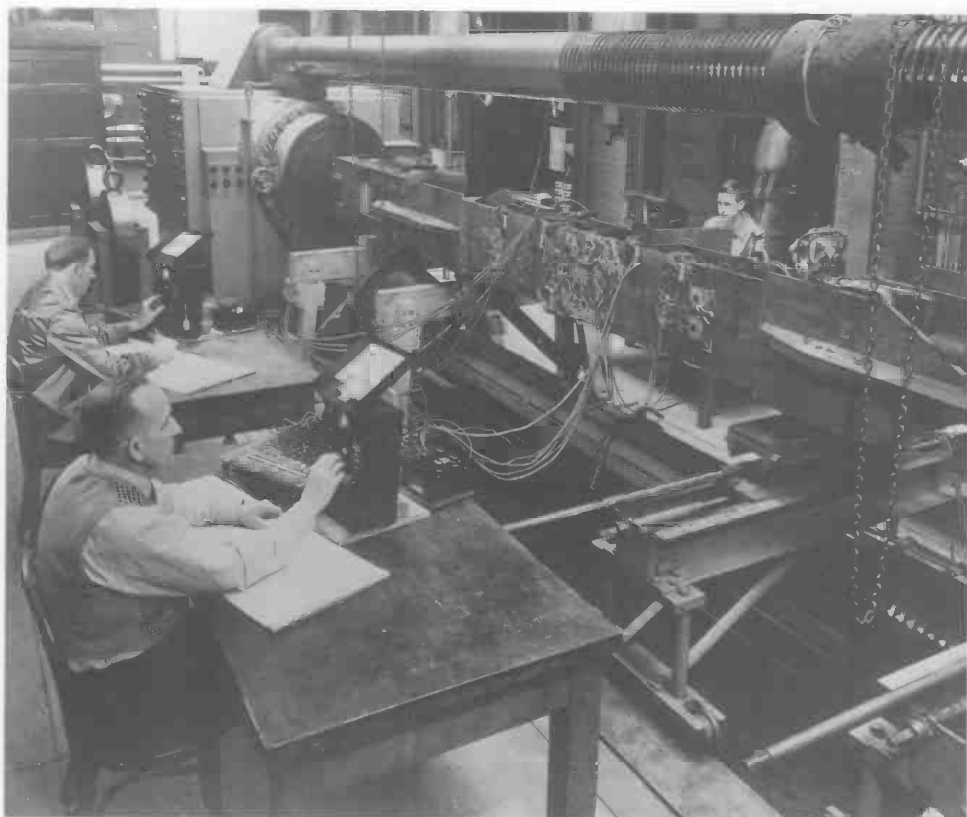

NBS staff from the Metallurgy Division took data during a tensile test at room temperature of an interrupted longitudinal specimen from a ship plate.

In its study of the fractured plates, the Metallurgy Division workers found, “the starting points of the fractures could be traced, invariably, to a point of stress concentration at a notch resulting from structural or design details, welding defects, metallurgical imperfections or accidental damage.” In short, the notch could be any stress raiser from a sharp corner on a hatch to a position of incomplete penetration in a weld. They also found that the steel in the plates passed the tensile strength and composition requirements. In looking at the service record of the failures, however, it was seen that there were relatively more failures at lower temperatures, and “the few failures that did occur at temperatures higher than about 50 °F were not as extensive or serious as many of the failures which occurred at lower temperatures.”<sup>179</sup>

These observations did not answer the question of why some ships failed and others of the same design and service did not. To answer this question, the Bureau workers divided all the plates examined into three categories: plates in which the fracture was

<sup>179</sup> Williams and Ellinger, “Investigation of Structural Failures of Welded Ships”: 522s.

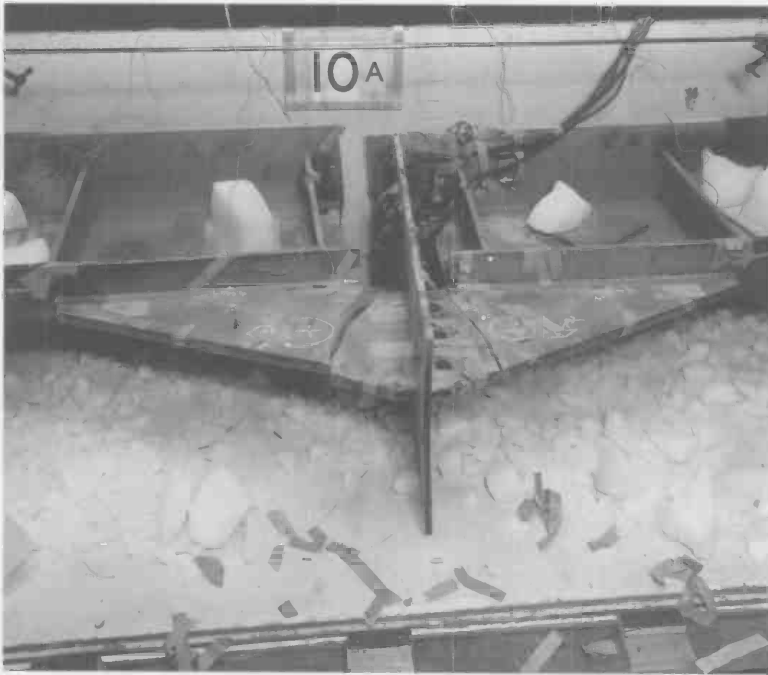

This interrupted longitudinal specimen from a ship plate was examined in the NBS Metallurgy Division immediately after fracture.

initiated ("source" plates), those through which the fracture propagated without stopping ("through" plates), and those in which the fracture stopped ("end" plates). Measurements of the notch-impact properties of the steel from these three types of plates led to the solution to the problem.

The laboratory results showed that when impact measurements were made at the temperature of failure in the ship, none of the source plates had a notch toughness as high as 15 ft lbf, the highest being 11.4 ft lbf. For the end plates, 33 percent had a notch toughness greater than 15 ft lbf, and the corresponding fraction of through plates was 9 percent. A value of fracture toughness of 15 ft lbf seemed to be critical. Consequently, a transition temperature, which was defined as that temperature at which the steel has a notch toughness of 15 ft lbf, was chosen as a criterion for comparison of the classes of plates.

When the plates were analyzed with this criterion in mind, it was found that the average transition temperature in degrees Fahrenheit for the source plates was 100.7, for the through plates it was 67.4, and for the end plates it was 53.0. These numbers imply that in the source plates, failure could occur up to temperatures of 100 °F; while for end plates, temperatures above 53 °F were safe. Moreover, a more careful statistical analysis brought out two very interesting facts. Looking at the distribution of transition temperatures, it was found that, while for the through plates the distribution was approximately normal, it was hardly so for the source and end plates. For the source plates the distribution was skewed toward higher temperature, with one of the plates

having a transition temperature of over 120 °F. For the end plates, the distribution was skewed toward lower temperature, with the highest transition temperature being 70 °F.

Now the conditions for failure could be qualitatively laid out. A plate with a low notch toughness, from the tail of a distribution curve, had to be at a critical location in the ship structure where there was a stress concentration at an appropriately low temperature. When these two conditions were met, a running crack could occur and lead to catastrophic failure. These conditions were rarely met, and indeed only a very few of the many thousands of ship plates manufactured and placed in service failed, suggesting that lack of notch toughness was a borderline condition, but nevertheless one that could lead to serious consequences.

The ship-failure problem was alleviated by design changes and improved welding practice. But increasing the notch toughness was a longer-range problem. The Bureau workers found that the composition of the steel was important, with carbon and phosphorus raising the transition temperature and manganese and silicon lowering it. Moreover, a finer grain size also improved the notch toughness, so that steel-making practice was important. These considerations were gradually incorporated into steel specifications, but the 15 ft lbf criterion became almost magical, being applied in cases where it had little relevance.

Aside from its value in helping the war effort, the ship-plate investigation spurred a new interest in basic metallurgy in making tough steels. But perhaps the most important effect it had was to reawaken interest in the science of fracture, which had lain dormant since the mid-twenties, by the development of fracture mechanics.

## **Mineral Products**

With a staff of 244 in 1953, the Mineral Products Division, under Irl C. Schoonover, was the largest of the materials divisions. Five of its sections—Porcelain and Pottery, Glass, Refractories, Enamelled Metals, and Concreting Materials—were concerned with products, and two—Constitution and Microstructure, and Chemistry of Mineral Products—with more general disciplinary topics. A full 40 percent of the division's funds were, however, expended in the acceptance testing of concreting materials and the associated standards and specifications.<sup>180</sup> The division maintained field stations for testing Government cement purchases in Seattle, Denver, San Francisco, and Allentown, Pennsylvania. This large amount of testing did not bother the Kelly Committee, which was concerned solely with Government purchases, but the activity would be discontinued by 1960 and the work taken over by research associates from the Portland Cement Association.

The broad research program of the division could be classified in six categories, some of which were centered in a single section, and others which crossed section lines. The categories were: cement and concrete studies, coatings for metals, glass, properties of ceramics and ceramics for special purposes, phase equilibria, and standard x-ray patterns and crystal structure determination.

---

<sup>180</sup> Kelly Committee Report: 56.

The testing and specifications work on cement and concrete was backed up with a broad program of basic and applied research. A mere listing of the various activities gives a flavor of the work carried out:

- Developed a means of speeding up standard tests for measuring heats of hydration of cements.
- Studied the properties (particularly strength) of refractory concretes at intermediate temperatures above those at which a hydraulic bond is formed, but below those at which a ceramic bond (sintering) is formed.
- Carried out studies on the durability of concreting materials under alternate freezing and thawing conditions, and studied the mechanism of reaction between some aggregates and the alkalis in cement. This reaction was known to cause deterioration and disintegration of concrete structures. In further durability studies, the reaction of portland cement with carbon dioxide was investigated. It was found that the reaction took place only in humid atmospheres, and carbon dioxide reduced the rate of hydration.
- Began a program of basic research on systems containing soda, potash, lime, alumina, ferric oxide, and silica in cooperation with the Portland Cement Association. The ambitious aim was "to learn the effects of every variable in composition and heat treatment as reflected in the behavior of the concrete."<sup>181</sup> This work led to an impressive number of phase-diagram studies of importance to cement and concrete. The studies included the systems lime-silica-water, lime-alumina-water, lime-alumina-silica-water, and multi-component systems of oxides of calcium, silica, and iron.
- Studied the nature of cement hydration compounds by x-ray and electron diffraction, and found particles of 5 nm to 20 nm that may have resulted from the hydration of calcium silicate.
- Investigated heat-resistant concrete for jet-aircraft airport aprons. The concrete was not very strong, and the mechanism of spalling was studied.

The work on ceramic coatings progressed on two fronts: the old one of porcelain-coated metals, and a new one concerned with more modern problems. As in other divisions, a great deal of work, supported by other agencies, was concerned with jet-aircraft and nuclear-reactor problems. In Mineral Products the concerns were with coatings for the protection of engine rotor blades and metals in nuclear reactors at high temperatures. It was found that a coating composed of powdered chromium mixed with a vitreous alkali-free ceramic substantially increased the lifetime of molybdenum at 1800 °F. Similar results, and the production of a rough surface, were obtained with a chromium boride-nickel cermet (a mixture of powdered metal and ceramic) as a coating. In studies designed to determine the cause of deterioration, it was shown that the cause was hydrogen liberated from water in the ceramic coating

---

<sup>181</sup> Annual Report, 1953-1954: 67.

at the high operating temperature. Continuing on the studies of the mechanism of adhesion, it was found that the roughness of the metal surface was important, but in another study on the bonding of ceramic to 18-chromium, 8-nickel stainless steel, copper ions in the ceramic were important in promoting adhesion to the metal. In results with related materials, it was found that a coating of barium silicate with dispersed fine particles of cerium oxide reduced the creep rate of 80-nickel, 20-chromium alloy by as much as 90 percent. This was thought to be caused by the ceramic preventing the diffusion of hydrogen into the metal.

In coatings for nuclear reactors, not only was high-temperature durability important, but also the coating must not absorb neutrons. The best material found was a boron-free coating of a barium type combined with ceria-chromic oxide. This had a satisfactorily low neutron absorption cross section, and it reduced the oxidation of the substrate metal by 50 percent to 75 percent.

In work on porcelain-coated metals, a program was started in which various items were placed in service in homes; their performance after a length of time was to be compared with that predicted by laboratory tests. While this new program was beginning, an older one was ending. In 1939, 864 porcelain samples had been placed on exposure racks to determine their weather resistance. In 1956 these samples were removed and brought into the laboratory for gloss and color difference measurements. The results were published.

At the beginning of World War I, the United States was not capable of making optical glass for its war effort. The Bureau began a crash program to learn how to make this type of glass and set up a plant for its manufacture. Research was carried out during the period between the two wars and the plant operated continuously throughout World War II.<sup>182</sup> The Korean War again called for the output of the plant. In the mid-fifties the Bureau's glass research consisted of two parts: production of special glasses for the military and research into the structure and properties of glasses.

The production of glass and the associated development work consisted of manufacturing new glasses with special properties, the development of a continuous melting process, and the production of large optical elements. New glasses with increased transmissivity at both ends of the spectrum—particularly in the near infrared—were developed. Working with the ternary system, consisting of barium oxide and silica, plus titanium dioxide, lanthanum oxide, or tantalum oxide, the Bureau was able to prepare a number of special glasses with particularly high refractive index, good transmittance in the infrared, high (>800 °C) deformation temperature, and good resistance to chemical attack. It was also successful in developing a continuous process for the production of glass for making large optical pieces with diameters ranging from 6 in to 20 in. And in a study for the navy, it learned how to make glass fibers with particularly high Young's modulus. Along with this development at work, it also manufactured optical glass, delivering 7500 lb to defense agencies in 1955.

---

<sup>182</sup> MFP, 187-188.



Dwight Moore of the Mineral Products Division examined enameled steel panels that had been exposed to the weather on the roof of the NBS industrial building for fifteen years. Similar specimens were exposed at St. Louis, Missouri, Lakeland, Florida, and Atlantic City, New Jersey. Measurement of changes in gloss and color were used to evaluate weather resistance of the various types of enamel that were included.

The work on the structure and properties of glasses was mainly concerned with the measurement of various physical properties of glasses of different types and composition and trying to deduce something about the atomic structure from the results. For example, studies of glasses containing alkali ions showed that the viscosity was independent of the size of the alkali ion, implying that the strength of the interatomic bonds, rather than the size of the ion, controlled the flow behavior. A number of studies were carried out on borate-alkali systems. These indicated that there was a great attraction between the alkali ions and the borates. When this study was extended to alkaline earth-borate glasses, it was found that there was liquid immiscibility, with two liquid phases being formed. The extent of this phenomenon was dependent on the nature of the alkaline earth. For example, the addition of calcium oxide in low concentrations to borate did not lead to immiscibility but actually decreased the volume to less than that occupied by the borate alone. But perhaps the most intriguing and basic experiments were concerned with the measurement of the residual entropy of glasses. Such measurements were started both calorimetrically by measurement of the





This high-temperature drop calorimeter was used in studies of the excess entropy of glass by Cornelius Pearson as he measured the vapor pressure of arsenic oxide in the crystalline and vitreous states to determine entropy of vaporization.

specific heat from absolute zero to a temperature above the melting point, and by the measurement of the vapor pressure of the glass and the same material in the crystalline phase.

The division's program on ceramics studies consisted of two parts: one concerned with ceramics for dielectric and piezoelectric uses, and the other comprising more general studies on ceramics for various purposes.

The dielectric and piezoelectric work was largely supported by the military and in the main was aimed at developing materials with better properties. For example, it was found that ceramics made from calcium titanate or from mixtures of titania with rare-earth oxides had resistivities greater than  $10^{10} \Omega \cdot \text{cm}$  at temperatures up to  $200^\circ\text{C}$ —results which exceeded the capabilities of commercial materials. Continuation of this type of work led to a composition  $\text{BaO} \cdot 5\text{TiO}_2$  with a dielectric constant of only 37, as compared with 100 for the standard barium titanate, but with a zero temperature coefficient in the range  $-40^\circ\text{C}$  to  $+200^\circ\text{C}$ , far exceeding the properties of the barium titanate. The work on piezoelectric materials had much the same orientation—the search for new compositions with enhanced properties. The system most studied was lead titanate-lead zirconate, but with the addition of other compounds, such as stannates or hafnates. Some compositions were found with good properties indeed. Late in the period, the work turned more basic. A study of the relationship between microstructure and piezoelectric properties was started in 1956. Using the technique of x-ray diffraction to characterize the particle size, state of strain and regularity of crystal

structure for barium-titanate powders prepared from the thermal decomposition of barium-titanium oxalate, strong changes in the x-ray pattern were noted during the processing of the material. Finally, in 1957, a method of production was found that assured single-domain crystals in the material, thus strongly enhancing its ferroelectric properties.

The division's work on ceramics for other purposes was concerned primarily with high-temperature uses and the measurement of properties at high temperatures—even on systems that are not normally considered ceramics. For example, the elongation and strength of graphite for nuclear reactors was measured in the temperature range 1800 °C to 2400 °C, and the service life of graphite crucibles for melting non-ferrous metals was determined. It had been believed that only graphite from Madagascar could be used for this purpose, but this work showed that domestic graphite was adequate. Other studies were performed on true ceramic materials; the following is a partial listing of projects:

- In work supported by the Atomic Energy Commission, the mutual compatibility of oxides, metals, and carbides was studied. In particular, the reactions of refractory materials with uranium oxide were determined. It was found that there was no solid solubility with alumina, beryllia, and silica, but extensive or complete solid solution occurred with five other refractories.
- A basic study of the thermal decomposition of crystalline inorganic compounds led to the study of carbonates because of their industrial importance, particularly ferrous and manganous carbonates. These are complicated materials to study because their decomposition is influenced by valence changes with temperature, the rate of heating, the composition of the atmosphere, and other factors. However, by the use of high-temperature x-ray diffraction, an automatic recording thermal balance, and differential thermal analysis, it was possible to determine the actual equilibrium conditions at various temperatures under air, carbon dioxide, and inert gas, and thus resolve the conflicting data in the literature.
- There was excellent work on mechanical properties supported by the Wright Air Development Command. The object of the program was the understanding of the mechanical properties of polycrystalline ceramics at high temperatures. The program started off with the measurement of properties of single crystals: sapphire ( $\text{Al}_2\text{O}_3$ ), rutile ( $\text{TiO}_2$ ), and periclase ( $\text{MgO}$ ). It was found that each of these began to deform at about one half their respective melting points, and the slip planes were determined as well as the shear stresses necessary to cause deformation. Later, the deformation of polycrystalline samples was studied. The creep, Young's modulus, and internal friction of alumina and magnesia were measured in the temperature range 1000 °C to 1300 °C. In alumina the creep was almost entirely recoverable, while in magnesia very little was. It was hypothesized that, in alumina, creep was by grain boundary slip, while in magnesia it was by slip within the grain. As part of the investigation

the elastic constants of 35 materials were determined at room temperatures. This important program was to continue and lead to some significant insights into the mechanical behavior of ceramics and indeed other materials.

- At high enough temperatures, vaporization can be an important problem for even high-melting-point ceramics, and for this reason the determination of vaporization processes at high temperatures was an important activity. Some results were astounding. With alumina at the melting point—2015 °C, achieved in a solar furnace—“the material volatilized at such a rate that the molten material appeared first to boil and then to freeze as it drew upon its own heat to maintain the volatilization process.”<sup>183</sup>
- Silica is one of the most important high-temperature materials, but it exists in several crystallographic modifications and a study of the conversion between crystalline forms was undertaken.

The division programs in phase equilibria and standard x-ray patterns had one aspect in common: they led to data compendia that became standard reference data. The phase equilibria studies were published in conjunction with the American Ceramic Society as *Phase Diagrams for Ceramists*, and the standard x-ray patterns, used for identification of unknown materials, were disseminated via a file of patterns located at the American Society for Testing and Materials (ASTM). Beginning in 1952 with one research associate, this x-ray program was sponsored by the Joint Committee on Chemical Analysis by Powder Diffraction Methods, consisting of members from ASTM, the American Crystallographic Association, and the Institute of Physics (U.K.). The number of associates eventually reached three, and the Bureau also provided financial support and leadership. The ASTM file was old and of doubtful accuracy, and the Bureau's work was to evaluate and correct the file as necessary, adding new patterns as appropriate. New and revised patterns from the literature and in-house work were published approximately yearly as Circular 593 until 1962, and thereafter as Monograph 25. By 1956 the Bureau had produced 300 patterns of high accuracy. These replaced 600 patterns in the ASTM file and added 74 new ones. The work was continuing, and would continue to the end of this history.

While x-ray diffraction methods were in widespread use in the division for many purposes, their use for the determination of crystal structure appears to have become an identifiable autonomous activity only about the middle of the period. This, of course, was when computers and computer programs became useful for the tedious calculations necessary to convert x-ray diffraction patterns to crystal structures, but a reading of the annual reports leaves little doubt that the division's work was becoming more basic. Thus, in 1955 a program began on the crystal structure of the orthophosphates because of their importance in bone, teeth, detergents, and fertilizers, and later this program expanded to the structure of borates. Crystal-structure determination was a capability that was to lead to considerable important work in the division.

---

<sup>183</sup> Annual Report, 1957: 58.

The determination of equilibrium diagrams has been mentioned already in this review, particularly under cement and glass studies, but like crystal structure determination, this was an autonomous activity carried out for its own value. Thus, for example, because of their possible importance in jet engines and rocket motors, ternary equilibrium diagrams for an extensive group of oxides were determined. And, because knowledge of them is crucial in nuclear reactor fuel, binary equilibrium diagrams of uranium oxide with alumina, beryllia, magnesia, and silica were determined. Again, similar work would extend well into the future.

Unreported in the Annual Report, and probably little known to management, some "bootlegged" work carried out by Alvin Van Valkenberg and Charles E. Weir would, in a few years, lead to the so-called diamond-anvil cell and revolutionize the attainment and measurement of very high pressure.

### BUILDING TECHNOLOGY

Despite the fact that the Bureau had been involved in the technology of building and housing from its earliest days, it was not until 1921 that the activity was formalized as the Building and Housing Division. In that year, Herbert Hoover, newly appointed as secretary of commerce, and with a desire to "stimulate the building industry as a means of promoting industrial recovery after World War I," formed a Division of Building and Housing in his office, along with divisions of Simplified Practice, Specifications, and Trade Standards.<sup>184</sup> A parallel division structure was formed at the Bureau, but these two divisions had no sections. The technical work was carried out in other divisions of the Bureau. This organizational situation led to some dismay on the part of Director Stratton since the direction of these new divisions was "centered in the Commerce building downtown."<sup>185</sup>

The functions of the new Building and Housing Division were less than completely technical, being "to coordinate scientific, technical, and economic research in building; to simplify and standardize building materials; and to revise state and municipal building codes."<sup>186</sup> It was not until 1930 that the division identified sections, but it soon fell prey to the Great Depression in the early 1930s and its staff dropped from thirty-six to two. But in 1937, with a special authorization from Congress, a program on low-cost housing research was initiated. No new division was created; the work was carried out in existing divisions. Then, in 1947, by combining "smaller organizational units devoted to structural engineering; fire research; heat transfer and mechanical systems; wall, floor, and roof coverings; and codes and standards" from other Bureau divisions, the Building Technology Division was finally formed.<sup>187</sup>

---

<sup>184</sup> Paul R. Achenbach, *Building Research at the National Bureau of Standards*. Natl. Bur. Stand. (U.S.) Building Science Series O; October 1970: iii.

<sup>185</sup> MFP, 233; the two NBS divisions were Building and Housing and Simplified Commercial Practices.

<sup>186</sup> Achenbach, *Building Research*: 6.

<sup>187</sup> Annual Report, 1938: 90; Achenbach, *Building Research*: 7.

This was the division found by the Kelly Committee in 1953. Its five sections: Structural Engineering; Fire Protection; Heating and Air Conditioning; Floor, Roof, and Wall Coverings; and Codes and Specifications were concerned either with building systems or the associated codes and specifications. With 102 on its staff (57 professionals), it was of moderate size, and 50 percent of its funds was from other agencies.

While the committee recognized that building research was, for good historical reasons, less complex than more traditional scientific research, and that the division's publications were valuable, it was nevertheless critical of the division. On the positive side, the committee wrote:

Many of the techniques and practices in this industry have not had the benefit of technical innovation to the degree common to our major manufacturing industries; the work going on in the Building Technology Division must be viewed in light of this historical situation. If it were compared with the complex procedures and delicate judgments found in some of the other scientific areas, it might be considered as a lower order of endeavor. But measured by the existing demand from and the degree of technical progress of the industry it serves, it is performing reasonably well.

The committee continued, "The publications of this Division, which are the record of their accomplishments, are among the most highly valued of the Bureau. The handbooks on Building Technology are . . . in constant demand."

"Nevertheless," the committee wrote "this activity requires an infusion of new blood. At present a relative handful of experienced and recognized persons are carrying the Division. These men lack competent understudies and little is being done to obtain and train them." And the committee continued, "This lack of potential leaders with competence and imagination is also reflected in many of the projects. Although much of the work is reliable and carefully done, it is performed in conventional ways and lacks the spark of imagination and enthusiasm."<sup>188</sup> As with other divisions, the committee went on to recommend that service testing be minimized and that research be increased.

In describing the actual work carried out, we depart somewhat from the section organization and discuss the program under the categories of structural engineering; heating, ventilation, and air conditioning; roofing and floors; materials; and fire.

The structural research was primarily concerned with concrete. With the participation of guest workers from the American Iron and Steel Institute, division scientists were able to relate crack formation in concrete to the design of reinforcing bars and the strength of the bond between the concrete and the steel. This work led to the development of the first standard for the deformation of reinforcing bars. Notably, the division participated in the design and material selection for the Distant Early Warning (DEW) arctic radar network planned to provide warning of a polar missile attack.

The properties of concrete are normally determined in static tests, but for some purposes, such as blast and earthquake resistance, properties under dynamic loading

---

<sup>188</sup> Kelly Committee Report: 59-60.

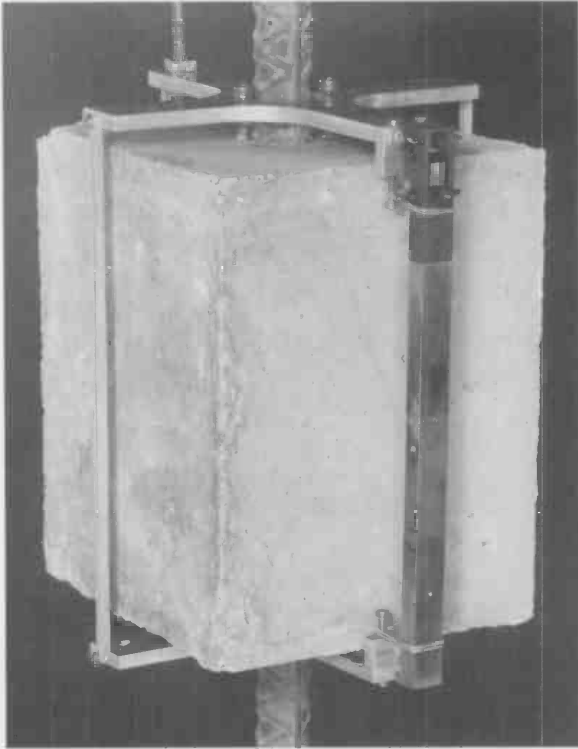

Tensile bond specimen under test at NBS. Cracks were narrower at the surface of the steel reinforcing bar than at the outside surface of the concrete, thus exposing less of the bar to atmospheric corrosion and consequent weakening than heretofore believed.

are important. A program supported by the U.S. Navy was designed to determine properties of concrete under various rates of loading, and this was accomplished at rates of  $10^{-6}$  in/s to 10 in/s. Stress-strain curves were obtained, and it was shown that both the strength and Young's modulus increased as the loading rate increased. This was a fortunate outcome in that the common static tests led to an over-design.

Other concrete studies were concerned with so-called "foamed" concrete, which contained entrained air bubbles and, in some cases, was lighter than water. Such concrete was found suitable for two-story structures.

In 1940, the division had constructed a complete four-room research bungalow for testing various building systems and components. It was thus well placed when in 1950 it began a program with the Housing and Home Finance Agency (HHFA). Designed to help establish performance-based standards for homes that the HHFA insured, or where they guaranteed loans, this program was concerned in the period with heating devices for small homes. Warm-air furnaces, radiant glass panels, and ceiling panels were studied. Making measurements of vertical and horizontal temperature distributions, heat loss and noise, the systems were compared on the basis of cost and comfort. All in all, the warm-air furnace was the best. In the course of the work it was found that the generally used heat transfer coefficients were too high by 50 percent, and this was pointed out in publications.



Underground shelter used by NBS in experiments on heat transfer from man-made caves to the surrounding earth. Heat was supplied through the ventilating system and from space heaters on the floor. To measure the temperature at various points, thermocouples were suspended in the air, ceiling, and floor, and placed at intervals up to twelve feet deep in the rock surrounding the chamber.

Other work on heating did not involve houses. One project was concerned with the heating and air conditioning of underground structures—chambers for general use, reservoirs for collecting waste heat from air conditioning systems, shafts and tunnels used for ventilation, and shelters in the event of an atomic bomb attack. In all cases the object was to measure heat transfer into the surrounding rock. Both experimental and analytical approaches were taken.

But perhaps the most unusual project did not involve housing at all, but rather refrigerated trailer trucks. In general operation, ice was found to form due to condensation of moisture in the insulated space of the truck walls, and this increased the heat transfer between inside and outside. The Bureau studied this problem and operated a trailer for 72 days at typical Washington summertime temperatures. They found that a large amount of ice (850 pounds) was formed, but the heat transfer rate was increased by a modest 8 percent. In the process of the investigation, the Bureau developed a device that could record any changes in heat transfer, and the trucking

industry and the Bureau promptly initiated a project to develop this device and to determine test conditions for rating trailers as to their insulation efficiency.

Associated with heating is the problem of air infiltration into a house. Procedures to measure this air flow were developed using coulometric techniques, pressure difference methods, and tracer gas measurements that utilized helium, ethane, or methane. Of these three methods, tracer gas measurements proved to be the best. In the course of the work, the Bureau developed a heated-thermocouple anemometer to measure air flow, which proved to be an accurate and sensitive instrument.

In a project carried out for the General Services Administration, the division tested a number of air cleaners so that Government specifications could be revised. Five electrostatic cleaners, two automatic oil-type filters, and three throw-away or cleanable filters were tested. Like many prosaic studies, these led to the development of widely adopted Government and industry-wide standards and material specifications.

The thermal insulating capacity of walls, floors, and roofs is clearly an important property of building structures, and building research at the Bureau had been long concerned with measuring this property. When a construction contains an air space, measurement is complicated because the insulating capability depends on the direction of heat flow, and large-size specimens have to be tested because of edge and three-dimensional effects. In order to determine the directional effect, the Bureau built an apparatus so that the heat flow in 5 ft × 8 ft panels with air spaces could be measured in different directions: horizontally, vertically up, vertically down, and with different slopes. Air spaces with different emissivities, for example, as provided by dark paints or reflective surfaces, were tested. Total radiative emissivity was measured, thermal conductance obtained for different emissivities, and a general relationship correlating the different variables was obtained.

This work led to the evaluation of aluminum foil reflective insulation. In projects sponsored by the Aluminum Company of America, often utilizing industrial guest workers, the insulating properties of aluminum foil were assessed by testing 154 different specimens, leading to the testing of fibrous insulation with an aluminum foil surface. It is probable that the measurement techniques developed in this work were partially responsible for the wide acceptance of glass wool insulation with aluminum foil-paper surface.

In two other projects, the effect of moisture on the thermal conductance of insulated panels was studied—one evaluated the insulation of refrigerated structures, and one investigated special situations. In work supported by the U.S. Army Quartermaster Corps, an apparatus was built to test the effect of moisture on 4 ft × 8 ft panels, and in another project, supported by the Office of the Army Chief of Engineers, the effect of moisture on the insulating properties of concrete deck roofs was studied. In the latter project, the straightforward technique of exposing fifteen samples of different roofs to simulated climatic conditions was taken, indicating that moisture can have an important effect on the insulating effectiveness of these roofs.

The Asphalt Roofing Industry Bureau (ARIB) had maintained a research associate at the Bureau since 1926, and in the 1950s most of the work done in roofing was concerned with asphalt roofs. The aim of the work was to get at the mechanism of



weathering, and a well-designed investigation lasting the whole period was carried out for about twenty foreign and domestic asphalts. Using both natural exposure and simulated weathering carried out in the laboratories, two approaches were tried. In one of them, the change in composition of the asphalt while weathering was determined, and in the other, the degradation products were collected and identification attempted. In such a complicated chemical system as asphalt, analysis of the composition at the individual chemical species level was too difficult. Therefore a chromatographic method to separate the asphalt into four distinct groups of components was developed. Then, measuring the change in these component groups during weathering gave some indication of the changes brought about by the resulting degradation. Moreover, such a system permitted the comparison of different asphalts by observing the distribution in each of the four component groups. It also provided a means of comparing degradation brought about by the combined effect of heat, light, and moisture as occurs during weathering with the effect of one of these variables alone. Such studies were carried out throughout the whole period. And with respect to the collection and identification of degradation products, a collection method was developed, but methods of quantitative identification were still being sought by the end of the period.

Analysis of asphalt degradation was not the only project carried out on roofing. At the request of the Office of the Army Chief of Engineers and the U.S. Navy Bureau of Yards and Docks, the division studied roofing conditions in army and navy stations in the continental United States, Hawaii, and Guam. As a result of these field investigations, and of prior knowledge, the Bureau wrote a well-received publication called the *Roof Maintenance Manual*. And in other work for the Department of Defense, asphalt and coal-tar roofs in the Eastern, Western, and Midwestern states were investigated. On the basis of this investigation and on tests on fourteen samples submitted by manufacturers, a proposed purchase specification for specific types of asphalt roofs was prepared.

Finally, in the study of floors, only a perfectly routine project was carried out. At the request of the army, the effects of grease, oil, acid, alkali, and bleach were evaluated on floors of various composition. After soaking the floor material overnight in the chemical to be assessed, a scratch was made on the floor covering, and its width measured. This gave a rating for the floor material. The meaning of such a test is not discussed.

The materials work of the division consisted of evaluating proprietary products for specific purposes. For other Government agencies, various materials were evaluated for their water-vapor permeability: bituminous coating for the navy, interior paints used as barrier materials for the HHFA, and various materials used to control condensation in crawl spaces in basementless homes for the Department of Agriculture. All this work was pure testing, as was the evaluation of various commercial asphalt stabilizers. Carried out in cooperation with the Asphalt Roofing Industry Bureau, these materials were evaluated with a tentative specification proposed by that organization and the Bureau. A more extensive project was carried out for the army on protective coatings for exterior masonry walls. This involved laboratory tests as well as field

inspections to installations over much of the United States and discussion of problems with builders and distributors. The main conclusion was that "proprietary portland cement paints and paints made on the job from portland cement . . . give protection from leakage caused by wind-driven rain,"<sup>189</sup> a result reminiscent of the Aquella affair.

Fire research was one of the most important programs in the Building Technology Division. Conducted in the Fire Protection Section in the fifties, this program would in later years become a division in its own right. While some of the program was concerned with testing, as in 1950 when twenty-one prototypes of building constructions—load-bearing walls, partitions, floors, and roofing—were tested to develop performance data leading to code acceptable designs, most of the program was devoted to the development of flammability test methods, to the detection of fires, and to more general fire research.

One concern was for a small-scale test that would measure the rate of spread of flame on the surface of a test sample and correlate it with flame spread along walls, ceilings and compartments. In this method, the test sample was placed vertically in front of a refractory panel heated to 670 °C, and ignition was induced to take place at the top of the sample. The rate of flame spread downward was measured and this, combined with the rate of heat release, gave a flame spread index. This index seemed to correlate with British data on actual burn-out tests in rooms. This test method has been widely used as a standard method to rate the flame spread properties of interior finished materials.

Another test method, developed for the U.S. Coast Guard, involved hand-held fire extinguishers. The problem was to define standard small fires and typical conditions that could allow establishment of a relative merit rating for extinguishers used to control flammable liquid fires that might occur on small boats. It was found that three liquid fires of increasing severity could provide a qualitative ranking of extinguishers since rather wide variations in the ambient conditions did not greatly influence the results. The work demonstrated the difference in performance among vaporizing liquid, foam, and dry chemical extinguishers in typical motorboat fires.

Some of the research projects involved only the methodology of fire research, while others were more akin to traditional physico-chemical research. An example of the former was a study of the hazard to mattresses of cigarette ignition. It was known that, under certain conditions, cigarettes ignite mattresses, leading to dangerous, smoldering fires. In a study sponsored by the Veteran's Administration, it was found that sheets and pillow slips by themselves were not a problem, and that the smoldering of cotton mattresses could be substantially reduced by treatment with fire retardant. It was not necessary to treat the whole mattress, but only its outer surface to a depth of about one inch.

Another problem studied by fire research methods was the self-ignition of fibrous materials. After determining that "a significant portion of the fires which occur in the United States each year are attributable to spontaneous ignition of certain

---

<sup>189</sup> Annual Report, 1952: 49.

combustible materials,”<sup>190</sup> the Bureau developed an apparatus to explore this phenomenon. By using an adiabatic furnace that maintained the exterior temperature of a fibrous mass the same as the rising interior temperature all the way to the ignition temperature—a sort of positive feedback system—the occurrence of self-ignition could be related to the thermal properties of the material and the temperature of the surroundings. Recommendations for storage and shipping conditions were made for a wide variety of materials.

Perhaps the most important basic research problem was studied by more traditional considerations and got down to some of the critical problems in fire science. This was a study of the mechanism of fire extinguishment by dry-powder extinguishers. First, it became apparent that to increase the efficiency of such extinguishers, it was necessary to ensure the “dispersibility” of the powder, and this was a “function of particle size and shape and the tendency of particles to agglomerate.”<sup>191</sup> But this was hardly the mechanism of extinguishment. The hypothesis that the active agent was carbon dioxide from the powder was rejected because, while most commercial powders were indeed sodium bicarbonate, others were not. Also rejected was the hypothesis that the effect was caused by radiation shielding of the fuel from the flame. But the conclusion reached was that “the behavior of the dry powders in experimental tests further suggests that the interruption of chain reactions in the combustion process may constitute another important factor in the effectiveness of these powders.”<sup>192</sup> Further research at the Bureau and elsewhere was to show that this was the correct conclusion.

On June 30, 1953, the Congress passed what was to become the first of two flammable fabrics acts.<sup>193</sup> As explained by Director Astin in a letter to George M. Wheatly of the American Standards Association (now the American National Standards Institute, ANSI) on August 29, 1952, several years previously, “following a number of fatal accidents to small children wearing highly flammable ‘cowboy suits,’ the Bureau initiated a study of such materials and still has a group working on the flammability of fabrics.”<sup>194</sup> Later, highly flammable “torch sweaters” and very light silk scarves also caused serious injury. This led the Congress to pass the 1953 law which set a mandatory standard whereby fabrics that burned more rapidly than a specified rate when measured on a simple jig largely developed by the Bureau could not be sold in interstate commerce. While this law solved the problem for such incendiary fabrics, it did not solve the whole fabric flammability problem and, as will be detailed later, a second flammable fabrics act was passed in 1967. For several years this latter act gave the Bureau regulatory responsibility for the first time in its history.<sup>195</sup>

---

<sup>190</sup> Annual Report, 1953-1954: 71.

<sup>191</sup> Annual Report, 1957: 66.

<sup>192</sup> Annual Report, 1956: 73.

<sup>193</sup> *Flammable Fabrics Act, U.S. Statutes at Large*, 67 (1953): 111.

<sup>194</sup> Letter, A. V. Astin to G. M. Wheatly, 29 August 1952. (NARA; RG 167; Director's Files; Box 23; Folder 10.0 1952)

<sup>195</sup> *AN ACT To amend the Flammable Fabrics Act to increase the protection afforded consumers against injurious flammable fabrics, U.S. Statutes at Large*, 81 (1967): 568.

From this short description, the applied and often prosaic nature of the work which bothered the Kelly Committee is evident. Much of this nature was determined by the mandates of the non-Bureau sponsors, and the Bureau staff were well aware of the need and importance of broader-based research. This awareness was shared by division management, which were also aware of the need for the infusion of new blood.<sup>196</sup> In future years the division's research situation would change substantially.

#### APPLIED MATHEMATICS AND COMPUTERS

In mid-1947, less than two years after Edward Condon became director of the Bureau, he formed two new divisions: Atomic and Radiation Physics, and the National Applied Mathematics Laboratories (NAML). If the first of these brought the "new physics" to the Bureau, the second may be said to have brought the "new mathematics" of electronic computation. Formed with the considerable help of the U.S. Navy, other military agencies, and the Census Bureau, the new division was renamed simply Applied Mathematics in 1954 when its original name was thought to be too grandiose. It was originally conceived of as a laboratory that would be equipped with high-speed computing machinery, lead in the development of such machinery, and serve as a central computation facility for the Government. Later, research and training functions were included, so that at the time of its formation, the division-laboratory, under the directorship of John H. Curtiss, consisted of four units: Numerical Analysis, which consisted of the Institute for Numerical Analysis on the UCLA campus with responsibility for research and training in numerical analysis, and a complementary unit in Washington; a Computation Laboratory equipped with large-scale computing equipment to carry out computing for NBS staff and other Government agencies; a Statistical Engineering Laboratory devoted to research in statistical methods and providing consultation and cooperation in statistics; and a Machine Development Laboratory with the function of developing and constructing new electronic computers.<sup>197</sup> The whole operation was overseen by an advisory committee of experts outside the Bureau called the Applied Mathematics Executive (later Advisory) Council. At the time the Kelly Committee carried out its evaluation of the division, there was also an Electronic Computers Section in the Electronics Division, where all the computer construction and research on components was carried out.

NAML was short-lived. In 1954, as part of the divestiture recommended by the Kelly Committee, the Electronics Division was combined with the Electricity Division, except for the Electronic Computers Section, which was elevated to division status under Samuel N. Alexander and named Data Processing Systems. The Machine Development Laboratory was transferred to the new Data Processing Systems Division. Except for the administrative separation, the Applied Mathematics and Data Processing Systems divisions together functioned as had been envisioned in the formation of the National Applied Mathematics Laboratories.

<sup>196</sup> William C. Cullen and Daniel Gross, private communication, January 1991.

<sup>197</sup> M. R. Hestenes and J. Todd. *NBS-INA—the Institute for Numerical Analysis—UCLA 1947-1954*. Natl. Inst. Stand. Technol. Special Publication 730; August 1991: 1-5.



A corner of the library at the NBS Institute for Numerical Analysis. The Institute maintained a comprehensive collection of works pertinent to applied mathematics and numerical methods.

These changes were not the last in the fifties. In mid-1953, John H. Curtiss, the first chief of the NAML, resigned, to be succeeded in 1954 by Edward W. Cannon after an acting stewardship by Franz L. Alt. In its investigation, the Kelly Committee found that most of the activities of the NAML were acceptable and followed the directives of the Bureau's Organic Act of 1950. However, the work of the INA was almost entirely supported by funds from the military, and the Kelly Committee observed that its work was more like that of a university than that of NBS. In addition, Secretary of Defense Charles Wilson had decreed that a non-DoD Government agency could not serve as administrator of projects entirely or largely supported by defense funds, and carried out at a university. Thus, on June 30, 1954, the INA was removed from the Bureau and given entirely to UCLA where it was thereafter called Numerical Analysis Research, and its move concluded the Bureau's divestiture of military work. Finally, in 1954, a new section, called Mathematical Physics, was formed.

With a staff of 159 (119 professionals) when the committee investigated it, the division was of substantial size. But its funds were only 9.3 percent from direct appropriation, the remainder coming primarily from the military, and more than half the funds were expended in general services. Despite this, the committee made no

recommendation for divestiture, recognizing that the work of the division was of general applicability, not solely devoted to specialized work as was the case with the ordnance divisions. Moreover, the division provided a valuable consulting service to non-military agencies, and was the principal advisor to the Census Bureau on computer problems. It was a healthy and productive division with high morale doing excellent work.

The section structure of the Applied Mathematics Division, along with the work carried out in the Electronic Computers Section of the Electronics Division, and subsequently in the Data Processing Systems Division, forms a good basis for a synopsis of the technical work carried out.

As now seems perfectly natural considering the history of machine computation, three problems were of constant concern throughout the whole period: the solution of sets of simultaneous linear equations, eigenvalue problems, and the numerical solution of ordinary and partial differential equations. Given the first problem, constant attention was given to matrix inversion, which in 1952 was called "the basic problem of numerical mathematics."<sup>198</sup> The object here was to develop useful codes and methods of general utility in the numerical calculation of the inverse matrix. In this development, such topics as the stability of solutions and the effect of round-off errors had to be investigated. Similar considerations drove the work on eigenvalue problems, and by 1956 general-purpose codes for eigenvalues and eigenvectors were "brought to a high state of perfection and put on a routine basis."<sup>199</sup> Related to these matrix problems and originating from operations-research-related activities, was the development of an existence theory of the solutions of linear inequalities.

The numerical solution of ordinary differential equations proceeded. Partial differential equations were, of course, much more complicated, especially considering that SEAC, on the Washington, D.C. campus, and SWAC (Standards Western Automatic Computer) at the INA at UCLA, while state-of-the art at the time, were, by modern standards, primitive instruments. Nevertheless such problems as the vibration of a square plate were undertaken with satisfactory results.

An outcome of these research efforts was new conjectures which could be checked, and methods of attack on old, but unproven, conjectures. In short, the studies led to some enjoyable mathematics. An example was the proof that  $2^{1279}-1$  is a prime number—the largest found as of that date. Determining the primality, and finding the prime factors of such large numbers, was to be an important problem in the future in connection with so-called trap-door codes. The listing of a few other problems gives a further flavor of the work.

- The development and testing of a method for generating random numbers to be used in Monte Carlo methods of numerical solutions.
- Instruction codes for SEAC for the numerical evaluation of integrals where great accuracy was essential.

---

<sup>198</sup> Annual Report, 1952: 51.

<sup>199</sup> Annual Report, 1956: 76.

- The theoretical analysis of a war-games model represented by six non-linear differential equations.
- The development of rational approximations to special functions to make them available by computation on high-speed computers.

The Computation Laboratory calculated tables of special functions, carried out computations for other agencies and Bureau staff members in cooperative endeavors that sometimes turned into full-scale research problems, and trained the first generation of Bureau programmers. And, as did the Institute for Numerical Analysis, it created new theories in numerical analysis for application to high-speed computers.

The calculation of mathematical tables was, in a sense, a carryover from the prewar WPA Mathematical Tables Project operated by the Bureau. But the availability of high-speed computers raised the question about the necessity for these tables which were, after all, calculated on such machines. Concerned about this problem, the National Science Foundation and the Massachusetts Institute of Technology convened a meeting in 1954 to discuss the need for mathematical tables. The consensus was that such tables were necessary because "a greater variety of functions and higher accuracy of tabulations are now required as a result of scientific advances." Indeed, the availability of computers increased the tables' importance because they could serve in "preliminary surveys" of a problem before undertaking the tedium of programming, and many-place tables of important functions were invaluable for checking the accuracy of subroutines. And, of course, they were essential for those without computers. As a result of this conference, the NSF requested that the Bureau prepare a handbook containing the more common functions, a plan which had already been considered by Milton Abramowitz of the Computation Laboratory. A massive undertaking, this book of more than 1000 pages was published in 1964.<sup>200</sup> With the decisions of this conference in hand, the Computation Laboratory continued the calculations of mathematical tables through 1972.

The other main activity of the section was consultation and cooperation with Bureau staff and other agencies in carrying out calculations. This led to some interesting problems:

- Calculating the trajectory of various missiles.
- Studies of explosions.
- The calculation of LORAN (Long Range Navigation) tables.
- The solution of four nonlinear differential equations arising from a study carried out at the Naval Medical Center on the reaction of nerve fibers to electrical stimuli.

---

<sup>200</sup> Milton Abramowitz and Irene A. Stegun. *Handbook of Mathematical Functions With Formulas, Graphs, and Mathematical Tables*. Natl. Bur. Stand. (U.S.) Applied Mathematics Series 55; June 1964. From 1964 through 1972 this handbook went through ten printings. Each iteration corrected, revised, or modified the previous work. In the preface to the ninth printing, Lewis Branscomb noted that after only four and one-half years the 100 000th copy of the handbook was presented to Lee A. DuBridge, science advisor to the President. At the end of 1970, distribution of the handbook approached 150 000.

Computations were not limited to strictly scientific problems. Many operations research calculations were made, such as those needed to determine the optimum deployment of aircraft to ensure a balance between combat, reserve, and training aircraft. This computation was carried under a largely classified project named SCOOP (Scientific Computation of Optimum Programs) for the Office of the Air Controller. Similarly, SEAC was used in the awarding of contracts to bidders for the New York Quartermaster Purchasing Agency.

In 1957 the Bureau obtained its first large commercial computer, the IBM 704. Industry had caught and surpassed the Bureau in the construction of computers. In conjunction with SEAC, it was used to perform scientific calculations and data processing programs, including the Bureau payroll.

One of Condon's reasons for an applied mathematics effort at the Bureau was to be sure that sound statistical principles were used in the Bureau's research and testing activities. To this end he brought to the Bureau mathematician/statistician John H. Curtiss from the navy where he had successfully applied statistical theory to problems of naval engineering, and appointed him statistical assistant to the director. But before Curtiss could organize a statistics group, Condon turned over to him the administration of the Bureau's responsibilities in the development of computers and numerical analysis. Hence, still needing a leader of a statistics effort, on October 1, 1946, Condon brought in Churchill Eisenhart from the University of Wisconsin to head up a small statistical group in Curtiss' office. Eisenhart became the chief of the Statistical Engineering Laboratory at its founding in 1947, and remained so until 1963. With its stated function, the work of the section led to close collaborations with the Bureau staff and outside agencies. These collaborations extended from short consultations to full-scale research projects that lasted for months. An example of the type of services it provided was its role in the "suicide test" in the AD-X2 affair, where the section designed the experiment and provided the final statistical analysis of the results. Along with this service function went research, for without research the staff would soon lose its scientific edge.

Throughout the whole period, the two main topics studied were the statistical design of experiments and the analysis of experimental data. The aim of proper experimental design is to obtain the maximum amount of information with a minimum amount of effort. Generally used in agriculture and industry, the principal effort throughout the period was to adapt these methods to scientific research. There are many examples of the value of these designs, the AD-X2 case being only one. Others, culled from a long list, included experimental designs for the intercomparison of four national radium standards to arrive at a consensus of the standards used; the study of the dependence of fatigue life of ball bearings on load, where the failure rate is very low and many tests do not extend to failure, thus requiring the development of new analytical methods; and work in the development of methods for the high-precision measurement of temperature. While all this consultation was going on, research was carried out on different types of experimental designs, but it did not end there. Extreme value theory—particularly valuable in writing building and engineering codes—was a continuing activity, as was the study of distribution-free methods, where no assumption





Churchill Eisenhart came to the Bureau in 1946 where he introduced modern statistical methods, particularly methods of experimental design. He founded the Statistical Engineering Laboratory in 1947, which he headed until 1963 when he became a senior research fellow until his retirement in 1983. A recognized authority on the use of statistics in research and manufacturing, one of his papers led to the name "Eisenhart's Model II" for the random effects model.

of the experimental results is made. The section clearly carried out Condon's original expectation on the desirability of applying statistical methods in the Bureau's research.

By 1955 the work of the Bureau entailed so much computation on mathematical physics and engineering problems that a new section, called Mathematical Physics, was formed to carry out research in mathematical analysis related to topics in mathematical physics. The concentration was, however, in those areas where the Bureau had interests, and these were fluid mechanics, mathematical elasticity, and electromagnetic and acoustical diffraction theory. As part of its research, the section published tables of 800 Fourier transforms as its contribution to the mathematical tables project. Some of the specific projects carried out were the analysis of the fundamental basis of two-phase vapor-liquid condensation systems; the calculation, using SEAC, of the stresses and displacements in a corrugated diaphragm; the computation, again using SEAC, of the vibrations of a delta wing, then of great interest for supersonic aircraft; and the analysis of wave transmission through geophysical models, which was expected to contribute to the study of earthquakes by seismographic methods.

Beginning in 1950, when SEAC became operational, it was the computer available for calculations in Washington, and in 1951 SWAC became available to the INA in California. The sections mentioned up to this point used these computers for their work, but the maintenance, operation, and continued development of these machines fell on the Electronic Computers Section of the Electronics Division

before 1954, and on the Data Processing Systems Division after its formation in 1954. In that same year the Bureau announced that data processing for the solution of business and management problems would be a major thrust.<sup>201</sup>

But SEAC and SWAC were not the only computers involved, for the Bureau continued the development and construction of new machines for the military. Two major efforts were the production of STATAC-SCOOP, a serio-parallel machine of very high speed made for very-large-scale computations for the SCOOP (Scientific Computation of Optimum Programs) program of the Office of the Air Controller. Parallel in intent was DYSEAC, a new computer built for the military. Similar to SEAC, but with a new logical design and much more powerful, it used modular construction. And while this computer building was going on, SEAC was continually upgraded with new components—various means of punched card handling, high-speed magnetic tapes, diode memories, magnetic drum memories (for SWAC), electrostatic memories, transistor switching circuits, and others, making SEAC an instrument for the development of new components.

Not only was the Data Processing Systems Division a research organization in the building of new computers and the development of new components, it was also a place where other agencies of the Government could come for advice, guidance, and consultation on computer use and procurement, with the division in some cases actually carrying out the procurement process. It was a clearing house for information on the application of computers to science, and in the processing of business data. The last point became an announced effort in 1955, and some projects showed the type of activity the Bureau had in mind. In cooperation with the navy's Bureau of Supplies and Accounts, an exploratory program to determine the applicability of electronic techniques to supply management was carried out. Involving such topics as problem definition, machine coding of supply replenishment procedures, and new methods of sorting and merger of data in master files, the study went far to point out what had to be done to create a complete electronic supply management system. Other data processing applications analysis included payroll and accounting, sorting, file maintenance, and report editing. Other computers were added or built for special purposes. A "modest" analog computer was purchased as part of the whole computation laboratory for the modeling of specialized problems and, under sponsorship by the Weather Bureau and the Atomic Energy Commission, two others were developed for prediction of fallout patterns from atomic bomb blasts. These two were shipped to Eniwetok in 1956 for use in atomic bomb tests.

---

<sup>201</sup> House Committee on Appropriations, Subcommittee on Department of Commerce and Related Agencies, *Department of Commerce and Related Agencies Appropriations for 1956: Hearings Before a Subcommittee of the Committee on Appropriations*, 84th Cong., 1st sess., National Bureau of Standards, 30 April 1955: 167. In asking for funds for a program in automatic data processing, Astin pointed out that the Bureau had been consulted by the Patent Office, Bureau of the Budget, General Accounting Office, Health, Education, and Welfare Department, Treasury Department, and "most Government agencies with management problems involving processing of large quantities of paper or routine data. The Departments come to us for advice and assistance."

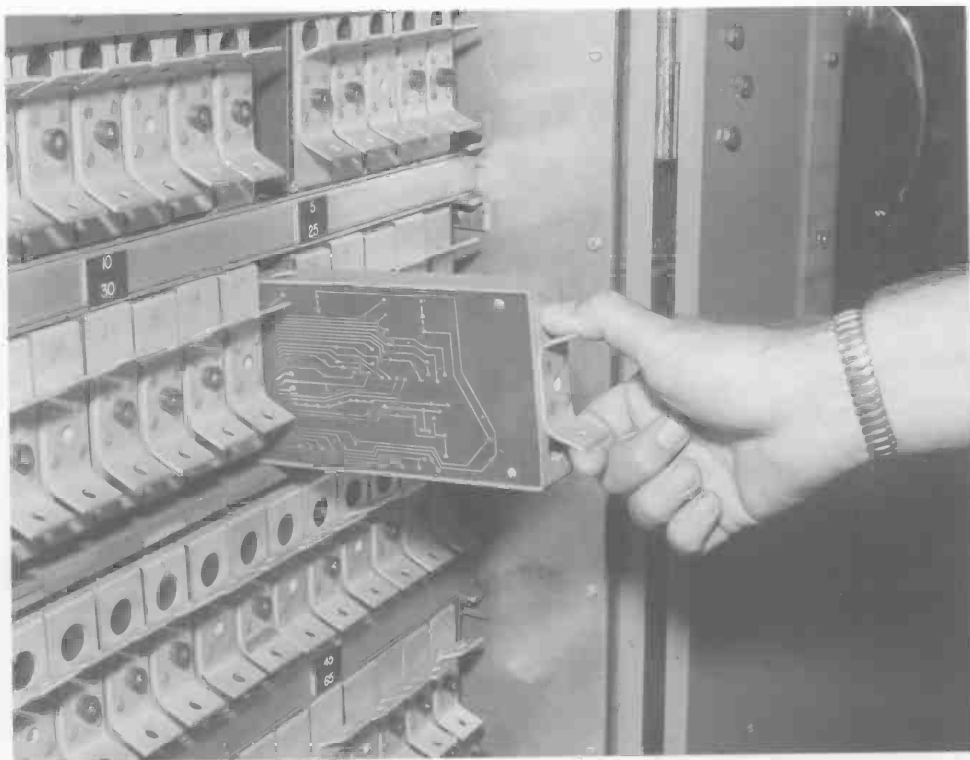

In DYSEAC, much of the computer circuitry was reduced to standardized packages. Here, an operator inserted a delay-line package which, because of the general similarity of the circuits of most stages, was one of only two types of etched circuit packages required as basic building blocks of the computer.

Considering the original aim of the National Applied Mathematics Laboratories of forming an organization that would lead in the development of high-speed electronic computers; serve as a central computation facility for the Federal Government; carry out research in numerical analysis; and serve as a source of information, guidance, and training on computers, the Bureau's applied mathematics and computer effort must be judged as highly successful. Yet the effort led to a great deal of discussion in the committee report about its appropriateness, perhaps because the whole effort did not arise directly from the core measurement-standards function of the Bureau. In large part, the applied mathematics program arose from the "advisory service to Government agencies" clause in the 1950 version of the Organic Act,<sup>202</sup> for the activity was almost wholly supported by the military agencies, at least in its early years, and with respect to the development of computers as part of this advisory function, the committee notes,

<sup>202</sup> Almost humorously, the NAML was formed before the passage of this revision of the Organic Act.

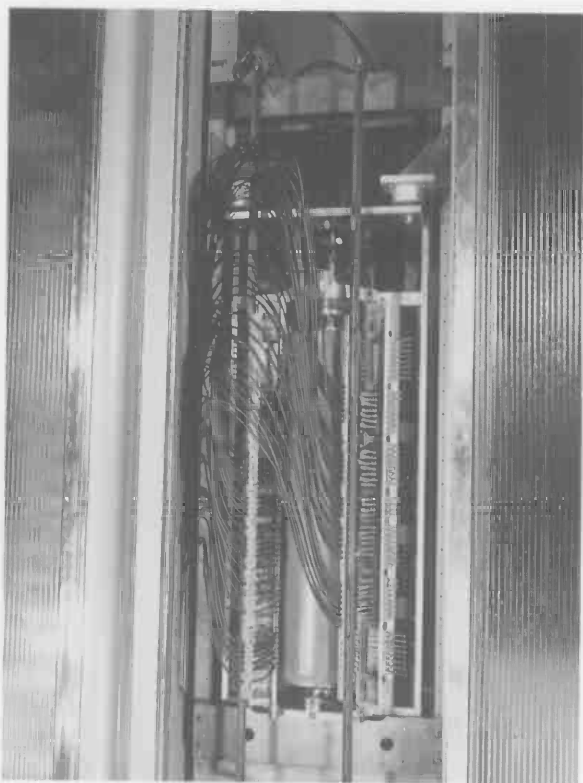

The magnetic drum auxiliary memory added to SWAC increased its problem-solving capacity.

“Computers are a rapidly developing area and no one has succeeded in producing experts except by building computers.”<sup>203</sup> The major Bureau function of the program was to help the rest of the Bureau carry out their functions—it was a staff rather than a line activity. In fact, the 1950 act specifically authorized the Bureau to “operate a laboratory of applied mathematics,” and so it did.

#### **CENTRAL RADIO PROPAGATION LABORATORY**

In its budget presentation to the House for FY 1947, the Bureau made a strange request. It asked for \$550 000 for an activity classified under “Information Services” and called “Forecasting Radio Communication.” As explained—in somewhat fractured syntax—by Director Condon in what was his first appearance before the budget committee, “This represents an activity which it is planned to consolidate, taking over from a number of Government agencies, including the Army and Navy, the Army Signal Corps, the Army Air Forces . . . the Coast Guard, the Federal Communications Commission and others, also from private industries, who have

<sup>203</sup> Kelly Committee Report: 72.



NBS computer engineer J. Howard Wright held a map on which he had marked isoentgens of predicted radioactive fallout. Values for wind speed and direction at different levels and for characteristics of the radioactive cloud were set into panel controls of the computer. The level of fallout predicted for points selected by map-table handwheels was given by the panel meter shown on the console. The oscilloscope showed the area-wide distribution of fallout.

requested that . . . this be consolidated into one bureau.”<sup>204</sup> In this first request the Bureau was asking for funds to take over a forecasting service for radio communication that had previously been funded by other agencies. During World War II, the Bureau, with funds from the military, had formed an organization called the Inter-service Radio Propagation Laboratory (IRPL), which provided “radio weather” forecasting used for frequency selection and communications planning that were crucial to the prosecution of the war. It was now felt that the effort should become primarily civilian, hence the request to Congress. Congress did not balk, and on May 1,

<sup>204</sup> House Committee on Appropriations, Subcommittee of the Committee on Appropriations, *Department of Commerce Appropriation Bill for 1947: Hearings Before the Subcommittee on Appropriations*, 79th Cong., 2d sess., National Bureau of Standards, 29 January 1946: 192.

1946, a new organization, the Central Radio Propagation Laboratory (CRPL), was formed at the Bureau. It did far more than radio weather forecasting. As explained to the Appropriations Committee a year later:

On May 1, 1946, the Central Radio Propagation Laboratory, administered by the Bureau of Standards and directed by an executive council having members from the Army, Army Air Forces, Navy, Federal Communications Commission, Civil Aeronautics Administration, Coast Guard, Bureau of Standards, Weather Bureau, and the industry as represented by the Radio Technical Planning Board began operations. This Laboratory, which was established at the request of the above-mentioned agencies, is a continuation and expansion of the Inter-Service Radio Propagation Laboratory, an organization sponsored and supported by the military services during the war. Since the organization of CRPL, the various Government agencies have concentrated basic research in radio-wave propagation in this Laboratory. Such centralization of basic work has saved considerable manpower and money by producing a well-coordinated program with a minimum of manpower."<sup>205</sup>

In forming of this new organization, the Bureau combined all its research on radio propagation and radio standards with the forecasting function, and asked for increases from the Congress for the next several years. For FY 1947, the Congress appropriated \$1.174 million, which included the \$550 000 originally requested; by 1949 the appropriation had become a line item for which the Congress appropriated \$2.56 million. That year the total appropriation for the Bureau was \$8.44 million, with the CRPL representing a full 30 percent of the Bureau's appropriated funds.<sup>206</sup> Funding requests then began to level off, and by the time of the Kelly Committee Report the appropriation for the CRPL was \$2.629 million. A staff of 414 (192 professionals) made it the largest organizational unit in the Bureau. With a total of \$990 000 in transferred funds, a full 72.6 percent of the laboratory's support was by direct appropriation, a figure much closer to what the committee considered proper, and indeed the committee found that "The Central Radio Propagation Laboratory constitutes one of the finest scientific groups in Government and its operations fall within the legitimate sphere of Federal activity."<sup>207</sup>

<sup>205</sup> House Committee on Appropriations, Subcommittee of the Committee on Appropriations. *Department of Commerce Appropriation Bill for 1948: Hearings Before the Subcommittee of the Committee on Appropriations*, 80th Cong., 1st sess., National Bureau of Standards, 12 March 1947: 336. The quoted excerpt is part of testimony signed by members of the Executive Council from the Army Air Force, Navy Department, Coast Guard, Civil Aeronautics Administration, Federal Communications Commission, and Weather Bureau.

<sup>206</sup> These figures come from the House Appropriation Hearings for the appropriate years.

<sup>207</sup> Kelly Committee Report: 77. Although the committee at one point in their discussion found that the CRPL was an appropriate Bureau activity, in its formal finding the committee carefully wrote "Federal" rather than "Bureau" activity. There may have been some concern about the Bureau conducting "radio weather" research and forecasting among its functions, although it is specifically mentioned in the 1950 version of the Organic Act. Indeed, this portion of the CRPL would in due course be divested from the Bureau and become part of the newly-formed Environmental Science Services Administration (ESSA) in 1965.

At the time of its formation, J. Howard Dellinger was the CRPL chief. After Dellinger's retirement in 1948, the CRPL was reorganized and Newbern Smith was named chief. The organization found by the committee in 1953 consisted of three laboratories, each with two sections: Ionospheric Research (Upper Air Research, Ionospheric Research); Systems Research (Frequency Utilization Research, Tropospheric Propagation Research); and Measurement Standards (High Frequency Standards, Microwave Standards). A special section provided current analyses of radio propagation data, issued working predictions of radio propagation, and carried out research on improvement of predictions. Upon movement of the CRPL to Boulder in 1954, the three laboratories were accorded division status and their names were changed to Radio Propagation Physics, Radio Propagation Engineering, and Radio Standards.<sup>208</sup>

In addition to the work carried out in Washington or Boulder, the laboratory operated a number of field stations, some with Bureau personnel and some under contract with outside organizations. At the time of the committee report there were ten Bureau-operated stations<sup>209</sup> and seven under contract. The Laboratory also operated the Bureau's time and frequency broadcast stations—WWV in Beltsville, Maryland, and WWVH on Maui. It was a far-flung laboratory.

The laboratory had a significant participation in the 1957–1958 International Geophysical Year, as well as its in-house activities.

Since the two principal concerns of the CRPL were radio propagation and national primary standards at radio frequencies, it had a varied program in radio wave propagation physics, geophysics associated with radio propagation, precise measurement techniques for electrical quantities at radio frequencies, and primary frequency standards. This last line of research led the laboratory to the development of the "atomic clock."<sup>210</sup>

Because of the immense postwar explosion of radio communication led by FM broadcasting and television, there was inordinate pressure for space in the frequency spectrum, particularly in the VHF and UHF frequency ranges.<sup>211</sup> And because frequency allocations could not be made until the propagation characteristics of the different frequencies were known, a great deal of the work of the laboratory was aimed at obtaining that information. A listing of the projects undertaken gives a flavor of the type of work carried out.

---

<sup>208</sup> Wilbert F. Snyder and Charles L. Bragaw, *Achievement in Radio: Seventy Years of Radio Science, Technology, Standards, and Measurement at the National Bureau of Standards*. Natl. Bur. Stand. (U.S.) Special Publication 555; October 1986. Appendix C: 762-763.

<sup>209</sup> These were located at Fort Belvoir, Virginia; Sterling, Virginia, on the site of what is now Dulles Airport; Cheyenne Mountain, near Colorado Springs; Maui; Guam; Puerto Rico; Panama Canal Zone; Anchorage, Alaska; Point Barrow, Alaska; and Greenland. The number of such stations changed from time to time.

<sup>210</sup> "NBS Research in Radio Propagation," *Technical News Bulletin*, 38 (April 1954): 49-58. An excellent general summary of the work of the CRPL is given in this report.

<sup>211</sup> These acronyms stand for Very High Frequencies and Ultra High Frequencies, respectively, and their ranges are 30 MHz to 300 MHz and 300 MHz to 3000 MHz. For comparison, the FM broadcast band covers the VHF range 88 MHz to 108 MHz.

- There was considerable study of the effect of the terrain on propagation, finding, among other things, that in the VHF region, the configuration of the terrain was important in determining the directivity of directional antennas.
- Since the ionosphere is of central importance in radio propagation, there was a constant study of the ionosphere.<sup>212</sup> For example, it was found that storms with well-defined centers in the ionosphere moved across the continent, sometimes at speeds of up to 300 km/h. Because propagation by reflection from the ionosphere at oblique incidence is possible at higher frequencies, this effect was studied both theoretically and experimentally.
- A theory of tides in the earth's atmosphere was developed. The concern was with the relative importance of gravitational and thermal effects. The theory predicted that the thermal effects should exceed the gravitational by a factor of 100, and experimental verification of this prediction upset long-held beliefs.

Perhaps the most important developments in the period had to do with the VHF and UHF propagation beyond the horizon. Since such propagation is generally "line of sight," propagation beyond the horizon should not occur. However, under certain conditions, it does occur due to scattering either from the troposphere or from the ionosphere. This is called "forward scatter propagation," and was believed to be caused in the troposphere by scattering from "very small inhomogeneities in the refractive index of the atmosphere."<sup>213</sup> The demonstration of reliable propagation by this tropospheric scatter led to its adoption by industry and the armed forces, thereby eliminating some relay stations. Ionospheric forward scatter occurs from the lower portion of the ionosphere, and is particularly useful in the polar regions. Thus, a communication system from Labrador to Greenland was designed by the Bureau and built under its supervision for the United States Air Force. The system worked so well that it was extended to England via Iceland, thus providing complete transatlantic communication by ionospheric forward scatter. Clearly, the study of the ionosphere and its movements is essential in utilizing this mode of communication.

The ultimate limitation on radio communication results from noise, and this led to an international effort on noise maps and noise prediction, guided by the International Radio Consultative Committee (CCIR). Illustrating the type of interaction the laboratory had with this international effort, it worked with a representative from the British Department of Scientific and Industrial Research who came to Boulder to help develop new methods of presentation of maps and predictions.

The study of radio noise and its origins was an important part of the CRPL research program throughout the whole period. Radio noise has two sources: terrestrial and extraterrestrial, or "cosmic." The former determines the ultimate limit to radio

---

<sup>212</sup> This is the region of the atmosphere that extends from approximately 50 miles to 300 miles, and contains many charged particles. The region below the ionosphere, which does not contain charged particles, is called the troposphere.

<sup>213</sup> Annual Report, 1955: 109.





This field station established near Boulder, Colorado, to monitor signals transmitted by radio stations WWV and WWVH, was also used as one of a network of ionospheric probing stations maintained by or operated in cooperation with NBS. The C3 ionosphere recorder (right, background) was one of the instruments used widely by science and the military for investigating the outer atmosphere by radar techniques.

reception below about 30 MHz, and its main natural cause is thunderstorms—hence it is called atmospheric noise although much of it is man-made. Indeed, a hunt to find a location where man-made sources were minimized led to a site near Bill, Wyoming. The study of cosmic noise automatically led the laboratory into radio astronomy, particularly of the sun, which is the main source of radio noise from outer space and whose 11-year sunspot cycle has major effects on the earth's ionosphere.

Standards and measurement methods are principal needs in the study of terrestrial noise. To provide such methods the Bureau developed a receiver that automatically recorded noise levels at eight frequencies between 50 kHz and 20 MHz. This receiver-recorder was used to make a detailed statistical study of the amplitude and time distribution of atmospheric noise to permit an accurate evaluation of the errors that this source of noise produced in various radio systems. It was found that the average noise voltage, the average logarithm of the noise voltage, and the frequency

“provide a reasonably comprehensive picture of the physical nature of its amplitude distribution.”<sup>214</sup> This noise receiver was internationally adopted for noise measurements and, in 1956, fourteen were under construction for placement around the globe for the International Geophysical Year in 1957–58. At higher frequencies, noise of extraterrestrial origin becomes important. Indeed, in the words of the 1950 Annual Report, “Cosmic and solar radio waves reaching the earth from outer space are manifested audibly as frying and hissing noises in a receiver at the higher frequencies.” Study of this noise led the CRPL into a program on radio astronomy, where the main interest was the sun. In work that was partly observational and partly theoretical, recordings were made of both background noise from the sun and noise in sudden bursts, with special detailed studies of small bursts of noise. These studies gave information on the breadth of the spectrum of outbursts, and on the “basic nature of the processes taking place in the sun.”<sup>215</sup>

This observational work was backed up by a theoretical effort in which two models were investigated. The first was of oscillations in a plasma, and the second was shock waves being propagated in an ionized atmosphere with a superposed magnetic field. The former showed that radiation is possible from such a wave, but the period depends on the amplitude and the phase velocity, and it was felt that this explained the second-harmonic component of radio noise. The analysis of shock waves showed that in such a model there is a non-Maxwellian distribution of ions, and this helped to explain the observed anomalous dual-temperatures for the solar chromosphere. The interaction of the two waves suggested that the fine structure of solar noise might be due to plasma waves.

In 1956, after the discovery that Jupiter is a source of radio noise, its study was begun. It was possible to show that Jupiter has an ionosphere that behaves much like Earth’s with respect to the sun’s sunspot cycle. It was also possible to determine precisely the planet’s period of rotation, and to show that there is a rigid core beneath the atmosphere from which the radio noise originates.

Finally, from a study of solar flares and the associated 200 MHz emission, improved methods of forecasting magnetic disturbances were developed.

These, of course, were not the only activities carried out in the propagation portion of the CRPL. Others include the following:

- A study of the reflection of very low frequencies from the ionosphere, which gives information on the structure of the ionosphere and the propagation characteristics at these frequencies.
- The attenuation of microwaves by rainfall.
- The development of automatic field-intensity measurement equipment.
- The setting up of a chain of field-strength recording stations to study propagation in the Auroral region where propagation is difficult. North of the maximum Auroral zone, propagation takes place with high reliability, but the antenna pattern is very important.

<sup>214</sup> Annual Report, 1956: 96-97.

<sup>215</sup> Annual Report, 1950: 84-85.



Mobile research unit used by NBS to measure the field strength of radio signals. The antenna on top of the trailer could be raised to a height of 30 ft by remote control while the unit was in motion.

- A study of the enhancement of radio signals by the edges of obstacles such as the edges and tops of mountains. It was found that edge-diffraction theory is applicable to the problem.
- Theoretical studies of turbulence in the upper atmosphere and its effect on the ionosphere.
- A study of night airglow resulting from excited molecules and atoms in the region about 100 km above the earth.
- The observation on February 23, 1956, of a major solar flare that produced a worldwide increase in cosmic ray flux, along with the expected communication fade out, and that caused a large increase in ionospheric absorption in the dark hemisphere. This was the first observation of such a dark-hemisphere effect from a solar flare.
- The investigation of over-water tropospheric propagation in the Pacific Coast region.
- A study of the origin of the fading of signals reflected from the ionosphere.
- The development of methods for the calculation of both steady-state and transient propagation of the very low frequencies of 10 Kz to 100 kHz, pre-saging the day when such systems would be extensively used for military communications.
- Work for the Air Navigation Development Board in developing an air navigation system (called TACAN). The aim was to develop this into a nationwide system.

In addition to these various projects, the laboratory carried out a high-precision measurement of the speed of light, one of two made by the Bureau in the fifties.

All this work was carried out in the Radio Propagation Physics and Radio Propagation Engineering Divisions and their predecessors, but this was not all the work carried out in the CRPL. A whole division—Radio Standards—was devoted to the Bureau's central mission of providing standards, measurement methods, and calibration services in the radio field. With the explosive growth of radio communications in the post-World War II period, this was a crucially important activity. Indeed, the press for calibrations was so great that in 1956 work was begun on a new wing to the Radio Laboratory building in Boulder. Called the Electronic Calibration Center and scheduled to be completed in 1958, the new wing was the Bureau's response to the burgeoning requests for ever more calibrations. The air force and the navy's Bureau of Aeronautics alone were expected to send more than 4000 items for calibration yearly. Along with the building proper, work was under way for the design and construction of \$1 million worth of interlaboratory standards and other specialized equipment. Many of the items submitted for calibration were, in fact, themselves secondary laboratory standards to be used for calibrations in the sender's laboratory after calibration against the Bureau's national standards. It was a classical example of how the Bureau kept the Nation on a common measurement basis in a new field of technology.

The required radio standards were many and varied, and often associated with a specialized measurement method. There were standards for noise, voltage, power, impedance, radio interference measurements, attenuators, a whole class of measurements associated with wave guides, field strength, and that queen of all measurements, frequency. Research was carried out continuously to improve the standards/measurement methods and, in keeping with the thrust of technology and commercial practice, to extend the frequency range, particularly to higher frequencies because of the wider spectrum available there. To give just two examples, standards for impedance measurements were extended in 1955 to 18 GHz, or to a wavelength of approximate 1.6 cm, and in 1953, the calibration service for frequency meters was extended to 40 GHz.

The move to Boulder necessitated moving the national standard of frequency from Washington to the new site, where all the radio standards work was now located. This was accomplished in 1954. At that time the national standards were a set of quartz crystal oscillators, kept at constant temperature and jealously guarded. These standards were transferred to Boulder and placed in three separate 50 ft wells for temperature stability. Between July 7 and October 12, they were compared with WWV broadcasts from Beltsville, Maryland, and on that latter date pronounced fit. Clearly, during this moving period the oscillators that controlled WWV were the *de facto* national frequency-time standards.

But the use of quartz resonators as national frequency/time standards was not to last long. The Radio Standards Division was working on four models of an atomic clock, which would eventually replace the quartz artifact with a frequency-time standard based on an invariant and unchanging atomic phenomenon.

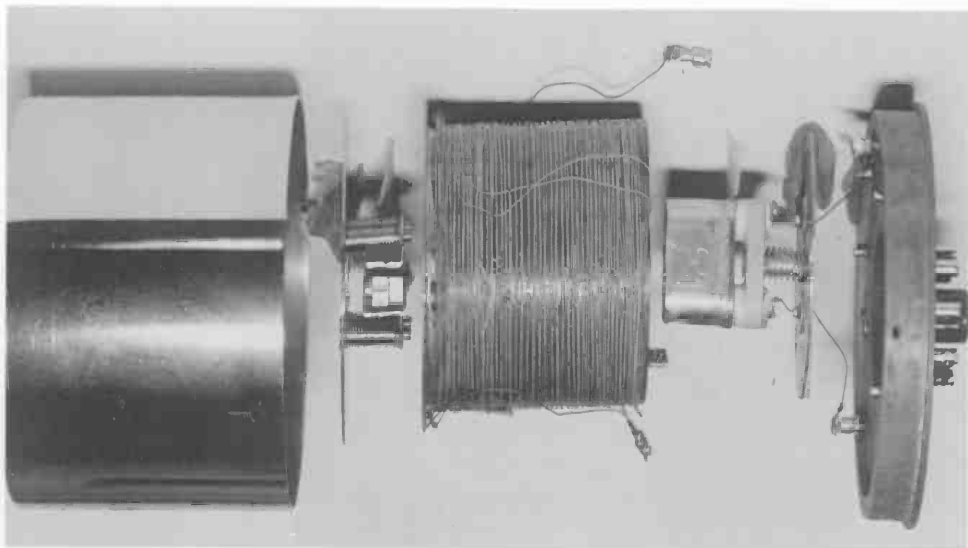

Unassembled view of a constant-temperature oven that stabilized the temperature of a quartz crystal for precise oscillator frequency control. Left to right are can, switch, heater, wire, crystal holder, and octal socket.

### The Speed of Light

One of the most important of the fundamental constants is the speed of light (always denoted by  $c$ ). In the words of Joseph F. Mulligan:

The velocity of light in a vacuum is one of the most fundamental quantities in nature. . . . In addition to the basic role it plays in the theory of relativity, the value of  $c$  must be known accurately for work in optics, electricity, quantum theory, and nuclear physics. For this reason a great deal of time and energy has always been devoted to its precise determination."<sup>216</sup>

Now, in the postwar years, using radar and microwave techniques developed during the war, values for the speed of light higher than the generally accepted prewar values were obtained.<sup>217</sup> As an example, the 1941 average value derived by Raymond T. Birge was  $(299\,776 \pm 4)$  km/s, but the 1953 value derived by Jessie W. M. DuMond

<sup>216</sup> J. F. Mulligan, "Some Recent Determinations of the Velocity of Light," *American Journal of Physics* 20 (1952): 165-172.

<sup>217</sup> Ibid.; This is also discussed by J. W. M. DuMond and E. R. Cohen, "Least-Squares Adjustment of the Atomic Constants, 1952," *Reviews of Modern Physics* 25 (1953): 691-708.

and E. Richard Cohen was  $(299\,790 \pm 0.9)$  km/s.<sup>218</sup> These results caused quite a bit of discussion in the scientific world. There was, in fact, even some theoretical work (since discounted) on the possibility that the speed of light showed some temporal oscillation.

Despite the importance of  $c$ , before 1955 the Bureau had made only one measurement of its value—by Edward B. Rosa and N. Ernest Dorsey in 1907.<sup>219</sup> They determined the speed of light by the classic method of measuring the ratio of the electrostatic unit of charge to the electromagnetic. To do this, they built two capacitors, one consisting of concentric spheres and another of coaxial cylinders. The capacitance in electrostatic units can then be calculated from the dimension, and the problem becomes one of the accurate measurement of these dimensions, at which Rosa and Dorsey were masters. The capacitance in electromagnetic units was determined (in modern terms) by measuring the impedance of the capacitors on a bridge in terms of the standard ohm. The ratio (which is the square of the speed of light) gave the value of  $c$  as  $2.9971 \times 10^{10}$  cm/s, with “an uncertainty of not more than 1 part in 10 000.” This remarkable result was corrected by Birge in 1941 to the value of  $(299\,784 \pm 10)$  km/s, a value just intermediate between the low prewar accepted values and the higher postwar values.

Now, in 1955, the Bureau supported two determinations of  $c$  by two widely different techniques, and in widely different locations. In Washington the determination was made by Earle K. Plyler, Lamdin R. Blaine, and William S. Connor of the Atomic and Radiation Physics Division, from an analysis of the rotational spectrum of carbon monoxide (CO).<sup>220</sup> In Boulder, the measurement by Edwin R. Florman of the Radio Propagation Physics Division was a direct determination of the wavelength of VHF radio waves of accurately known frequency by measuring a phase shift by what was essentially a microwave interferometer.<sup>221</sup>

---

<sup>218</sup> DuMond and Cohen, op. cit.; R. T. Birge, “The General Physical Constants,” *Reports on Progress in Physics*, VIII (London: The Physical Society, 1941): 90-134.

<sup>219</sup> E. B. Rosa and N. E. Dorsey, “A New Determination of the Ratio of the Electromagnetic to the Electrostatic Unit of Electricity,” *Bulletin of the Bureau of Standards* 3 (1907): 433-604.

<sup>220</sup> E. K. Plyler, L. R. Blaine, and W. S. Connor, “Velocity of Light From the Molecular Constants of Carbon Monoxide,” *Journal of the Optical Society of America* 45 (1955): 102-106.

<sup>221</sup> Edwin R. Florman, “A Measurement of the Velocity of Propagation of Very-High-Frequency Radio Waves at the Surface of the Earth,” *Journal of Research of the National Bureau of Standards* 54 (1955): 335-345. RP 2596. Part of this work was carried out during the move to Boulder, and even before the formation of the Propagation Physics Division. Nevertheless we shall continue to refer to it as the Boulder work.

The spectroscopic method rests on the fact that the rotational spectrum of CO can be determined either by microwave methods or by traditional—albeit specialized—spectrographic means. The microwave frequency of a rotational line is given by the sum of two terms, each term the product of a constant and  $(J+1)$ , or a power of it, where  $J$  is the rotational quantum number. The two constants,  $B_0$  and the much smaller  $D_0$ , both have the dimensions of frequency. In spectroscopy, the wave numbers of the transitions are given by a slightly more complicated expression involving the same two constants, as well as others. The units, however, are now wave numbers. Thus, if the constant  $B_0$  is determined by both microwave experiments and by spectroscopic means, in one case it will be expressed in cycles/s (Hz), and in the other case in  $\text{cm}^{-1}$ . The speed of light is then the quotient of the microwave value and the spectroscopic value.

The experimental details of the spectroscopic experiments are rather complicated. Suffice it to say that they involved fringes from a Fabry-Perot interferometer, calibrated by a standard, such as mercury-198 light to obtain the spacing of the fringes, which then acted as a ruler for determining the wave numbers of the lines in the CO spectrum.

This system, using hydrogen cyanide (HCN) was first used by David H. Rank, Ralph P. Ruth, and Kenneth L. Vander Sluis at the Pennsylvania State University to obtain the speed of light.<sup>222</sup> The microwave results were obtained by Arthur H. Nethercot, Jr., J. A. Klein, and Charles H. Townes of Columbia University.<sup>223</sup> The results were  $(299\,776 \pm 6)$  km/s for  $c$ , which was lower than the postwar measurements. The value was, however, subsequently revised to  $(299\,789.3 \pm 3)$  km/s, which was more in keeping with the newer results.<sup>224</sup>

The Bureau's spectroscopic analysis was made on CO by essentially the same method, with some improvements. Measurements were made both in absorption and emission by Plyler, Blaine, and Connor, and different standard wavelengths were used in calibration. The microwave analysis was made at Duke University by Otis R. Gilliam, Charles M. Johnson, and Walter Gordy.<sup>225</sup> The result for  $c$  was  $(299\,792 \pm 6)$  km/s. The spectroscopic results on two different compounds and involving four different laboratories confirmed the higher postwar values.

While the Bureau's Washington group was carrying out its measurements, Florman was using a totally different method for his determination of  $c$ . The method was based on the fundamental relationship that the velocity of a wave is given by the product of

---

<sup>222</sup> D. H. Rank, R. P. Ruth, and K. L. Vander Sluis, "Precision Determination of the Velocity of Light Derived from a Band Spectrum Method," *Journal of the Optical Society of America* 42 (1952): 693-698.

<sup>223</sup> A. H. Nethercot, Jr., J. A. Klein, and C. H. Townes, "The Microwave Spectrum and Molecular Constants of Hydrogen Cyanide," *Physical Review* 86 (1952): 798.

<sup>224</sup> Plyler, Blaine, and Connor, "Velocity of Light": 102-106.

<sup>225</sup> O. R. Gilliam, C. M. Johnson, and W. Gordy, "Microwave Spectroscopy in the Region From Two to Three Millimeters," *Physical Review* 78 (1950): 140.

its frequency and wavelength.<sup>226</sup> Very-high-frequency transmitters with frequencies calibrated against the national frequency standard were, of course, available in the Radio Propagation Physics laboratories in Boulder. If the wavelength could be measured very accurately, then  $c$  followed immediately. To measure the wavelength, Florman essentially built a microwave interferometer, which operated in the following way. Two receivers were placed an accurately known distance apart. Clearly, if the total number of wavelengths separating the receivers (i.e., the phase difference between them) is known, then the wavelength is calculated easily. To understand the basis of the experiment, imagine now a transmitter located exactly on the line connecting the two receivers. If the transmitter is moved from one point to another on this line, the phase of the signal at the two receivers will change, with the phase retarded at one receiver, and advanced at the other. This change in the phase difference is readily measured. The phase difference between the end points of the distance over which the transmitter was moved is then just half this measured change in phase difference. Florman actually used the phase difference between the two receivers to obtain maximum accuracy, and the measurement—the details of which are too complicated to describe here—involved three transmitters as well as the two receivers. The frequency of the transmitters was 172.800 MHz (wavelength approximately 1.73 m) and the distance between the two receivers was accurately determined to be 1500 m. The survey was carried out using U.S. Coast and Geodetic Survey techniques, with three 50 m invar tapes calibrated by the Bureau. The measurements were thus directly related to the national standards of length and time. The measurements were carried out at three sites: at an abandoned airport near Willard, Virginia (now the site of Dulles International Airport), for preliminary tests; a dry lake bed near Willcox, Arizona, where most of the measurements were made; and a final series of system tests at Sterling, Virginia. The final weighted average of 110 measurements of  $c$  was  $(299\,795.1 \pm 3.1)$  km/s. Within the stated uncertainty, this value was the same as was obtained by the spectroscopic means. The Bureau's results showed that the postwar results were indeed higher than the prewar. What was happening? The answer was very simple. As discussed by DuMond and Cohen, the difficulty lay with an improper weighting of experimental results of different workers in arriving at average values. While its true average value was higher than previously believed,  $c$  was indeed a fundamental constant. In fact, the measurement of  $c$  became so precise that the uncertainty in the realization of the meter became the main source of error. As a result, in 1983  $c$  was *defined* to be 299 792 458 m/s, and the standard of length was defined in terms of this value and the second.<sup>227</sup>

---

<sup>226</sup> Florman, "Measurement of the Velocity of Propagation." Another description, and more detail, along with one for the spectroscopic measurements, is given in "Velocity of Light Redetermined; Higher Values Confirmed," *Technical News Bulletin* 39 (1955): 1-3.

<sup>227</sup> D. A. Jennings, R. E. Drullinger, K. M. Evenson, C. R. Pollock, and J. S. Wells, "The Continuity of the Meter: The Redefinition of the Meter and the Speed of Visible Light," *Journal of Research of the National Bureau of Standards* 92 (1987): 11-16.



## TESTING

Routine testing of commercial products for compliance with specifications in Government purchases does not devolve directly from the Bureau's 1901 Organic Act unless it is considered to come under Stratton's catchall phrase, "the solution of problems which arise in connection with standards."<sup>228</sup> Despite this, such testing was an integral part of the Bureau's activities starting in 1904 when, at the request of another Government agency, the Bureau tested a batch of light bulbs of a type that had been burning out at a great rate. The Bureau promptly failed more than three-quarters of the bulbs because they did not meet the Government's rather simple specifications, nor, indeed, those of the manufacturer. Yet other agencies sent samples of clinical thermometers, inks, chemical glassware, and other commodities, and when the Bureau found similarly useful results, the other agencies realized that large sums of money could be saved by the Bureau's testing, and such testing became an established part of the Bureau's activities.<sup>229</sup> This activity was authorized in the 1950 revision of the Organic Act by the inclusion in Sec. 2 of the statement:

"(c) The development of methods for testing materials, mechanisms, and structures, and the testing of materials, supplies, and equipment, including items purchased for use of Government departments and independent establishments."

Indeed, the Bureau had gone further and provided testing for such regulatory agencies as the Federal Trade Commission, which was concerned with false advertising claims, and the Post Office Department, which was concerned with mail fraud. It was this latter testing that led to the AD-X2 debacle and the Kelly Committee Report.

The Kelly Committee Report was ambivalent about product testing. It tended to be repetitive and routine, so that the committee wrote:

The Committee is concerned that a larger amount of repetitive testing is now done in the Bureau than is necessary with the present state of development of technology in industry. . . . The Committee recommends that the repetitive test operations of the Bureau be critically examined. . . . The personnel and facilities of the test program area of the Bureau should be primarily employed in the development of specifications and testing and quality control procedures.<sup>230</sup>

<sup>228</sup> The word "testing" is used with a number of meanings. We use it here to denote the investigation of a material or instrument by subjecting it to a test, or a series of tests, to determine if it complies with a specification. A simple example would be the carrying out of a test on a sample of steel to determine its tensile strength. Calibrations, which are the comparison of measuring instruments with standards to determine how closely they correspond to the standard, are excluded from this definition. Also excluded are longer investigations such as the ship plate study described in this chapter, which are more in the nature of research projects within which various tests may be carried out.

<sup>229</sup> An excellent account of the early history of the Bureau's involvement in such commodity testing is given in MFP, 90-96.

<sup>230</sup> Kelly Committee Report: 15-16.

Despite these statements, the committee gave rather high marks to the cement testing program—the largest at the Bureau—since it served only the Government and saved a great deal of money.

Nevertheless the Bureau seriously undertook to clarify and revise its testing program, including calibrations. First, in the area of calibrations, many of which were indeed repetitive and routine, the Bureau “instituted a policy of restricting the calibration services, insofar as possible, to the calibration of basic standards. . . . [T]ests of products were made only at the request of other Government agencies except when the Bureau possessed facilities not available elsewhere or in the rare instances when referee tests were required.”<sup>231</sup>

In a series of conferences with Government and industry users of Bureau services, these policies were announced in August 1953, before the Kelly Committee Report was officially received. While the conferences were successful in making the Bureau’s position known, they were not very successful in helping the Bureau to divest itself of routine calibrations. This was partly caused by the fact that it was too difficult to assign priorities in calibration services, and that routine calibrations “did not appear attractive as a commercial venture” for commercial testing laboratories.<sup>232</sup>

As part of this re-analysis of its position with respect to acceptance testing, the Bureau consummated an agreement, codified by a Memorandum of Understanding, with the General Services Administration, the most important of the Government agencies involved in this area.<sup>233</sup> In the agreement, the position and responsibilities of the two sides are laid out. With respect to specifications, the agreement reads:

The General Services Administration will endeavor to assign to the National Bureau of Standards specifications projects for general methods of test and for end products which come within the scope of the technical competence and interest of the Bureau.

The Bureau thus looked upon itself as the place to develop general test methods, but when specific products were involved, it would work on those in which it was already technically competent or was interested. Similar limitations were laid on testing. Here the agreement reads:

When qualification tests are called for by a specification or are required by Federal Supply contracts in connection with a procurement under a specification prepared by the National Bureau of Standards, the General Services Administration will designate the Bureau as the laboratory to make the tests. . . . The General Services Administration will make every reasonable effort to send to the Bureau for acceptance testing a portion of the samples of those products for which the specifications have been assigned to the Bureau.

---

<sup>231</sup> Annual Report, 1953-1954: 96.

<sup>232</sup> *Ibid.*, 97.

<sup>233</sup> Annual Report, 1953-1954: 131.

And the Bureau agreed to act as a type of monitor:

The National Bureau of Standards will undertake to conduct a program of interlaboratory testing to aid in maintaining a uniform high quality of acceptance testing on the part of all laboratories concerned with Government procurement that are willing to participate.

The GSA agreement shows that the Bureau was not prepared to divest itself of routine acceptance testing, but rather to better define its role in the activity. While it would have preferred to follow the recommendations of the committee and limit itself primarily to the development of test methods, both general and specific, it would develop specifications in those areas where it had competence and interest, and it wanted to limit itself to the routine testing of only those products for which it had developed specifications. With these policies, its routine testing work did not rapidly decrease. Due to the large effect of the Korean War and the Bureau's lumping together calibrations and acceptance testing, it is difficult to make concrete, year-to-year comparisons of the amount of such testing work. Nevertheless, there does not seem to have been a significant decrease in such work as late as 1962. To pick only the areas of lamp and cement testing, in 1952 the Bureau tested 4500 light bulbs (representing a total of 7 million), and 26 000 samples of cement (representing 15.8 million barrels). The comparable figures for 1962 were 4300 light bulbs and 21 000 cement samples. The figures for other commodities, such as paper, textiles, rubber, leather, and plastic products, and various building materials show similar behavior. It would be some time before the Bureau ended its routine acceptance testing.

The situation with respect to calibrations was quite different. Here the Bureau's aim was to divest itself of routine bulk calibrations and limit itself to calibration of master standards for other standards laboratories, in effect adding another link in the standardizing chain. Its aim was to encourage the formation of such laboratories, both private and public. As stated by Astin in a speech at the dedication of the IT&T Standards Laboratory in 1957:

It is a matter of some concern to us that the demands for standards, measurement techniques, and precise testing and calibration have out-distanced our ability to provide direct service. The fact is that the research and development requirements of our programs are such that we can at best provide only very limited direct service to the public. We consider that we are a scientific service agency. By that I mean, we seek to serve central or key professional organizations, to calibrate master instruments and transfer standards, and to enable competent private standardizing and testing laboratories to provide effective and valuable measurement services to the scientific and industrial communities. . . . With the cooperation of laboratories such as this one, the program of precision measurement will have a multiplied effect upon the nation.<sup>234</sup>

---

<sup>234</sup> A. V. Astin, "A Service for the Nation's Technology," *The Magazine of Standards* 57 (1957): 197-198.

At first, the formation of private standards laboratories went slowly, but by 1956 with the pressing need for ever higher accuracy led by the electrical industry, a number of large manufacturing industries and military organizations established their own standards laboratories. Moreover, in the same year, the Eli Whitney Laboratory, the first commercial for-fee standardizing laboratory, was established. By 1961 the movement had progressed to the point that a new organization—the National Conference of Standards Laboratories (NCSL)—was formed. This conference brought together representatives from commercial, military, and university standards laboratories to “promote cooperative action on common problems of management and operation of measurement standards and calibration laboratories.”<sup>235</sup> The Bureau was on its way to divesting itself of the drudgery of routine calibrations and limiting itself to standardizing only the master standards of a group of secondary standards laboratories.

## SUMMARY

The first seven years of the fifties decade were dramatic auspicious years for the Bureau. Paralleling the history of the Nation, the Bureau passed through turbulent, tumultuous years at the beginning of the decade and then entered a calmer period full of hope and confidence. The AD-X2 affair, with its drama and trauma, caused the Bureau, by the mechanism of the Kelly Committee Report, to look inward and rediscover and reaffirm the principal reasons for its existence. To the Nation’s obsession with communism it lost the best—and perhaps most charismatic—scientist ever appointed as director in its history, but he was replaced by a dogged, consummate tactician with an unparalleled sense of personal and official integrity and of Bureau mission. It acquired a new Organic Act which, if it did not materially change the Bureau’s responsibilities and authority, at least clarified them and made them more specific. It had grown to the largest size in its history and, if at one stroke of the pen it had lost 2000 of its 4800 staff to newly-formed organizations, the loss was not a punishment, but a result of having done its war-emergency job too well. And if, under pressure of the emergency, it had lost sight of the primary reason for its existence, it set about to reaffirm its basic mission.

In the process the nature of its work began to change, becoming more basic, more fundamental; for the Nation’s science and technology, growing explosively, demanded this of the Nation’s central measurement laboratory. In the process of carrying out this reaffirmation, it made changes that forever altered its mode of operation. On the fiscal side, it was permitted to retain fees it charged for calibrations and standard samples, thereby substantially increasing its income. And new legislation permitted it to establish a working capital fund, which made its fiscal operations more businesslike and, at least partially, removed the stringent onus of fiscal-year funding. In conformance with the recommendations of the Kelly Committee on the operational side, it established advisory committees to each of its divisions, an addition that was forever to change the management process at the Bureau. Also on the operational side, it established a

---

<sup>235</sup> Annual Report, 1962: 13.

program under which postdoctoral research associates could be brought into the Bureau. No other Bureau program would have as great an effect on its scientific competence.

Finally, while decreasing in staff, the Bureau grew in extent. It acquired a new site in Boulder, Colorado, with almost three times the land area of the Van Ness site, and firm plans were made to move to a bucolic site two and one-half times the size of the Boulder site near the small Maryland town of Gaithersburg.

By the time the sputniks were launched in late 1957, the Bureau was well on its way to becoming a laboratory new in spirit and facilities. It was about to enter into some of its most rewarding and scientifically productive years.

---

## CHAPTER FOUR

---

### REORIENTATION AND RECONSTITUTION, 1958-1964

#### THE BEGINNING OF A TIME OF TURMOIL

When *Sputnik 1* was launched near the end of 1957, the United States was entering a period of great agitation. In fact, while the fifties are remembered as a decade of placidity and conformity, the sixties are remembered as a decade of turmoil and turbulence.<sup>1</sup> Names and events capture the agitation of the times: black student sit-ins at lunch counters in Greensboro, North Carolina; police dogs and water cannons attacking peaceful civil-rights demonstrators in Birmingham, Alabama; hippies and the drug culture in Haight-Ashbury; race riots and flames in northern cities and the Watts section of Los Angeles. There were college students rebelling against authorities at Berkeley and Columbia, pitched battles between police and radical youth at the 1968 Democratic convention in Chicago, and young people exploring alternative cultural forms at Woodstock. It was a time of peace marches, draft-card burnings to protest the Vietnam War, and of shocking government violence at Kent State. It was the era of the Bay of Pigs misadventure, of the building of the Berlin Wall, of Gary Powers and the U-2 spy plane incident, and of the Cuban missile crisis. The decade was punctuated with assassinations: Medgar Evers, John F. Kennedy, Martin Luther King, Jr., and Robert F. Kennedy.

Not all the events were dire. Other events were happy, and some even noble: Martin Luther King's "I Have a Dream" speech before the Lincoln Memorial; President Kennedy's request that citizens ask themselves what they could do for their country; President Lyndon B. Johnson's announcement of the passage of a comprehensive civil rights bill barring discrimination on the basis of color, national origin, or gender and his announcement of plans for a "Great Society;" Neil Armstrong's footsteps on the Moon.

Like the blows of a forge hammer on iron, these events beat the society into new legal and cultural forms with lasting effect. Foremost among the legal changes was increased civil rights protection. Although *de facto* equality was still not realized, the basis for achieving complete legal equality was laid. On a cultural level, sexual taboos were overridden, with consequences welcomed by some and abhorred by others. A drug culture was established, with unwelcome ramifications for the whole society. But perhaps the most important cultural change was society's altered attitude toward authority. Where it had once been uncommon to question government, law enforcement, and parents, now such questioning was not only done with impunity, but expected of all thinking citizens.

---

<sup>1</sup> Paul Johnson, *Modern Times: The World From the Twenties to the Eighties* (New York: Perennial Library, 1985). Johnson calls the section dealing with these years "America's Suicide Attempt."

## Foreign Affairs

After the flight of the sputniks, Senator Styles Bridges of New Hampshire noted that the "time has clearly come to be less concerned with the depth of pile of the new broadloom rug or the height of the tail fin of the new car and to be more prepared to shed blood, sweat and tears."<sup>2</sup> *Sputnik I* was one factor that began jolting the Nation out of its 1950s complacency. Americans were ready to ascribe to Russia a capability that it did not have and to assert a missile gap that did not exist. This feeling was not assuaged when the Nation's first attempt at orbiting a satellite failed on national television.

President Dwight D. Eisenhower was chagrined and nonplussed by public reaction to the sputniks. He had been under great pressure to increase defense spending but had resisted, for he knew that no missile gap existed.<sup>3</sup> The president knew that the Nation's missile program was on schedule, and through U-2 reconnaissance was aware of the status of Soviet efforts. Indeed, before the end of the decade, Atlas, the first U.S. intercontinental ballistic missile (ICBM), became operational. Titan had begun to be developed in 1955, and the solid-fueled Polaris in 1956. In the early sixties, Minuteman, a solid-fueled ICBM, became ready for use. Convinced that public reaction was out of proportion to the danger, the president travelled around the Nation, attempting to reassure the populace that the sputniks did not represent a threat to national security.

The United States could have launched a satellite a full ten months ahead of the Soviets, but it would have been a military effort that Eisenhower did not want. The President preferred to wait until January 31, 1958, when a civilian satellite, *Explorer I*, would be launched as part of the International Geophysical Year.<sup>4</sup> Although launched by the Army Ballistic Missile Agency using the Jupiter-C rocket designed by that agency and the Jet Propulsion Laboratory, *Explorer I* was a civilian endeavor.<sup>5</sup> But the sputniks sped up the satellite effort, and a full-scale space race was on.<sup>6</sup> In May 1958 Eisenhower proposed the formation of a civilian space agency, and on July 29, 1958, Congress passed the National Aeronautics and Space Act, thereby forming the National Aeronautics and Space Administration (NASA) on the bones of the old National Advisory Committee for Aeronautics.<sup>7</sup>

Three years later, with Kennedy in office, another Soviet space spectacular shook the Nation. On April 12, 1961, the Soviets launched into orbit a satellite carrying Yuri Gagarin, the first cosmonaut. President Kennedy felt frustrated. As reported by the

---

<sup>2</sup> William L. O'Neill, *American High: The Years of Confidence, 1945-1960* (New York: The Free Press, 1986): 271.

<sup>3</sup> James Everett Katz, *Presidential Politics and Science Policy* (New York: Praeger Publishers, 1978): 119; O'Neill, *American High*: 270-272.

<sup>4</sup> O'Neill, *American High*: 273.

<sup>5</sup> Hugh Odishaw, "International Geophysical Year," *Science* 128 (1958): 1608.

<sup>6</sup> Katz, *Presidential Politics*: 119; O'Neill, *American High*: 273.

<sup>7</sup> *National Aeronautics and Space Act of 1958, U.S. Statutes at Large*, 72 (1958): 426.



An Atlas ICBM was shrouded for security as it moved through an unidentified town en route from San Diego to the Air Force missile testing center in Cape Canaveral, Florida (1957). (AP-Wide World Photos)

Washington bureau chief of *Time*, Hugh Sidey, at a White House meeting, Kennedy stormed: "Is there any place where we can catch them? What can we do? Can we go around the Moon before them? Can we put a man on the Moon before them? . . . Can we leapfrog? . . . If somebody can just tell me how to catch up! Let's find somebody, anybody. I don't care if it's the janitor over there, if he knows how."<sup>8</sup> In May 1961 the president publicly committed the Nation to landing a man on the Moon and returning him safely to Earth by the end of the decade. The Apollo Program was born.

Far more than any other foreign policy event, the sputniks influenced the programs of the Bureau. Three other events, however, recall the tenor of the times. Seeking to establish friendly relations with the Soviets and to promote peace between the two countries, Eisenhower invited Premier Nikita Khrushchev to the United States in 1959. Although miffed because of his inability to visit Disneyland (for security reasons), Khrushchev enjoyed his American tour. In the friendly "spirit of Camp David," he and Eisenhower arranged for a Paris summit conference to be held in August 1960. However, on May 1 of that year, the Soviet Union shot down and captured American pilot Gary Powers in one of the U-2 spy aircraft regularly used to fly over the Soviet Union. Unable to believe that Powers had survived despite the array of devices meant to destroy both the aircraft and its commander in the event the plane was hit, Eisenhower maintained that the U-2 was merely a weather plane. But Khrushchev produced both plane parts and pilot, catching the administration in a web of lies. The summit conference was aborted, and hopes for detente were dashed.

A far more serious encounter faced Eisenhower's successor, John F. Kennedy, in the second year of Kennedy's administration. In the wake of the abortive Bay of Pigs invasion in early 1961, the peace treaty between the Soviet Union and East Germany,

<sup>8</sup> Johnson, *Modern Times*: 629; Katz, *Presidential Politics*: 143, gives a slightly different version.



and the construction of the Berlin Wall, Khrushchev began the drastic step of emplacing missiles in Cuba. There was no hope of keeping this action a secret, and on October 15 newly constructed missile sites were photographed by a U-2 aircraft.<sup>9</sup> On October 22, while the armed forces were on “maximum alert,” ninety B-52s with multi-megaton bombs were poised over the Atlantic, and nuclear warheads were activated on 100 missiles as Kennedy explained to the Nation what had occurred. He announced that he was instituting a “quarantine” of the island. On October 24, Soviet missile-carrying ships approached but did not cross the quarantine line, whereupon Kennedy wired Khrushchev, to request the removal of the missiles or, in his words, “a restoration of the earlier situation.” In return for an American promise not to invade Cuba, Khrushchev removed his missiles from the island.<sup>10</sup> Both sides had faced the abyss of nuclear war but had not fallen in.



A U.S. Navy patrol plane hovered overhead as the destroyer U.S.S. *Barry* pulled alongside the Soviet freighter *Anesov*. The Soviet vessel carried a presumed cargo of outbound canvas-covered missiles. The removal of missiles from Cuba in 1962 by the U.S.S.R. brought an end to the Cuban missile crisis. (AP-Wide World Photos)

<sup>9</sup> Johnson, *Modern Times*: 625-626. It was not a small emplacement. It was to have contained 42 medium-range strategic missiles, 24 longer-range (2200 miles) missiles, 24 surface-to-air missile groups, and 22 000 Soviet troops and technicians.

<sup>10</sup> *Ibid.*, 625-627.

But the defining foreign-policy event of the late fifties and early sixties was not the sputniks, the U-2 shoot-down, or the Cuban missile crisis, but the Vietnam War. This was not started by an individual event about which it could be said, "Before it we were not at war, and after it we were." Rather, a series of incremental events led the Nation into the quagmire of Vietnam. Perhaps, as historian Paul Johnson points out, the two events during the fifties and early sixties that were most influential in drawing the United States into the war were Eisenhower's refusal to sign the Geneva accords which called for free Vietnamese elections in two years, and Kennedy's acquiescence to the overthrow of South Vietnam's leader, Ngo Dinh Diem.<sup>11</sup>

### National Affairs

When the sputniks flew, the Nation was approaching the end of the placid fifties. It had been a prosperous decade, analyzed by the economist John Kenneth Galbraith in his best-selling book *The Affluent Society*. In Galbraith's view, the modern industrial states had "mastered the difficulty of producing goods," and the days of shortages were over; the only remaining problem was the equitable distribution of goods. This was not only an economic problem, but a political one as well.<sup>12</sup> It was a problem not easily solved. Indeed, from 1958 to 1964, the principal domestic issue was the distribution of economic goods and political rights to African Americans. In short, the issue was civil rights.

Following the successful completion of the Montgomery, Alabama, bus boycotts at the close of 1956, African Americans had a new organization, the Southern Christian Leadership Conference (SCLC), and a charismatic leader who preached nonviolent, Gandhi-like protest, Martin Luther King, Jr. But this success did not mean that equality had arrived. In 1957, Arkansas Governor Orville Faubus refused to allow "black" students into "white" public schools, openly defying the Supreme Court's ruling in *Brown v. Board of Education*. Faubus's hard-line stance necessitated Eisenhower's reluctant use of a thousand paratroopers to force integration past an angry mob of white citizens. As late as 1961, James Meredith's attempt to be admitted to the University of Mississippi caused a riot that could not be controlled by 500 Federal marshals. As a result, President Kennedy federalized the Mississippi National Guard. Scores of marshals were injured, hundreds of rioters were taken into custody, and two bystanders were killed.

Beyond the segregation of schools, the South still had segregated public eating places, toilets, and bus and train waiting rooms. Throughout the Nation, housing was segregated. Young African Americans, most of them college students—largely from black colleges—picked up the struggle in Greensboro, North Carolina, where they worked to desegregate lunch counters. Studiously courteous and nonviolent, their example was followed in many other places in the South, and they gained considerable sympathy

---

<sup>11</sup> Ibid., 632-633.

<sup>12</sup> Ibid., 613.

from at least the northern segment of white society. They were followed by the "freedom riders," whose simple demand that interstate bus terminals be integrated provoked such vicious attacks that Federal marshals had to be called upon to protect them. Other sit-ins, demonstrations, wade-ins and boycotts followed. Sympathy for the black push toward equality mounted slowly in the white population, but the defining incident occurred in Birmingham, Alabama.

It was the SCLC's strategy to carry out "mass demonstrations and store boycotts" in Birmingham in the hope of splitting the business elite from the white leadership.<sup>13</sup> After a few skirmishes between civil rights protestors and the police, Eugene "Bull" Connor, Birmingham commissioner of public safety, obtained an injunction against further demonstrations. When the SCLC persisted, the leaders were thrown into jail.<sup>14</sup> King was held incommunicado, without mattress and blankets, until his wife Coretta contacted President Kennedy. After Kennedy's intercession King's lot improved, but the men, women, and children who marched on the Birmingham city hall were set upon by police dogs, buffeted by water from high-pressure fire hoses, and jailed. King and the other leaders were released, but the marches, dog attacks, hosing, and jailing continued. The scenes of dogs and water cannons assaulting helpless people, many of them women and children, helped to create a great deal of support for the demonstrators, and the White House sent in mediators. Although city officials remained intransigent, the business community, faced with a "paralyzing boycott and damning publicity, agreed to desegregation demands." The SCLC's strategy had worked as intended and it was clearly a victory for the African Americans.<sup>15</sup>

Martin Luther King, Jr., first visited the White House in 1961. He left somewhat disappointed. Concerned about his southern support, Kennedy was slow to move on civil rights. Finally, in June 1963 while southern killings continued, he called for new legislation. Medgar Evers, an NAACP official, was killed in his Jackson, Mississippi, home on June 12, and four black girls were killed in a church bombing in Birmingham in September. On August 28, 250 000 persons of all colors marched on Washington and assembled at the Lincoln Memorial to support civil rights and hear King's "I Have a Dream" speech. It was clear that the time had arrived for something to be done. But, like a historical exclamation point to this era, a killing unrelated to civil rights took place. On November 22 in Dallas, President Kennedy was struck by an assassin's bullets.

Kennedy's civil rights bill had not been passed and, ironically, it might not have passed had he lived. However, the new president, Lyndon B. Johnson, who had been looked upon with skepticism by the civil rights movement because of his southern background, saw the bill through Congress with his masterful knowledge of that institution's workings. On July 2, 1964, a civil rights bill that forbade discrimination in most public facilities was passed and became the law of the land. In 1965 Johnson

---

<sup>13</sup> James MacGregor Burns, *The Crosswinds of Freedom: From Roosevelt to Reagan—America in the Last Half Century* (New York: Vintage Books, 1990): 367.

<sup>14</sup> It was here that King wrote his famous "Letter from Birmingham Jail."

<sup>15</sup> Burns, *Crosswinds of Freedom*: 368.

shepherded through Congress a voting rights bill that banned literacy tests and provided for Federal registrars. There was still a long way to go, but most of the basis for legal equality was now at hand.

During the period the public became more concerned with the environment, an area in which the Bureau would get more deeply involved. The most potent catalyst in increasing this concern was Rachel Carson's publication of *Silent Spring* in 1961, ten years after her other famous book, *The Sea Around Us*. Combining a poetic vision with sound scholarship, Carson laid open to public view the destruction of the environment by booming industries, the dumping of chemicals, and the indiscriminate use of herbicides and pesticides. Also important in awakening public sensitivities to the environment were Jacques Cousteau's vivid pictorial documentations of the beauty—and fragility—of the undersea world.

Congress also became more active on environmental issues. Four pieces of legislation were passed during the period, two dealing with air pollution, one with water pollution, and the fourth dealing with the control of the sale of pesticides and other poisons. In 1959, the original Insecticides, Fungicides, and Rodenticides Act, which controlled the sales of poisons for "insects, rodents, fungi, weeds, and other forms of plant or animal life . . . which the secretary [of agriculture] shall declare to be a pest" was expanded to include nematocides, plant regulators, defoliant, and desiccants; and the power of the secretary was somewhat expanded in determining what was considered proper labelling.<sup>16</sup> Similarly, the Water Pollution Control Act of 1948 was significantly amended to require that research and studies be carried out on the treatment of municipal sewage, on the effects of pollution on water, on the effect of augmented flows on water quality, and on the waters of the Great Lakes.<sup>17</sup>

The first amendment of the original 1955 air pollution law, passed in 1962, was very brief but notable for its recognition of air pollution by motor vehicles. It instructed the surgeon general to study the substances emitted by motor vehicles to determine their effects, both harmful and benign. A little more than a year later, the comprehensive Clean Air Act was passed, having as its purposes the protection of the Nation's resources, the initiation of a national research and development program, and the provision of assistance to state and local governments. The comprehensive act again singled out motor-vehicle pollution. It mandated the formation of a committee that would monitor progress in the automotive and fuel industries and required a semi-annual report on progress from the secretary of health, education, and welfare. Slowly the Nation was becoming serious about the environment.<sup>18</sup>

---

<sup>16</sup> *Federal Insecticide, Fungicide, and Rodenticide Act, U.S. Statutes at Large*, 61 (1947): 163; *Nematode, Plant Regulator, Defoliant, and Desiccant Amendment of 1959, U.S. Statutes at Large*, 73 (1959): 286.

<sup>17</sup> *Water Pollution Control Act, U.S. Statutes at Large*, 62 (1948): 1155; *Federal Water Pollution Control Act Amendments of 1961, U.S. Statutes at Large*, 75 (1961): 204.

<sup>18</sup> *Air pollution control, U.S. Statutes at Large*, 69 (1955): 322; *Air pollution control, U.S. Statutes at Large*, 76 (1962): 760; *Clean Air Act, 77 (1963): 292.*

## THE GLORY DAYS

Scientists at work in the late fifties and early sixties would later recall these years as a golden age of science. Times were good. The esteem placed by Vannevar Bush on basic research in *Science, the Endless Frontier*, and formalized by the establishment of the National Science Foundation in 1950, was unquestioned. Many industrial corporations gave their scientists new freedom in doing research, and science had wide public support. Most important, research and development expenditures continued the steep upward climb begun at the end of World War II. Between 1957 and 1964, while the gross national product was increasing by a factor of 1.43 (in current dollars), national expenditures for research and development increased by a factor of 1.93, averaging a yearly growth rate of 13.41 percent. Expenditures by the Federal Government increased by a factor of 2.05, an even greater growth rate. And the character of the work was changing, with basic research increasing still faster. Thus, national expenditures for basic research increased by a factor of 2.99, and such expenditures by the Federal Government alone increased by a whopping 3.91. Even the Federal Government in-house expenditures for basic research increased by the substantial factor of 2.98. These were times that were destined to make the research scientist happy.<sup>19</sup>

Science also achieved a loftier position within the Federal Government. In the wake of the sputniks, President Eisenhower formed the President's Science Advisory Committee (PSAC), whose chairman was instantly known as the presidential science advisor. Science now had a presence in the White House with an advocate who had the president's ear.

A year later, on March 13, 1959, the president formed the Federal Council for Science and Technology (FCST) by Executive Order 10807. Composed of the science advisor and officials from all the departments and agencies concerned with science, the aim of the Council was to provide a means for closer collaboration and cooperation among Federal agencies involved in scientific matters. FCST was to consider the effects of new developments and problems in science, provide more effective planning and administration of programs, identify research needs, avoid duplication, and further promote international cooperation. Its chairman was to be designated by the president, and the position came to be occupied by the science advisor.

Apart from the White House, PSAC assisted in the creation of a new policy body, the Office of the Director of Defense Research and Engineering, under the secretary of defense. In February 1958, DOD formed the Advanced Research Projects Agency (ARPA) to handle its long-range projects. Early in the same year, the National Academy of Sciences (NAS) gave formal recognition to the new area of space science with the creation of the Space Science Board. And the formation of NASA in July 1958 further spurred the new science and provided vehicles for new developments in astronomy, earth sciences, and communications. Closer to home, the Department of Commerce, along with various other agencies, formed a new post of assistant secretary for science and technology, with important consequences for the Bureau. The persons filling these positions generally represented their agencies on FCST.

---

<sup>19</sup> *Historical Statistics of the United States: Colonial Times to 1970. Parts 1 and 2* (Washington, D.C.: Bureau of the Census, 1975): 224, 965.

The election of President Kennedy also gave science a sympathetic ally. In a May 1961 message to Congress, Kennedy announced his plans for a manned lunar landing. In June 1962, with the acceptance of Congress, the President formed the Office of Science and Technology (OST) in the Executive Office of the President.<sup>20</sup> With the science advisor heading OST, science policy advice was no longer denoted as a White House staff function, but rather as a full office. The main aim, originally proposed by Senator Henry Jackson's Subcommittee on Government Operations, was to provide a mechanism for determining and coordinating science activities in the Government. To that end, the National Science Foundation function "to evaluate scientific research programs undertaken by agencies of the Federal Government" was transferred to OST. But while the office could evaluate programs and had responsibility to coordinate them, it had no line authority. It was still an advisory body, although it—and hence all of science—had a voice at the highest level.<sup>21</sup> These were glory days indeed.

The pace of technological change and scientific discovery did not slacken during this period.<sup>22</sup> The electronics revolution based on the transistor and on solid-state physics continued. In 1959 Sony introduced the first solid-state television set, and in the same year the first fully transistorized business computer, the RCA 501, was manufactured. As a harbinger of what was to come, the first integrated circuits were used for gates and logic circuits in computers designed for military purposes. In communications, a marriage of solid-state electronics and space capabilities produced two developments that would "shrink the world." In 1960, *Echo*, the first (passive) communications satellite, was placed into orbit, and two years later, on July 10, 1962, *Telstar* was launched, relaying the first transatlantic television pictures. In a few years, world news would be seen in "real time." Two other developments would revolutionize the office and the home. In 1959 Xerox introduced the first commercial copy machine, bringing joy to the lives of stenographers and paper manufacturers. In 1964 the first permanent-press clothing was introduced, bringing delight to housekeepers and despair to the manufacturers of flatirons and cotton fabrics. In space, the Soviet Union made two advances. Although they would eventually be overshadowed by the United States feat of landing a man on the Moon, these accomplishments made headlines at the time. In 1959 the Soviet *Lunik II* landed on the Moon, the first man-made object to do so, and in the same year *Lunik III* returned pictures of the far side of the Moon—the first time that mankind had seen the back of its celestial neighbor.

Progress in the field of basic science was even greater, if less spectacular. In astronomy a new class of celestial objects, the quasar (for quasi-stellar object), was discovered. These objects, enormously distant, as shown by their large red-shift, and

---

<sup>20</sup> *Reorganization Plan No. 2 of 1962, U.S. Statutes at Large*, 76 (1962): 1253. Ironically, the OST had little input into the lunar landing decision. Kennedy obtained his advice from his line organization, i.e., NASA. Jerome Wiesner, then director of OST, was to state later that this came about because NASA and OST differed on the details of how the mission should be carried out, with NASA planning on a "straight shot" while OST proposed going via a space station. Kennedy could hardly go against his line organization in such a crucial matter. (From author's personal recollection; see also Katz, *Presidential Politics*: 143)

<sup>21</sup> Katz, *Presidential Politics*: 39-40.

<sup>22</sup> Alexander Hellemons and Bryan Bunch, *The Timetables of Science: A Chronology of the Most Important People and Events in the History of Science* (New York: Simon and Schuster, 1988).

enormously bright as shown by their immense luminosity, excited considerable speculation as to their nature. No known source could power such a massive output of energy. Later it would be proposed that the far-away quasars were very early galaxies with immense black holes at their centers.

At the opposite extreme of dimensions, Murray Gell-Mann of the California Institute of Technology (and independently Yu'val Ne'eman at Imperial College, London) introduced what Gell-Mann called the "eightfold way." A means of classifying the observed family of subnuclear particles, this method would lead to the concept of quarks, to quantum chromodynamics, and to the standard model of elementary particles. In other notable discoveries in elementary particle physics:

- Gordon Danby and his group showed that there are two types of neutrinos, the known one associated with the electron and another associated with the muon. It is now known that there is a third neutrino associated with the tau lepton, giving a family of six so-called leptons. Later it would become a part of the standard model that six quarks exist in symmetry with the leptons.
- Gerhart Lüders and Wolfgang Pauli proved the CPT theorem that conversion of a particle into its anti-particle, along with the simultaneous inversion of space and time, leaves the laws of physics intact. The CPT theorem is now recognized as one of the most fundamental theorems in physics.

In the mushrooming field of molecular biology, new discoveries came swiftly. In 1958 Severo Ochoa and Arthur Kornberg shared the Nobel Prize for the artificial production of nucleic acids with enzymes. Then in 1960, using x-ray diffraction techniques, John C. Kendrew and Max Perutz determined the structure of myoglobin and hemoglobin, respectively. In the same year, Jacques Monod and François Jacob proved the existence of messenger RNA, and a year later Robert W. Holley produced transfer RNA, the molecule that actually produces proteins. Marshall W. Nirenberg began breaking the genetic code locked in DNA when he showed that the UUU (uridylic acid) triplet of three bases in a row was the code for the amino acid phenylalanine. And in 1962 Francis H. C. Crick, Maurice Wilkens, and James D. Watson received the Nobel Prize for their determination of the molecular structure of DNA. The concept of a code for life had become reality, with a future of promise and threat from genetic engineering.

But from the point of view of the Bureau, two developments of central importance to basic measurement standards were the most important advances in physics during the period. The first of these was the production by Theodore H. Maiman of the pulsed ruby laser.<sup>23</sup> Based on a fundamental paper by James P. Gordon, Herbert J. Zeiger, and Charles H. Townes on the maser, this work would lead to a host of other types of pulsed and continuous-wave lasers, making possible unparalleled applications in metrology.<sup>24</sup>

<sup>23</sup> T. H. Maiman, "Stimulated Optical Radiation in Ruby," *Nature* 187 (1960): 493-494.

<sup>24</sup> J. P. Gordon, H. J. Zeiger, and C. H. Townes, "The Maser—New Type of Microwave Amplifier, Frequency Standard, and Spectrometer," *Physical Review* 99 (1955): 1264-1274.

The other development was the work of Brian D. Josephson at the Cavendish Laboratory of Cambridge University. In a purely theoretical investigation of electron tunneling through an insulator that separated two superconductors, Josephson, while still a graduate student, showed that a voltage between the superconductors should produce an alternating current across the insulator.<sup>25</sup> The frequency of the current was predicted by a remarkably simple equation. The frequency was simply proportional to the voltage, with the proportionality constant being twice the ratio of two fundamental constants: the electronic charge and Planck's constant. There were thus two uses for the effect. One was the determination of the ratio of the two constants directly in terms of the basic standards of frequency and voltage. The other—which is really the inverse of the first—was to develop a measurement standard for voltage based only on the basic standard for frequency (the most accurate measurement known to science) and the ratio of the two constants.<sup>26</sup> It was another example of using a natural phenomenon as the basis for the realization of a unit of measurement. On January 1, 1990, a new reference standard for the volt based on the Josephson effect was adopted internationally.

## THE BUREAU

Well on its way to implementing the welcome changes inspired by the Kelly Committee Report and, to some degree by the sputniks, the Bureau was about to enter its own "golden age." In the period from 1957 to 1964, its history, like that of the rest of science, did not mirror the growing turbulence of the times. Rather it was to be a time of great growth for the Bureau in which the character of its work was to change significantly. By the end of the period, all the recommendations of the Kelly Committee Report would be accomplished. No longer would transferred funds be the dominant source of financial support. Appropriations would rise dramatically, albeit insufficiently to permit the Bureau to carry out all that was demanded of it. New, talented, younger staff would be added. Most significantly, the character of the work would change, becoming more basic and more fundamental with a substantial theoretical component, a striking departure from its historical condition. Construction of a spacious modern home with several major new facilities—an immense mechanical testing facility, a linear accelerator for electrons, a nuclear research reactor—would be under way in Gaithersburg, Maryland. The Bureau would undertake a new and crucially important program on the production, analysis, and dissemination of scientific data. Most importantly, its scientific productivity would flourish.

These changes did not take place without trauma. Significant reorganization of divisions occurred, and new divisions were formed. This reorganization was accompanied by the replacement of old leaders with new, young ones. Mostly—especially at the

<sup>25</sup> B. D. Josephson, "Possible New Effects in Superconductive Tunnelling," *Physics Letters* 1 (1962): 251-253.

<sup>26</sup> The use of the Josephson effect as a voltage standard is dependent on a further, but related, property of the effect. If, in addition to a direct voltage, an alternating voltage is applied across a superconductor-insulator-superconductor junction, then at frequencies which are sub-multiples of the above defined frequency, the voltage-current curve of the junction shows plateaus at constant voltage.



division chief level—this replacement was done when retirement provided the opportunity. Even so, potential replacements from within were often passed over in favor of new persons from outside or younger leaders from inside, inevitably causing some resentment. New programs were undertaken, important established programs strengthened, and some established programs stopped or curtailed.

Underlying all this was a yearning by Director Astin for a statement of the Bureau's mission, a definition of the Bureau's place in the economic and social fabric of the Nation. This quest produced a series of statements of the Bureau's role and eventually led to an even more important development. Despite all the programmatic changes, the organizational structure of the Bureau remained stable through most of the period. Then in 1964, partly as a result of the quest for the definition of a role and partly as the result of an analysis by a second Kelly Committee of the role of the Department of Commerce in science and technology, the Bureau would undergo the first major structural change in its history.

### **Budget Matters**

The key to all these changes was an increase in direct appropriations, almost certainly brought about by the effect of the 1957 launch of the sputniks. During the previous seven years, Bureau appropriations had actually decreased.<sup>27</sup> Appropriations in 1950 had totaled \$8.8 million; they dropped to a low of \$6 million in 1954, then began to rise, reaching \$8.75 million in 1957. The next seven-year period was to prove greatly different. By 1964, appropriations had grown to \$28.7 million, more than three times the 1957 appropriations. While substantial and surpassing the increases for research and development described in the preceding section, these increases lose some of their impact when the funding history is examined in more detail. The Bureau had been starved for funds since 1950, thus the gains after 1957 were doubly welcome.

The decreasing-increasing course of Bureau funding was mirrored by staffing levels, although the numbers are misleading. Bureau employment reached a peak of 4852 in 1953, though only 1132 were supported by direct appropriation. With the divestiture of the ordnance divisions, total employment dropped precipitously to about 2800. By 1957, total employment was 3024, with 1182 supported by the direct appropriation. Then began a steady climb that in 1964 brought the total level of permanent staff to 3905, with 2043 supported by the direct appropriation. By this time, the staff at Boulder had grown to 1230.<sup>28</sup>

<sup>27</sup> The figures given here are for direct appropriations for research and development. The appropriation total for each year defines the base to which the next year's increases (or decreases) are made and defines the monies available for the Bureau to carry out research and development for its measurement and standards responsibilities. It does not include special one-time appropriations for the purchase of equipment, maintenance and plant services, or the construction of facilities, which can be substantial—the cost of the Gaithersburg facilities was over \$100 million. It also excludes funds from other agencies and income from calibrations, the sales of standard samples, and the reimbursement for administrative services, except as noted in the text. All figures are given in current dollars. Conversion to constant dollars does not change any of the conclusions drawn. Later in the period there were special non-base appropriations for the Civilian-Industrial Technology program and from a Special Foreign Currency Program.

<sup>28</sup> See Appendix G.

These numbers do not represent all the persons working in the Bureau laboratories. For example, in 1964 the total NBS population was 4557, the number above full-time employment being composed of intermittent and temporary employees, consultants, students, teachers, research associates, and guest workers.<sup>29</sup>

The effect of the sputniks was not felt immediately. Because the Government's fiscal year ran from July 1 to June 30, the sputniks occurred in the 1958 fiscal year. Appropriations for that year were made before July 1, 1957. Thus, *Sputnik I* was launched after the budget for FY 1958 had already been passed. Moreover, since budget hearings were held in the spring, budget documents were always prepared in the previous fall. By the fall of 1957, the budget documents for FY 1959 had already been completed. Since, as we have seen, Eisenhower was against crash programs and, in addition, did not feel that the sputniks offered any threat, those budget requests for 1959 were not changed. But the Nation could not stand to be in second place, and the Congress wanted action. In particular, the House Appropriations Committee, under the sympathetic Prince H. Preston of Georgia, wanted to give NBS more money. As the committee well knew, Astin could not ask for more than the administration permitted and so had to defend a smaller budget than Congress would have approved. In early 1958, the Bureau requested an increase of \$2.07 million for FY 1959. Preston deftly drew out that the original Bureau request was for an increase of approximately \$3.5 million, but that this amount had been reduced by the department. Having a little fun at the expense of Astin and the department, Preston asked:

MR. PRESTON: It is not likely that you would have materially altered this budget had sputnik been launched at that time; is it?

DR. ASTIN: I doubt that it would have been materially changed.

MR. PRESTON: There seems to be general agreement between the Department, yourself, and the Bureau of the Budget on this?

DR. ASTIN: Yes, sir.

MR. PRESTON: If the Congress approves the amount that you have requested, in toto, will you essentially be able to fulfill your mission as the Bureau of Standards?

DR. ASTIN: We will not be doing all of the things we should be doing but it is an important first step.<sup>30</sup>

---

<sup>29</sup> These figures come from the following sources, respectively: Kelly Committee Report: 105; MFP Appendix H; House Committee on Appropriations, Subcommittee on Department of Commerce and Related Agencies, *Department of Commerce and Related Agencies Appropriations for 1958: Hearings Before a Subcommittee of the Committee on Appropriations, House of Representatives*, 85th Cong., 1st sess., National Bureau of Standards, 12 March 1957: 166; Annual Report, 1964: 236; House Committee on Appropriations, Subcommittee on Departments of State, Justice, and Commerce, the Judiciary, and Related Agencies *Appropriations, Departments of State, Justice, and Commerce, the Judiciary, and Related Agencies Appropriations for 1965: Hearings Before a Subcommittee of the Committee on Appropriations, House of Representatives*, 88th Cong., 2d sess., National Bureau of Standards, 21 February 1964: 588.

<sup>30</sup> House Committee on Appropriations, Subcommittee on Department of Commerce and Related Agencies, *Department of Commerce and Related Agencies Appropriations for 1959: Hearings Before a Subcommittee of the Committee on Appropriations, House of Representatives*, 85th Cong., 2d sess., National Bureau of Standards, 23 April 1958: 420-423.

Later in the same hearings the subject of high-temperature measurements came up, led by Congressmen Daniel J. Flood of Pennsylvania and Sidney R. Yates of Illinois. It was believed, or perceived, that the Soviet Union had far greater capabilities for measuring high temperatures than did the Bureau—6000 °C as contrasted to 3000 °C. Astin explained that in order to extend the range of measurements, a new facility would have to be built. Mr. Yates asked:

MR. YATES: Why do you not ask for the facility then?

DR. ASTIN: I hope that ultimately we will be permitted to ask for it.

MR. FLOOD: Permitted to ask for it?

MR. YATES: Who is preventing you from asking for it?

DR. ASTIN: We have prepared an analysis of major needs, at the request of the Secretary of Commerce, and this is under consideration.

MR. YATES: And in the meantime you are falling behind every day?

DR. ASTIN: Our requests were rather substantial.<sup>31</sup>

It was clear that the way was open for significant budget increases. Congress would certainly not stand in the way. That year the Congress approved the full \$2.07 million increase. Next year the Bureau asked for an increase of \$6 million and received \$5.75 million. In the two years following the sputniks, the Bureau appropriation increased from \$9.73 million to \$17.25 million. With Astin explaining how the demands on the Bureau exceeded the Bureau's ability to fulfill them and comparing Bureau capabilities to those of the Soviet Union when possible and strategically advantageous, the budget continued to increase, although not as greatly as the demands. By FY 1964, the Bureau appropriation was \$28.7 million.

In 1957 the Bureau, of course, did not know that its appropriation would expand in the manner it did. Moreover, one of management's greatest concerns was to bring transferred funds into balance with appropriated funds in the manner recommended by the Kelly Committee. There was no evidence that this balance would occur of its own accord. Indeed, in fiscal years 1956-1958 the ratio of transferred to the total of transferred plus appropriated funds remained relatively constant at 63 percent to 65 percent. To try to arrive at a policy on transferred funds, Nicholas E. Golovin, then associate director for planning, undertook a study of work performed for the Bureau of Aeronautics (BuAer) as representative of other-agency work in general.<sup>32</sup> The BuAer was a large client of the Bureau, with a \$1.43 million program spread through nine of the Bureau's divisions. Golovin found that 26 percent of the BuAer funds were "convertible" and the remainder "nonconvertible." In accordance with definitions contained in the Kelly Committee Report, the term convertible meant that the work was such that the Bureau could justify it as part of its measurement and standards

---

<sup>31</sup> *Ibid.*, 433.

<sup>32</sup> Memorandum, N. E. Golovin to A. V. Astin, "Bureau of Aeronautics Programs," August 2, 1957. (NARA; RG167; Astin file; Box 17; Folder Golovin Correspondence Relating to NBS Programs and Administrative Problems, 1956-1958)

mission hence desirable because it added to basic Bureau capabilities. The nonconvertible work was quite different. The Bureau could not justify it as part of its basic mission; it was purely a service to the agency requesting it. But the Bureau went a step beyond the Kelly Committee Report. Not only would it undertake to carry out the desirable convertible work for other agencies, it would, in fact, seek direct Congressional appropriations to carry out the work, much as was done with the conversion of the Interservice Radio Propagation Laboratory into the Central Radio Propagation Laboratory (CRPL).

Golovin suggested a policy statement for the acceptance of work of other Federal agencies. The policy stated that NBS would not undertake industrial-type product or device development, evaluation, or testing work unless [1] there were a national emergency, [2] there were no "alternative source of capabilities . . . inside or outside the federal government," [3] the Bureau had been assigned a central mission for doing the work, or [4] if "test and evaluation work is limited in extent or duration, and is definitely subordinated to . . . developing data and/or test procedures of sufficient interest to warrant publication. . . ." If the third or fourth conditions applied, it was understood that the work would eventually be financed by direct appropriations.<sup>33</sup>

Upon receiving this memorandum, Astin appointed a committee under the chairmanship of Robert D. Huntoon to study the application of this policy, first to specific divisions and then to the rest of the Bureau.<sup>34</sup> After considering a number of options, the committee came up with a remarkable proposal.<sup>35</sup> All the nonconvertible other-agency work would be carried out in a separate organizational unit with the tentative title Institute for Applied Science. Reporting to an associate director for applied science, "the institute would be part of NBS with Civil Service Commission employees, but would be financed entirely from transferred funds and would not ask for Congressional support." An important point made by the committee was that the institute would be similar to the Diamond Ordnance Fuze Laboratory before its divestiture by the Bureau. Administrative services would be shared, employees of the "regular" Bureau could occasionally go to work in the institute, and special NBS capabilities (such as vacuum-tube fabrication) could be utilized via work orders. Convertible transferred-funds work would be carried out as usual except that steps would be taken to convert it to appropriated-funds work.

<sup>33</sup> Memorandum, N. E. Golovin to A. V. Astin, "Working Fund Work Policy Statement," September 30, 1957. (NARA; RG167; Astin file; Box 17; Folder Golovin Correspondence Relating to NBS Programs and Administrative Problems, 1956-1958)

<sup>34</sup> Memorandum, A. V. Astin to Committee Members, "Special Study of NBS Programs Supported by Other Federal Agencies," October 16, 1957. (NARA; RG167; Astin file; Box 17; Folder Golovin Correspondence Relating to NBS Programs and Administrative Problems 1956-1958). The members of the committee were R. D. Huntoon, associate director for physics; N. E. Golovin, associate director for planning; I. C. Gardner, chief, Optics and Metrology Division; W. Ramberg, chief, Mechanics Division; I. C. Schoonover, chief, Mineral Products Division; F. B. Silsbee, chief, Electricity and Electronics Division; and Carroll C. Stansbury, chief, Electronic Instrumentation Section. Later, Dean Judd, the Bureau's expert on color measurements, was added to the committee.

<sup>35</sup> Memorandum, R. D. Huntoon, chairman, Special Committee on Programs Supported by Other Agencies to A. V. Astin, "Report of Committee," January 20, 1958. (NARA; RG 167; Astin file; Box 18; Folder Testing by NBS 1952-58)

All in all, the proposal to establish an institute whose sole purpose was to conduct—with transferred funds—scientific work that the Bureau would not carry out under its basic measurement mission was a strange proposal indeed. Only a few years earlier the Bureau had such an institute in the Diamond Ordnance Fuze Laboratory. Admittedly, under the pressure of the Korean emergency, the laboratory had grown so big that the Bureau had to divest it lest the Bureau lose its identity. Now the committee was proposing to create another such institute. As the committee pointed out, the clear identification of this entity as separate and bearing only an administrative relation to the Bureau would permit complete budgetary separation between direct appropriations and convertible transferred funds on the one hand, and nonconvertible transferred funds on the other. Perhaps it was felt that this clear separation would protect the Bureau's measurement mission. The separation would be a sign to all that the Bureau was doing this work purely as a service to other agencies and would not do it otherwise, except in a national emergency, under direct orders, or if no other organization was capable of doing the work.

Whatever the reasons for the proposal, it does not appear to have led anywhere. In fact, the rising appropriations decreased the need to rely on transferred funds. While appropriations rose to \$28.7 million in 1964, transferred funds were reasonably constant between 1957 and 1964, averaging \$15.26 million per year—a maximum of \$17.88 million in 1964 and a minimum of \$13.22 million in 1961. Indeed, in 1960, for the first time since before World War II, appropriated funds exceeded transferred funds, being 53.8 percent of the total. By 1961, transferred funds were less than 40 percent of the total and remained near that figure for the rest of the period. There is also some evidence that the character of the transferred-funds work was changing. The criteria applied to the acceptance of transferred-funds work in 1957 were that it have a close relationship to the basic functions of NBS, show a prospect of producing results of general value to science, or that it could not be undertaken as effectively elsewhere.<sup>36</sup> But no one knew the optimum amount of transferred-funds work, or even if there was an optimum amount. Hence the subject continued to be discussed by Bureau staff members in memoranda to their superiors in the Bureau and in the department.<sup>37</sup> Despite all this study and communication, something like the policy as stated in Golovin's original memorandum remained the guiding policy on transferred-funds work. The subject would continue to concern Bureau management for the remainder of this history.

---

<sup>36</sup> Report, "Analysis of Program Conversion." (NARA; RG 167; Astin file; Box 20; Folder Correspondence 1958). This unsigned, undated eight-page document appears to be an analysis for Bureau management of transferred funds from 1947 to 1958. The context indicates that it was written in 1958.

<sup>37</sup> Memoranda: N. L. Christeller to A. V. Astin, "Conversion Policies," January 27, 1962; Under Secretary E. Gudeman to A. V. Astin, "Conversion Program in National Bureau of Standards," January 18, 1962; L. M. Branscomb to A. V. Astin, "Transferred Fund Policies," October 30, 1961. (NARA; RG 167; Astin file; Box 15; Folder Transfer of Funds)

In 1960, funds from an unusual source became available for the Bureau to carry out a part of its program.<sup>38</sup> Through its Commodity Credit Corporation (CCC), the United States sold surplus agricultural commodities to various nations and was paid by the purchasing country in the local currency. By the terms of the law governing these sales, the United States was obligated to spend these funds in the purchasing country. The money could be used for such essential expenses as support of the U.S. embassy.<sup>39</sup> In some cases the sales exceeded these necessary expenses and a surplus of funds in the local currency accrued to the CCC account. The NSF requested that the Bureau of the Budget permit various Government agencies to use these funds to support research in the foreign country to further those agencies' programs. Such permission was granted, and thus was born the Special Foreign Currency Program, or, less formally, "PL-480 money."

However, by the terms of PL-480, the agencies could only use these surplus funds if the Congress appropriated U.S. dollars to the agencies for "purchase" of the funds from the CCC. In effect, U.S. funds were transferred from the Treasury's general account to the CCC account. The net result was to use surplus commodities for the purchase of research services, but the appropriations committees remained in charge of the agencies' funds.

The Bureau, with excellent knowledge of the scientific work in other countries and seeing a way of carrying out work that it could not do itself, was naturally interested in obtaining PL-480 money. The funds did not permit the addition of staff, but they permitted the support of foreign workers in fields where knowledge was important to the Bureau program and, in a roundabout way, permitted more foreign travel than was possible under the chronically inadequate foreign-travel allotment. In 1960, the Bureau asked for \$5.17 million for work in Spain, Yugoslavia, Poland, Israel, India, and Pakistan, but received nothing. In 1961, NBS asked for \$5 million, now omitting Spain from its list of countries, but the Joint House and Senate Conference Committee deferred the appropriation pending further studies. In 1962, proposing projects only in Israel, India, and Pakistan, it asked for and received \$1 million. In 1963 and 1964, the Bureau again asked for \$1 million, and received half the requested amount. The work included such studies as the calculation of atomic spectra (Israel), the propagation of electromagnetic waves in the earth (India), standard reference materials (Pakistan), and translations—particularly from the Russian literature—on highly specialized topics of little interest to U.S. publishers. It was a useful program, expanding the Bureau's international activities. The Bureau continued to receive funds from this source into the 1980s, when the CCC funds in excess were essentially depleted.

---

<sup>38</sup> House Committee on Appropriations, Subcommittee on Department of Commerce and Related Agencies, *Department of Commerce and Related Agencies Appropriations for 1961: Hearings Before a Subcommittee of the Committee on Appropriations, House of Representatives*, 86th Cong., 2d sess., National Bureau of Standards, 13 January 1960: 264-281.

<sup>39</sup> *Agricultural Trade Development and Assistance Act of 1954, U.S. Statutes at Large*, 68 (1954): 454.

## An Evaluation and a Status Report

Doubtlessly pleased with the results of the Kelly Committee Report in 1953, Secretary Weeks, as one of his last acts at Commerce, in late 1958 asked the National Academy of Sciences to carry out a similar study of science and technology in the whole Department of Commerce, not merely on the Bureau alone. Weeks requested that a committee be appointed "to undertake an up-to-date evaluation of the functions and operations of the Department of Commerce in relation to present national needs,"<sup>40</sup> and Detlev W. Bronk, then president of the Academy, appointed Mervin J. Kelly as chairman of the committee.<sup>41</sup> Their report, *The Role of the Department of Commerce in Science and Technology*,<sup>42</sup> was delivered on March 2, 1960, to then Secretary of Commerce Frederick H. Mueller, the second secretary to hold the office after Weeks had commissioned the second Kelly study shortly before he returned to private life.

The objective of the study was "to evaluate the functions and operations of the Department of Commerce to insure that it is fulfilling its responsibilities in the interest of science and technological progress."<sup>42</sup> For this purpose the committee studied all the agencies of the department that had some bearing on science.<sup>43</sup> In addition, the committee investigated the overall management of science at the secretarial level. In its analysis, the committee found that in comparison with other nondefense science and technology institutions, financial support in the Department of Commerce was relatively inadequate and had not progressed as rapidly as that of other institutions. Most important, the committee found that "the explanation lies largely in Commerce's organization structure and personnel at the administrative level."<sup>44</sup> The administration of the seven agencies in the study was divided between two "assistant secretarial offices." These assistant secretaries had other competing responsibilities and, in addition, the offices had not been "filled . . . by men with background in science and technology and understanding of the operations and needs of research and development." To rectify this situation the committee recommended the formation of "an assistant secretaryship for science and technology" to provide "professional leadership at the top administrative and policy levels." It was the only department-wide recommendation made by the committee.

---

<sup>40</sup> Letter, D. W. Bronk to Secretary of Commerce F. H. Mueller, March 2, 1960. This is the cover letter for the committee report.

<sup>41</sup> The other members of the committee were Horace R. Byers, Michael Ference, Jr., Paul M. Frye, Frank W. Herring, Augustus Kinzel, H. A. Leedy, Dale F. Leipper, C.G. Suits, and Abel Wolman.

<sup>42</sup> *The Role of the Department of Commerce in Science and Technology: A Report to the Secretary of Commerce by a Special Advisory Committee of the National Academy of Sciences* (Washington, D.C.: NAS-NRC, 1960): 3. Hereafter referred to as the Second Kelly Committee Report.

<sup>43</sup> Besides the National Bureau of Standards, the agencies were the U.S. Coast and Geodetic Survey, Maritime Administration, Patent Office, Bureau of Public Roads, Office of Technical Services, and Weather Bureau. The Bureau was by far the largest, with appropriated expenditures equal to the combined scientific expenditures of all the other agencies.

<sup>44</sup> Second Kelly Committee Report: 6.

The recommendation was adopted, the position established, and in May 1962 its first occupant, J. Herbert Hollomon, was installed. Hollomon was a forceful and dynamic research manager-metallurgist from the General Electric Research Laboratory who would have a profound effect on the organization, programs, and manner of operating at the Bureau.

Earlier, in 1958, at about the time Astin learned that Secretary Weeks had requested the formation of an evaluation committee, he had been discussing the major needs of the Bureau with Under Secretary Walter Williams.<sup>45</sup> At the request of the under secretary and doubtless spurred by the impending formation of the second Kelly Committee, Astin prepared a study paper for use by the secretary of commerce in planning for Bureau activities.<sup>46</sup> Along with a three-page memorandum for the secretary, the study paper provided an analysis of both the legislative and the financial needs of the Bureau. In it Astin clearly pointed out that certain very important activities carried out by the Bureau did not arise directly from its organic act, but were carried out because of frequent ad-hoc assignments or other-agency arrangements. These activities needed a base of mission statements with legal impact. For example, the functions of the CRPL were not clearly defined, leading other agencies to try to duplicate some of them. Astin felt that an Executive Order, perhaps initiated by the science advisor, would simplify the operation of the CRPL for both the Bureau and the Department of Defense.

Other activities in which the Bureau's role required greater clarification were Boulder's Electronic Calibration Center, under construction with appropriated funds at the request of the DOD but without firm commitment from Defense for its support; the Building Technology Division, which was becoming a central government building-research activity with no authoritative definition of its scope and objectives; the Cryogenic Engineering Division, set up with AEC funds and subsequently transferred to the Bureau when AEC needs diminished; the Data Processing Systems Division, which was becoming a sort of central government service organization for computers, but without an authoritatively defined mission; the Applied Mathematics Division, which was in much the same situation; and the National Hydraulics Laboratory, which had never received sufficient support to become a truly national research facility and whose facilities were being duplicated and surpassed in other agencies.<sup>47</sup>

Astin made two other points in this administrative portion of his study. Both had to do with the difficulty of hiring and retaining staff, particularly at the higher levels. Government pay scales were simply not high enough to compete with the private

<sup>45</sup> Memorandum, A. V. Astin to W. Williams, "Major Needs of the National Bureau of Standards," March 3, 1958. (NARA; RG167; Astin file; Box 36; Folder "A"-NBS Functions)

<sup>46</sup> "Study Paper on Major Needs of the National Bureau of Standards," February 25, 1958. (NARA; RG167; Astin file; Box 36; Folder "A"-NBS Functions). The first page of the study paper is unfortunately missing from the record.

<sup>47</sup> A national hydraulic laboratory facility was authorized on May 14, 1930. It was to have been a facility available to all agencies of the Government to obtain fundamental data in hydraulic research and engineering. (*Bureau of Standards, hydraulic laboratory to be established, U.S. Statutes at Large*, 71 (1930): 327)



sector, and Astin requested an increase in the number of PL-313 positions allocated to the Bureau.<sup>48</sup> In addition, he strongly recommended legislative requests that would increase the general pay scales of scientists.

In a long portion of the study Astin asked for funds for specific equipment, facilities and programs. Stating that this was not an exhaustive inventory he listed twenty-three specific items, ranging from \$81 million for new facilities at Gaithersburg to \$250 000 in yearly operating costs for a program in operations research. While most of the requests were the type normally made by research directors, three illustrate some of the new directions the Bureau was taking and the change in its character. There was a request for \$4.7 million for a high-intensity linear electron accelerator and \$4 million for a companion research nuclear reactor. These two facilities would in due course be realized, and the Bureau would become a leader in their use.

But one item more than any other illustrated how the nature of the Bureau's work was changing in 1958. In item number 6, the Bureau requested \$500 000 as yearly operating costs for theoretical studies. Stating that "one of the current weaknesses of the Bureau's programs is inadequate highly specialized attention to the theoretical aspects of experimental work . . .," Astin proposed to "establish strong theoretical groups at both Washington and Boulder on a sufficiently large scale to attract the desired and needed talent."<sup>49</sup> No such autonomous groups would be formed, but theoretical work was rapidly becoming a strong—if decentralized—component of Bureau activities.

As did the first Kelly Committee, the second carried out an intensive, division-by-division investigation of the Bureau. It gave the Bureau high praise, writing "the Bureau represents an important and permanent scientific resource of government, and should be given the support warranted by so valuable an asset that insures the maintenance and enlargement of its scientific strength and effectiveness."<sup>50</sup> More

---

<sup>48</sup> Enacted on August 1, 1947, Public Law 313 (*War and Navy Department, professional and scientific service, U.S. Statutes at Large*, 61 (1947): 715) established a new class of Civil Service positions within the War and Navy Departments. To "effectuate those research and development functions, relating to the national defense . . .," these positions could be granted by the secretaries of the departments, upon approval by the Civil Service Commission, without competitive examination. The law specified the number of positions allotted to each department, as well as the minimum and maximum salaries permitted. The salaries were higher than those for the GS-15 level, the normal top of the grade. From time to time amendments to the act extended the authority to other agencies, revised the number of positions allotted, and the salary range.

In a similar manner, Public Law 429 (*Classification Act of 1949, U.S. Statutes at Large*, 63 (1949): 954) specified the number of positions for the whole Civil Service in grades GS-16, GS-17, and GS-18—the so-called "Super Grades." Again periodic revisions in number and salary were made. In 1965, the Bureau had 39 appointees in GS-16, and 29 in GS-17. It also had 12 under Public Law 313. Memorandum, G. R. Porter to A. V. Astin, June 14, 1965. (NARA; RG 167; Astin file; Box 20; Folder Correspondence 1965)

<sup>49</sup> Study Paper: 8.

<sup>50</sup> Second Kelly Committee Report: 87.

important, as part of its investigation, the committee asked Astin to prepare for them a statement of the missions of the Bureau, and what resulted was the first clear statement during Astin's tenure of these missions.<sup>51</sup> Included as an appendix to the committee report, the statement won high praise from the committee, which wrote: "[the paper] gives evidence of a clarity of vision of the Bureau's place in government and in the nation's scientific and industrial communities."<sup>52</sup>

The statement was based largely on the 1958 study paper Astin had written for the secretary but with only an abbreviated list of desired projects and considerably more on the mission of the Bureau. Using the 1950 version of the Organic Act as the basis for his discussion of the Bureau's mission, Astin pointed out that the legal functions of the Bureau were very broad and permitted "almost any sort of technical activity" but were not much help in setting priorities.<sup>53</sup> Astin looked at the mission statement as useful in setting priorities. After a cogent discussion of the functions listed in the enabling legislation, Astin arrived at a single statement for the Bureau's primary mission:

The National Bureau of Standards seeks to provide the central basis for a self-consistent and uniform system of physical measurement throughout the United States.<sup>54</sup>

Having such a statement, the relevance of a program to a "particular measurement problem and its importance to scientific and technological industrial progress" may be judged and hence priorities set.<sup>55</sup>

But this statement did not encompass all the activities of the Bureau. In particular, it did not come to grips with the other-agency problem. Here Astin felt an obligation to perform technical services for other agencies but only to the extent that such work did not interfere with the primary mission. There would be no going back to the ordnance development days. Moreover, if a particular task were to be substantial and continuing, a formal assignment of responsibility would be desirable, as Astin had already proposed in his study paper. Again he stressed the need for better definitions of the missions of CRPL and other Bureau programs. In smaller, miscellaneous projects for other agencies, Astin's policy was to give preference to those jobs where the Bureau had some unique competence or which enhanced its measurement-standards competence. Finally, Astin noted a very important point. In the field of industrial standards, codes, and specifications, the Bureau had no primary responsibility for the development or promulgation of these standards, but it made its competence available to the organizations that had the responsibility.

---

<sup>51</sup> Minutes of associate director meetings, November 3 and November 5, 1958, and November 6, 1959. (NARA; RG167; Astin file; Box 29; Folder Old—AD Minutes). This mission statement was worked on by the associate directors in late 1958 and finished in late 1959 for publication in the Annual Report, 1960.

<sup>52</sup> Second Kelly Committee Report: 83.

<sup>53</sup> *Ibid.*, 97.

<sup>54</sup> *Ibid.*, 98.

<sup>55</sup> *Ibid.*

The committee took good note of Astin's paper. Their recommendations reflected the desires of the Bureau. The committee called for: yearly expansion of 15 percent in the measurement standards area (a rate that could not long be sustained); rapid completion of the Gaithersburg installation; an Executive Order for the CRPL; special committees of scientists and engineers to review the scope and activities of the Cryogenic Engineering Laboratory, the National Hydraulics Laboratory and the Building Technology Division; appropriated funds to be used for measurement and standards activities of broad national interest; a substantial increase in the number of PL-313 positions; more effective technical advisory committees; and an analytical review and report for the Statutory Advisory Committee, by the director, of the Bureau's various activities for other agencies. Not all of these recommendations would be carried out, but they were an eminently reasonable set.

The interest in a well-articulated mission statement did not end when Astin framed one for the second Kelly Committee. On September 9, 1960, the Bureau issued a mission statement and published it in its annual report for 1960. An expansion of what was provided for the committee and less pedagogical in tone, the statement was built around the measurement-standards functions of the Bureau but did not contain the condensed single-sentence version noted above. Nor did it come to grips with the Bureau's special responsibilities, instead promising that the Radio Propagation Laboratory, the National Hydraulics Laboratory, the data processing systems program, cryogenic engineering, building technology, and fire research would be "dealt with in later separate statements."<sup>56</sup>

In cryogenic engineering and building technology, the special statements would take the form of reports of the National Academy of Sciences. Following the recommendations of the Kelly Committee, the Bureau asked the academy to appoint committees of experts to "determine the scope of the Bureau's responsibilities in these areas." The academy did so, appointing an ad-hoc committee to investigate the cryogenic-engineering area and a committee from the Building Research Advisory Board of the National Research Council (NRC) to investigate the building-technology area. The two reports were delivered in 1962, the cryogenics on January 15 and the building technology on May 21.<sup>57</sup> Both reports, though each with a different emphasis, cautioned that the Bureau should not compete with industry in the development of proprietary products but found that the Bureau did have a role in these areas.

The cryogenics panel in effect wrote a mission statement for the Bureau's cryogenics work. Pointing out that the competence of the Bureau was utilized in reinforcing

---

<sup>56</sup> Study Paper: 4-5; Second Kelly Committee Report: 95; Annual Report, 1960: 150.

<sup>57</sup> "Report of the Ad-Hoc Cryogenic Engineering Panel," Dr. Clyde McKinley, chairman, January 14, 1962 (Washington, D.C.: National Academy of Sciences-National Research Council, 1962). (NARA: RG167; Astin file; Box 21; Folder NAS/AVA-1953-1969); "A Program for Building Research in the United States, a Report for the National Bureau of Standards by a Special Advisory Committee of the Building Research Advisory Board," Richard G. Folsom, chairman, May 21, 1962. Publication 994 (Washington, D.C.: National Academy of Sciences-National Research Council, Building Research Advisory Board, 1962). (History Project File, Chapter 4, Folder Building Res. Ch. 4). See also Bascom W. Birmingham, "Program of the Cryogenic Engineering Laboratory Division," February 1964. A "white paper" courtesy of the author. (History Project File, Chapter 4, Folder Birmingham White)

the capabilities of other Government agencies to further the national need in cryogenics, the panel noted that in carrying out this function the agency's "activities are broadly basic in character, in keeping with the primary measurement mission of the Bureau." The committee then listed five specific types of activities, all concerned with providing information on cryogenic engineering, including the maintenance of a National Cryogenic Data Center and the furnishing of advisory and consultative services to other government agencies and the general public. It is clear that the cryogenics panel saw a useful role for the Bureau in the cryogenics area.<sup>58</sup>

The Building Research panel made a very different recommendation. It recommended that there be established a National Institute of Building Research with the mission of "stimulating and sustaining a correlated and continuing national program of building research," that the Institute be organized under the Bureau, and that the Bureau's research activities be incorporated in the Institute. It was a wide-ranging recommendation but showed clearly that there was an important role for the Bureau in building research.<sup>59</sup>

However, Astin did not accept the recommendation of the panel. He wrote to Hollomon, "I am skeptical that a National Institute of Building Research, established within the NBS and subordinate to it, could effectively attain the full stature and importance which the recommended program elements demand. . . . It should be essentially on the same reporting level as NBS."<sup>60</sup> How Astin proposed to deal with the special mission for building research is discussed in a later section of this chapter.

Fire research was in somewhat the same state as building research. An NAS-NRC panel, under joint sponsorship of the U.S. Forest Service, the DOD, the NSF, and the Bureau, studied the fire problem during several weeks in the summer of 1961 and recommended that a fire group should be formed in the Federal Government. This group would continually assess the fire program in the whole Nation and "arrange for the execution of work not now adequately supported."<sup>61</sup> The group should have a full-time director and a full-time technical staff. A budget of \$3 million was suggested as a start, rising to perhaps three times that amount. It is not difficult to think of this as an institute as well. Indeed, the recommendations were referred to the Federal Council for Science and Technology (FCST), which gave this responsibility to the Department of Commerce. The Bureau was then designated "a central agency for fundamental fire research in the physical sciences . . ." and, with funds provided by the DOD and the Office of Civil and Defense Mobilization, it began to support fundamental research in

<sup>58</sup> "Report of the Ad-Hoc Cryogenic Engineering Panel," 5.

<sup>59</sup> "A Program for Building Research in the United States," 7.

<sup>60</sup> Memorandum, A. V. Astin to J. H. Hollomon, "NAS-NRC report 'A Program for Building Research in the United States,'" February 21, 1963. (DOC; Assistant Secretary for Science and Technology; Accession 40-68B-6087; Box 28; Folder National Bureau of Standards)

<sup>61</sup> *A Study of Fire Problems: a Study held at Woods Hole, Massachusetts, July 17 to August 11, 1961 under the guidance of the Committee on Fire Research of the National Academy of Sciences-National Research Council, Division of Engineering and Industrial Research* (Washington, D.C.: NAS-NRC, 1961) NAS-NRC publication 949: 1. See also NAS Annual Report, 1961-1962: 79-80.

other laboratories.<sup>62</sup> Plans were made to form a National Center of Fire Technology to report to Hollomon, but this did not come to pass.<sup>63</sup>

It was not clear to everyone that the Bureau had a role in these areas. On September 25, 1962, eight months after the cryogenics panel report, Hollomon wrote to Astin: "I wish to initiate the necessary steps and come to a decision concerning the Cryogenics Laboratory at Boulder. Further, I think we agree that the work underway there does not fall within the responsibility of the Bureau of Standards. . . . I think it very likely that it may be carried out by private enterprise rather than by government and it is in competition with private enterprise. Thus, I would appreciate your indicating the steps that are necessary for the government to cease operating the Cryogenic Laboratory."<sup>64</sup>

Astin's thoughts on receiving this letter are not known. What happened was that Bureau management, with these two reports in hand, took a different course and rewrote the mission statement extensively. It produced a strikingly different document from that prepared in 1960. On June 20, 1963, Deputy Director Huntoon wrote to the division and section chiefs on the restatement of the mission:

The mission of the National Bureau of Standards is to conduct research and perform essential central national services in the area of physical measurement which are performed with the objective of facilitating the reliable and efficient exchange of quantitative data and of technological products and services in science, engineering, industry and commerce.

The research and services aspects of the mission are considered as equal in priority since neither can exist without the other. Without the service function there is no solid justification for NBS to continue as a Federal research institution. Without the research function the service function cannot be effectively performed. Therefore, both must be emphasized and neither to the detriment of the other.<sup>65</sup>

The document then went on to list eight mission components: direct services, physical measurement standards or measurement systems, standard reference data, standard reference materials (previously called standard samples), engineering measurements and standards, special central responsibilities, general informational research (undirected basic research), and technical services, such as mathematical, instrumental and analytical services.<sup>66</sup>

---

<sup>62</sup> Annual Report, 1960: 109.

<sup>63</sup> "Minutes of the Annual Meeting of the NBS Visiting Committee," May 14, 1962: 4. (NIST RHA; Director's Office file; Box 354; Folder 1962—Visiting Committee)

<sup>64</sup> Memorandum, J. H. Hollomon to A. V. Astin, "Cryogenics Laboratory," September 25, 1962. (NARA; RG 167; Astin file; Box 17; Folder Correspondence re. Senior Appointments)

<sup>65</sup> Memorandum, R. D. Huntoon, deputy director to division and section chiefs, "Revised Mission Statement and Associated Programming Instructions," June 20, 1963: 1. (NARA; RG 167; Astin file; Box 15; Folder Mission)

<sup>66</sup> *Ibid.*, 1-3.

The most interesting of these components was "special central responsibilities." The memorandum states, "The enabling legislation of the Bureau and the stated mission are broad enough to permit either temporary or long term activity in connection with central national responsibilities. . . . When authorized and activated these will be included in one component of the mission, called . . . Special Central Responsibilities."<sup>67</sup> Only three examples of these were listed: radio-propagation research and services, building research, and data-processing-systems research and services. Missing from the list were cryogenic engineering and the National Hydraulics Laboratory. With this new mission, the cryogenic-engineering activities fell under direct services, standard reference data, and engineering standards, so that by redefining the mission, the activities of this program fell under three of the defined mission components, thereby obviating the need for a special mission. The three listed still needed special mission justification.

The analyses of the Hydraulics Laboratory's functions and fate came about in a somewhat different manner. Astin had been concerned for some time about what to do with this laboratory, particularly since the impending move to Gaithersburg made a decision on facilities at the new site imperative.<sup>68</sup> Thus, doubtless at his instigation, in November 1960 the FCST appointed a committee with Astin as chairman to decide the fate of the laboratory.<sup>69</sup> After a few meetings, Astin reported to the FCST on the decisions the committee had reached. The committee recommended that the legislation establishing the Laboratory be repealed, provided that all agencies involved in hydraulics strengthened their basic research programs; it provided a list of recommendations for strengthening basic research in hydraulics; and it recommended that a limited research hydraulics facility be provided for the Bureau at the Gaithersburg site. This was in fact done.

---

<sup>67</sup> *Ibid.*, 3.

<sup>68</sup> Memorandum, C. N. Coates to A. V. Astin, "Advisory Committee Recommendations Regarding National Hydraulics Laboratory," September 8, 1958. (NARA; RG 167; Astin file; Box 16; Folder National Hydraulics Laboratory, Army Corps of Engineers). Authorized in 1930 (*Bureau of Standards, hydraulic laboratory, U.S. Statutes at Large*, 46 (1930): 327) as a laboratory to obtain fundamental data in hydraulics research and to serve as a central Government laboratory in this field, the then-not-inconsiderable amount of \$350 000 was authorized and appropriated for the facilities. However, operating funds commensurate with this broad authority were not provided and the laboratory operated principally on transferred funds. In 1961 it had a staff of fifteen and expenditures of \$69 000 from direct appropriations, and \$109 000 from transferred funds. By comparison, the Navy spent \$1.41 million, the U.S. Geological Survey \$330 000, and the USDA Soil Conservation Service \$1.85 million, only slightly less than half in basic research. The laboratory did regularly publish a directory of all the hydraulics research carried out in the United States and Canada. From 1933 to 1942 these directories were published as the *Bulletin. Series A: Current Hydraulic Laboratory Research in the United States*, from 1947 to 1971 as *Hydraulic Research in the United States*, and from 1974 to 1980 as *Hydraulic Research in the United States and Canada*.

<sup>69</sup> Letter, L. Carmichael, chairman of the Standing Committee of FCST, to A. V. Astin, December 1, 1960. (NARA; RG 167; Astin file; Box 16; Folder FCST Hydraulics Lab. Panel). The committee members in addition to Astin were, A. L. Cochran, Corps of Engineers; L. B. Leopold, U.S. Geological Survey; F. D. Rigby, Office of Naval Research; G. B. Schubauer, National Bureau of Standards; R. J. Seeger, National Science Foundation; T. W. Edminster, U.S. Department of Agriculture; and J. Westrate, FCST Standing Committee.

The Bureau did, however, pick up a new amendment to its organic act on September 7, 1958.<sup>70</sup> Unlike the 1950 revision, it had nothing to do with the basic responsibilities and authority of the Bureau. Rather, along with other similar housekeeping matters, it clarified the secretary of commerce's authority to acquire or lease land for field sites and to undertake the construction of buildings. The law had no effect on the work the Bureau was authorized to carry out and, hence, was of no historical consequence.

### **An Organization Changes**

As with any organization, the Bureau underwent periodic alterations in the makeup of its organization when individuals left for retirement or other reasons, and organizational units were added, subtracted, or had functions modified as the aims of the institution changed. During the period 1957-1964 there were a number of the former type of changes, and many of the latter type as management strove to redirect the nature of the research carried out. However, in these changes the basic line structure of section-division-director was not altered. In 1964, a major change occurred in which a new level of "institute" was added, so that the line structure was now section-division-institute-director.

Along with this new line structure, there was, of course, a support and staff structure, sometimes organized as divisions, sometimes as offices, and sometimes simply by title. One of the most important changes made during the period occurred in 1958, when the position of deputy director was formed. Robert D. Huntoon was the office's first occupant. It is remarkable that in its first fifty-seven years the Bureau had not felt the need for this position. With "fully delegated authority in the direction, coordination, and review of Bureau programs and administration,"<sup>71</sup> the position freed the director from day-to-day operations and allowed him to devote himself to broad policy matters and to contacts with the outside.<sup>72</sup> It was a significant change.

The Office of the Director always had a number of consultants, special advisors, special assistants, and persons with similar functions. Then in 1961, a new position of senior research fellow was created. Similar to the movement in many other research organizations at that time to form a "parallel ladder" recognizing—and paying—scientists as much as managers, this position was to "afford recognition to distinguished scientists and to enable them to do independent research and consultation of a broad character beyond the scope of a particular division."<sup>73</sup> The first holder of one of these positions was Ugo Fano, the Bureau's senior theoretical physicist. By July of

---

<sup>70</sup> *An Act To amend the Act of March 3, 1901, U.S. Statutes at Large*, 72 (1958): 1711.

<sup>71</sup> Annual Report, 1959: 14.

<sup>72</sup> As already discussed in previous chapters, the Bureau had a number of associate directors in several disciplines, including planning, but these positions combined line and staff functions and cannot be considered as true line positions. In 1961, the "Associate Directors were relieved of responsibility for supervision of particular divisions so that they could spend full time in staff work for the Director and Deputy Director." (Annual Report, 1961: 17)

<sup>73</sup> Annual Report, 1961: 17.



Robert D. Huntoon joined the Bureau staff in 1941 as one of the principal scientists working on the development of the radio proximity fuze, a major scientific achievement bearing on Allied victory in WWII. Over the course of his career, Huntoon held many high-level positions at the Bureau, including chief of the Electronics Division, chief of the Atomic and Radiation Physics Division, acting chief of the Central Radio Propagation Laboratory, coordinator of Atomic Energy Commission projects at NBS, director of the NBS Corona Laboratories, and associate director for physics. In 1958, Huntoon was appointed deputy director, becoming the first occupant of the newly created position.

1964, he had been joined by chemist-theoretician Kurt E. Shuler, mathematical statistician Churchill Eisenhart, and James R. Wait, the principal theoretician of the CRPL. All were administratively assigned to the Office of the Director.

This new-found concern for the staff was illustrated by the establishment of awards. The few awards then available were of recent establishment. In 1949, the Department of Commerce had initiated two awards to recognize outstanding performance by members of the staff. These were the Gold Medal award, Commerce's highest honor, conferred upon an employee of the department for "distinguished achievements of major significance to the department and the Nation," and the Silver Medal award, the second highest award of the Department, bestowed for "meritorious contributions of exceptional value to the Department." Each of these consisted of a medal, a lapel emblem, and a certificate. They were naturally highly prized.

Although members of the Bureau staff were frequent winners of these awards, in the first sixty years of its history the Bureau had not instituted any awards of its own. Then in 1960, the Bureau Personnel Committee,<sup>74</sup> through its chairman Irl C. Schoonover, wrote to Astin recommending the establishment of the Samuel Wesley

<sup>74</sup> The Bureau Personnel Committee met periodically to consider grade increases for personnel and to go over any personnel problems. Each of the divisions also had a personnel committee whose recommendations went to the Bureau committee.



Stratton Award to recognize "truly outstanding scientific accomplishment. Recipients selected to receive this honor should be presented with a bronze plaque and an honorarium at an appropriate ceremony." The committee made provisions for two awards each year, but also for omitting years in which no truly outstanding accomplishment was available.<sup>75</sup>

After some discussion with the department, the establishment of such awards was authorized on November 7, 1960, and on September 4, 1962, Astin wrote to the department with the committee's choice of recipients for the first two Stratton Awards. They were James R. Wait, the senior theoretician of the CRPL, "in recognition of his contributions to a better understanding of the mechanisms of electromagnetic radiation and radio-wave propagation" and, in a joint award, Peter L. Bender and Raymond L. Driscoll "in recognition of their contributions to precision electromagnetic measurement and particularly the determination of the gyromagnetic ratio of the proton." Each



James R. Wait came to NBS, Boulder from Ottawa, Canada, in 1955 to examine theoretical aspects of radio-wave propagation. He received a Department of Commerce Gold Medal for Exceptional Service in 1959 and one of the first Stratton Awards in 1962. In the following year, Wait was honored with an appointment as a Senior Research Fellow at NBS and was granted an Arthur S. Fleming Award by the Washington Junior Chamber of Commerce, recognizing him as "one of the ten outstanding young men in the Federal service, 1963." These early awards and honors would be augmented by many more over the course of Wait's distinguished career.

<sup>75</sup> Memorandum, I. C. Schoonover to A. V. Astin, "Stratton Awards." (NARA; RG 167; Astin file; Box 18; Folder Stratton Awards 1961-62). Date on memo is not legible.



Peter L. Bender, a joint recipient of one of the first Stratton Awards in 1962, was recognized for contributions to precision electromagnetic measurement and particularly the determination of the gyromagnetic ratio of the proton.<sup>76</sup> Bender was among the first group of seven Postdoctoral Research Associates that arrived at the Bureau in 1955-1956. He became a regular staff member in 1957 and, just two years later, received a Gold Medal for Exceptional Service from the Department of Commerce for his application of the principle of optical pumping to measurements of atomic constants and to the development of a rubidium clock.

recipient received a plaque and a \$1500 honorarium.<sup>76</sup> The establishment of the award and the work of the recipients illustrate well the emphasis management was placing on fundamental research.

These were not the last awards to be established. Since the Stratton Award was for basic science, other areas of the Bureau's work were in danger of being neglected. In 1964 the Edward Bennett Rosa Award was instituted for "outstanding achievements in the development of meaningful and significant standards of practice in the measurement field." This award recognizes another major aspect of the Bureau's activities and consists of an honorarium and a brass plaque.

Other awards followed: in 1966 the Bronze Medal for "work that has resulted in more effective and efficient management systems as well as the demonstration of

<sup>76</sup> Memorandum, A. V. Astin to C. Hayward, "Stratton Awards," September 4, 1962. (NARA; RG 167; Astin file; Box 18; Folder Stratton Awards 1961-62)

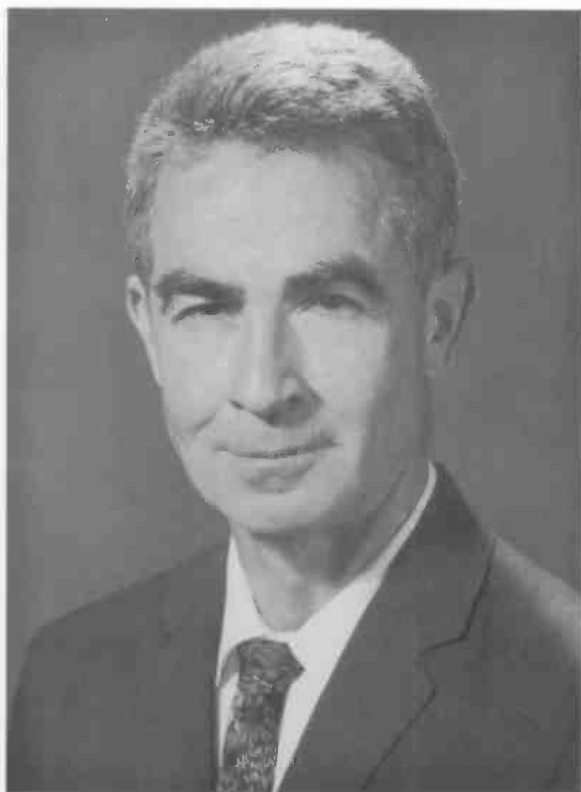

Raymond L. Driscoll came to NBS in 1936 and proceeded to accrue honors for his work in the area of experimental absolute electrical measurements and for the application of such measurements to the determination of atomic constants. In 1950 Driscoll won a Silver Medal for Meritorious Service from the Department of Commerce, and in 1959 he was awarded a Gold Medal for Exceptional Service. In 1962, the year the Stratton Award was inaugurated, Driscoll was a joint recipient for "contributions to precision electromagnetic measurement and particularly the determination of the gyromagnetic ratio of the proton."

unusual initiative or creative ability in the development and improvement of methods and procedures" (bronze medal, lapel emblem, certificate); in 1967 the Eugene Casson Crittenden Award for employees "who perform supporting services that have a significant impact on technical programs beyond their own offices" (honorarium and certificate); in 1974 the Edward Uhler Condon Award recognized "distinguished achievement in written exposition in science and technology" (aluminum plaque and honorarium); in 1975 the Applied Research Award recognized the "practical application of the results of scientific or engineering research" (mixed metal plaque and honorarium); in 1977 the Equal Employment Opportunity Award recognized "significant contributions to EEO which have been performed in an exceedingly outstanding manner" (anodized brass plaque and honorarium); in 1979 the NBS Safety Award, recognized "unusually significant contributions to the NBS Occupational Safety and Health program" (honorarium and certificate for individual recipients, certificate and plaque for group awards); in 1984 the Allen V. Astin Measurement Science Award recognized "outstanding achievement in the advancement of measurement science or in the delivery of measurement services" (bronze plaque and honorarium); in 1992 the William P. Slichter Award recognized "outstanding achievements by NIST staff in building or strengthening ties between NIST and industry" (certificate and honorarium); and in 1996 the George A. Uriano Award recognized "outstanding achievements by NIST

staff in building or strengthening NIST extramural programs, with emphasis on fostering U.S. competitiveness and business excellence" (certificate and honorarium). Presented at a special annual ceremony, the awards provide some happy occasions and result in stimulation for members of the staff.

In another arena, the civil rights struggles of the time shaped Government personnel action. In the Federal Government, equal opportunity had long been a policy.<sup>77</sup> Beginning in 1940 with Executive Order 8587, which was the first public statement of the principle that persons must not be discriminated against on the basis of race, color, or creed, and with the Ramspeck Act,<sup>78</sup> a series of other executive orders and legislation effectively barred such discrimination in the Federal Service. In 1955, with President Eisenhower's Executive Order 10590, which stated that equal opportunity was to be afforded to all qualified persons, a new active phase of EEO began, heightened by President Kennedy's introduction of affirmative action in 1961. Then the Congress produced legislation that went beyond the confines of Federal Government employment when the Equal Pay Act of 1963 prohibited "discrimination on account of sex in the payment of wages by employers engaged in commerce or in the production of goods for commerce."<sup>79</sup> In that same year, just before the landmark Civil Rights Act of 1964, the Department of Commerce began an EEO program. As a result, the Bureau sent a monthly memorandum to Assistant Secretary Hollomon listing the actions it had taken to improve EEO. A typical example lists six African Americans interviewed, two appointed, eight promoted, and one who received a cash award. The highest grade involved was GS-8, and most of those cited were at the GS-2 or GS-3 level. In addition, high-level management met with six black employees on housing problems in connection with the Gaithersburg move and other aspects of the Bureau's EEO activities of concern to minority employees.<sup>80</sup> The Bureau itself did not form an EEO Committee until May 1968. Hollomon was critical of the Bureau's EEO program, stating that it was concerned with only long-range problems and was not specific enough about goals on dates and numbers.<sup>81</sup>

\* \* \*

Outside the Office of the Director a number of changes were made before 1960, the most notable of them being the formation of the Radio Communications and Systems Division in 1959, with Richard C. Kirby as chief, in the Central Radio Propagation Laboratory. But the most significant changes occurred in mid-1960, and they were extensive indeed. After the retirement in 1959 of its long-term chief Francis B. Silsbee, the Electricity and Electronics Division was split into its component parts, reversing a merger made in 1953. The Electricity Division was formed under Chester H. Page,

<sup>77</sup> Equal Employment Opportunity Commission, Office of Equal Employment Opportunities, "Generational EEO Developments," [1991].

<sup>78</sup> *An Act Extending the classified executive civil service, U.S. Statutes at Large*, 54 (1940): 1211-1216.

<sup>79</sup> *Equal Pay Act of 1963, U.S. Statutes at Large*, 77 (1963): 56-57.

<sup>80</sup> Memorandum, A. V. Astin to J. H. Hollomon, "Progress Report on the NBS Equal Opportunity Program," December 17, 1963. (NIST RHA; Director's Office file; Box 381; Folder Chrono 7/63—12/63)

<sup>81</sup> Memorandum, J. H. Hollomon to A. V. Astin, "Equal Employment," June 19, 1963. (DOC; Assistant Secretary for Science and Technology; Accession 40-70A-6988; Box 11; Folder June 1963)

and the electronics component was merged with the Office of Basic Instrumentation from the Office of the Director, and the Mechanical Instruments Section from the Mechanics Division to form a new Instrumentation Division under G. Franklin Montgomery.

Following the retirement of its chief, Irvine C. Gardner, in 1959, Optics and Metrology became simply Metrology under Alvin G. McNish, picking up the Mass and Scale Section under H. Steffen Peiser and the old Capacity, Density, and Fluid Meters Section under Charles T. Collett from the Mechanics Division in the process.

Very important changes occurred in the Heat Division under Charles M. Herzfeld. The Engine Fuels Section, the last holdover from the automotive laboratory, was abolished. The Rheology Section under Robert S. Marvin was moved to the more appropriate Mechanics Division, and the Free Radicals Research Section under Arnold M. Bass, its work completed, was also abolished. However, two new sections were formed, and they were to become stellar performers. These were the Equation of State Section under Joseph Hilsenrath, and the Statistical Physics Section under Melville S. Green, which brought statistical mechanics research to the Bureau in a big way.

Condon's division, Atomic and Radiation Physics, had grown greatly and was replete with capable, enthusiastic, and ambitious young scientists. It was simply split into its two components: Radiation Physics under its vigorous long term chief, Lauriston S. Taylor, and Atomic Physics under the natural leader Lewis M. Branscomb. It was a pleasant separation for all concerned.

In a split that was not accepted with complete enthusiasm, the Chemistry Division was divided into Analytical and Inorganic Chemistry, under the temporary tutelage of Irl C. Schoonover, and Physical Chemistry, under the capable stewardship of relative newcomer Merrill B. Wallenstein. In the process, the Organic Coatings Section was abolished, and the Electrodeposition Section was moved to the Metallurgy Division, both moves consistent with the recommendations of the first Kelly Committee Report. Physical chemistry, with new sections on Molecular Spectroscopy under David E. Mann, Molecular Kinetics under Robert E. Ferguson, and Mass Spectrometry under Vernon H. Dibeler, was to become one of the stellar scientific divisions of the new Bureau.

The Mechanics Division was also extensively reorganized, but remained under the leadership of Bruce L. Wilson. Its Mechanical Instruments Section was transferred to the new Instrumentation Division; two sections were transferred to Metrology as described above; and two sections—Rheology under Robert S. Marvin from the Heat Division and a new section, Pressure and Vacuum under Daniel P. Johnson—were added.

In 1960, Boulder's Radio Propagation Physics Division under Ralph J. Slutz was split into Ionosphere Research and Propagation Division under Ernest K. Smith, Jr., and the Upper Atmosphere and Space Physics Division under C. Gordon Little. No new sections were formed, nor any old ones abolished. In 1962, the Radio Standards Laboratory also split into two divisions: the Radio Standards Physics Division under L. Yardley Beers and the Radio Standards Engineering Division under George E. Schafer. By 1963, Boulder had seven technical divisions, four in the Central Radio Propagation Laboratory, two in the Radio Standards Laboratory, and one in the Cryogenic Engineering Laboratory.

The Annual Report for 1961 described these changes as having been made "as part of the Bureau's efforts to meet the expanding needs of modern science and technology," but the changes were not yet complete.<sup>82</sup> In particular, the reorganization of the three materials divisions had not yet been accomplished. For two of these divisions, the changes were made less by movement of division parts than by installing new leadership at the division level. Thus, in late 1959, Alan D. Franklin was installed as chief of the Mineral Products Division, and in 1960 Lawrence M. Kushner, who had been chief of the Metal Physics Section, was appointed chief of the Metallurgy Division. Both were younger men who reorganized and re-oriented their divisions as time passed. For the Organic and Fibrous Materials Division, the changes were more substantial. In early 1962 it was renamed the Polymers Division in recognition of the fact that the industrially important organic materials were in fact synthetic polymers. The division remained under Gordon M. Kline, its long-time head, but five of its eight sections were abolished and replaced with a new set of four under new leadership. Robert B. Hobbs, however, remained in a leadership role, becoming chief of the Applied Polymers Standards and Research Section upon the abolition of the Paper Section which he had headed.<sup>83</sup>

These major changes did not occur without some rancor on the part of the staff. Older staff members who were passed over by younger or more capable persons were understandably upset, and those who were replaced—sometimes summarily—were naturally hurt. Many left the Bureau. The management, however, was serious in its desire to transform the Bureau and proceeded with its plans. The younger staff who had taken over positions of leadership were happy with the turn of events and brought a heightened vigor to their jobs. In a few short years the composition of middle management at the Bureau had been substantially recast.

Not planned and not part of this reorganization effort, a major change in leadership occurred in 1962 with the resignation of Frederick W. Brown, director of the Boulder Laboratories since their establishment in 1954. This resignation was not occasioned by the desire of management to re-orient the work at Boulder. Consisting of the Cryogenic Engineering Division, the Central Radio Propagation Laboratory, and the Radio Standards Laboratory, the work in Boulder was basic and scientifically modern. Rather, Brown's resignation was caused primarily by the nature of his position, although personality differences between him and Astin played a part. While he bore the title of director, he was not in charge of the technical work. The division chiefs in Boulder reported directly to the Bureau director, not the Boulder director. As a result, the Boulder director was not a great deal more than a caretaker, looking after administrative matters, taking care of the physical plant, and acting as the interface with the

---

<sup>82</sup> Annual Report, 1961: 17.

<sup>83</sup> The sections abolished were Rubber under Lawrence A. Wood, Textiles under Herbert F. Schieffer, Paper under Robert B. Hobbs, Leather under Joseph R. Kanagy, and Plastics under Frank W. Reinhart. The new sections were Macromolecules: Synthesis and Structure under Donald McIntyre, Polymer Chemistry under Leo A. Wall, Polymer Physics under Elio Passaglia, and Applied Polymers Standards and Research under Robert B. Hobbs. Dental Research under William T. Sweeney, Polymer Characterization under Norman P. Bekkedahl, and Polymer Evaluation and Testing under Robert D. Stiehler were not changed.



Frederick W. Brown was the first director of the Bureau's Boulder Laboratories from 1954 until 1962. Before coming to NBS, Brown served as technical director of the U.S. Naval Ordnance Test Station at China Lake, California. He was widely recognized as an outstanding administrator of scientific research and development programs as well as a technical expert. While employed by the Bureau of Mines during World War II, Brown authored what was long considered a classic in the field of theoretical calculations for explosives.

outside community. The direction of the technical work was determined by the division chiefs and the Bureau director with the associate director involved. The Boulder director doubtless had input in this process, but he was not a formal part of the technical line organization. Even in administrative matters, the amount of leeway the Boulder director had in interpreting Bureau administrative policies, and in making his own, was a source of some difficulty.<sup>84</sup>

But the Boulder problems were deeper and more endemic than merely the relationship between Brown and Astin. The Boulder staff chafed under what they thought to be restrictions on their freedom to select projects. Indeed, in 1958, an audit by the General Accounting Office found that the Boulder staff were eager to complain that Washington did not understand Boulder's problems and thus were not sympathetic to

<sup>84</sup> Memorandum, A. V. Astin to F. W. Brown, "Review and Definition of Washington-Boulder Relationships." (NARA; RG 167; Astin file; Box 20; Folder 1956). This memorandum is undated, and it is not known if it was ever sent. This same box contains a great deal more material on Boulder-Washington relationships.

Boulder's needs. Because their work mostly came under the "special missions" category, they felt that Washington was not as supportive of them as it should have been. The situation festered to the point that in early 1962 all the Boulder division chiefs, with Brown's knowledge, wrote memoranda to Astin expressing their views on the Boulder-Washington relationships. While some of the memoranda were quite moderate, others were more forceful. One division chief entitled his memorandum "My Reasons for Believing that CRPL Should Now Explore the Possibility of Finding a New Home Outside of the NBS."<sup>85</sup> Russell Scott, chief of the Cryogenic Engineering Laboratory, who would succeed Brown, wrote, "The activities of CEL are relegated by NBS policy to the status of 'secondary missions.' . . . [This] has hurt morale."<sup>86</sup> A third division



Russell B. Scott played a leading role in the development of the science of cryogenics. He joined the staff of the Bureau's Low Temperature Section in 1928 and became its chief in 1948. Following the establishment of the Cryogenic Engineering Laboratory in Boulder, Scott was transferred there as its chief. In 1963, Scott succeeded Brown as Boulder's director.

<sup>85</sup> Memorandum, chief, Radio Propagation Engineering Division to A. V. Astin, "My Reasons for Believing," February 6, 1962. (NARA; RG167; Astin file; Box 20; Folder Correspondence 1962)

<sup>86</sup> Memorandum, chief, Cryogenic Engineering Laboratory to A. V. Astin, "NBS Boulder-Washington Relations," February 6, 1962. (NARA; RG167; Astin file; Box 20; Folder Correspondence 1962)



chief did not feel that morale had deteriorated below the division chief level, but he made the point, "I suspect CRPL is considered more of a nuisance than a jewel by Washington management," and then continued, "I can also see how we would tend to grow more apart with Boulder increasingly reflecting the views of local management due simply to the separation in distance."<sup>87</sup> Yet another division chief recommended "complete delegation of authority to Boulder Laboratories' management for all policy formation, program planning, manpower, and fiscal controls, etc., pertaining to Boulder Laboratories."<sup>88</sup> He did not, however, say what was left for Washington to do. That was the rub of the matter. The installation 1700 miles from headquarters naturally began to feel more and more independent. However, complete independence was not possible without destroying the reason for existence of headquarters, save perhaps for the defense of the budget. Power necessarily had to be shared, but the final authority had to reside at headquarters. This placed the director of the Boulder Laboratories in a difficult position, with authority over some things but not over others. It appears that for Brown, who was very anxious to create the best research climate possible, his authority did not extend far enough, and so he resigned.<sup>89</sup>

Brown was replaced by Russell Scott, chief of the Cryogenic Engineering Laboratory. Significantly, his title was changed to manager of the Boulder Laboratories; there was now only one director, and he was in Washington. Under Scott unrest lessened. Then in 1965 the CRPL was transferred to the newly formed Environmental Science Services Administration (ESSA) and all questions of "secondary missions" ceased. The CRPL laboratories remained in the same location despite the fact that they were no longer part of the Bureau, and it is significant that the name of the site remained "Boulder Laboratories." Scott now managed Boulder for both ESSA and the Bureau.

### **JILA, The Joint Institute for Laboratory Astrophysics**

The Bureau's annual reports for 1959-1961 feature discussions of a new program in plasma physics and astrophysics that the Bureau intended to emphasize. With the development of space science brought about by rocket and satellite capabilities and of research in thermonuclear power, interest in the behavior of very hot gases and plasmas had grown substantially. But the relevant fields of physics were poorly understood and, as a result, progress was being held up in the fields of space exploration and astrophysics, thermonuclear power and plasma physics, rocket re-entry problems,

---

<sup>87</sup> Memorandum, E. K. Smith to A. V. Astin and R. D. Huntoon, "Boulder/Washington Relations," February 2, 1962. (NARA; RG167; Astin file; Box 20; Folder Correspondence 1962)

<sup>88</sup> Memorandum, chief, Division 87 to A. V. Astin, "Recommendations Regarding the Management of Boulder Laboratories," February 6, 1962. (NARA; RG 167; Astin file; Box 20; Folder Correspondence 1962)

<sup>89</sup> Brown went to the U.S. Embassy in Buenos Aires, and his departure was without rancor. A few years later Astin was to help Brown in his attempt to find a new position. Letter, A. V. Astin to F. W. Brown, August 20, 1964 (NIST RHA; Director's Office file; Box 381; Folder 5/64-8/64); Letter, A. V. Astin to F. W. Brown, April 28, 1965 (NIST RHA; RG 167; Director's Office file; Box 381; Folder 1/1/65-4/30/65)

ultra-high temperature research, and atmospheric research. Lacking were "precise measurement techniques, standards, and basic data on the fundamental properties of the hot gas or plasma."<sup>90</sup> The Bureau's new program was to emphasize these areas, and the implementation of the program would eventually lead not only to a decentralized but coordinated Laboratories for Astrophysical and Plasma Research involving some 100 senior staff members, but also to the formation of a wholly new and novel organization called the Joint Institute for Laboratory Astrophysics (JILA).<sup>91</sup>

The Bureau was not starting from scratch in this field. Along with work in the measurement of very high temperatures and with astrophysical and ionospheric studies in Boulder, it had a small program in laboratory astrophysics, loosely defined as the laboratory study of the atomic properties and processes of importance to astrophysical phenomena. The program was centered in the Atomic Physics Section under Lewis M. Branscomb, who had been chosen in 1959 to coordinate the development of a larger program.<sup>92</sup> In 1960, a presentation of the Bureau's present program and plans for its future program was made to the Space Science Board of the National Academy of Sciences, whereupon that body sent a resolution to the secretary of commerce:

The Board foresees that a strong limitation to progress in physical interpretation of experiments and observations of the terrestrial, planetary, solar and stellar atmospheres is the lack of sufficient understanding of basic physics of atoms and molecules in the environment which they encounter in these atmospheres. The Board feels that basic work on atomic cross sections, reaction rates and interaction with radiation fields both individually and cooperatively should be encouraged wherever interest exists or may be stimulated.

The Board is aware of the excellent work in various such aspects of laboratory and theoretical astrophysics done by groups at the National Bureau of Standards, and, as a supplement to the above, believes that the Government should recognize in a formal way this potential in a federal laboratory for a coordinated and relatively comprehensive approach to these problems which are so important to space science.<sup>93</sup>

---

<sup>90</sup> Annual Report, 1961: 6.

<sup>91</sup> Memorandum, A. V. Astin to R. E. Giles, "The NBS Program in Laboratory Astrophysics, Appendix I," February 28, 1962. (DOC; Assistant Secretary for Science and Technology; Accession 40-68B-6087; Box 28; Folder National Bureau of Standards). The defining document for JILA is "Memorandum of Understanding between the National Bureau of Standards and the University of Colorado concerning the collaborative establishment of a Joint Institute for Laboratory Astrophysics." (History Project File; Chapter 4; Folder JILA). The document will be referred to as MOU.

<sup>92</sup> In 1960 Branscomb became chief of the new Atomic Physics Division and Stephen J. Smith became chief of the Atomic Physics Section. A description of the program Branscomb coordinated is given in *Measurements and Standards in Plasma-Physics and Astrophysics at the National Bureau of Standards*, Lewis M. Branscomb, ed., Natl. Bur. Stand. (U.S.) Technical Note 59; (July 1960).

<sup>93</sup> Annual Report, 1960: 10-11.

Similar opinions were expressed in 1962 by the FCST, which had appointed a panel to study the problem in 1960: the Bureau's "statutory responsibility for precise measurements . . . [make] the NBS a focal point for laboratory astrophysics. Directly appropriated funds for operations and facilities should be made available to NBS to complete the establishment of a long range interdisciplinary laboratory and theoretical astrophysics program."<sup>94</sup>

Earlier, Branscomb had developed unique plans for an effort in laboratory astrophysics that did not involve the Bureau. The recipient of a Rockefeller Public Service Award, he had spent the 1957-1958 academic year at University College, London, gathering material for a book on negative ions which he never wrote. He was not unaware of the connection between atomic physics and astrophysical problems. Through his colleagues William Meggers and Charlotte Moore Sitterly, Branscomb had contact with the International Astronomical Union (IAU). His association with Professor Michael Seaton of University College strengthened that contact. Moreover, the study of material for his proposed book sharpened his interest in astrophysics, turning his attention to the role of negative ions in stars. Thus, with his way eased, Branscomb obtained an invitation to the General Assembly of the IAU in Moscow. There he met Richard N. Thomas, one of two astrophysicists from the Boulder Laboratories. With the other Boulder astrophysicist, John T. Jeffries, Thomas was administratively housed in the Office of the Director of the Boulder Laboratories. Branscomb had known Thomas slightly at Harvard, and in their discussions in Moscow, they conceived the idea of a "proper group of atomic physicists interested in astrophysical applications, and astrophysicists who wanted to do the astrophysics, not in the classical way, but in the modern quantum mechanical way. . . . We cooked up the idea, the two of us, that if somehow we could take the atomic physics group in Washington and these two astronomers [Thomas and Jeffries, a guest worker from Australia] in Boulder, and marry them up, we would leave the Bureau and we would go somewhere, and we would do this great thing." The main impetus behind this idea was that Branscomb was not satisfied with simply measuring and publishing properties of matter. He wanted to see his work applied. The marriage of atomic physicists and astrophysicists would help assure that the work of the atomic physicists would be used by astrophysicists, and doing the work in the free environment of a university would also attract workers in other fields such as aerodynamics. Thus, notwithstanding its fundamental nature, the work of the atomic physicists would be "applied research."<sup>95</sup>

When Branscomb returned from his sabbatical, he told Astin of the ideas that he and Thomas had and gave notice that he would like to try to "find someplace to go and try to do all this stuff." Astin pointed out to Branscomb that he need not leave the Bureau to do this and reminded him that the Bureau had at one time set up the Institute for

---

<sup>94</sup> Memorandum, A. V. Astin to E. Gudeman, "The NBS Program in Laboratory Astrophysics," February 14, 1962. (DOC; Assistant Secretary for Science and Technology; Accession 40-68B-6087; Box 28; Folder National Bureau of Standards)

<sup>95</sup> Interview with L. M. Branscomb, July 11, 1988: 70. (NIST Oral History File); Letter, L. M. Branscomb to E. Passaglia, August 23, 1991. (History Project File; Chapter 4; Folder JILA)

Numerical Analysis as a joint effort between the Bureau and UCLA. Why not do the same thing in this field? Thus was the idea of a Joint Institute for Laboratory Astrophysics born.<sup>96</sup>

While coordinating the work of the Atomic Physics Division, Branscomb's ideas for the joint institute were sharpened. The institute would consist of astrophysicists and atomic physicists already on the Bureau staff and faculty members, fellows, and students from appropriate departments of a university. The senior members of the NBS component would be professors adjoint in the university. Visiting scholars, important in the institute, were expected to number about ten per year.

The disciplinary core of the institute was to be atomic and molecular physics, radiative transfer theory, and eventually quantum electronics, while the applications were to be in atmospheric chemistry, missile wake dynamics, plasma physics, and astrophysics. Particularly important was the emphasis that Thomas placed on the solution of the nonequilibrium, nonlinear radiative transfer problem. All of this required knowledge of atomic collision cross-sections and nonequilibrium radiative transfer theory.<sup>97</sup>

Thus, the institute would carry out research in astrophysics and low energy atomic physics, do theoretical analysis of astronomical observations, and study the physics of the astronomical medium. In short, it was to be a collaboration of atomic physicists and astronomers/astrophysicists. From the point of view of the NBS participants, the university environment promised greater academic freedom, the availability of graduate students, interaction with visiting scholars, and the opportunity to see their results applied. From the point of view of the university, the Bureau could provide sound, experienced administrative personnel, superb shop facilities, and teaching, for an important function of the institution was the training of students in these fields.<sup>98</sup> The university could get grants from agencies such as the NSF where the Bureau could not. In addition, for the university it would be an interdepartmental-interdisciplinary research facility with new opportunities for students and faculty.

The final Bureau plan for its effort in plasma and astrophysics was that the Bureau would form the Laboratories for Astrophysical and Plasma Research, with work to be performed by appropriate members of various divisions in Washington and Boulder.<sup>99</sup> Then, following the lines set out by Branscomb, there would be formed with a yet-to-be-chosen university an organization first called the Joint Institute for Astrophysics and Atomic Physics and finally called the Joint Institute for Laboratory Astrophysics.<sup>100</sup> It was this latter part of the program that made it unique.

<sup>96</sup> Interview with L. M. Branscomb, July 11, 1988: 71. (NIST Oral History File)

<sup>97</sup> Personal communication, L. M. Branscomb to E. Passaglia, August 23, 1991.

<sup>98</sup> Much of this material is from "Joint Institute for Astrophysics and Atomic Physics," December 19, 1961, an early planning document written by Branscomb. (History Project File; Chapter 4; Folder JILA)

<sup>99</sup> A formal program of this kind appears not to have been instituted, although the planned work was carried out.

<sup>100</sup> Interview with L. M. Branscomb, July 12, 1988: 10-28. (NIST Oral History file); proposal, L. M. Branscomb, December 19, 1961, "Joint Institute for Astrophysics and Atomic Physics"; memorandum, A. V. Astin to E. Gudeman, "The NBS Program in Laboratory Astrophysics," February 14, 1962. (DOC; Assistant Secretary for Science and Technology; Accession 40-68B-6087; Box 28; Folder National Bureau of Standards)

Even before the idea had been completely approved, the Bureau began to implement the formation of the joint institute. The problem was to find a suitable university, define the relationship between the two parties, determine the organizational position of the institute in the NBS hierarchy (Branscomb was insistent that it have division status), and tend to the myriad administrative and financial details that the formation of such an organization entailed.<sup>101</sup> Approaches were first made to Harvard and to the University of California at San Diego. Both universities were anxious to have the organization, but both universities wanted their faculty to decide which Bureau people would be given faculty positions. The Bureau people would not accept this, and negotiations were effectively killed.

The next school approached was the University of Arizona. With the Kitt Peak National Observatory established there and observational astronomy sure to be strong and growing, this seemed to be an excellent partner. The only problem was that the physics department at the University was weak, awarding degrees only up to the masters. The NBS group felt that in this situation they would be only a service group to the astronomers. Prizing their independence and autonomy, Arizona was rejected.

The last university investigated was the University of Colorado in Boulder, which, with its High Altitude Observatory and its Laboratory for Atmospheric and Space Physics, had capabilities complementary to those of the NBS group. The presence in Boulder of the National Center for Atmospheric Research was an added bonus. Here a happy marriage was made, though not because the Bureau already had an establishment in Boulder. In Branscomb's words, "[that was] a negative factor. We would have been happier to go to Boulder without it, because we really wanted not to be in the Bureau's administrative environment. We wanted to be in an academic one."<sup>102</sup> With the leadership of University President Quigg Newton, who was very receptive to the union of the two institutions, with the advantage of Thomas and Jeffries already being in the area, and with complementary capabilities on the two sides, a Memorandum of Understanding (MOU) was drawn up and submitted to the two parties. On the Bureau side, approval had to be obtained from the department, and Astin had largely cleared it with Under Secretary Gudeman.

What made the proposed organization unusual and easier to sell was its unique concept. Neither the Bureau nor the university would lose any autonomy by forming the institute. All the workers in the institute (including administrative and supporting personnel) would remain the employees of one or the other institution. Since it was planned that the institute would be located in a new building on the university campus, the space required would be owned by the university and the Bureau would simply

---

<sup>101</sup> Branscomb Oral History, July 12, 1988: 10-28.

<sup>102</sup> *Ibid.*, 12-13.

pay a fee for its use.<sup>103</sup> While not specifically mentioned in the MOU, title to equipment would also reside in one or the other institution. Under this arrangement the proposed institute owned no property and had no employees, hence in this sense did not legally exist. The Bureau would simply carry out one of its programs in an admittedly unusual place, a place for which it made a payment, but spent no money inappropriately. It retained complete control of its program. The Bureau did have the responsibility for providing funds for the visiting scientists. These funds were provided as a grant to the university, which then dispersed them to the visiting scholars.

The fact that some Bureau staff would do some teaching did require justification. The Bureau argued that the teaching would consume only a very small fraction of a scientist's time, that it would be done only at the postgraduate level, and that it was, moreover, an integral part of doing research.<sup>104</sup> The idea was accepted and the road to the formation of JILA was cleared.

On the university side, the memorandum had to be cleared by the Board of Regents. After a Saturday presentation to them by Branscomb, the clearance was obtained and JILA was formed. On April 18, 1962, the MOU was signed by Astin and on April 25 by President Newton. Even before these signings, with approval by the Board of Regents, a public announcement of the joint venture was made on April 13, 1962. It was accepted enthusiastically by the Boulder community.

It was not a large organization when formed. There were nine members from Washington, Thomas and Jeffries from Boulder, and three appointed by the university. But by 1967, the permanent scientific staff numbered twenty-four, with forty graduate students and twenty visiting scientists.<sup>105</sup>

The management of the institute was novel for a hierarchical organization like the Bureau, but rather more common in the collegial environment of universities. The MOU called for two types of appointments: fellows and members. Fellows were defined as Bureau staff members who were professors adjoint or who held equivalent civil service grades, and university associate professors and professors. Visiting scholars

---

<sup>103</sup> The rent situation was not simple. Briefly, the National Science Foundation was willing to fund half the cost of the JILA building if the University had the funds for the other half. The University did not have these funds, but it arranged to borrow them from the State Escrow Fund, essentially the retirement fund. As security it used a letter from Branscomb "pointing out that the Bureau of Standards was going to occupy half of this building and was going to pay a payment in lieu of rent of an agreed amount which the Bureau auditors had agreed to as a reasonable compensation for the space we would use, and that this revenue would be more than sufficient to amortize this university loan in a reasonable period of time. In effect . . . [the Bureau] matched . . . [NSF's] money . . . but the Bureau of Standard's money was paid out over a period of time." Moreover, since the Bureau and university people were completely intermixed, there was no way to determine what space was assigned to which group. Thus the Bureau did not pay rent; it paid a fee in lieu of rent. Branscomb Oral History, July 12, 1988: 26-28.

<sup>104</sup> Memorandum, A. V. Astin to R. E. Giles, "Proposed agreement between the NBS and the University of Colorado," April 9, 1962. (DOC; Assistant Secretary for Science and Technology; Accession 40-68B-6087; Box 28; Folder National Bureau of Standards)

<sup>105</sup> R. H. Garstang, "The Joint Institute for Laboratory Astrophysics," *Sky and Telescope*, 23(3) (March 1967): 2-4.

were all members. The MOU specified that the university contingent would come from the Department of Physics or be "appropriate members of the University faculty in high temperature aerodynamics and fluid physics." The Fellows of JILA formed a small council, which in theory was advisory only, but in practice was able to make decisions that could be carried out by either the chief of the Laboratory Astrophysics Division on the Bureau side or the chairman of the Physics Department on the university side. The fellows elected a chairman from their members, the chairmanship rotating back and forth between the Bureau and university contingents. The system is still in effect.

The new building for JILA near the center of the campus was planned by the university as part of a physics and astrophysics complex, but construction was not completed until 1966. The Bureau people, however, came out to Boulder in the summer of 1962, setting themselves up in the same armory their predecessors had occupied almost ten years earlier when the cryogenics and radio propagation staffs first came to Boulder.

While most of the staff from Washington were atomic physicists and spectroscopists, Branscomb had longer range visions than merely laboratory astrophysics. With the urging of Peter L. Bender, one of the recipients of the first Stratton Awards, he also brought John L. Hall, whose field was the then relatively new one of lasers. Not only were lasers expected to be useful in the study of the nonlinear properties of atoms, Branscomb properly viewed the laser as a premier tool for fundamental metrology. Indeed, by 1976 the JILA program had evolved to the point where an addendum to the MOU was made. The program now included:

laser physics, precision measurements, geophysics, and data and measurements necessary for the understanding of reaction mechanisms in the atmosphere; to the collection and evaluation of the scientific data; and to the education of scientists.

In view of these contributions . . . the purpose and role of the Joint Institute for Laboratory Astrophysics shall continue to evolve and expand beyond the areas of science outlined in the original Memorandum of Understanding.<sup>106</sup>

As an almost humorous aside, JILA was formed less than a month before Hollomon assumed his position as assistant secretary for science and technology. It appears that he did not believe that the Bureau should be involved in such an effort. He sent Astin a copy of an article by Branscomb and Thomas that had appeared in *Physics Today* with notations questioning the scientific objectives as described by the authors.<sup>107</sup> In response, Astin wrote him a memorandum about JILA. In the margin of this memo Hollomon wrote, "Allen, honestly I guess I don't see how it connects with the

---

<sup>106</sup> "An Addendum to the Memorandum of Understanding Between the National Bureau of Standards and the University of Colorado Concerning the Collaborative Establishment of a Joint Institute for Laboratory Astrophysics, March 1976." (History Project File; Chapter 4; Folder JILA)

<sup>107</sup> L. M. Branscomb and R. N. Thomas, "Laboratory Astrophysics," *Physics Today* 15(11) (November 1962): 42-46.

Standards business—Isn't this just the sort of thing NSF is supposed to do—H,” and returned the memo to Astin.<sup>108</sup> Nothing came of this exchange; JILA was an eminently successful example of interaction between the Government and academia. Its MOU was used by several other Government agencies as a model of such collaboration. To this day it remains a thriving and successful institution. One, however, cannot help but wonder what would have happened had Hollomon arrived a year earlier.

### The National Standard Reference Data System

Well-known and accurate data are the lifeblood of science and engineering. Whether the problem is the design and execution of an experiment in science or the design of a nuclear reactor in engineering, accurate data are essential. These self-evident facts were formalized when, at the organizational meeting of the International Union of Pure and Applied Chemistry in 1919, the new organization approved the production of the *International Critical Tables of Numerical Data of Physics, Chemistry and Technology*. The task of organizing the compilation of these tables was given to the United States, whereupon the National Research Council took on executive, editorial, and financial responsibilities for the project. A large part of the funding came from industry. A board of trustees and board of editors were instituted with the help of the American Chemical Society and the American Physical Society, and in 1926 the first of seven volumes of critical—meaning well-evaluated—data was published.

The Bureau had a significant role in this effort. The then director, George K. Burgess, was a member of the board of editors and Edward W. Washburn, chief of the Bureau's Chemistry Division, was editor-in-chief. By 1933, the first seven volumes and the index to the first edition were finished but, with the onset of the Great Depression, the lack of funds caused work on the critical tables to lapse. Then in 1955, with stimulus by Astin, the Office of Critical Tables was founded in the National Academy of Sciences-National Research Council to encourage the formation of new groups and to develop standards of criticality. However, the office had no funds; its role was purely advisory and no directly sponsored program resulted.<sup>109</sup>

By the early sixties the mushrooming of science made action on standard reference data essential. Indeed, in 1962 Astin acted unilaterally to form a committee under Merrill B. Wallenstein, chief of the newly formed Physical Chemistry Division, charging it to lay out what a suitable Bureau role in standard reference data would be.<sup>110</sup> The Bureau was thoroughly familiar with reference data. Not only did it have the history of participation in the International Critical Tables Project, but NBS periodically published compendia of reference data from its own work and from data obtained from the literature. It had background in obtaining data, compiling and evaluating them.

<sup>108</sup> Memorandum, A. V. Astin to J. H. Hollomon, "The Joint Institute for Laboratory Astrophysics (JILA)," December 7, 1962. (NARA; RG167; Astin file; Box 17; Folder Correspondence re Senior Appointment)

<sup>109</sup> Interview with Edward L. Brady, August 10, 1987: 2. (NIST Oral History File)

<sup>110</sup> *Ibid.*, 2-3.



This Bureau study and those of others in the scientific community pointed to the need for a decentralized program managed by a small office at the Bureau, but having data centers throughout the country.<sup>111</sup> Learning of this plan through its Committee on Scientific Information, the Federal Council for Science and Technology issued a "Federal Policy on National Standard Reference Data System" on May 28, 1963.<sup>112</sup>

The policy read:

There will be established a National Standard Reference Data System (NSRDS) to provide on a national basis critically evaluated data in the physical sciences. The NSRDS will consist of a National Standard Reference Data Center (NSRDC) at the National Bureau of Standards and such other Standard Reference Data Centers as may be required.

The National Bureau of Standards will be charged with the administration of the National Standard Reference Data System. This assignment will include the establishment of standards of quality, methodology including machine processing formats, and such other functions as are required to ensure the compatibility of all units of NSRDS.

The policy went on to state that centers could be assigned to departments or agencies, in which case that organization would administer the center and bear the costs but would have to "meet the quality standards and other requirements of the NSRDS." Centers could also be established at universities and research institutes, but to be included in the NSRDS they would have to meet the standards and requirements of the system.<sup>113</sup> Nine days later the FCST policy was followed with a press release from the Office of Science and Technology announcing the policy and pointing out that the responsibility for data compilation held by NBS, the Department of Defense, the AEC, NASA, the NSF and several other agencies was concentrated at a single point. The Bureau had a new function.<sup>114</sup>

But the Bureau was prepared. As a result of the study begun by Astin, John D. Hoffman, then chief of the Dielectrics Section, contacted Edward L. Brady, a friend with whom he had worked at the General Electric Research Laboratory. Brady had considerable experience in international atomic energy circles and was now at the General Dynamics Corporation in San Diego. When asked about heading up the NSRDS, a position that clearly required great tact and diplomacy, Brady felt the "concept sounded very good to me, and I was excited at the opportunity. . . ."<sup>115</sup>

---

<sup>111</sup> Committee on Science and Astronautics, Subcommittee on Science, Research, and Development, *A Bill to Provide a Standard Reference Data System: Hearings Before the Subcommittee on Science, Research, and Development of the Committee on Science and Astronautics, U.S. House of Representatives, 89th Cong., 2d sess., on H.R. 15638, superseded by H.R. 16897, June 28, 29, and 30, 1966: 31. Testimony of A. V. Astin.*

<sup>112</sup> "Appendix A" in Edward L. Brady and Merrill B. Wallenstein, *National Standard Reference Data System Plan of Operation*, Natl. Bur. Stand. (U.S.) National Standard Reference Data Series 1; December 1964.

<sup>113</sup> *Ibid.*

<sup>114</sup> *Ibid.*, Appendix B.

<sup>115</sup> Brady Oral History: 2.

Upon joining the Bureau in 1963 Brady formed the Office of Standard Reference Data (OSRD) to manage the program, staffed the office, organized a review committee—later called an evaluation panel—and began the interaction with the national and international communities that were involved in the data collection, evaluation and dissemination efforts that were to always characterize the OSRD. Most important, Brady did everything in the open, writing with Wallenstein a document giving the plan of operation of the system and its philosophy.<sup>116</sup> In that document the scope of the NSRDS was laid out, along with a discussion of appropriate activities, the organization and management of the system, the budgetary plans, and a plea to the technical community for its cooperation.

The philosophy of operation of the system was perhaps best laid out in a discussion of the definition of standard reference data. The definition states that “Standard Reference Data means critically evaluated quantitative information relating to a property of a definable substance or system.”<sup>117</sup> Illustrative of Brady’s diplomatic experience, this is clarified:

To obtain complete precision of meaning, most of the terms used in the above definition would themselves require definition. However, the purposes of the National Standard Reference Data Program do not require such precision. General, flexible guidelines on the scope of the program and appropriateness of specific activities are quite sufficient. Decisions will be made taking into consideration all relevant circumstances.<sup>118</sup>

Importantly, priorities for choice of properties and substances were to be determined by the needs of the U.S. technical community.

Despite a chronic shortage of funds—somewhat alleviated by funds from various agencies and by cooperative programs with industry—the system flourished. When the office was formed there were five data centers in the Bureau: chemical thermodynamics, atomic transition probabilities, atomic cross sections, ceramic phase equilibria, and cryogenics.<sup>119</sup> In 1988, there were seventeen centers in the Bureau and seven outside.<sup>120</sup> Moreover, the OSRD funded many short-term projects carried out by scientists in outside institutions.

Despite the fact that the assignment was given to the Bureau by the White House, it did not have the legal force of an Executive Order. Ever conscious of his situation with CRPL and other special assignments, Astin wanted the task to have a firm legal

---

<sup>116</sup> Brady and Wallenstein, National Standard Reference Data System Plan of Operation.

<sup>117</sup> *Ibid.*, 4.

<sup>118</sup> *Ibid.*

<sup>119</sup> Annual Report, 1963: 8.

<sup>120</sup> Office of Standard Reference Data, *1988 Annual Report Submitted to the Panel for the Office of Standard Reference Data, Board on Assessment of NIST Programs, National Research Council, December 5-6, 1988* (Washington, D.C.: U.S. DOC, NIST, 1988): 37-41. (History Project File; Chapter 4; Folder Standard Reference Data). The OSRD was not involved in the administration or funding of three of the outside data centers but assisted in dissemination of their outputs.

basis.<sup>121</sup> He began an effort to obtain passage of a law that would do this. Astin was successful and, in July 1968, Congress passed the Standard Reference Data Act, which largely repeated the functions specified by FCST, but assigned them to the secretary of commerce.<sup>122</sup> The law also spelled out some of the procedures to be followed, such as publishing in the *Federal Register* "such standards, criteria, and procedures for the preparation and publication of standard reference data as may be necessary to carry out the provisions of this act." The law made provision for the sale of documents and, rather importantly, for their copyright. In an unusual step, the secretary of commerce was given the authority to "secure copyright . . . of any standard reference data which he prepares or makes available under this Act." This authority, which is almost unique in the Federal Government, stood the Bureau in good stead in arranging the means of publication of reference data.

It was clear from the outset of the NSRDS that the aim of the program was not the production of a new or continuing set of *International Critical Tables*. Science had become too big and diverse. Moreover, scientific data were not static, and more accurate values became available as measurement techniques improved. Data could not be codified once and for all in a set of numbers buried in books enshrined on library shelves. In addition, the concept of critical evaluation required that the sources of the data and their validity be discussed and documented—an OSRD innovation and not a feature of earlier compendia. Thus, the form of the evaluated data outputs was expected to vary with the subject, and to range from tables of numbers through critical reviews of the status of data in particular fields to complete monographs containing graphs and figures. In the beginning, most of this output was published in the NBS-NSRDS series, but some was published in appropriate scientific journals. Later, machine-readable data bases covering many types of data were made available. The OSRD and individual data centers also responded to individual inquiries for specific information.

Despite the diversity of means of output, or perhaps because of it, it became clear to David R. Lide, who in 1969 succeeded Brady as head of OSRD, that some identifiable archival method of publication of reference data was desirable. Under his leadership, the Bureau entered into an agreement with the American Chemical Society (ACS) and the American Institute of Physics (AIP) for the publication of a journal devoted to standard reference data. Named the *Journal of Physical and Chemical Reference Data* (JPCRD), publication began in 1972. Initially published quarterly, but later bimonthly, with offprints of individual papers available for separate purchase, the journal provided

---

<sup>121</sup> When asked about need the for the proposed legislation at the House Hearings on the Standard Reference Data Bill, Donald F. Hornig, then director of OST, replied, "I think the main answer I would give . . . is that when we talk about the provision of a general service for many agencies of the Government, it becomes very hard for the agency providing it to justify it in terms of its own particular missions. . . . [T]he most important thing that is involved here is the general expression of intent by Congress that this general service should be performed and not justified strictly in terms of the Department of Commerce's own needs in this case." The statement clearly reflects Astin's own feelings. (NSRDS Hearings: 16)

<sup>122</sup> *Standard Reference Data Act, U.S. Statutes at Large*, 82 (1968): 339-340.

a continuing and identifiable means for the publication of standard reference data. The involved institutions shared responsibilities: the Bureau for editing and content, the AIP for production, and the ACS for dissemination. Proceeds were shared among the three organizations. Using the authority given him by the Standard Reference Data Act, the secretary of commerce copyrighted the contents of the journal and then assigned the copyright jointly to the AIP and the ACS. The government, however, retained the right to unlimited copying for its own use of materials originating in its own laboratories. Today the JPCRD continues to be the leading source of evaluated reference data and publishes contributions from scientists throughout the world as well as from groups that are part of the NSRDS.

It was always recognized that some costs of the NSRDS operation would be recovered by the sale of documents, and this was the principal reason for granting the secretary the power of copyright in the law. The question was always how much could be recovered. All printing and publication costs could be recovered without charging excessive prices, but it was impractical to recoup the cost of the research that led to the production of the data. Only judgment could decide how much of the compilation and evaluation costs (i.e., the costs of the OSRD and the data centers) to try to recover. Brady estimated that only 5 percent to 10 percent of the total OSRD budget could be recovered in this manner. This, though, was not enough for Hollomon, who was a strong supporter of the program. Wanting to impress the Senate and promising to produce \$5 million in fees, the assistant secretary estimated 25 percent, which dismayed Brady. Determined by a trade-off between high prices with high cost recovery and low prices to increase availability, cost-recovery in fact averaged 5 percent to 6 percent.<sup>123</sup> In 1964, appropriations for the program were \$3.5 million but, over the years, they remained quite static.<sup>124</sup> Despite the fact that the inflation-adjusted appropriation steadily decreased, the SRD program was able to increase its output through cooperative projects with industry, other government agencies, and foreign data centers.

### **Civilian Industrial Technology—The Bureau Gets a Small, Short Program**

The first significant action J. Herbert Hollomon undertook when he became assistant secretary for science and technology in May 1962 was the development of a program called Civilian Industrial Technology (CIT). It was not that he was the originator of the idea for the program. In fact, prompted by a memorandum from Science Advisor Jerome Wiesner and economist John Kenneth Galbraith, President Kennedy formed a White House Panel on Civilian Technology in the summer of 1961. Composed of Wiesner, Secretary of Commerce Luther Hodges, and Chairman of the Council of Economic Advisors Walter Heller, the panel was "assigned the duty of encouraging the utilization of technology in the civilian economy."<sup>125</sup> The Department of Commerce was chosen as the standard bearer for spurring economic growth.

<sup>123</sup> Brady Oral History: 8-9.

<sup>124</sup> Appropriations Hearings for 1965: 600; Brady Oral History: 7.

<sup>125</sup> Katz, *Presidential Politics*: 139.

Thus, when Hollomon joined the department, at least one of his tasks was laid out for him. The new assistant secretary was not a stranger to the White House activity. On March 6, 1962, just two months before joining the department, Hollomon addressed a meeting of the White House Panel on Civilian Technology on the related work he had been carrying out with the Engineers' Joint Council's Engineering Research Committee.<sup>126</sup> Moreover, his own beliefs on the role of science and technology were nicely parallel to the aims of the panel. "Scientific and technological resources are a major basis for economic development and for national power, and we do not yet know how best to deploy them," Hollomon wrote in *Science*. He continued, "The relative roles of private and public participation in the use of science and technology for practical purposes are not clear, nor do we know how to employ fully the fruits of science for the improvement of our society."<sup>127</sup>

With this background, Hollomon "hit the ground running." By the fall of 1962 he had put together a program. However, contrary to the advice of the Bureau of the Budget that he seek legislative authority for his program, Hollomon went to Congress for a supplemental appropriation—normally used only for unexpected needs, not for the initiation of programs. He was using the appropriation route to obtain authority for the program, which in effect circumvented the legislative route. This tactic was to prove costly.<sup>128</sup>

Both Hollomon's program and the concepts of the White House Panel were meant to correct four problems. First, Government funding of science and technology had led to an unbalanced condition in which most of the money was going to the military and "space," and with the maturing of those fields there had been a significant drop in the spin-off of technology useful in the civilian sector. Second, this imbalance led to the hiring of the bulk of science graduates by the military and "space." Third, the technological pre-eminence of the Nation in international commercial markets was in danger of being eroded because other nations, unencumbered by military and "space" requirements, could devote an increasingly greater share of their resources to civilian technology. And fourth, the program hoped to correct the inertia or structural inability to develop technology of certain industries and firms.

Hollomon's program had two broad objectives. Technical advances were to be stimulated in the segments of the economy which most needed the benefits of technology, thereby enhancing economic growth and the ability to compete on the world market. Since the bulk of research and development funds were expended by large firms, the program was directed at those industries that were made up of small firms which could not support "even jointly, any significant research." The other objective was to "encourage the rapid diffusion of technology" which would "help close the gap

---

<sup>126</sup> Letter, M. Michaelis to A. V. Astin, February 19, 1962. (NARA; RG167; Astin file; Box 14; Folder untitled). Included is the program for the three-day meeting. Astin was asked to discuss "New Goals for the National Bureau of Standards: A National Institute of Applied Science and Technology."

<sup>127</sup> Letter to the editor, J. H. Hollomon, "Government and Science: How Science Policy is Developed." *Science* 143 (January 31, 1964): 429.

<sup>128</sup> Katz, *Presidential Politics*: 140.

between the technically leading and lagging industries and firms."<sup>129</sup> Widely perceived to be a program that would help the laggards at the expense of the leaders, CIT's objectives caused consternation in some sectors, particularly the building industries. To achieve these objectives, Hollomon proposed a program with seven elements:<sup>130</sup>

1. Support of university activities for the creation of more scientists.
2. Support of research institutes serving industry.
3. Dissemination of technical information in a useful form for specific industries.
4. Support of research and development projects for needy industries at universities and research institutes.
5. Application of systems-research to whole industries.
6. Research conferences in chosen industrial fields.
7. Support of journals and other means of dissemination of information where necessary.

The industries chosen for specific support were textiles and apparel, building technology, and machine tools. Another group of industries was not supported at that time because not enough data were available to decide on the specific requirements for them. These were leather and leather products, lumber and wood products, and foundries and castings. They would be handled later.

In the request for a supplemental appropriation, Hollomon asked for \$3.8 million and received \$665 000 from the Congress.<sup>131</sup> The following spring he went before the House Appropriations Committee to ask for enough to make the program a \$7.4 million effort. Hollomon should have known that he was in trouble when Chairman Rooney of New York, angered by the supplemental subterfuge, refused to address him as "Doctor." The exchange went as follows:

MR. ROONEY: Did I not read something over the weekend that we should not call doctors "doctors" anymore? . . . Did you read something about that?

MR. HOLLOMON: No, sir; I did not.

MR. ROONEY: It pointed out that the only ones entitled to be called doctors are M.D.'s and D.D.S.'s. We have a government of doctors now.<sup>132</sup>

And for the rest of his testimony Hollomon did not receive the honorific.

---

<sup>129</sup> House Committee on Appropriations, Subcommittee on Department of State, Justice, and Commerce, the Judiciary, and Related Agencies Appropriations, *Departments of State, Justice, and Commerce, the Judiciary, and Related Agencies Appropriations for 1964: Hearings Before a Subcommittee of the Committee on Appropriations, House of Representatives, 88th Cong., 1st sess., National Bureau of Standards, 25 February 1963: 750.*

<sup>130</sup> *Ibid.*, 755.

<sup>131</sup> Appropriations Hearings for 1964: 764; *Supplemental Appropriation Act, 1963, U.S. Statutes at Large, 77 (1963): 35.*

<sup>132</sup> Appropriations Hearings for 1964: 763.

Hollomon came a cropper on building research. His written justification stated that the NAS-NRC report *A Program for Building Research in the United States* and the report on the same topic by the White House Panel on Civilian Technology "provide[d] the technical framework for this program." Then it continued, "Special studies will be performed to bring new technology to bear on ways to establish man's physical environment. For instance, more economic solutions to the needs for the control of humidity, ventilation, temperature, sound, and light, require the cooperation of several disciplines and industrial segments."<sup>133</sup> Widely perceived to mean that the program would engage in innovation and technology development, these statements brought serious criticism from members of the industry. William H. Scheick, executive director of the American Institute of Architects, wrote to Chairman Rooney, "We are absolutely opposed to the use of Federal Government funds for any support, by matching funds or otherwise, of research projects connected with the innovation or development of building materials or products by industry, trade associations, or of individual firms."<sup>134</sup> Richard H. Tatlow III, chairman of the NAS-NRC Building Research Advisory Board which had prepared the building research report, wrote to Frederick Seitz, chairman of NAS, "The Board specifically concluded that there is no identifiable need for Government to concern itself directly with industrial product or process innovation, and that any effort to do so could very easily upset the sensitive balance within the industry."<sup>135</sup> But these were mere love pats compared to the cudgeling by Douglas Whitlock, chairman of the board of the Structural Clay Products Institute. A close friend of Congressman Clarence Bow, ranking Republican member of the Appropriations Committee, Whitlock testified for the U.S. Chamber of Commerce. After extensive criticism of the program, he concluded, "The national chamber opposes the creation of a subsidized research and development program in the construction industry and recommends that the subcommittee reject this portion of the proposed civilian industrial technology program."<sup>136</sup> As if this were not enough, Congressman Bow attacked the program on the floor of the House:

I want to call the immediate attention of the Congress to a clumsy and highly suspect attempt by a major Federal agency to undertake on behalf of the vast U.S. construction industry and without its invitation, participation, or guidance, an ill-conceived and ill-defined research program that would tamper with the delicate free enterprise mechanisms of that highly competitive \$80-billion-a-year industry."<sup>137</sup>

---

<sup>133</sup> *Ibid.*, 755-756. The report of the White House Panel on Civilian Technology, "Technology and Economic Prosperity," was delivered to President Kennedy on December 3, 1962. The authors were Luther H. Hodges, secretary of commerce; Walter W. Heller, chairman, Council of Economic Advisors; and Jerome B. Wiesner, special assistant to the president. (DOC; Assistant Secretary for Science and Technology; Accession 40-72A-7166; Box 10; Folder Internal and Miscellaneous)

<sup>134</sup> *Ibid.*, 774.

<sup>135</sup> *Ibid.*, 780.

<sup>136</sup> *Ibid.*, 1538.

<sup>137</sup> *Congressional Record*, 88th Cong., 1st sess., 1963, 109, pt. 2: 2754.

This criticism from the building industry, along with that from other industrial groups, left the CIT program floundering; it had not sunk, but neither was it sailing very fast.<sup>138</sup> The Senate-House conference allowed a new appropriation of \$1 million in addition to the \$665 000 already appropriated in the "supplemental." This was to be used for the textile industry which, unlike housing, faced intense international competition and did not oppose government help in innovation. But the funds were pointedly made available only for the completion of the program, and no funds were allotted for any other purpose.<sup>139</sup>

The program was to have been a Department of Commerce one located in Hollomon's office. It would not be a laboratory-based activity but one that made grants to universities and other institutions. Thus, aside from giving advice to the assistant secretary, the Bureau would be treated as any other prospective contractor, receiving perhaps \$100 000 or so primarily for the dissemination of technical information to the industry. Astin quite properly felt that the Bureau could not on the one hand be an agency that made grants, and on the other be a grantee.<sup>140</sup> However, with the reduction of the program and its limited duration, the Civilian Industrial Technology program, now concerned solely with textiles, was established at the Bureau in FY 1964. It remained until 1970 when the program ended after expenditures totaled \$1.37 million.

During its stay, the program was directed by the Textile and Apparel Technology Center in the Institute for Applied Technology. Except for a small contract with the Applied Mathematics Division, all the funds were let in contracts with external organizations. The work was a combination of applied research and infrastructure development. A few examples illustrate its nature.<sup>141</sup> A contract for a study of fiber surface properties in relation to textile products and processing was awarded to the Textile Research Institute, Princeton, New Jersey. A small award was made to the Fashion Institute of Technology in New York to survey the possibility of setting up programs that would bring new technical information to the apparel industries. This small program led to the establishment of the American Apparel Manufacturers Association, which was formed under another contract but became self-sufficient. A 2-year program at MIT was designed to provide managers and research engineers with a bibliography of the world literature on mechanical processing of textiles. The MIT program developed a thesaurus that provided a link to the scientific literature.

---

<sup>138</sup> Katz, *Presidential Politics*: 140.

<sup>139</sup> D. S. Greenberg, "Civilian Technology: Program to Boost Industrial Research Heavily Slashed in House," *Science* 140 (June 28, 1963): 1380-1382.

<sup>140</sup> Appropriations Hearings for 1964: 774-775.

<sup>141</sup> R. L. Stern, "Current Status of Program Activities and Proposals Under the Textile and Apparel Technology Center." (DOC; Assistant Secretary for Science and Technology; Accession 40-68B-6087; Box 53; Folder Correspondence 1965-66 Filed by Bureau: (b) National Bureau of Standards—General 1966)



## **A Bold Proposal Leads to a Major Reorganization**

Astin had pondered deeply the role of the Department of Commerce in science and technology. Somewhat more than a year after the report of the second Kelly Committee, and while a program for civilian technology was being discussed in the White House, the Bureau director made a bold proposal to then Secretary of Commerce Luther Hodges. It was transmitted to Hodges on August 30, 1961, under the rather cumbersome title "A proposal to strengthen the role of the Department of Commerce in the promotion and development of the Nation's commerce and industry by means of a systematic stimulation and utilization of science and technology."

While agreeing with the second Kelly Committee that science and technology were important to the department's primary functions, Astin did not feel that simply strengthening the existing activities of the department went far enough, but that "the great dependence of commercial and industrial growth upon science and technology requires a more unified and dynamic approach." He made the hardly contestable argument that modern industry depended on new products and processes based on engineering advances, and that those advances were based, in turn, on scientific developments. Thus, in order to carry out its mission of stimulating and fostering commerce and industry, the department had to be deeply concerned with science and technology.<sup>142</sup>

Now, there were other departments for which science and technology were of fundamental importance. These were Defense; Agriculture; and Health, Education and Welfare through its National Institutes of Health. Each of these had far-flung, highly coordinated and successful research efforts in furtherance of their missions to provide, respectively, for the Nation's defense, its agriculture, and its health. With regard to the DOC, however, Astin wrote, "In spite of the fact . . . that new industries and related commercial activities have been major users and exploiters of scientific research and development, we find no comparable program within the government department entrusted with promoting the Nation's commerce and industry." True, there were activities in various bureaus, and these were important, but they fell far short of "a leadership-type utilization of the impact of science upon commerce and industry."

Moreover, competition among nations shaped Astin's consideration of the department's role in science and technology. According to Astin, while "most industrial research and development has been and most likely will continue to be privately supported there are increasing numbers of important new areas where government stimulation and support are necessary. Industrial strength and technological leadership are such important parts of national policy that the Federal Government can afford to do no less here than in [Defense, Agriculture, and Health]."

As a result of this reasoning, Astin proposed that the DOC establish a major new research and development agency called the National Institutes for Physical Sciences (NIPS). Clearly modeled after NIH, these institutes would have as their primary purpose "the stimulation, conduct and support of scientific research and development that are important to industrial and commercial activities, and not adequately provided"

---

<sup>142</sup> Memorandum, A. V. Astin to L. H. Hodges, "A Proposal to Strengthen the Role of the Department of Commerce." August 30, 1961. (NARA; RG167; Astin file; Box 14; Folder untitled).

for either by Government or the private sector. Then Astin listed six specific functions of the new organizations: (1) The operation of research institutes in major areas of industrial technology, such as new materials, automation and production processes, construction, transportation, communication, fire research, quality control, and engineering standards; (2) the operation of a national center to provide services to science and technology in such areas as measurement services, high-precision data, and information; (3) the provision of technical services, such as research and development, surveys and advisory assistance to other agencies of the Government; (4) the conduct of research in areas of engineering or physical science not sufficiently supported in other parts of the Government; (5) the support in private institutions through contracts or grants of applied research of importance to industrial and economic growth; and (6) the operation in the DOC of bureaus whose programs are primarily scientific or technical.

Astin had in mind that all of the work of the Bureau would be included and expanded in the new institutes along with that of some of the other bureaus of the department. And some new functions would be added. In fact, the first three of the enumerated functions were already being carried out at the Bureau in manners ranging from complete and profound to rudimentary. The fourth was clearly meant to provide for the "special missions" activities that so concerned Astin, while the fifth was a completely new departure, for the Bureau had never been a contracting or granting agency. Finally, the last function was meant to accommodate the scientific work in other agencies of the department, primarily the Weather Bureau, the Census Bureau, the Patent Office, the Coast and Geodetic Survey, and the Office of Technical Services. Thus the Bureau and, to a lesser extent, the other agencies of the department would provide the source or nucleus for a number of institutes. The unique measurement-standards function would become an institute, while the Bureau's work on materials could provide the nucleus for a Materials Institute. The CRPL could become an Institute for Communications Research, and Building Research could develop into a Construction Institute. Data Processing could give birth to an Automation and Control Institute, and product testing could be included in a Quality Control and Engineering Standards Institute.

The relation of the institutes to the National Science Foundation was, of course, a matter of concern. Astin felt that rather than competing with NSF's mission of supporting basic research, the institutes would complement that agency since they would primarily support applied research and "operate such basic physical science laboratories as are beyond the scope of the Science Foundation's non-operational mission." His proposal would provide a means for the conduct of "technological activities which do not fall clearly within the responsibilities of existing science agencies," and preclude the often-suggested formation of a Department of Science.<sup>143</sup> He cited examples of how the department and the Bureau had frequently been asked to undertake work that did not result directly from their missions and, thus, were already performing some of the functions of a Department of Science.

<sup>143</sup> "Senate Committee on Government Operations: Press Release," from Senator John L. McClellan and Senator Hubert H. Humphrey, Subcommittee on Reorganization, January 20, 1958. This was the most recent proposal for a Department of Science when Astin made his proposal for a National Institutes for Physical Sciences. (DOC; Assistant Secretary for Science and Technology; Accession 40-76-4; Box 1; Folder State Federal Technical Services Act)

The kind of organization that Astin had in mind is further clarified by his wistful statement, "A proposal for establishing such National Institutes is made with mixed feelings on my part since it involves, if accepted, a loss of most of the present programs of the NBS and at least a major part of its present identity. Also, the NBS would be at a lower organizational echelon than it is now." Clearly, Astin referred to a loss on the Bureau's part of its basic measurement standards activities for these would become an institute in the new structure. His NBS would not become NIPS but only a piece of it.

Astin asked for permission to work with the assistant secretary designate and the other agencies of the department on this matter. By the time he took office, Hollomon had already heard about Astin's proposal. When Astin spoke before the White House Panel on Civilian Technology he appears to have presented at least some of his own ideas for NIPS.<sup>144</sup> Hollomon was the immediately preceding speaker on the program and it is safe to assume that he had stayed to hear Astin. Then, less than two months after Hollomon assumed his duties, Astin answered a request from the secretary on how the Bureau could respond to the department's program of promoting economic growth by recommending that the department move rapidly in the direction pointed out in his NIPS proposal.<sup>145</sup> He noted that he had had discussions with Hollomon on the matter and was detailing Associate Director Irl Schoonover to work full time with Hollomon to develop a "specific plan for action."<sup>146</sup>

Exactly what happened between Schoonover and Hollomon may never be known. Schoonover's many virtues did not include writing (nor often reading) memoranda. He much preferred face-to-face discussions and man-to-man deals closed with a handshake. As a result of these predilections and the natural propensity to keep delicate negotiations secret, no written record of the interaction has been found despite assiduous searching. The account to be given has been pieced together from the oral histories of Astin, Schoonover, and Huntoon, as well as from discussions with persons such as John D. Hoffman, Robert L. Stern, and Churchill Eisenhart, who were in positions to know something of the negotiations.

---

<sup>144</sup> The title of Astin's talk was "New Goals for the National Bureau of Standards: A National Institute of Applied Science and Technology." Letter with attachment, Michaelis to Astin, February 19, 1962. (NARA; RG 167; Astin File; Box 14; Folder untitled)

<sup>145</sup> Memorandum, A. V. Astin to L. H. Hodges, "'Will it Promote Economic Growth?' Program," June 25, 1962. (NARA; RG167; Astin file; Box 36; Folder A. Secretary of Commerce 1953. 1961)

<sup>146</sup> Astin had to be careful in his choice of a person to work with Hollomon. While respected for his intellect, Hollomon was variously described by many as domineering, contentious, arrogant, and disdainful, and he quickly caused antagonism in many people. In fact, it was these character traits that alienated some congressmen and members of industry, and were partly responsible for the failure of the CIT program. (Katz, *Presidential Politics*: 140). Schoonover, called "the swamp fox" by his acolytes and possessor of a great sense of humor, could work with Hollomon. Indeed, some who were able to work with him found him a hard taskmaster but one who could improve their performance.



Irl C. Schoonover joined the staff of the Bureau in 1928 as a junior chemist and eventually served in such positions as chief of the Dental Materials Section, chief of the Polymer Structure Section, chief of the Mineral Products Division, associate director for planning, acting director of the Institute for Materials Research, and deputy director. Schoonover played a pivotal role in creating the Bureau's modern materials research program.

Hollomon was very much taken with Astin's NIPS concept, and it influenced his thinking with regard to the interaction between Government and industry in stimulating innovation and the development of technology as articulated in his CIT proposal. Thus, from the very beginning, Hollomon wanted an entity called the Institute for Applied Technology (IAT) included in NIPS to carry out his aims. The rest of the proposed organization was a matter for negotiation. It appears that at one time the proposal was made that there be a National Bureau of Standards consisting of essentially all the measurement-standards work, and an Institute for Applied Technology containing essentially everything else. This view is confirmed in a letter from Kelly to Astin following a meeting of the NBS Visiting Committee, which Kelly chaired. He wrote, "You will note, especially my letter to the Committee members, that I am somewhat concerned with your report on the planning and progress for new scientific programs in the Department of Commerce. I am especially concerned about the possible inclusion of the Bureau as a component of an Institute of Civilian Technology. If this becomes a matter of serious consideration, I certainly believe that those familiar with the Bureau's

operations and knowledgeable as to the value of the 'standards' function should have opportunity to comment."<sup>147</sup>

Moreover, there was the serious question of the autonomy of the institutes. Hollomon appears to have pushed for their total budgetary independence so that they would receive separate budgets which he could then control. The skeptical Bureau side feared that Hollomon would re-direct the funds so as to continuously enlarge IAT. Probably seeing that his concept of a NIPS would not be fulfilled, Astin vetoed this idea, and because of the strong position he occupied as a result of the battery additive controversy, such a veto could not be argued with.

As an almost incidental point during the negotiations, the name National Institutes for Physical Sciences (NIPS) was changed to National Institutes for Science and Technology (NIST), a title more in keeping with what both Astin and Hollomon had in mind. While neither of these names was ever adopted, the new acronym would arise again twenty-six years later when the National Bureau of Standards itself, with new legislation, became the National Institute of Standards and Technology. Many of the functions envisaged for NIPS/NIST would be incorporated into the resulting institution.

What resulted from more than a year of discussions was not the formation of the National Institutes for Science and Technology, with NBS as a part of them, but instead, a Bureau reorganized into institutes. The announcement of the reorganization was made on January 30, 1964.<sup>148</sup> There would be an Institute for Basic Standards (IBS), an Institute for Materials Research (IMR), and the Central Radio Propagation Laboratory (CRPL) with institute status, all of which already existed at the Bureau. An addition was the Institute for Applied Technology (IAT), which was Hollomon's creation. Each institute would have its own director who, along with a director for administration, would report to Astin, the director of the National Bureau of Standards.<sup>149</sup> This name, however, would be subtitled so that the full name of the organization would become "The National Bureau of Standards Institutes for Science and Technology." The subtitle, though, would only rarely be used and was soon forgotten.

The directors of the institutes would have considerable authority. Each would be responsible for the direction, execution, and evaluation of the programs of the institute, and each would have a deputy who would assist in the direction of the institute and "perform the functions of the Director in the latter's absence." The directors of the institutes that arose directly from the Bureau's organization were long-standing members of the Bureau staff. Thus, Robert D. Huntoon became director of the Institute for Basic Standards, relinquishing his position as deputy director of the Bureau in the process. The director of the Institute for Materials Research was Irl Schoonover, in an acting capacity. He also served as deputy director of the Bureau. No change occurred in the Central Radio Propagation Laboratory under Gordon Little. The director of the

---

<sup>147</sup> Letter, M. J. Kelly to A. V. Astin, June 22, 1962. (NIST RHA; Director's Office file; Box 354; Folder 1962-Visiting Committee)

<sup>148</sup> Department Order 90 (Revised), Manual of Orders Part 1, January 30, 1964. (NIST RHA; Director's Office file; Box 383; Folder NBS Organization DO 90, 1964-1968)

<sup>149</sup> An organization chart is given in Appendix I.

Institute for Applied Technology was Donald A. Schon,<sup>150</sup> who, however, was new to the Bureau, having been brought by Hollomon to this new position from his post as director of the department's Office of Technical Services. Rounding out the new slate of the leaders of the Bureau was Astin's long-time associate, Robert S. Walleigh, who served as director of administration, and Russell B. Scott, who remained as manager of the Boulder Laboratories.

Each of the institutes contained divisions that were generally unchanged in structure from what they were before the reorganization, and there were no real surprises in their disposition. Besides the six divisions concerned with basic measurement standards, Applied Mathematics, the recently formed Physical Chemistry Division, and Laboratory Astrophysics were placed in the Institute for Basic Standards, as were two of the Boulder divisions, Radio Standards Physics and Radio Standards Engineering. IBS also contained the Office of Standard Reference Data. The Institute for Materials Research contained the three materials divisions plus Analytical Chemistry, which dropped "Inorganic" from its former title, Boulder's Cryogenic Engineering Laboratory, and the newly formed Reactor Radiations Division. It also contained the Office of Standard Reference Materials, which was in charge of utilizing the technical resources of the Bureau for the production of Standard Reference Materials, the new name for the old standard samples. The Central Radio Propagation Laboratory was unchanged but achieved institute status. As outlined in DOC Order Number 90, the mission of the Institute for Applied Technology was to "provide a variety of industry-oriented technical services to facilitate and promote the use by industry of available technology and to facilitate technology innovation." Its main functions were to identify and evaluate obstacles to technical innovation by industry; to develop a technical base for the evaluation of technological products and services; to maintain cooperation with public and private organizations producing technological standards such as codes, test methods, and engineering standards; and to disseminate technical information. It consisted of four offices, one center and six divisions. The Office of Technical Services was primarily a clearinghouse located in the department for the collection and dissemination of technical information from all sources, making the results of science and technology more readily available to industry, commerce, and the general public. The Office of Industrial Services operated the Bureau's industrial research associate program and worked with outside organizations to stimulate innovation. The Office of Weights and Measures was responsible for technical services to the states, business, and industry in the area of measurements; the design, construction, and use of standards of weights and measures and associated instruments; and the training of state and local weights and measures officials. The Office of Engineering Standards

---

<sup>150</sup> Born in 1930 in Boston, Donald Schon received a B.A. degree from Yale in 1951 and a Ph.D. from Harvard in 1955. He taught at the University of California and the University of Kansas City for three years, then joined the Arthur D. Little Company as director, New Products Group. He stayed in that position for six years, and in August 1963 went to the Department of Commerce as director of the Office of Technical Services, from which post he came to the Bureau. An expert on innovation, he authored a book, *Displacement of Concepts* (London: Tavistock, 1963), on invention and discovery.

worked with the voluntary standards system of the country, coordinated the Bureau's activities in it, and provided a forum in which interested parties could write standards. The Textile and Apparel Technology Center operated the residue of the CIT program at the Bureau. Three of the institute's divisions were already in existence in the Bureau. These were the Building Research Division, the Information Technology Division (formerly Data Processing Systems), and the Instrumentation Division. The new arrivals were the Industrial Equipment Technology Division, which had the ambitious mission of doing with all industrial equipment what the Data Processing Division did with information equipment. The Performance Test Development Division was an outgrowth of the Bureau's product testing and evaluation activities. Finally, the Transport Systems Division's mission was to develop "methodology and models to permit measurement and evaluation of the engineering, economic, and social factors essential to the understanding of the transportation function and to decision making on national transportation policies."<sup>151</sup> To many members of the Bureau staff long accustomed to an organization based on scientific laboratory work, the new institute was an enigma since it was based partly on research (most of it applied), partly on testing and test method development, partly on funding work in outside organizations, and partly on paper studies.

The new organization was not well accepted by many members of the staff. A new layer of management had been added just above the division chief, thereby removing everyone one level further from the director. Of course, reorganizations had occurred periodically in the Bureau's history, but these involved no more than reorienting, replacing, or adding divisions or sections. This was the first reorganization in the Bureau's history that involved a structural change in the institution, and it caused apprehension. But the old structure could not continue; the Bureau had simply become too big. There were twenty-three divisions just before the formation of the institutes. To have that many division chiefs reporting to the director clearly placed too great a burden on him. Indeed, this situation had been foreseen by the first Kelly Committee which recommended that associate directors be given more line responsibilities, thereby lessening the burden on the director. That end had been achieved, albeit in a then-unforeseen manner.

Considering that Astin's NIPS/NIST proposal and Hollomon's CIT program had different origins, it is not surprising that there were striking differences between the two. Astin's proposal was basically structured as a development and expansion of the Bureau program, incorporating into it the functions of other agencies of the Department of Commerce. It was thus oriented toward the support of the specific areas of science and engineering which Astin viewed as the source of industrial innovation and development, and was very much concerned with the stimulation of new industries by the support of science and technology. The resulting program was largely laboratory-based. The White House/Hollomon program, on the other hand, was directed toward specific older industries that were viewed as lacking in innovation and technological

---

<sup>151</sup> Department Order 90 (Revised).

development. While research in these industries would be supported, the main object was to change their scientific infrastructure. Even in the provision of information—the element common to the two proposals—there were differences. Astin speaks of “acquisition and compilation of precision data and scientific information centers,” while Hollomon speaks of “dissemination of technical information in a useful form to the particular industry.” That such differences would arise was inevitable. Hollomon did not have to concern himself with the maintenance of services provided by the Bureau; they would continue after CIT. Yet, despite these differences, both proposals had the same goal: to find a means by which Government and industry could interact in the realm of science and technology to stimulate economic prosperity. It was a theme that had concerned the Bureau since the end of World War I<sup>152</sup> and one that would arise continually for the remainder of the period covered in this history.

## THE TECHNICAL WORK

In the seven years following the sputniks, administrative changes were made in response to the recommendations of the two Kelly Committees and to the changing face of science and technology. Old divisions were substantially reorganized and their directions changed. New types of organizational units—the Office of Standard Reference Data and the Joint Institute for Laboratory Astrophysics—were added. Missions were pondered and clarified. Fortunately for NBS, the sputniks triggered substantial increases in appropriated funds, and part way through the period directly appropriated funds exceeded transferred funds for the first time since World War II. All these changes culminated in the first major structural change in the Bureau organization.

But the value and efficacy of the Bureau to the Nation was not determined by its organizational structure, nor by statements of its mission. NBS was, first and foremost, a laboratory-based institution, and in the final analysis it was the output of its laboratories that determined its value. This part of the chapter is an account of the technical work during the period, emphasizing new directions and accomplishments. Again, illustration is by example rather than a complete discussion of the technical work.

## STANDARDS MATTERS

### Length

Frank T. Bow, congressman from the industrial state of Ohio and a member of the House Appropriations Subcommittee, was interested in the accurate measurement of length. At the Bureau's appropriations hearings for FY 1957 he asked Allen Astin, “Dr. Astin, as you know, I am interested somewhat in the measurement of tolerances, particularly in the bearing industry as they relate to their work on guided missiles and other functions. What are you doing at the Bureau now in the development of measurement to closer tolerances?”

---

<sup>152</sup> See, for example, Chapter 5 of Cochrane, *Measures for Progress*: “The Tide of Commerce and Industry (1920-30).”



Astin, never loath to seize an opportunity to publicize the Bureau's work, replied, "Many of our programs could be grouped in this general category. . . . I think you are specifically interested in the area of precise length measurements, particularly in the use of precision gage blocks?" to which Mr. Bow replied, "That is right."<sup>153</sup>

The Bureau had, in fact organized a program to decrease the calibration tolerance on the best grade of gage blocks from  $\pm 2 \times 10^{-6}$  in/in to ( $\pm 1 \times 10^{-7}$  or  $\pm 2 \times 10^{-7}$ ) in/in. The reason for this new reduction was that industry was anticipating the need for measuring to ( $\pm 1 \times 10^{-6}$  or  $2 \times 10^{-6}$ ) in/in, when it was at that time measuring to  $\pm 2 \times 10^{-5}$  in/in. But gage blocks cannot be used to measure to their indicated tolerance. A factor of 10 is allowed to compensate for dimensional instability caused by aging and by wear, and for errors introduced when combining two or more gage blocks. Thus the need for blocks with a length tolerance of  $\pm 2 \times 10^{-7}$  in/in.

There were two principal problems in developing such ultra-precise gage blocks.<sup>154</sup> One was simply the problem of measuring their length, and the other was the problem of dimensional stability. Because temperature is extremely critical,<sup>155</sup> the thermal conductivity of the master block should be as close to that of the object being calibrated as possible. Since the latter is either a working block or a measuring instrument, both of which are usually made of steel, the master block is pretty much constrained to be made of steel. Moreover, block specifications require that the gaging surfaces of the block be quite hard, which means that the steel be a hardenable alloy or that the surfaces of the block be hardened by some type of special treatment, such as nitriding. Because alloy steels are inherently unstable materials, their dimensions may increase or decrease with time. Making them stable is a complex metallurgical problem.

To solve this problem, a joint program involving the Optics and Metrology and the Metallurgy Divisions was begun. Sixteen companies, including experienced firms such as Brown & Sharpe, General Electric, IBM, Pratt & Whitney and Timken Roller Bearing, provided consultation, materials, facilities, and personnel for lapping, as well as a portion of the operating funds.

The scheme of the work was simple in concept but not easy in execution. The metallurgy team, headed by Melvin R. Meyerson, ordered fully annealed bars of various steels with a cross section of 1.5 in  $\times$  0.5 in prepared by the manufacturer, along with one set of gage blocks made of aluminum oxide. At the Bureau the bars were cut into blanks, given heat and/or surface treatments, and manufactured into gage blocks with gaging lengths of 2 in. Fifteen different materials were used, leading to forty-one combinations of materials and treatments. All machining was done in the Bureau shops except the final lapping, which was done by several commercial firms:

<sup>153</sup> House Committee on Appropriations, Subcommittee on Department of Commerce and Related Agencies, *Department of Commerce and Related Agencies Appropriations for 1957: Hearings Before a Subcommittee on Appropriations, House of Representatives*, 84th Cong., 2d sess., National Bureau of Standards, 20 March 1956: 107. The Bureau reported progress on this problem to the Appropriations Subcommittee each year until 1962.

<sup>154</sup> Most of this description comes from M. R. Meyerson, T. R. Young and W. R. Ney, "Gage Blocks of Superior Stability: Initial Developments in Materials and Measurement," *Journal of Research of the National Bureau of Standards* 64C (1960): 175-207. A shorter version by the same authors is "The Development of More Stable Gage Blocks," *Materials Research and Standards* 1 (1961): 368-374.

<sup>155</sup> A temperature change of 0.03 °C produces a change in length of  $10^{-7}$  in/in.



Melvin R. Meyerson of the NBS Metallurgy Division removed type 52100 tool-steel gage blocks from a chloride bath where they were immersed at 1550 °F for 15 min.

Brown & Sharpe, Dearborn Gage, DoAll, and Pratt & Whitney. Extensive metallurgical observations of microstructure and hardness were made by the Bureau staff. These blocks were then stored and their lengths measured periodically by members of the Optics and Metrology Division.

The metrology team under the leadership of Theodore R. Young had a different set of problems. They had to devise a means of measurement yielding a precision of one in ten million without going to absolute determinations, which would be impractical with this volume of work. As a result, an optical comparator was built according to a design described in the literature. Using as a reference standard an existing block—one which absolute measurements over a period of years had shown to be particularly stable—it was possible to obtain the desired precision. But even this effective technique

was not sufficient to handle the measurement load for the program, for a minimum of four hours per measurement was necessary to obtain thermal equilibrium. To alleviate this problem, an electro-mechanical comparator was acquired and was used along with a system by which the master block was used only to determine the length of one of a group of blocks, all of which had received the same thermal history. Even with this complex system, special mathematical handling of the data was required. Indeed, it was found that it made a difference how the two blocks to be compared were picked up in practice and held in the gloved hands of the operator. Results were different



Grace Chaconas of the NBS Optics and Metrology Division positioned a pair of gage blocks in a mechanical comparator. Such comparisons, carried out in accordance with a specially designed statistical procedure, provided data on the stability of gage blocks being developed by the Bureau.

when the blocks were held by the narrow, rather than the broad faces. This was ascribed to the temperature effects caused by the position of the operator's palms with respect to the two blocks.

The final result of these various investigations was to show that it was possible to produce—and measure—gage blocks with a precision an order of magnitude better than was previously possible. Blocks of specially prepared type 410 stainless steel measured over a period of more than a year showed a maximum variation in length of  $2 \times 10^{-7}$  in per year, and in some cases even less. Blocks of specially hardened type 52100 tool steel were equally good. These results achieved the objectives set out at the beginning of the program.

At the Appropriations Committee Hearings in 1961, Deputy Director Robert D. Huntoon—Astin being absent due to illness—was able to announce: “For the first time in NBS history, the Bureau has certified the accuracy of length measurements on commercial gage blocks to better than 1 part in 5 million.”<sup>156</sup> It was a fitting conclusion to a well-conceived and well-executed program.

At the same time that work was progressing with what might be called engineering standards for length measurement, momentous events were taking place on the primary-standard front. There had long been an effort to replace the venerable platinum-iridium meter bar that was the international prototype of length with a standard based on the wavelength of light emitted by a suitable element. Such a move would make redundant the international standard bar kept at the International Bureau of Weights and Measures (BIPM) in Sèvres, France. Any suitably equipped laboratory, with staff who had the time and the inclination, could have its own primary standard, for the prototype artifact of human construction would be replaced with a constant of nature available to all.<sup>157</sup>

Consequently, at the 1952 meeting of the International Committee on Weights and Measures in Paris, an advisory Committee for the Definition of the Meter was appointed. By 1954, the means of defining the meter in terms of the wavelength of light was agreed upon. By this time there had been sufficient comparisons of various wavelengths from different elements with the international prototype that it was agreed that no more would be carried out. Instead, the wavelength in a vacuum of the red line of natural cadmium was defined to be exactly 6438.4696 angstroms ( $10^{-10}$  m, or “tenthmeters”) and all measurements of the wavelength of other radiations were to be made by comparison with cadmium, a relatively easy task.

There were three serious proposals for the standard radiation. The Bureau proposed mercury-198 in an electrodeless lamp; the German Physikalisch-Technische Bundesanstalt (PTB) proposed the orange-red line from krypton-84, later changed to krypton-86 because of easier availability; and the Institute of Metrology of the U.S.S.R. proposed cadmium-114. The Bureau put lamps with each of these candidates into operation.

<sup>156</sup> Appropriations Hearings for 1961: 249. Huntoon's statement is somewhat misleading. While blocks could be compared with this precision, the absolute accuracy was not that high. (John Beers, private communication.)

<sup>157</sup> I. C. Gardner, “Light Waves and Length Standards,” *Journal of the Optical Society of America* 45 (1955): 685-690; “Wavelength of Kr<sup>86</sup> Light Becomes New International Standard of Length,” *Technical News Bulletin* 44 (1960): 199-200; Annual Report, 1961: 21-22.

At the 1960 meeting of the General Conference for Weights and Measures in Paris, the PTB candidate was accepted, and the wavelength of the orange-red line of krypton-86 became the new international standard of length. The new definition of the meter was 1 650 763.73 wavelengths of this light. A relative uncertainty of 1 part in 100 million was now possible for the measurement of length.

The Bureau was one of only two laboratories that had carried out a direct comparison of the krypton wavelength with the standard meter bar, the other being Canada. The Bureau results were slightly different from the proposed value, but the Bureau accepted it because the difference caused no practical problems and the new value made the angstrom exactly  $10^{-10}$  m. The old meter bars would remain as the principal means of performing calibrations. They had served the industrial world for almost 100 years as the primary standards of length. In less than twenty-five years, the new standard would be superseded by an even more precise definition of the meter based on the speed of light.



The U.S. delegation to the 1960 General Conference on Weights and Measures took a last look at the comparator on which prototype length standards from around the world were compared with the former international standard: the French platinum-iridium bar. From left to right: Louis Polk, president of The Sheffield Corporation; Allen V. Astin, NBS director; and Elmer Hutchisson, director of the American Institute of Physics.



Karl F. Nefflen of the Engineering Metrology Section assembled a krypton-86 lamp. The lamp was maintained at the triple point temperature of nitrogen, 63 K, to improve the reproducibility of the standard wavelength.

In another aspect of engineering metrology, a method of accurately measuring long light paths was being explored. High-accuracy surveyor's tapes such as those used in surveying missile tracking sites, were calibrated with a relative uncertainty of 1 part per million. The use of lasers was expected to improve the precision of those measurements. For this purpose, a helium-neon laser constructed at the Bureau was made to operate in a single mode, thereby providing a single narrow wavelength of light. The laser operated in the infrared at a wavelength of  $11\,523\text{ \AA}$ , and required an image converter to make it visible. The laser light was passed through a specially designed Michelson interferometer whose two reflecting mirrors were placed 100 m apart at the

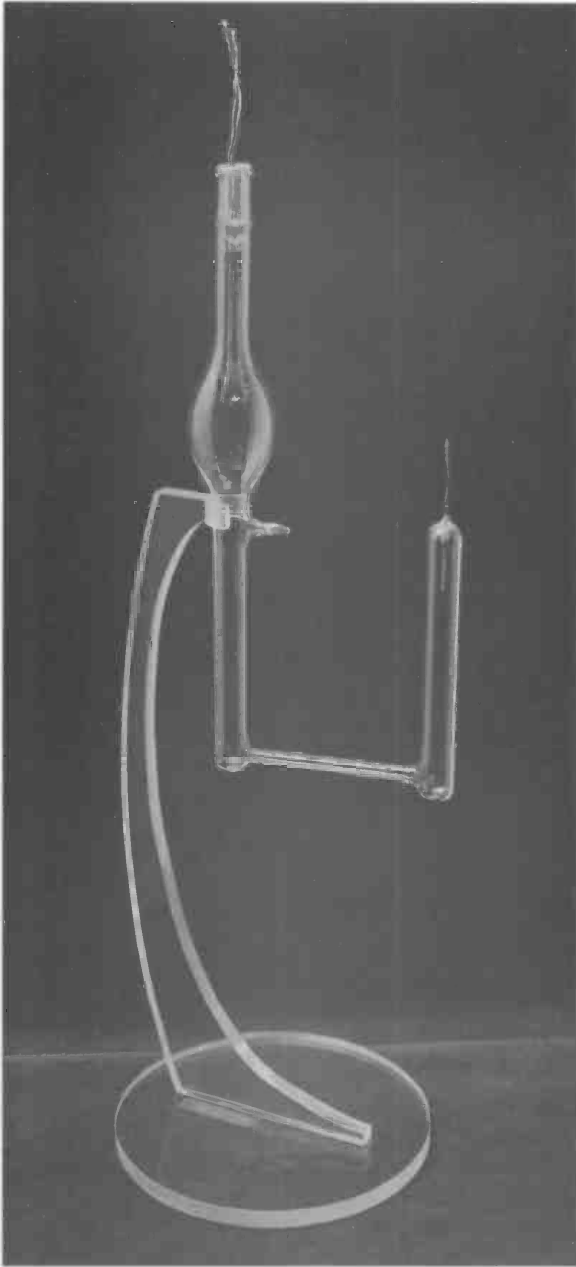

In 1960 a new definition of the meter, 1 650 763.73 wavelengths of orange-red light emitted from a krypton-86 lamp, was adopted at the General Conference for Weights and Measures in Paris. The meter, previously defined as the length between two marks on a platinum-iridium bar stored at 0 °C at the International Bureau of Weights and Measures in Paris, would in 1983 be redefined as the distance travelled by light in a vacuum during  $1/299\,792\,458$  of a second.

ends of the calibrating tape in the Bureau's tape tunnel. Fringes were obtained, and by counting the fringes in the span length it was in principle possible to relate the measurement directly to the laser wavelength. But the fringes were quite unstable because of vibrations and other disturbances, and the method required considerable

development. Nevertheless, the experiment demonstrated one of the first direct applications of the laser to metrology.<sup>158</sup>

### Temperatures High and Low

At the FY 1959 House Appropriations Hearings, Astin, as part of his presentation of Bureau achievements, announced the development of a new pyrometer for the measurement of temperatures above 2000 °C. This prompted Sidney R. Yates, congressman from Illinois, to ask Astin if it was true, as he had heard, that the Soviet Union was able to measure temperatures up to 6000 °C. Astin said that he had heard the same, but that the Bureau could measure reliably only up to 3000 °C and “by very impromptu means to 4200 °C. This is our current limit.”<sup>159</sup> With the advent of the sputniks still fresh in everyone’s mind and a technological rocket race with its need to measure high temperatures in rocket exhausts and re-entry vehicles well started, the committee was horrified that Astin had not been permitted to ask for facilities necessary for the attainment and measurement of higher temperatures. Thus, along with the approval of the full request the Bureau had made that year, came instructions from the committee in 1960 to devote \$1.16 million to “activities in the field of very high temperature” for FY 1961.<sup>160</sup>

The Bureau was in a good position to carry out that instruction.<sup>161</sup> Along with the pyrometry work, it had just completed a five-year exchange of platinum resistance thermometers with six other nations to determine the reproducibility of the steam point—the reproducibility was  $\pm 0.001$  °C—and with Canada of the sulfur point, 444.60 °C, where the reproducibility was  $\pm 0.002$  °C. NBS was actively working to extend the range of these thermometers to the gold point (1063 °C), thereby replacing the inherently less accurate platinum vs 90 percent platinum 10 percent rhodium thermocouples. Indeed, in his presentation at the FY 1960 hearings, Astin listed thirty-eight high-temperature projects. Besides projects on the production and measurement of high temperatures, he listed such activities as the properties of materials at high temperatures, spectroscopy and atomic energy levels, phase equilibria and high-temperature chemical and physical processes.

For temperatures above 1063 °C, the measuring instrument of choice was the optical pyrometer, and the Bureau was deeply involved in improving the accuracy of pyrometer calibrations in the critical range between 2500 °C and 4000 °C. For this purpose, both a stable source of high temperatures and an accurate measuring instrument were necessary. By 1960, zirconium and carbon arcs had been developed as a source for calibrations, but their instability limited the accuracy of routine calibrations to  $\pm 40$  °C at 3800 °C. Attempts to improve the stability centered on an electrically heated graphite tube in an inert gas atmosphere. The improvement in measuring instruments

<sup>158</sup> “NBS Laser Produces Interference Fringes,” *Technical News Bulletin* 47 (1963): 80-82.

<sup>159</sup> Appropriations Hearings for 1959: 417-418, 431-434.

<sup>160</sup> Appropriations Hearings for 1961: 262.

<sup>161</sup> Annual Reports: 1957, 23; 1958, 23-24; 1959, 29-30; 1960, 51-52; 1961, 51-53.



came in the form of a photoelectric pyrometer, which greatly reduced the human element in calibrations. In measurements at the gold point (1063 °C) this new instrument achieved a precision of  $\pm 0.02$  °C, better by a factor of 15 than a visual optical pyrometer. It was subsequently found that most of the problems with this pyrometer arose from drift in the tungsten strip lamp used for internal calibration of the instrument. More frequent calibration at the gold point corrected this problem. It was then possible to realize the International Practical Temperature Scale with reduced uncertainty. The uncertainty was now 0.07 °C at 1063 °C and only 1.9 °C at 3730 °C, a substantial improvement over previous performance.

At very high temperatures in the 10 000 °C to 20 000 °C range, a wholly new source of temperature and the means of measuring it became necessary. The source developed was a plasma arc, and the means of measurement was the width and intensity of

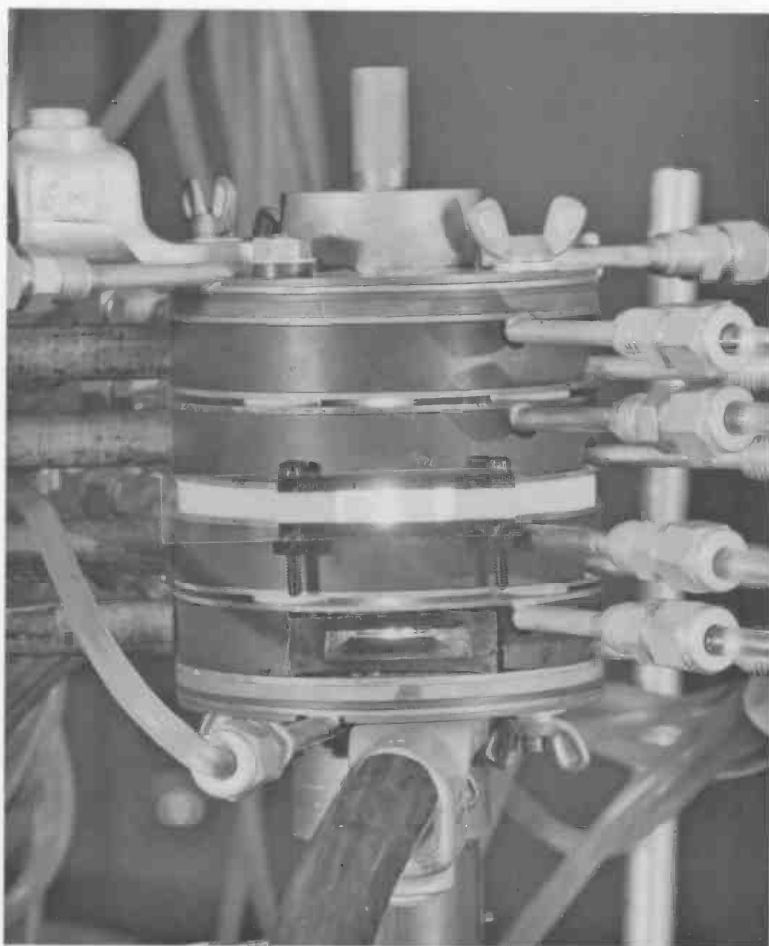

This 15 000 °K plasma arc apparatus was used at NBS to study methods of measuring very high temperatures.

spectral lines. This shows the clear relationship between spectroscopy and atomic physics data on energy levels and transition probabilities on the one hand, and plasma physics on the other. The new arc utilized electrodes that were shielded by argon from the gas to be studied. With nitrogen as the gas, the intensity of the spectral lines remained constant within 1 percent for an hour. The most interesting results, however, would be with arcs in hydrogen or helium, for then the radiation properties could be calculated theoretically, even though these arcs were much harder to stabilize. In any case, complex calculations were necessary, so an analog computer was developed and built so that they could be made "in real time." By the end of 1964, temperatures in the 20 000 °C range were being routinely measured, if a measurement requiring a houseful of equipment can be considered routine.

While all this work on measuring high temperatures was going on, low-temperature measurement standards were not being neglected.<sup>162</sup> The International Temperature Scale was defined down to 90 K, and to extend the range, the Bureau began developing a thermometer based on the velocity of sound in helium. Such an instrument would give an absolute measurement of temperature and make it competitive with the much-more-cumbersome gas thermometer. At the same time, various semiconducting resistance devices were being investigated as secondary thermometers.

In 1961, the Bureau announced its aim to provide a calibration service in the range 10 K to 20 K. The scale would be based on an acoustical interferometer with helium as the working fluid. This provided the necessary absolute measurements. "Doped" germanium resistors were to be used as precision secondary standards. When cycled between 300 K and the boiling point of helium—approximately 4.2 K—their resistances showed a reproducibility within  $\frac{1}{3}$   $\mu$ K. Helium-vapor-pressure thermometers would also be used.

In 1964 the first service was opened, providing calibrations in the range 2 K to 5 K. Calibrations could be made every 0.1 K against a group of germanium thermometers which in turn had been calibrated against the accepted helium-vapor-pressure temperature scale. In 1965, a facility for the calibration of germanium thermometers in the range 4 K to 20 K was opened. The calibration was based on an NBS temperature scale obtained with an acoustic thermometer and transferred to six germanium thermometers.

### High Pressures

In late 1958, Allen Astin received a report he had commissioned from consultant Leason H. Adams on a survey of high-pressure research at the Bureau. Along with the survey, the forty-page report made recommendations regarding future needs in this area.<sup>163</sup> The report concerned itself only with high pressures, defined as those from

<sup>162</sup> Annual Reports: 1959, 31; 1961, 56; 1962, 62-63; 1963-1964, 75-76; and 1965, 18-19.

<sup>163</sup> L. H. Adams, "Survey of Current High-Pressure Research Program at National Bureau of Standards and Recommendations Regarding Future Needs in this Area," Revised November 19, 1958. (NARA; RG 167; Astin file; Box 15; unfolded)

1000 bar to  $10^6$  bar (approximately 15 000 psi, to  $15 \times 10^6$  psi) and it recommended that first priority be given to the establishment of a pressure scale based on suitable fixed points, much as are used in the establishment of the International Practical Temperature Scale. It also recommended the study of properties of materials at high pressures to advance the attainment, maintenance, and measurement of high pressures; setting up and promoting pressure-safety regulations; the presentation of selected PVT data for liquids and gases; the development of instruments important in the pressure field; and the development of methods to extend high-pressure technology. Of all these recommendations, the only ones specifically adopted and emphasized were those on high-pressure standards and on the attainment of high pressures.<sup>164</sup> All the other activities recommended, save perhaps the one on safety, were already actively pursued and they apparently needed no special emphasis.

In 1959, the Bureau provided pressure calibration services over the range 5 psi to 60 000 psi. However, the Mechanics Division was hard at work expanding the scale. The main instrument of choice was the dead-weight loaded-piston gage that is not packed to prevent fluid from leaking—the so-called freely rotating piston gage. In this instrument the clearance between piston and cylinder is so small that the leak rate is a negligible  $1 \text{ in}^3$  or  $2 \text{ in}^3$  per month. Like the gas thermometer in temperature measurements, this is a first-principles instrument in which the pressure can be precisely calculated. It was anticipated that the working range of this type of instrument could be extended to 300 000 psi or 400 000 psi.

At the same time, the division was developing a multi-anvil cell to achieve higher pressures, but the pressure in this instrument could not be confidently and precisely calculated. The first of these instruments had four anvils in a tetrahedral arrangement and could reach pressures of approximately  $2 \times 10^6$  psi.<sup>165</sup> Moreover, it was a compact instrument that could be easily loaded into a mechanical testing machine because it was so designed that force needed to be supplied to only one of the anvils. Later a modification with six anvils in a cubic arrangement was designed and built. For use in these presses, a sample of the material to be studied is placed in either a tetrahedron or cube of an easily sheared pressure-transmitting material (liquids would turn to solids at these very high pressures) such as pyrophyllite (hydrated aluminum silicate). This assembly, along with any leads to measure electrical resistance, is placed between the anvils and force is applied.

There were several materials for possible use in generating pressure fixed points, which are basically phase transitions or crystal-structure transitions whose onset could be determined by some physical means, such as changes in electrical resistance or volume. The primary candidates for fixed points were the pressure at the freezing point of mercury at  $0^\circ\text{C}$  and three crystal-structure transitions in bismuth, two occurring near 27 kbar and a third at almost 120 kbar.

---

<sup>164</sup> "High-Pressure Standards Program Expanded," *Technical News Bulletin* 43 (1959): 241; Annual Report, 1959: 35.

<sup>165</sup> E. C. Lloyd, U. O. Hutton, and D. P. Johnson, "Compact Multi-Anvil Wedge-Type High Pressure Apparatus," *Journal of Research of the National Bureau of Standards* 63C (1959): 59-64.

Both the mercury and the bismuth points were investigated with the piston gage, which had to be carefully and tediously developed to extend its range. By 1963, pressure at the freezing point of mercury at 0 °C was determined to be 109 722 psi with an uncertainty of  $\pm 30$  psi, which was adequate for use as a calibration point. Moreover, a pressure measurement gage based on the resistance of manganin wire proved to be quite a good working gage.<sup>166</sup>

Development of the freely rotating piston gage continued, and by 1965 a gage with a tungsten-carbide piston diameter of only 0.080 in, and operated with a maximum load of 860 kg, reached the low-pressure bismuth transition. Believed to be the highest pressure yet achieved with this type of gage, and using volume change as an indication of the transition, the pressure obtained was 25 306 bar (approximately 367 000 psi) with an uncertainty of 60 bar.<sup>167</sup> It was the most accurate value so far obtained for the transition.

Thus, in seven years after announcing the pressure-standards program, a new pressure apparatus had been developed, two new piston gages had been built and, most important, two new pressures suitable for use as fixed points on the pressure scale had been determined. It was an impressive performance.

While all this "classical" work was going on, Elmer N. Bunting, Alvin Van Valkenburg, and Charles E. Weir, of the Mineral Products Division, were developing a totally new means of obtaining high pressures in collaboration with Ellis R. Lippincott, a guest scientist from the University of Maryland. Their main impetus was not the development of a pressure scale, although knowledge of the pressure was important to them, but rather the study of materials under high pressure. Specifically, they were interested in the determination of the infrared spectra of solids at high pressures as a means of studying atomic bonding. This placed an immediate and immense constraint on their apparatus, for it had to be transparent to infrared radiation. What appeared to be a great hindrance turned out to be an enormous boon.

From earlier infrared measurements on a large number of gem diamonds obtained from the U.S. Customs Service at no cost to the Government, Bunting and Van Valkenburg learned that certain rare types of diamonds, known as type II, were relatively transparent to infrared light, and, of course, like all diamonds, were very hard and strong.<sup>168</sup> These rare type II diamonds, of which they found several in the supply of gems, could be used for infrared microspectroscopy studies. Not much material was needed, so a very small portable apparatus for generating load was all that was necessary.

Their first attempt, which was to use a 7.5 carat diamond with a small hole through it containing steel pistons to compress the sample between them, was unsuccessful. A fundamentally new way to do this had to be found.

<sup>166</sup> Annual Report, 1963: 38-39.

<sup>167</sup> P. L. M. Heydemann, "The Bi I-II Transition Pressure Measured with a Dead-Weight Piston Gauge," *Journal of Applied Physics* 38 (1967): 2640-2644.

<sup>168</sup> E. N. Bunting and A. Van Valkenburg, "Some Properties of Diamond," *American Mineralist* 43 (1958): 102-106.

Percy W. Bridgman, the father of high-pressure research, had pioneered in the pressing of materials between two flat anvils as a means of applying pressure to them.<sup>169</sup> The Bridgman technique was applied to the new apparatus, and a device was built which made use of opposed diamond anvils. For this purpose, two gem-cut type II diamonds weighing approximately 0.036 g were selected from their abundant supply of contraband brilliant-cut stones. The culet (the tip of the conical part) of each stone was ground to form a facet parallel to the table (the large flat top part of the gem-cut diamond). The diamonds, now having become anvils, were placed in a mount with the facets facing one another in an opposed orientation. The material to be studied was placed between them and the two anvils were driven together with an ingenious lever-arm arrangement compressing a calibrated spring.

The two anvils were purposely selected to be slightly different in size, with the anvil area of the smaller used for calculation of the pressure. The first two devices made had anvil areas of 0.000156 in<sup>2</sup> and 0.000182 in<sup>2</sup>. It is clear that a pressure of 100 000 psi required the small forces of 15.6 lb and 18.2 lb, respectively. In fact, one of the first instruments built was estimated to have reached a calculated pressure of 16 GPa. This pressure was later shown by the ruby pressure measurement method to be extremely overestimated. A pressure of only 5 GPa had been attained. The pressure cell was a small device that could be held in the palm of one's hand, and microscopic observation of the material under pressure was easy and routine.

The first pressure cells were used to study infrared spectra of solids, and development of the cell was rapid.<sup>170</sup> Later, Van Valkenburg developed a method to confine liquids by using a thin (10 mil) sheet of Inconel 600 metal containing a tiny hole (12 mil diameter).<sup>171</sup> The liquid was placed in the hole and squeezed between the two anvils; it was used to observe pressure-induced phase changes in liquids and also solids immersed in liquids. A new hydraulically operated design permitted taking x-ray-diffraction powder patterns. High-pressure single-crystal studies developed as a result of a meeting convened by Howard F. McMurdie, chief of the Constitution and Microstructure Section, with Stanley Block, Gaspar J. Piermarini, and Charles Weir attending. McMurdie asked the three if they thought that single-crystal x-ray diffraction studies were possible at high pressures now that the confinement of liquids in the diamond cell was possible with a metal gasket. Block replied that indeed they were possible if a pressure cell could be fabricated from beryllium metal, which is transparent to x radiation. As a result of that meeting, work on the development of the single-crystal high-pressure x-ray technique was initiated. In a tour de force of apparatus construction, Weir, in collaboration with Block and Piermarini, built one into an x-ray precession camera, thus permitting, for the first time, crystal structure determinations

<sup>169</sup> P. W. Bridgman, "The Resistance of 72 Elements, Alloys and Compounds to 100,000 kg/cm<sup>2</sup>," *Proceedings of the American Academy of Arts and Sciences* 81 (1952): 167-251.

<sup>170</sup> C. E. Weir, E. R. Lippincott, A. Van Valkenburg, and E. N. Bunting, "Infrared Studies in the 1- to 15-Micron Region to 30,000 Atmospheres," *Journal of Research of the National Bureau of Standards* 63A (1959): 55-62.

<sup>171</sup> A. Van Valkenburg, "High Pressure Microscopy" in *High Pressure Measurements*, eds. A. A. Giardini and E. C. Lloyd (Washington, D.C.: Butterworths, 1963): 87-94.

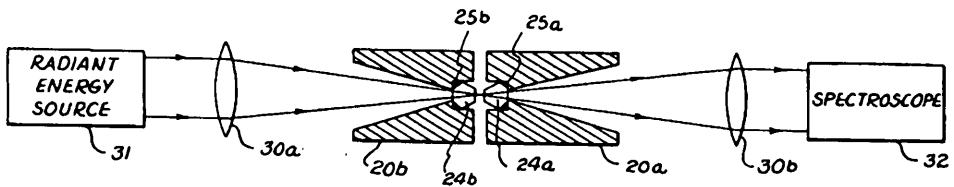
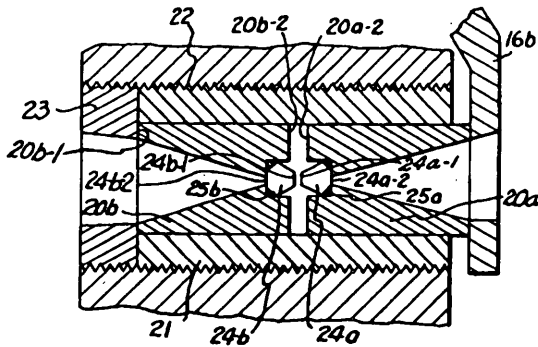
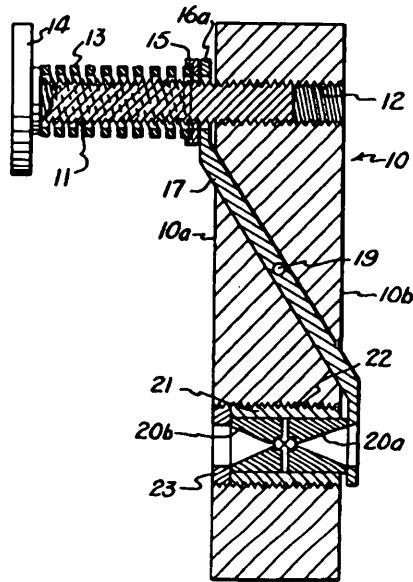

The high-pressure optical cell invented by Charles E. Weir, Alvin Van Valkenburg, and Ellis R. Lippincott, was utilized in the spectrum analysis of solid materials. The drawings above are from Patent No. 3,079,505. Top: cross-sectional view of the high-pressure cell. Middle: detailed cross-sectional view taken through the diamond holders in the lower portion of the cell. Bottom: System incorporating the cell.

of single crystals under high pressure.<sup>172</sup> The first single crystal structure determination was done on a high-pressure phase of benzene at room temperature.<sup>173</sup>

The diamond-anvil cell was a superb instrument, but it remained useful at that time primarily for qualitative observation since it lacked a means of pressure measurement. Various fixed points had been investigated, including solid/liquid transitions and shifts in the absorption band of nickel dimethylglyoxime, but their use was extremely cumbersome and subject to considerable error. Van Valkenberg left the Bureau in 1964. Block, Piermarini, and Weir continued further development of the diamond cell and used it in pioneering studies in anisotropic compressibility measurements on numerous explosive materials by single-crystal x-ray diffraction, phase diagram determinations of sulfur, zirconia, benzene, carbon tetrachloride, and other materials. Weir retired in 1970.

In 1968, John B. Wachtman became division chief and the division had become Inorganic Materials. He realized the need to find a better method for the calibration of the pressure in the diamond cell in line with the traditional mission of the Bureau. In an effort to solve this problem, Wachtman arranged a critical meeting with Stanley Block and John D. Barnett, then on leave from Brigham Young University, to discuss possible techniques to explore to solve this calibration problem. One of these was fluorescent spectroscopy which had not yet been tested. Shortly after that meeting, spectroscopist Richard A. Forman suggested testing several materials he had on the shelf in his laboratory. These materials included:  $\text{Al}_2\text{O}_3$  (0.5% Cr),  $\text{YAlO}_3$  (0.2% Cr), YAG (0.38%  $\text{Cr}_2\text{O}_3$ ), MgO (Cr) and others. In the tests it turned out that ruby was the best fluorescence material as a pressure sensor because it had the optimum characteristics for pressure shift, line sharpness, and line intensity. The idea was tried in a pressure cell in the laboratory with ruby dust excited by a filtered super-high-pressure mercury arc, and it worked. Using various materials with reasonably well-known transitions as fixed points, the shift in the wavelength of the radiation was found to be exactly proportional to the pressure.<sup>174</sup> Later, the shift in the ruby fluorescence line was calibrated against the compression of NaCl and linked to a pressure through its equation of state.<sup>175</sup> Finally, after more than a decade, a means of establishing the pressure in the diamond-anvil cell as accurately as the fixed points available was at hand.

<sup>172</sup> C. E. Weir, G. J. Piermarini, and S. Block, "Instrumentation for Single Crystal X-Ray Diffraction at High Pressures," *Review of Scientific Instrument* 40 (1969): 1133-1136.

<sup>173</sup> G. J. Piermarini, A. D. Mighell, C. E. Weir, and S. Block, "Crystal Structure of Benzene II at 25 Kilo-bars," *Science* 165 (1969): 1250-1255.

<sup>174</sup> R. A. Forman, G. J. Piermarini, J. D. Barnett, and S. Block, "Pressure Measurement Made by the Utilization of Ruby Sharp-Line Luminescence," *Science* 176 (1972): 284-285.

<sup>175</sup> G. J. Piermarini, S. Block, J. D. Barnett, and R. A. Forman, "Calibration of the Pressure Dependence of the  $R_1$  Ruby Fluorescence Line to 195 Kbar," *Journal of Applied Physics* 46 (1975): 2774-2780.

The new ruby technique was used initially to improve the pressure capability of the cell by noting the pressures at which distortions of the metal cell components caused anvil breakage. By correcting these deficiencies, Block and Piermarini were able to extend the pressure range of the diamond cell to 0.6 Mbar, the highest static pressure achieved and measured for that time and simultaneously revise the fixed-point pressure scale, lowering it by a factor of almost two. The generally accepted value of 50 GPa for the gallium phosphide (GaP) transition had to be lowered to 22 GPa as a result of their work.<sup>176</sup> At this point, they decided that this pressure range was sufficient for their purposes, leaving such scientists as geologists, interested in pressures at the center of the earth, to develop the cell for higher pressures. Block and Piermarini went on to develop pioneering applications and uses not only for the pressure cell, but also for the ruby pressure measurement technique.

For example, they, along with Barnett, used the physical characteristics of the ruby  $R_1$  lines to measure the onset of stresses in liquids by noting the pressure at which the lines broadened.<sup>177</sup> They used this technique to determine for the first time the hydrostatic limits in many liquids, i.e., the pressure at which a liquid no longer provides a hydrostatic pressure transmitting environment. These data were extremely valuable to the high pressure community. They also developed an elegant classical Stokes technique to measure the pressure dependence of viscosity of liquids and used a ruby sphere as the falling body in the liquid encapsulated in the diamond cell.<sup>178</sup> The ruby sphere also served as the pressure sensor. The viscosity data corroborated the ruby line-broadening results and was in agreement with the extrapolated glass transition pressure. The pressure cell was also designed for static heating to over 500 °C with a resistance coil furnace surrounding the anvil assembly. All of the above were pioneering developments at the NBS laboratory.

The ruby fluorescence pressure scale was subsequently extended by various scientists to 1 Mbar in 1978, and to 5.5 Mbar in observations in 1986. No longer was the diamond cell simply a qualitative or semi-quantitative instrument, but a serious quantitative research tool for carrying out studies—the quest for metallic hydrogen and the investigation of the state of matter at the center of the earth—not possible in any other way. It is not, in a general sense, a preparative device, although it has been used to synthesize tiny quantities of material and to determine the synthesis parameters for scale-up purposes. However, it is the instrument of choice as a research tool. Indeed, it is so ubiquitous and there are so many publications on its use, that its origins are all

---

<sup>176</sup> G. J. Piermarini and S. Block, "Ultrahigh Pressure Diamond-Anvil Cell and Several Semiconductor Phase Transition Pressures in Relation to the Fixed Point Pressure Scale," *Review of Scientific Instruments* 46 (1975): 973-979.

<sup>177</sup> G. J. Piermarini, S. Block, and J. D. Barnett, "Hydrostatic Limits in Liquids and Solids to 100 Kbar," *Journal of Applied Physics* 44 (1973): 5377-5382.

<sup>178</sup> G. J. Piermarini, R. A. Forman, and S. Block, "Viscosity Measurements in the Diamond Anvil Pressure Cell," *Review of Scientific Instruments* 49 (1978): 1061-1066; R. G. Munro, G. J. Piermarini, and S. Block, "Wall Effects in a Diamond Anvil Pressure-Cell Falling-Sphere Viscometer," *Journal of Applied Physics* 50 (1979): 3180-3184.



but forgotten. It was the result of the insight of scientists who were trying to do something that could not be done by the old, standard methods, and who had to stride off in completely different directions.

### Large Forces

In 1939 the Bureau received fewer than fifty force-measuring devices for calibration. By 1959 the number was more than 900 annually. Moreover, spurred primarily by the need to measure the thrust of rocket motors and the weight of rockets, there was an immense growth in the requests for calibrations of devices to measure very large forces, some as high as 3 million pounds. In 1962, Astin told the House Appropriations Committee, "One of the most urgent programs we have at the present time is one of extending our capability for making large force measurements. This is entirely brought about by the need for calibrating the devices which measure the forces on large rockets."<sup>179</sup>

Along with this was the necessity to obtain higher accuracy. In the previous year Astin had told the committee, "Recently, NBS was asked to calibrate a 1.5 million pound load cell for Rocketdyne's use on its contract with NASA to develop a 1-million-pound-thrust rocket motor. In August [the] Air Force . . . released the estimate . . . that an improvement in the accuracy of thrust measurements from the present three-fourths of 1 percent to one-fourth of 1 percent would save \$100 to \$150 million in the static test stages of current missile and rocket programs."<sup>180</sup>

Before continuing, we should make very clear the distinction between force measurement and mass measurement. Every undergraduate mechanics text points out that force is equal to the product of mass times acceleration, and that "weight" as commonly used in trade, refers to a force, not to a mass. In force calibrations, the usual equation is

$$F = K m g (1 - \alpha / \rho),$$

where

$F$  is force measured, for example, in newtons, dynes, pounds of force, or kilograms of force;

$m$  is mass in grams, kilograms, or pounds of mass;

$g$  is the acceleration due to gravity, measured in meters per second per second, centimeters per second per second, or feet per second per second;

$\alpha$  is the density of air; and

$\rho$  is the density of the mass used in the measurement.

If  $m$  is thought of as the apparent mass measured against brass standards in normal air, then the appropriate values for  $\alpha$  and  $\rho$  are 1.2 (kg/m<sup>3</sup>) and 8400 (kg/m<sup>3</sup>), respectively.

<sup>179</sup> House Committee on Appropriations, Subcommittee on General Government Matters, Department of Commerce, and Related Agencies, *General Government Matters, Department of Commerce, and Related Agencies Appropriations for 1962: Hearings Before a Subcommittee on Appropriations, House of Representatives*, National Bureau of Standards, 3 May 1961: 821.

<sup>180</sup> Appropriations Hearings for 1961: 285.

The quantity  $K$  in the equation is a constant whose value depends on the units used for the variables:

$K = 1$  if  $F$  (newtons),  $m$  (kg), and  $g$  ( $m/s^2$ );

$K = 1$  if  $F$  (dynes),  $m$  (g), and  $g$  ( $cm/s^2$ );

$K = 1/32.17405$  if  $F$  (pounds force),  $m$  (pounds mass), and  $g$  ( $ft/s^2$ );

$K = 1/980.665$  if  $F$  (pounds force),  $m$  (pounds mass), and  $g$  ( $cm/s^2$ ); and

$K = 1/9.80665$  if  $F$  (kg force),  $m$  (kg mass), and  $g$  ( $m/s^2$ ).

Thus the *weight* of a 1 kilogram *mass* on the moon, where the force of gravity is about one-sixth of its value on earth, would be  $\frac{1}{6}$  (kilogram force).

Calibration of such measuring devices as load cells or proving rings can be done quite accurately with dead weights, i.e., by hanging a known mass on the device and knowing the local gravitational acceleration and air buoyancy correction. In 1958 the Bureau had two dead-weight machines, one with a capacity of 111 000 pounds dating from 1927, and a smaller one with a capacity of 10 000 pounds. Force-measuring devices with capacities up to this level could be calibrated with an uncertainty of about 0.02 percent.<sup>181</sup> But in calibrating devices with higher capacities, several steps were required; combinations of proving rings or elastic devices had to be used, and accuracy was severely degraded in this process. Load cells up to 3 million pound capacity could be calibrated, but the accuracy was only 0.4 percent. Accuracies of 0.1 percent were necessary in measuring the thrust of large rocket motors.<sup>182</sup>

In 1958 the Bureau designed a 300 000 pound force dead-weight machine. Later, with the experience gained in this effort, the staff proceeded to design and build a 1 million pound force machine. The complement of machines was completed with a new 112 000 pound force dead-weight tester and several smaller ones. By 1964, the new machines were in operation in a special building at the Bureau's new Gaithersburg site, the first building constructed at the new site because of its urgency. They were joined by the venerable 111 000 pound force machine, which had been refurbished and brought out from the old site.

It is with the weights that accuracy begins, and they were impressive, to say the least. Thick discs of stainless steel, they weighed from 1000 to 50 000 pounds. The 1000 pound weights were 3 feet in diameter, while the heavier ones were 10 foot diameter giants. In each machine the weights could be hung incrementally from the device to be calibrated to provide a force range from zero to the full range of the machine. The machines themselves were not simple devices. Each consisted of a stack of weights, a loading frame holding the device to be calibrated at the top, and a lifting frame, actuated by a hydraulic jack, to lift the weights incrementally and thus

<sup>181</sup> Annual Report, 1960: 46-47.

<sup>182</sup> "Million-Pound Dead-Weight Machine Designed," *Technical News Bulletin* 43 (1959): 240.

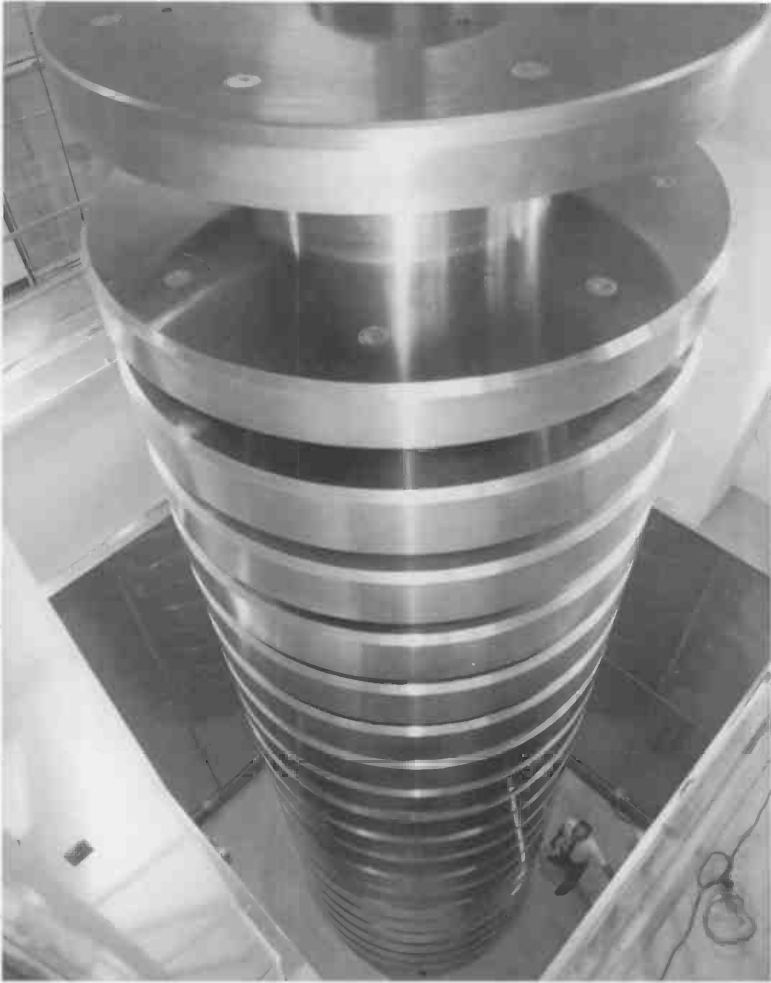

Deadweight stack of the 1 million pound force deadweight machine that was installed in the Engineering Mechanics Building, the first building completed at the NBS site in Gaithersburg (1963). Each 50 000 lb weight was 10 feet in diameter. Most of the stack sat below the first-floor level in a 26 foot deep pit. In this photograph, James I. Price adjusted the temperature control.

load them onto the device. The million-pound force machine had twenty 50 000 pound weights, and the other two had combinations of smaller weights. And the machines were large. The million-pound force giant was 96 feet tall, the 300 000 pound force machine was 62 feet, and the old 111 000 pound force machine was 54 feet. Access was available at various levels, and temperature in the whole assembly was controlled within  $\pm 0.5$  °C.

To obtain the applied force from the mass of the weights, which is directly traceable to the standard kilogram, knowledge of the value of the acceleration due to gravity, or



Arnold J. Mallinger calibrated a million-lb capacity proving ring in the 1-million-lbf capacity deadweight machine.

$g$ , at the location of the machines is necessary. To obtain this value, an absolute determination of the acceleration was made.<sup>183</sup> The value obtained,  $9.801018 \text{ m/s}^2$ , was used to adjust the force to a value of  $g$  of  $9.80665 \text{ m/s}^2$ , which was the value adopted in 1913 by the General Conference for Weights and Measures for the purpose of defining such units as pound-force and kilogram-force. Adjustments were also made for buoyancy caused by the atmosphere. When all was completed, the force applied by the dead-weight machines was accurate to 0.002 percent. It was an impressive performance.

The calibration of devices to measure forces greater than 1 million pounds force, as is necessary with very large rocket motors, is simple in principle. A number of force-measuring devices with 1 million pound capacity are first calibrated. Then, to calibrate

<sup>183</sup> D. R. Tate, "Absolute Value of  $g$  at the National Bureau of Standards," *Journal of Research of the National Bureau of Standards* 70C (1966): 149; "Acceleration Due to Gravity at the National Bureau of Standards," *Journal of Research of the National Bureau of Standards* 72C (1968): 1-20.

a larger capacity device with, say, a 5 million pound capacity, five of the calibrated 1 million pound devices are coupled together in parallel, so that each carries one-fifth of the applied load. This arrangement is placed in series with the high-capacity device to be calibrated and a force is impressed across the arrangement. The force applied to the unknown device is the sum of the forces on the calibrated devices, which are easily obtained from their output indicators. The output of the unknown device is noted, and the first point of the whole calibration curve is obtained. The procedure is repeated for other loads until the whole calibration curve is established. While the procedure is direct, accuracy is inevitably degraded for a variety of reasons.

The problem with this procedure is that it requires some kind of machine capable of supplying very large forces (5 million pounds force in the above example) and holding them steady while the necessary readings are taken. For this purpose, and because of its use in measuring the mechanical properties and strength of large structural elements, such as bridge columns and beams, the Bureau procured an immense testing machine. With the capability of supplying 12 million pounds force in compression, 6 million pounds force in tension, and 4 million pounds force to a flexural specimen, it was a true giant, 101 feet tall, with its lower 23 feet in a pit below ground level.<sup>184</sup> It was placed in a special 97 feet tall bay near its companion dead-weight machines, and in 1999 is still the Nation's largest universal testing machine.<sup>185</sup> Alongside its companion dead-weight machines, the whole formed a splendid new facility for the Bureau and the Nation.<sup>186</sup>

---

<sup>184</sup> Arthur F. Kirstein, *Universal Testing Machine of 12-million-lbf Capacity at the National Bureau of Standards*, Natl. Bur. Stand. (U.S.) Special Publication 355; September 1971.

<sup>185</sup> The story of how the decision was made to obtain the machine is interesting. The main purpose for the machine was the calibration of the large devices used in determining the thrust of rocket motors. Although the military—the main customers—were not certain what the highest thrust would be, a manufacturer of solid propellant motors was considering a 5 million pound thrust engine. But there was also considerable interest in the engineering community on large scale structural testing. Huge skyscrapers using immense beams were being considered. Norway was planning a testing frame with a 5 million pound capacity for ship structures, and Japan was building a 5 million pound machine for testing ships and the guy system for a planned inter-island suspension bridge. The largest capacity machine in the United States, located at Lehigh University, had a 5 million pound capacity. With these currents flowing, Astin ordered a study to give him a recommendation on the type of machine to be built. In due course a presentation was made to Astin by Lafayette K. Irwin, chief of the Engineering Mechanics Section of the Mechanics Division, accompanied by Bruce L. Wilson, chief of the division. Their recommendation was for a machine with a capacity between 10 million pounds and 20 million pounds in compression, but that it should not be a universal testing machine. The machine would be used for force calibration only, although a yoke could provide some testing capability as well. Such a machine need not be very tall, and would not be terribly expensive. Astin listened to the whole presentation silently, staring off into the distance, as was his custom. At the conclusion he turned to Irwin and Wilson and, stunning his audience, said, "The Bureau is going to have the largest testing machine in the world," and thus was made the decision to obtain the immense device. (Lafayette K. Irwin, private communication.)

<sup>186</sup> "New NBS Force-Calibration Facilities Capacity Increased to One Million Pounds," *Technical News Bulletin* 49 (1965): 186-188.

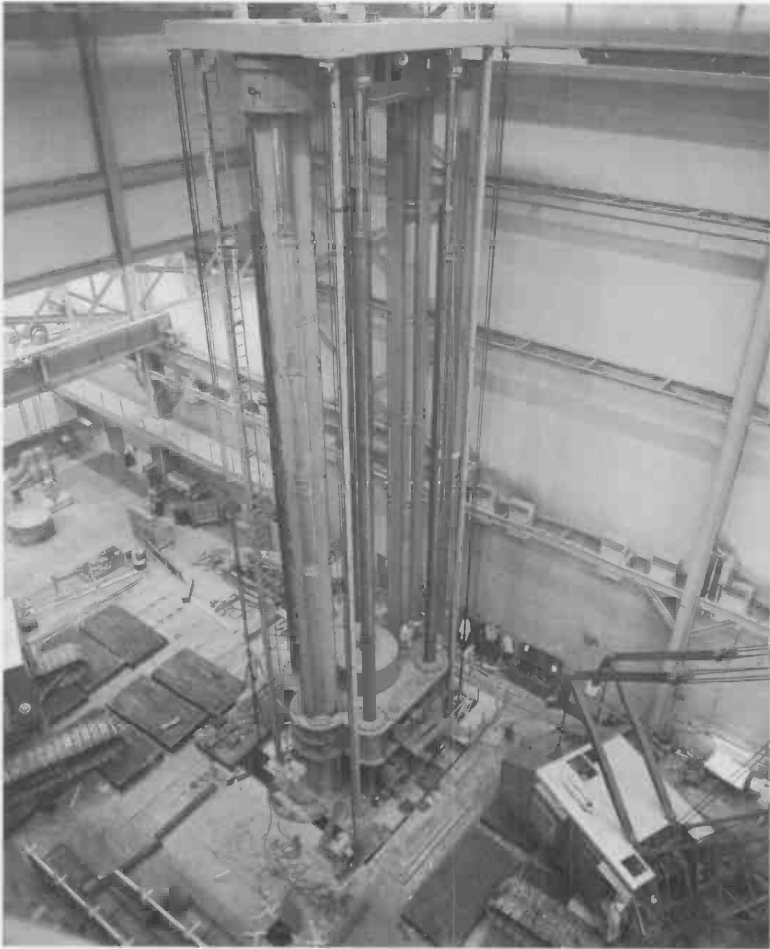

A 12 million lbf capacity hydraulic testing machine, believed to be the world's largest, was installed in the Engineering Mechanics Building. The machine provided the force to calibrate multi-million-lbf capacity force-measuring devices for space and industrial applications and to test full-scale structural components.

### **Time and Frequency**

Time is one of the fundamental quantities of the physical measurement system.<sup>187</sup> Thus the Bureau has always been concerned with time and frequency (essentially the reciprocal of repeated time interval) standards, and in this area carries out three functions: the development of frequency standards, from which clocks can be made

---

<sup>187</sup> More precisely, it is time interval and its unit, the second, that occur in the basic measurement system. Epochal time does not.

by direct (but not necessarily technically easy) counting; the definition of the unit of time—the second—and its relation to the standard of frequency; and the dissemination of time and frequency signals. During the period covered by this chapter, work in these areas produced a veritable cornucopia of results and added to the Bureau's capabilities and facilities.

### *Frequency Standards*

In 1949 the Bureau announced the first "atomic clock."<sup>188</sup> Really a "molecular clock," it was based on the microwave absorption line of ammonia. At that time the second was still defined on the basis of the rotation of the earth. The national standard of frequency, which served as the top of a chain for calibrating frequency measuring instruments, and controlled the frequency of the Bureau's two time and frequency broadcast stations—WWV in Beltsville, Maryland, and WWVH in Maui, Hawaii—was a set of quartz crystal oscillators rigorously maintained at a constant temperature in 50 feet deep wells. Their frequency was calibrated against the rotation of our slightly wobbly earth, a long, tedious process. The growth of science, the needs of modern navigation, the explosion in communications traffic, and military and space requirements, not to mention the sheer intellectual challenge involved, made the development of ever-more-accurate standards imperative, and the ammonia clock was the first attempt to build a timepiece based on a natural atomic constant.

While the idea of using an atomic oscillator as a frequency standard had been around for a long time,<sup>189</sup> recent advances in radio techniques and fundamental physics had made the construction of atomic clocks a real possibility.<sup>190</sup> The ammonia clock was based on the control of the frequency of a quartz crystal oscillator by the absorption of radiation by ammonia, which occurs very precisely at a frequency of 23.870 GHz. In the first model, the crystal oscillator was adjusted manually to keep its frequency at the value that would provide maximum absorption by the ammonia, which was contained in a 30 foot cell. Later, a feedback loop automatically adjusted the oscillator. In either case, the ammonia resonance controlled the frequency of the oscillator, and counting the cycles produced a clock. With a stability of 1 part in 20 million, it was no better keeper of time than the rotation of the earth, but it pointed the way to better instruments.

---

<sup>188</sup> Annual Report, 1949: 66-69.

<sup>189</sup> George K. Burgess, the second director of the Bureau, wrote in the *Standards Yearbook* in 1928, "Any radiation frequency emitted by an atom is the ticking of an atomic clock...." Snyder and Bragaw, *Achievement in Radio*: p. 292, cite Lord Kelvin as suggesting "the vibrational states of hydrogen and sodium atoms as natural standards of frequency and length (wavelength)."

<sup>190</sup> C. H. Townes, "Atomic Clocks and Frequency Stabilization on Microwave Spectral Lines," *Journal of Applied Physics* 22 (1951): 1365-1372. An analysis of the various types of possible atomic clocks, this paper was stimulated by Harold A. Lyons, then chief of the Bureau's Microwave Standards Section, under whose direction the ammonia clock was produced.

There was already a better candidate at the time the ammonia clock was announced. In 1945, I. I. Rabi of Columbia University had suggested that a magnetic resonance atomic beam technique could be used to produce a highly accurate atomic clock. In such a technique, the various line-broadening mechanisms, such as Doppler shift and pressure broadening, would be largely absent. This suggestion led to the proposal to use cesium beams where, in the absence of an external field, the interaction of the nuclear magnetic moment with the field at the nucleus produced by the spin of the valence electron splits the ground state of the atom into two states—the so-called hyperfine splitting. In one of the states, the electron spin is parallel to the nuclear moment; in the other it is antiparallel. The transition from one state to the other involves a very precise frequency. In an isolated atom, this is an invariant frequency, perfect for a standard. In the cesium beam device, a beam of atoms is produced by evaporation in an oven in which molten cesium is kept. A finely collimated beam is produced and passed through a short inhomogeneous magnetic field (a Stern-Gerlach magnet) which splits the beam into two, one in which all the atoms have their magnetic moment up, and one in which it is down. A slit selects one of the beams so that it passes into a long cavity in which it is subjected to a radio frequency (rf) field. From there it passes into another Stern-Gerlach magnet. If the frequency of the rf field is the same as the atomic moment reorientation frequency, then during the passage of the atoms through the cavity the magnetic moment of the atoms is flipped in orientation and the second Stern-Gerlach magnet directs them into a detector, which then produces a signal. If the frequency is not the same, most of the atoms are lost, and no signal comes from the detector. The result is an exceedingly sharp resonance curve with a center frequency equal to the reorientation frequency, a constant of nature approximately equal to 9.192 GHz for a cesium beam. As with the ammonia clock, the observed signal from the detector may be used with a servomechanism to control the frequency of the rf field, which is provided by a quartz oscillator with an appropriate frequency-multiplier chain.<sup>191</sup>

Research on the first NBS atomic beam clock, with help on the design by Polykarp Kusch, who had worked with Rabi, was begun in the same year as the announcement of the ammonia clock. Finished in 1952, it was labelled NBS I and had a stability of

---

<sup>191</sup> There is more to the matter than this simple explanation gives. First, in the cavity the atoms are not subjected only to an oscillating rf field. There is, in this region, a small uniform constant field “applied in order to preserve the state identity of the atom” while passing through the cavity (Beehler, Mockler, Richardson, “Cesium Beam Time and Frequency Standards,” 118). Since in the general case the reorientation frequency of the atomic moment is dependent on this constant field, a bad situation for a frequency standard would arise, for its accuracy would depend on an accurate knowledge of the strength and uniformity of this constant field. For this reason, the transition ( $F = 4, m_F = 0$ ) to ( $F = 3, m_F = 0$ ) is chosen for the standard since its frequency has only a second order dependence on the field, and this can be made negligibly small. Second, the atoms are not subjected to an oscillating field throughout the whole region of the cavity. Norman F. Ramsey showed that it was necessary only to subject the atoms to the oscillating field over a small region at the beginning and end of the cavity, provided only that the rf field in these two regions be accurately in phase. This technique also makes the resonance peaks narrower; makes their sharpness independent of non-uniformities in the constant field; and is more convenient to use. (N. F. Ramsey, “A Molecular Beam Resonance Method with Separated Oscillating Fields,” *Physical Review* 78 (1950): 695-699). Professor Ramsey shared the 1989 Nobel Prize for his discovery.



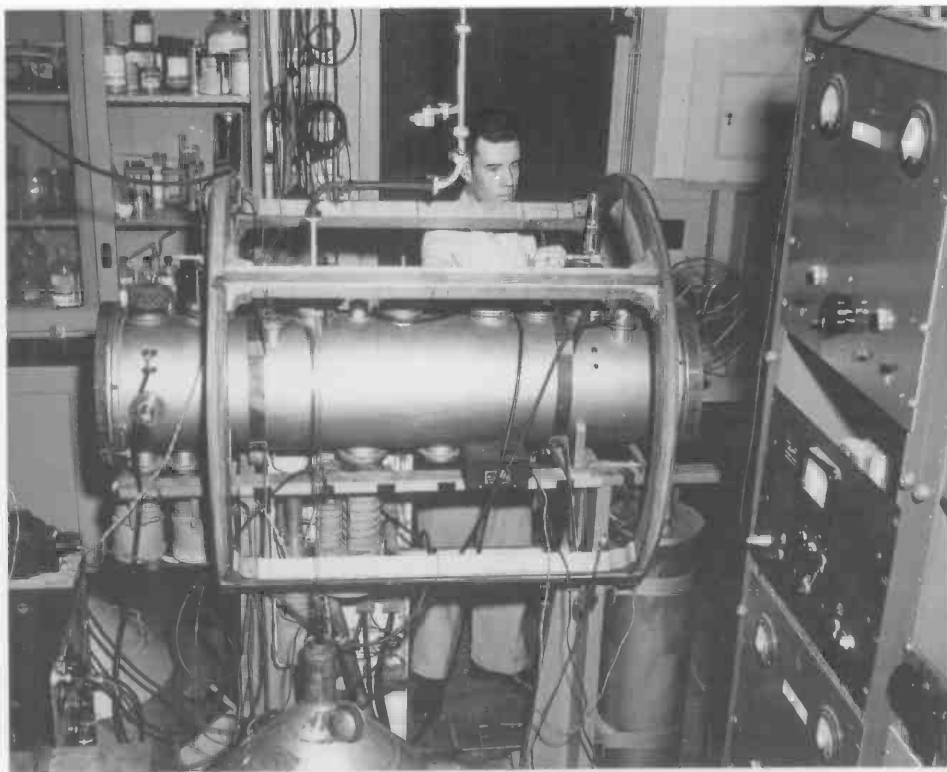

The clock known as NBS I, fully operational by 1952, used a beam of cesium atoms to control electronic and microwave circuits to better than 1 part in 100 million. A conventional electric clock connected to the atomic clock would vary no more than one second in three hundred years.

1 part in  $10^{10}$  and, after modification, it attained a relative uncertainty of 2 parts in  $10^{10}$ . Built in the Bureau's Washington laboratories, it was disassembled in 1954 and shipped to the Bureau's new site in Boulder, where it was reassembled. A relatively primitive instrument, it had no servomechanism, and the frequency of the driving quartz oscillators had to be adjusted manually, as was necessary with the ammonia clock. This feature made its use as a frequency standard or clock impractical.

Construction began on another cesium beam clock that same year. With a longer cavity,<sup>192</sup> and with servomechanism control, this was expected to be a far more advanced clock. It was completed in 1958 and compared with NBS I, which had been rebuilt and had attained "a precision of 2 parts in  $10^{10}$ ."<sup>193</sup> A careful evaluation of the two clocks "enabled the United States frequency standard to be referred to in terms of atomic resonance with an accuracy of 1.5 parts in  $10^{11}$ ."<sup>194</sup> On January 1, 1960, NBS II

<sup>192</sup> The longer the cavity, the sharper the resonance. Townes, "Atomic Clocks," 1371-1372.

<sup>193</sup> Annual Report, 1959: 123.

<sup>194</sup> Annual Report, 1960: 38; R. E. Beehler, R. C. Mockler, C. S. Snider, "A Comparison of Atomic Beam Frequency Standards," *Nature* 187 (1960): 681-682.

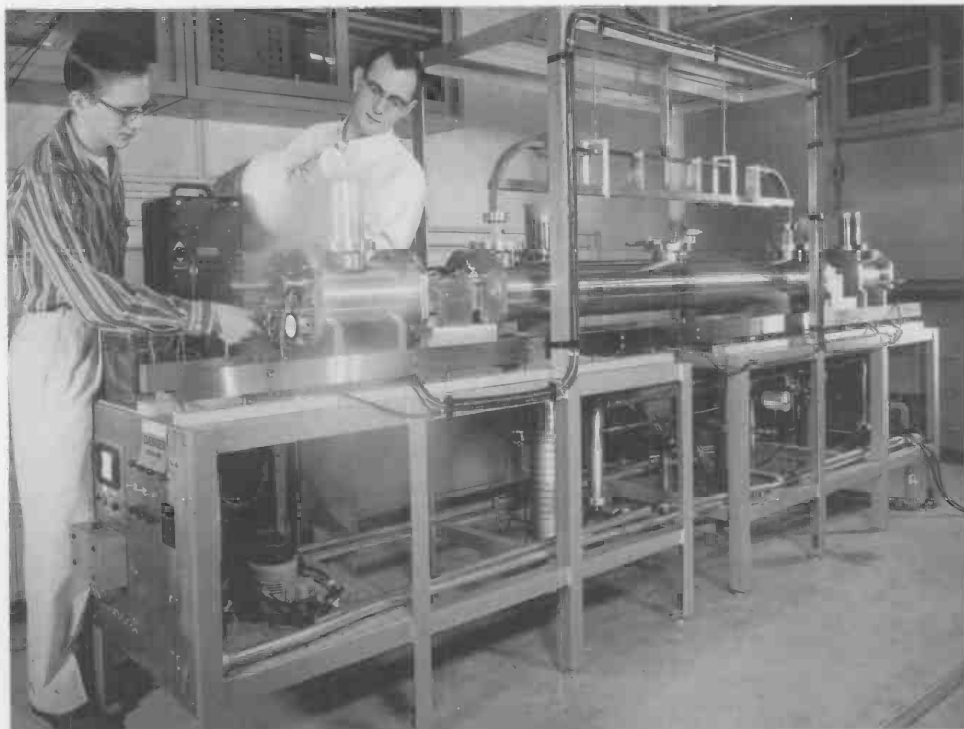

NBS II measured frequency and time intervals to an accuracy equivalent to the loss of one second in three thousand years. In 1960, it became the National Frequency Standard. As shown in this photograph, Roger Beehler adjusted the atomic beam detector while Charles Snider poured liquid nitrogen into a cold trap at one end of the instrument. The nitrogen helped to form a vacuum so that cesium atoms could be beamed through the machine without being deflected by molecules of air.

became the national standard of frequency, supplanting the quartz oscillators in their cool wells. From that day to this, the frequency of a cesium clock has been the frequency standard of the United States.

In 1959, before NBS II became the national standard of frequency, construction was begun on NBS III. It was finished in 1963, whereupon it was designated as the national standard. It had a resonant cavity 366 cm long—twice the length of NBS II. It served until 1969, at which time it had achieved a stability of 1 part in  $10^{13}$ , and a relative uncertainty of 5 parts in  $10^{13}$ . Another clock, NBS-4, a short 50 cm cavity clock built to test new ideas for improving the stability of cesium clocks, took over from NBS III in 1969. It was extremely stable, achieving a stability of  $7 \times 10^{-15}$ . To complete the roster, NBS-5 was completed in 1972 and served until 1974, when the next model, NBS-6, took over with a relative uncertainty of 9 parts in  $10^{14}$ , or 1 second in 300 000 years. NIST-7 officially replaced NBS-6 in January 1993. It was put into service with a relative uncertainty of  $4 \times 10^{-14}$  that was later improved to  $5 \times 10^{-15}$ .

Atomic clocks spawned a new industry. Small, portable cesium-beam and rubidium-beam clocks are made commercially and sold to organizations that require high-precision clocks, such as broadcasters, the military, and telephone systems. The National Institute of Standards and Technology uses them as well.

To leave the matter here would not do justice to all the effort in time and frequency. Many other paths had been travelled before selecting the cesium clock as the national standard. The original ammonia clock had been highly developed and supplanted by the much more precise ammonia maser.<sup>195</sup> In turn the ammonia maser was followed by the hydrogen maser, still under investigation at the end of the period. A hydrogen cyanide maser had been tried. Oxygen had been explored as a replacement for ammonia in an absorption-controlled clock. Thallium-beam and rubidium optical-microwave double resonances had been investigated, but had not supplanted the cesium clock. Quartz crystals at the temperature of liquid helium had been studied. But the cesium beam clock became the standard, in large part because it was extensively investigated internationally, hence was best understood.

### *The Definition of the Second*

Since the unit of time is the second—one of the basic units for quantified characterization of physical standards—NIST has the central responsibility in the United States for its definition. To carry out this obligation, NIST serves as the Nation's representative to the international bodies—the International Committee for Weights and Measures (CIPM) and the General Conference for Weights and Measures (CGPM)—that promulgate this definition. When the second is compared to units of other quantities, however, it has a unique peculiarity. Like the krypton-86 unit of length, it is not a unit that can be stored in a vault and periodically pulled out for calibration purposes; it must be generated. In either case, of course, the apparatus may be stored in a vault—at least conceptually. But the second, or time, has a further peculiarity. If a clock is to be built from a frequency apparatus that generates seconds by counting repeated events, then the apparatus must operate continuously, for time constantly passes even when the clock is stopped. Without this requirement for continuity of operation, a frequency apparatus is useful for the generation of time interval, but not for time nor, its more formal description, epoch.<sup>196</sup>

Before the advent of atomic clocks, the definition of the second was an astronomical matter, for the second was defined on the basis of the motion of the earth with respect to other astronomical bodies. This provided a good definition of the second and had complete continuity. The earth was a good clock but its use was cumbersome for determining time interval. Thus, in those days the function of the Bureau was primarily as custodian of the national standard of frequency with the assurance that this standard was in accord with the astronomical definition of the second.

<sup>195</sup> Gordon, Zeiger, and Townes, "The Maser," 1264-1274.

<sup>196</sup> The word epoch is used rather than the word time, because time in its common usage can refer either to a time/date point along some timekeeping continuum or to a time interval. Epoch can only be interpreted as the time/date point (the reading and logging of the day, date, hour, and minute), and is difficult to confuse with time interval. (Donald B. Sullivan, private communication)

Before 1956 the second was defined as  $1/86400$  of a mean solar day. This definition was not adequate since its basis, the mean solar day, was subject to temporal variations in the rotation of the earth. Nevertheless, it was the basis for various time scales which denoted Universal Time, or UT. In an attempt to remedy the non-constant nature of the second as thus defined, a new definition based on the more constant yearly revolution of the earth, was adopted in 1956.<sup>197</sup> Called the ephemeris second, this new unit was based on an invariant occurrence, but this did not make its realization any easier. Even as the new unit was adopted, it was clear that its realization was not as accurate as the second generated by atomic-frequency devices, although by its definition it was a constant unit of time.

In a three-year cooperation between the National Physical Laboratory and the U.S. Naval Observatory, the frequency of a cesium frequency generator was determined in terms of the ephemeris second with the finding that the cesium frequency was  $9\,192\,631\,770 \pm 20$  Hz, with most of the uncertainty coming from the astronomical observations.<sup>198</sup> By 1964, national laboratories were achieving relative uncertainties of about 1 part in  $10^{11}$  with their cesium-beam devices, and the Twelfth General Conference for Weights and Measures authorized the CIPM to designate an atomic or molecular frequency to be used temporarily for the physical measurement of time. The International Committee declared the cesium-133 frequency to be  $9\,192\,631\,770$  Hz. The Bureau had adopted this frequency on January 1, 1960.<sup>199</sup> The final step in the shift from an astronomical to an atomic definition of the second was taken in 1967 when the 13th CGPM adopted the unit of time as the second, defined as the duration of  $9\,192\,631\,770$  periods of a well-defined resonance in the cesium-133 atom.<sup>200</sup> All previous definitions were abrogated.

The various national laboratories did not wait for this formal action to construct atomic clocks and time scales. Even before the adoption of the value of the cesium frequency by the CIPM, it was clear what the choice would be, and various time scales were developed.<sup>201</sup> All that was necessary was a starting point to define the epoch and an arrangement to ensure that the system operated continuously. The most direct way to make a clock to generate a time scale would be to divide down the frequency of the quartz oscillator that is locked to the cesium frequency standard, and drive a mechanical or electronic clock directly. But that would require that the cesium standard work continuously, and this is unrealistic. In fact, in the Bureau system during the period, a free-running quartz oscillator drove the clock. Every day the frequency of the oscillator was calibrated in terms of the National Frequency Standard and, assuming that any observed difference was caused by a linear drift, corrections were made to the time as

<sup>197</sup> *Onzième Conférence Général des Poids et Mesures* (Paris: Gauthier-Villars, 1960): 15-16.

<sup>198</sup> W. Markowitz, R. G. Hall, L. Essen, and J. V. L. Parry, "Frequency of Cesium in Terms of Ephemeris Time," *Physical Review Letters* 1 (1958): 105-107.

<sup>199</sup> Annual Report, 1960: 38.

<sup>200</sup> The official, more-precise definition of the second is given in Barry N. Taylor, *The International System of Units*, Natl. Inst. Stand. Technol. (U.S.) Special Publication 330; August 1991: 29.

<sup>201</sup> R. E. Beehler, R. C. Mockler, and J. M. Richardson, "Cesium Beam Atomic Time and Frequency Standards," *Metrologia* 1 (1965): 127-128.

kept by the quartz clock. This provided a time scale called NBS-A. Its epoch was set to be "approximately equal to that of UT2 at 0h0m0s on 1 January, 1958." Other time scales based on the cesium standard were also developed, differing mainly in epoch and calibration scheme. The Naval Observatory developed a similar scale, called A<sub>1</sub>, based on the weighted average of nine laboratory and commercial cesium standards throughout the world. The Swiss TA<sub>1</sub> scale, also set to coincide with Ephemeris Time at 0h0m0s on January 1, 1958, was based on the cesium standard at the Laboratoire Suisse de Recherches Horologeres (LSRH).

Astronomical time was, however, important for navigation and astronomical purposes, so it was important to reconcile any differences that might arise between time kept by the various atomic time scales and that kept by the earth, with its relatively erratic motion. As a result various corrections were made periodically to the atomic scales to keep them consistent with the "earth clock." Adjustments were made either in the broadcast frequency or in the phase of time signals. A typical adjustment of the latter kind reads,<sup>202</sup>

An adjustment in the transmission of time signals has been announced jointly by the U.S. Naval Observatory and the National Bureau of Standards. . . . The transmitting clocks at the radio stations were retarded 100 milliseconds 1 November 1963 at zero hours Universal Time (7 p.m. EST of 31 October).

The adjustment becomes necessary because of changes in speed of rotation of the earth, as determined by astronomical observation. Such adjustments are made by international agreement, according to a plan whereby the times of emission of time signals are synchronized to about 1 millisecond. The last previous adjustment in phase of time signal pulses was made 1 August 1961.

The countries participating in the coordination of time signal transmissions are Argentina, Australia, Canada, Italy, Japan, South Africa, Switzerland, the United Kingdom, and the United States.

In later years "leap seconds" would be either inserted or removed from the time scale to maintain consistency.

### ***Frequency and Time Dissemination***

The Bureau began its radio dissemination of standard frequencies in 1923 with broadcasts from its Van Ness site via radio station WWV, which it operated for this purpose.<sup>203</sup> Throughout its history, improvements were continually made to this service: in the accuracy of the signals, in the number of frequencies broadcast, by the broadcast of 1 second time pulses, by the broadcast of time in cooperation with the Naval Observatory, and by the broadcast of 1000 Hz and 440 Hz (musical A) signals.

<sup>202</sup> "Adjustment in Phase of Time Signals," *Technical News Bulletin* 47 (1963): 219.

<sup>203</sup> Snyder and Bragaw, *Achievement in Radio*: 260-288, give a complete and detailed chronology of the Bureau's time and frequency dissemination activities via radio transmission.

In 1931, the transmitter was moved to College Park, Maryland, for a brief one year stay, and then to the Agricultural Research Station of the USDA in Beltsville, Maryland. The location name of WWV was changed to Greenbelt, Maryland, in 1961. The frequencies were always controlled by the national standard of frequency (later called the USFS). In 1948 another station, WWVH, was established on the island of Maui in Hawaii, to better serve the Pacific Ocean area. In 1957 WWV broadcast at 2.5 MHz, 5 MHz, 10 MHz, 15 MHz, 20 MHz and 25 MHz, and WWVH at 5 MHz, 10 MHz, and 15 Mhz. The broadcasts covered the United States and the Pacific Ocean, and were widely received throughout the world.

While the frequency of the carrier wave as broadcast—controlled as it was by the national standard of frequency—was as accurate as possible, the frequency of the received signal was far different. Studies carried out in Boulder in the early fifties showed that the frequency of the received signal was subject to change, leading at times to a relative uncertainty as great as  $\pm 3$  parts in  $10^7$ , while the relative uncertainty of the transmitted signal was approximately 1 part in  $10^9$ . It happens that the relatively high frequency waves broadcast—so called “sky waves”—are propagated by reflection from the ionosphere, which is a variable, movable mirror subject to solar and other disturbances. This causes Doppler shifts and other interferences which degrade the signal and reduce its accuracy. Comparisons of a given frequency with this varying signal can be made more accurate by time averaging over one to ten days, but this was too long for many calibration and research purposes.

It was thought that the best way to solve this problem was to broadcast via a ground wave which would travel within the duct formed by the ionosphere and the earth's surface, rather than relying on reflection from the ionosphere for propagation. Such a signal would not be subject to error-producing reflections. It was well known that such propagation occurred at low transmission frequencies. Indeed it had been shown by John A. Pierce of Harvard that, for frequencies below 100 kHz and for distances up to 5000 km, it took only about ten minutes to compare local frequencies with the broadcast standard to 1 part in  $10^9$ . As a result, William D. George, acting chief of the Radio Standards Laboratory, began experimental low-power broadcasts from Boulder at 60 kHz, using the call letters KK2XEI (later WWVB). By June 1956, with the help of Pierce, the Bureau broadcasts were compared with British low frequency transmission at 60 kHz and 16 kHz to better than 1 part in  $10^9$ , a lower uncertainty than could be obtained by comparison with the high-frequency broadcasts with ten-day averaging.<sup>204</sup>

The 60 kHz broadcasts were designed to cover the forty-eight contiguous states. To serve a greater area, and possibly the whole world, required even lower frequencies, and in 1958 experiments were begun on broadcasts at 20 kHz. To provide such broadcasts required international cooperation, for radio waves do not respect national boundaries. In April 1959, acting on a Bureau recommendation, the U.S. group of the International Radio Consultative Committee (CCIR) adopted 20 kHz as the most efficient frequency for the transmission of standard frequency on a global scale. In December 1959, this frequency was also adopted by the International Radio Conference. Finally,

---

<sup>204</sup> “Experimental Standard Frequency Broadcast on 60 Kilocycles,” *Technical News Bulletin* 41 (1957): 99-100.

in January 1960, the U.S. Government's Interdepartmental Radio Advisory Committee (IRAC) approved a Bureau application to operate a 20 kHz standard frequency broadcast. By international agreement on such requests, the Bureau had ninety days to get on the air.<sup>205</sup>

The price of transmitting low frequencies is antennas. At 20 kHz the wavelength is 15 km, and antennas have to be immense if they are to efficiently broadcast this frequency. Fortunately, in Four-Mile Canyon near Sunset, Colorado, the Bureau had an existing antenna, previously used for low-frequency ionospheric research and other purposes. This was modified for the 20 kHz broadcasts. It was an impressive array. A copper-coated steel cable stretched 3400 feet between two peaks 900 feet above the canyon floor. A feed line from its center dropped down to the 20 kW transmitter; the call letters were WWVL. Transmission began in the spring of 1960, and it was gratifying that the signal was received at least as far away as New Zealand.

It had always been planned that neither the WWVB site in Boulder nor the WWVL site near Sunset would be permanent; they were for experimental purposes. The permanent site would be on a carefully chosen 380 acre tract near Fort Collins, Colorado,

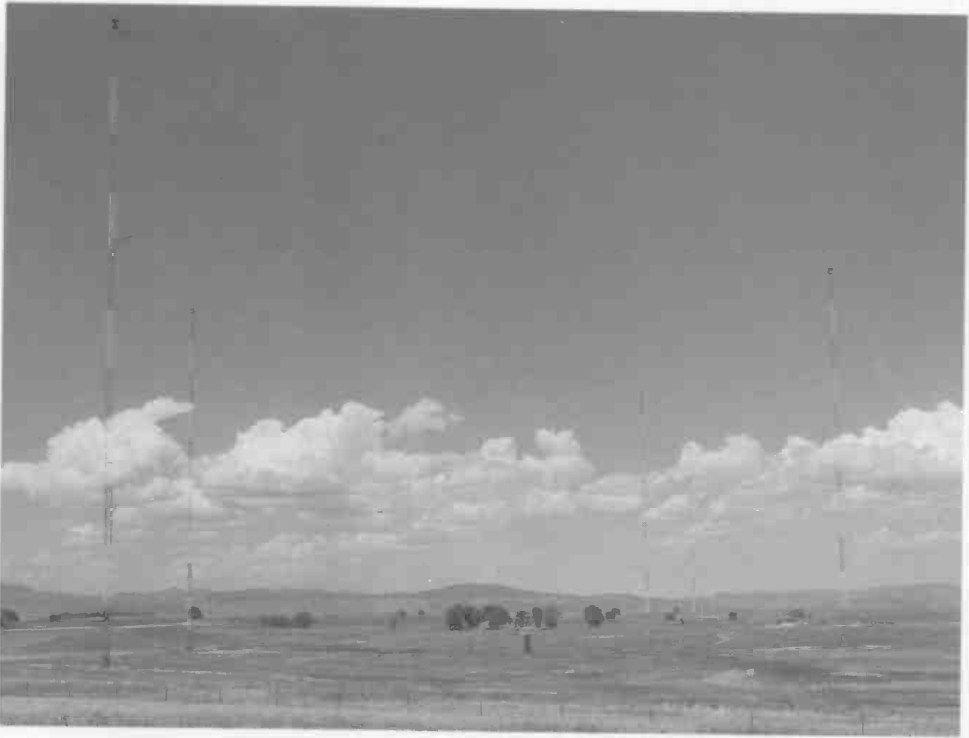

Facilities near Fort Collins, Colorado, for stations WWVL and WWVB. The antenna for each station consisted of four steel towers arranged in a diamond 1900 feet long and 750 feet wide.

<sup>205</sup> "New Standard Frequency Broadcasts," *Technical News Bulletin* 44 (1960): 120-122.

some fifty miles north of Boulder. The primary assets of the new site were high soil conductivity, the availability of electric power, relative freedom from both weather extremes and man-made noise, and ease of access. Here 50 kW transmitters and more efficient antennas would greatly increase the radiated power, which for WWVL would jump from 15 W to 1 kW, and for WWVB from 1 kW to 5 kW. A fifty mile cable would provide a direct connection, hence frequency control of the transmitters with the national standard of frequency at Boulder. When WWVB began broadcasting on July 5, 1963, and WWVL in August of the same year, the relocation of the Bureau's low-frequency transmitters was complete. The Bureau had a new facility for expanding a service it had historically provided.<sup>206</sup>

## Calibrations

The late fifties were a time of ever-increasing demand for calibration services. Spurred by the needs of the electrical industry and the military services, the demands did not lessen with the turn of the decade. In 1960 the Annual Report states: "The demand for improved calibration services based on new or more accurate measurement standards continued to grow during the year. Calibration needs were most evident in electronics, but requests for greater accuracy and wider range of measurement were received in virtually all fields of measurement."<sup>207</sup> By that time the Bureau was limiting itself insofar as possible to the calibration of reference standards for other standards laboratories, which then calibrated working standards and, finally, the instruments of industry, science, and the military. "To an increasing extent, the Bureau was called upon for assistance to the other standards laboratories that have been set up," states the Annual Report for 1959.<sup>208</sup>

The need for a wider range of calibration services was well documented. In 1959 the Aerospace Industries Association queried seventy member companies in its field and found increased needs in microwave, temperature, vibration, and shock measurements. More than one hundred of the needs were for services not already provided by the Bureau. "Either the Bureau did not provide any service for the particular physical quantity involved, or the range of measurement or accuracy required was not available." More basic research was needed.<sup>209</sup>

In no field were these demands for services stronger than in radio standards. In response to this need, the Bureau began the construction of an Electronic Calibration Center on the Boulder site in 1956 with support from the military services. Built particularly to provide services to the military standards laboratories, it began operation in 1958, and FY 1959 was its first full year of operation. This new facility permitted an explosion in the number of calibrations of radio-related equipment. Thus, 508 items of radio equipment were calibrated in 1958. The number jumped dramatically in 1959 to

---

<sup>206</sup> "Frequency and Time Transmission: New LF and VLF Antennas and Transmitters Under Construction," *Technical News Bulletin* 46 (1962): 185-186.

<sup>207</sup> Annual Report, 1960: 15.

<sup>208</sup> Annual Report, 1959: 7.

<sup>209</sup> Annual Report, 1961: 9.





The Electronic Calibration Center, a new wing of the NBS Boulder Laboratories, was completed in 1958. Its 27 000 square feet of floor space accommodated \$2 million worth of equipment for calibration service to the electronics industry and the military.

8594. Through 1964 calibrations averaged 3600 radio instruments per year. In the other divisions demand held steady, totalling about 75 000 calibrations yearly. Yet despite this disparity in the number of items, the total fee value of the two groups of items was about the same, averaging \$969 000 for radio standards and \$1.05 million for all other types. Clearly, the value per item was much higher for the complex radio equipment, being of the order of \$275 per item as contrasted with about \$15 per item in other calibrations. And business boomed, increasing from a total of \$1.58 million in 1960 to \$2.36 million in 1964, an increase that was more than twice the rate of inflation.<sup>210</sup>

The Bureau took several actions to improve the Nation's calibration system. In 1960 two new advisory committees were formed, one on Engineering and Related Standards, and the other on Calibration and Measurement Services. Unlike the other advisory committees, which served individual organizational units, these were concerned with the Bureau's entire operation in their assigned fields. Then, as part of its effort to divest itself of routine calibrations and limit itself to the calibration of reference standards for commercial, private, and military standards laboratories, NBS formed and sponsored the National Conference of Standards Laboratories. The brainchild of Harvey W. Lance, head of the Electronic Calibration Center, this organization provided

<sup>210</sup> Annual Reports: 1958: 100; 1959: 9; 1960: 16; 1961: 11; 1962: 14; 1963: 3; 1964: 6.

a means by which standards laboratories could cooperate and share information on calibration techniques and the operation of standards laboratories. The first meeting of this new institution was held at the Boulder site in 1962. For three days, 600 persons discussed technical and administrative matters of importance to standards laboratories. A record of the proceedings was published.<sup>211</sup> Yearly conferences became the norm.<sup>212</sup>

Other, more specialized conferences were held, particularly in the radio field, and new specialized publications were issued, culminating in 1962 in the massive three-volume Handbook 77, *Precision Measurement and Calibration*.<sup>213</sup> A special column in the monthly *Technical News Bulletin* was initiated in the same year. In 1963 the Bureau also began publishing the schedule of services and fees for calibrations that had been published for many years in the *Federal Register*.<sup>214</sup> The catalog was initially issued in sections prepared by the various NIST calibration services, but is now a single volume and has replaced the notices in the *Federal Register*.

### Standard Samples Become Standard Reference Materials

The history of standard samples during the period generally mirrored that of calibration services. Starting with a large jump in sales of items from 38 800 in 1957 to 70 500 in 1959, sales leveled off between 66 000 and 81 000 items annually. But, as with calibrations, the value of sales increased, rising from \$188 200 in 1957 to \$573 600 in 1964—a factor of three, and far greater than the rate of inflation—attesting to the increasing sophistication of the items.<sup>215</sup> New samples were added periodically and old ones retired as their utility and need decreased. Thus, in 1957 580 samples were for sale, while in 1964 more than 600 were available. But more illustrative is the change in kinds of available samples. In 1957 a wide range of pure hydrocarbons and organic sulfur compounds of interest in automotive fuels research were available. All had been discontinued by 1964 following the demise of the Bureau's automotive research program. To the venerable steel-composition standards, which had been the first of the Bureau's standard samples, dating back to 1905, zirconium-based alloys had been added because of their utility in nuclear power development, and titanium alloys had been added due to aerospace concerns. In

---

<sup>211</sup> *Proceedings of the 1962 Standards Laboratory Conference*, Natl. Bur. Stand. (U.S.) Miscellaneous Publication 248; August 1963.

<sup>212</sup> In 1985, this eminently successful organization became independent, operating without Bureau sponsorship but maintaining close liaison with it. By that time it had expanded to include foreign members, and over 900 organizations belonged. Its scope had grown to include all areas of measurement.

<sup>213</sup> *Precision Measurement and Calibration*, Volumes I-III, Natl. Bur. Stand. (U.S.) Handbook 77; February 1961. This handbook was expanded in the late 1960s and early 1970s to a 10 volume set, Special Publication 300, of the same name.

<sup>214</sup> *Calibration and Test Services of the National Bureau of Standards*, Natl. Bur. Stand. (U.S.) Miscellaneous Publication 250; December 1970.

<sup>215</sup> The cost of the background research on which standard samples were based could not be charged to the customer. Only the costs of preparation and handling were permitted.

radioactivity standards, new nuclides were offered, among them americium-241, promethium-147, cobalt-60, a series of point source gamma ray standards, and, of course, maintaining carbon-14 samples for standardization of radio carbon dating. All but three of twelve rock samples certified for radium content were removed. The changes reflected a moving snapshot of the development of nuclear technology.

In symmetry with the National Standard Reference Data System, standard samples, which had been variously labeled as standard samples, standard materials, and reference materials, were finally labeled Standard Reference Materials (SRMs) in 1963. At the same time, an Office of Standard Reference Materials was formed under Wayne Meinke, new chief of the Chemistry Division. This office had the responsibility of administering the production and sale of SRMs along with the function of working with the outside scientific and industrial community to plan the future directions of the activity and the development of new SRMs. With this move the Bureau's SRM program was organized and stabilized.

### **The End of Product Testing**

In an agreement with the General Services Administration (GSA), the Bureau, as a result of the AD-X2 affair and the resulting report of the first Kelly Committee, clarified its position with respect to routine testing of Government purchases. Under that agreement, it limited itself to the preparation of general test methods and specifications for products where it had specific knowledge and interest, to areas where it had unique capabilities, and routine testing in areas where it had developed specifications. Even with these qualifications, while showing a decrease during the period, testing remained a significant activity, averaging 54 400 samples tested per year at an average total fee value of \$1.2 million. As was historically the case, cement testing accounted for approximately 70 percent of this activity. In addition, a few new specifications were prepared annually, giving the Bureau custody of approximately 200 such standards, and for other agencies it reviewed on the order of several hundred specifications per year to determine their suitability as Government standards. There was even an administrative change. Cement testing, historically in the Mineral Products Division, was taken over by the Building Technology Division in 1960.

With the move to Gaithersburg coming ever closer, a more permanent resolution of the Bureau's position in acceptance testing had to be achieved. In 1965, Astin wrote to J. Herbert Hollomon:

The . . . Bureau . . . expects to maintain a facility for the actual testing of items purchased by the General Services Administration and other agencies of the Federal Government. This will be operated by the Bureau with the understanding that the GSA, which will pay for the facility, will take over its operation by the end of 1969.<sup>216</sup>

---

<sup>216</sup> Memorandum, A. V. Astin to J. H. Hollomon, "Engineering and Commodity Standards Activities," May 3, 1965. (DOC; Assistant Secretary for Science and Technology; Accession 40-70A-6988; Box 27; Folder NBS-Commodity Standards)

Thus, in 1966, an organizational unit first called the NBS-GSA Laboratory and later the NBS/GSA Test Development Division was formed and headed by Philip J. Franklin. As promised, the unit was transferred to the GSA in 1969. "The transfer of the laboratory is appropriate," read the Annual Report, "since GSA has responsibility for qualified product lists and has the legislative authority to run a laboratory for testing products against standards."<sup>217</sup> Started in 1903 with the testing of light bulbs, this program, which had indirectly caused the major furor of the AD-X2 affair, quietly left the Bureau in 1969 with only a few members of the staff aware of its demise. Its departure was a testament to the changing nature of the Bureau.

### **Commodity Standards and a Reversal of Position**

On December 17, 1962, Allen Astin, responding to a request from Assistant Secretary Hollomon, gave his views on the Bureau's role in engineering and commodity standards.<sup>218</sup> By "engineering standards" Astin meant "codes, specifications, and standards of quality or performance pertaining to technological materials or devices. A brief background review is desirable since my recommendations involve a reversal of recent trends." Astin pointed out that, spurred by then-Secretary of Commerce Herbert Hoover, the Bureau's involvement in such standards reached a peak in the mid-twenties. However, with the emergence of the American Standards Association (now the American National Standards Institute (ANSI)) in 1928, and a "firming-up of the concept that the development of engineering standards should be left primarily to private initiative," the Bureau's activities began to decline.<sup>219</sup> In the postwar period, a report by a committee headed by Charles E. Wilson, president of General Electric, recommended that the Government look to the private sector for engineering and commodity standards, and that the Bureau devote itself to data taking and test method development. In 1949, the GSA was created and given statutory responsibility for specifications and product evaluation for Federal purchases. The Bureau was put into a position of providing cooperation, not leadership. Its non-technical work, which was principally in providing procedures and a secretariat within which industry could develop standards (the same type of services provided by ASA and ASTM), was transferred to the DOC's Office of Science and Technology in 1950. The Bureau was no longer in charge of developing commodity standards.

But things did not work out well in this new arrangement. Many desirable standards had not been developed; ASA had trouble getting support from its member institutions; and U.S. participation in international standards activities was weak. The commodity standards work of the DOC declined in both quality and quantity.

<sup>217</sup> Annual Report, 1969: 3-4.

<sup>218</sup> Memorandum, A. V. Astin to J. H. Hollomon, "Engineering Standards," December 6, 1962. (NIST RHA; Director's Office file; Box 381; Folder Chrono 1962); Memorandum, J. H. Hollomon to A. V. Astin, "National Bureau of Standards and Commercial Standards," October 17, 1962. (DOC; Assistant Secretary for Science and Technology; Accession 40-70A-6988; Box 11; Folder October 1962)

<sup>219</sup> See MFP, 258, 260n, 370, 450 for a good history of these developments. An excellent account of the history of commodity standards extending to 1972 is in an unpublished report, "Voluntary Industry Standards," by Joan Koenig. (History Project File; Chapter 4; Folder Commodity Standards)

After giving this history, Astin noted that engineering standards needed to be developed in a technical environment, and because of their importance to the Nation, he recommended that the commodity standards program be transferred back to the Bureau, and that a competent man be found to operate it.

This decision to use scarce resources to get more involved in this highly applied activity was, in at least a small way, a reversal of the Bureau's postwar emphasis on basic science. As stated by William A. Wildhack, associate director for engineering, "The center of gravity for NBS must be closer to the forefront of science—to help extend the limits of knowledge and the competence of other laboratories by extending the precision of measurement and providing improved measurement techniques."<sup>220</sup> But Astin clearly saw a national need that was not being met. In July 1963, the commodity standards activity, with its head Alfred S. Best, was moved from the DOC back to the Bureau. First placed in the Polymers Division, upon the reorganization of the Bureau in 1964 it became the Office of Engineering Standards in the Institute for Applied Technology.

### **Weights and Measures**

In the United States, the fixing of standards of weights and measures is a Constitutional responsibility of the Congress, which legislatively delegated it to the secretary of commerce and thence to the National Bureau of Standards. The actual control over weighing and measuring in the buying and selling of goods and services is, however, left to the states, which have the legal responsibility for enforcing those standards. From its earliest days, the Bureau has maintained an organizational unit to assist the states in carrying out this function and to provide for uniformity in weights and measures activities and laws among the states.

From 1958 to 1964, that unit was the Office of Weights and Measures (OWM). It operated a seven-part program to carry out its functions. It provided technical assistance to the states, business, and industry in the technical aspects of weights and measures; information on the design, construction and use of standards and associated measuring instruments; training of standards officials on technical matters; technical assistance with special measurement problems; help in developing laws and regulations; assistance with conference organization; and information dissemination on measurement units and systems.

Perhaps the best known of these activities was the provision of standards for mass, length, and volume to the states, along with instruction in their use. During the period, two new states joined the union, Alaska and Hawaii, both admitted in 1959. With suitable ceremony, sets of standards were provided for the new states. Research in this

---

<sup>220</sup> "Minutes of Meeting of NBS Advisory Committee on Engineering and Related Standards, May 18, 1962." (DOC; Assistant Secretary for Science and Technology; Accession 40-68B-6087; Box 28; Folder National Bureau of Standards)



Senator Edward L. Bartlett, Secretary of Commerce Lewis L. Strauss, Representative Ralph J. Rivers, and Senator Ernest Gruening inspect the measurement standards presented to Alaska at the National Bureau of Standards on March 3, 1959. The banner in the background commemorates National Weights and Measures Week.

area was directed at developing a new stainless-steel alloy suitable for the construction of new sets of standards for all the states. It was used for standard weights for Latin American countries under a program to provide those countries with sets of standards. Another advance in this area of physical standards was the design and construction of a new length-bench, along with yard and meter end standards, and appropriate stainless steel tapes. This new set would make available to the state laboratories for the first time sets of various precise-length measuring instruments. A continuing problem was the handling of pre-packaged goods, particularly aerosol containers. These required a great deal of instruction by the Bureau on how to determine the contents of such containers.



NBS designed and established a metrology training center for Latin American countries as part of the U.S. State Department's Agency for International Development program. Located at the National University, Bogota, Columbia, the laboratory was equipped with length, mass, and volume standards calibrated at NBS. At left, mass standards ranging from 1 mg to 30 kg; on the right, a 30 kg precision one-arm balance, developed for the laboratory.

In the provision of model legislation, completely new laws based on the model were enacted in Washington, New Mexico, and Missouri. For Mississippi, which in 1963 had no comprehensive weights and measures law, the Bureau carried out an intensive survey of the weights and measures activity in the state, and in March 1964, the state legislature enacted the model legislation. The model had, in fact, been developed by the National Conference on Weights and Measures, a yearly conference arranged by the Bureau and attended by most of the states, the District of Columbia, the territories, various foreign countries, equipment manufacturers and other interested parties. However, only state and local weights and measures officials are permitted to vote on issues at the conference. Others present are afforded a good way to communicate with the whole weights and measures community.

Training was another continuing function. Indeed, a laboratory for this purpose was constructed, and beginning in 1961 formal courses were given periodically. Other training occurred at the state institutions, and requests for training taxed the facilities and personnel available. The office was only a small part of the Bureau's activities but an important one in providing for uniformity in the Nation's measurement system.



In 1964, Governor Paul B. Johnson of Mississippi signed the state's first weights and measures law. The law was based on model legislation that had been provided to the state by NBS. The year before, the Bureau carried out an intensive survey of weights and measures conditions in Mississippi. (Courtesy of Mississippi Department of Agriculture and Commerce, Weights and Measures Division)

### **The International Yard and Pound; SI**

Since it was established in 1901, the Bureau, following the action set in 1893 by its predecessor the Office of Weights and Measures of the Coast and Geodetic Survey, defined the yard and the pound from the meter and kilogram international standards respectively.<sup>221</sup> The values adopted by the Bureau's predecessor and thence by the Bureau were 3600/3937 meters for the yard, and 0.453 592 4277 kilograms for the pound. The former fraction is approximately 0.914 401 83. These values were consistently adopted by the nations using the English foot-pound system. In the intervening years, however, the various users had drifted apart, particularly in the later years, and some significant discrepancies appeared. After "study and negotiation, it has developed

<sup>221</sup> National Bureau of Standards, Notice, "Refinement of Values for the Yard and the Pound," *Federal Register* 24, no. 128 (1 July 1959): 5348, microfilm. The notice is signed by A. V. Astin, Director, National Bureau of Standards, H. Arnold Karo, Director, Coast and Geodetic Survey, and F. H. Mueller, Under Secretary of Commerce.



that most of the discrepancies can be resolved . . .” by only slight changes in the definitions. As a result, on July 1, 1959, the Bureau announced that the exact definitions

$$1 \text{ yard} = 0.9144 \text{ meter}$$

and

$$1 \text{ pound} = 0.45359237 \text{ kilogram}$$

would be adopted. These units would be called the International Yard and the International Pound, and would be used by Australia, Canada, New Zealand, South Africa, and the United Kingdom. The new yard made the inch exactly 25.4 mm.

The new units caused only minor changes, for the new yard was smaller by 2 parts per million, and the new pound smaller by about 1 part in 10 million. Such changes were insignificant except for very precise determinations in the machine tool and instrument industries, in some scientific activities, and in surveying. As a result of the last fact, the old definition for the survey measure would continue to be used by the U.S. Coast and Geodetic Survey “until such a time as it becomes desirable and expedient to readjust the basic geodetic survey networks in the United States. . . .” By 1997 this had still not been done.<sup>222</sup>

\*\*\*

The metric system is the basis for the international system of units. This system is not static, but evolves as science and technology progress. Thus, the International Committee for Weights and Measures (CIPM) was instructed by the 9th General Conference for Weights and Measures (CGPM) in 1948 “to study the establishment of a complete set of rules for units of measurement . . . and to make recommendations on the establishment of a *practical system of units of measurement*. . . .”<sup>223</sup> In 1954 the 10th CGPM adopted the units of mass, length, time, electric current, thermodynamic temperature, and luminous intensity as the six base units for the “practical system.” Then, in 1960, the 11th CGPM adopted the whole practical system and the name “International System of Units,” with the abbreviation SI (from the French *Système International d’Unités*), and thus was the SI system born.<sup>224</sup>

The system contains base units, supplementary units and derived units, with stipulation of names and abbreviations. The units of the six base quantities were well known: kilogram (kg), meter (m), second (s), ampere (A), kelvin (K), and candela (cd). Later, the unit for the amount of substance—the mole (mol)—was added, making seven base quantities. Added to these were two supplementary units: plane angle (radian; rad) and solid angle (steradian; sr). A third set was comprised of twenty-seven

<sup>222</sup> Barry N. Taylor, *Guide for the Use of the International System of Units (SI)*, Natl. Inst. Stand. Technol. (U.S.) Special Publication 811; April 1995; 2d printing January 1996: 43-44.

<sup>223</sup> *The International System of Units (SI)* ed. Chester H. Page and Paul Vigoreux, Natl. Bur. Stand. (U.S.) Special Publication 330; January 1971: 1. This translation was approved by the International Bureau of Weights and Measures of its publication “Le *Système International d’Unités*.”

<sup>224</sup> *Comptes Rendus des Séances de la Onzième Conférence Générale des Poids et Mesures*, Paris, 14-20 Octobre, 1960: 65-70.

derived units, many of which have special names and are formed by combinations of the base units. Examples are area ( $\text{m}^2$ ), velocity ( $\text{m/s}$ ), force (newton;  $\text{N}$ ,  $\text{kg} \cdot \text{m} \cdot \text{s}^{-2}$ ), energy (joule;  $\text{J}$ ,  $\text{N} \cdot \text{m}$ ,  $\text{m}^2 \cdot \text{kg} \cdot \text{s}^{-2}$ ), power (watt;  $\text{W}$ ,  $\text{J/s}$ ), and potential difference (volt,  $\text{V}$ ,  $\text{W/A}$ ). Also stipulated in the 1960 CGPM ruling were the names and abbreviations for powers of 10, ranging from pico (p) for  $10^{-12}$  to tera (T) for  $10^{12}$ . The conference also agreed upon rules and style conventions for printing that were designed to bring order to scientific notation.

The number of base units has remained at seven but the number of derived units has grown. The 1995 edition of SP 330, the official U.S. document on the SI system, lists fifty-four derived units which form the "coherent system of SI units." Eleven derived units have no special names (e.g., current density,  $\text{A/m}^2$ ) and are expressed in terms of the base units; twenty-one derived units have special names and symbols (e.g., frequency, hertz,  $\text{Hz}$ ,  $\text{s}^{-1}$ ; pressure, pascal,  $\text{Pa}$ ,  $\text{N/m}^2$ ); and twenty-two derived units are expressed by means of SI derived units with special names (e.g., surface tension, newton per meter,  $\text{N/m}$ ,  $\text{kg/s}^2$ ). The two supplementary units, the plane angle (radian,  $\text{rad}$ ,  $\text{m} \cdot \text{m}^{-1} = 1$ ) and the solid angle (steradian,  $\text{sr}$ ,  $\text{m}^2 \cdot \text{m}^{-2} = 1$ ), were eliminated as a separate group and are now included with the other derived units with special names and symbols. The powers of 10 were expanded to  $10^{-24}$  (yocto, y) and  $10^{24}$  (yotta, Y).<sup>225</sup>

The seeming complexity of the SI system is in the details. In fact, it has brought considerable order to the expression of quantities in the physical sciences as well as engineering and chemistry.

## A TOUR OF THE DIVISIONS

### Optics and Metrology

The big news in the work of this division was in basic and engineering length standards, as already detailed in the section on Standards Matters. But in a related activity in response to industry needs as expressed in a series of conferences held at the request of the Aerospace Industries Association, the Bureau established a Gear Metrology Laboratory in the Metrology Division in 1962. In work designed to standardize gear measurement, equipment was acquired for calibrating involute profile masters, concentricity, and spacing of gear teeth, much of it on loan from industry and interested Government agencies. It was believed to be the only laboratory of its kind in the world.

The division also had responsibility for photometric standards, and in 1958 entered into a program proposed by the BIPM for international adoption of uniform units of luminous intensity and luminous flux for the carbon-filament lamp, the vacuum-tungsten lamp, and the gasfilled-tungsten lamp. The units would be based on their average magnitudes found by applying the Bureau-developed primary standard of a blackbody at the freezing point of platinum. Because of the difficulty of operating

<sup>225</sup> Taylor, *Guide for the Use of the International System of Units (SI)*: iv, 3-8.

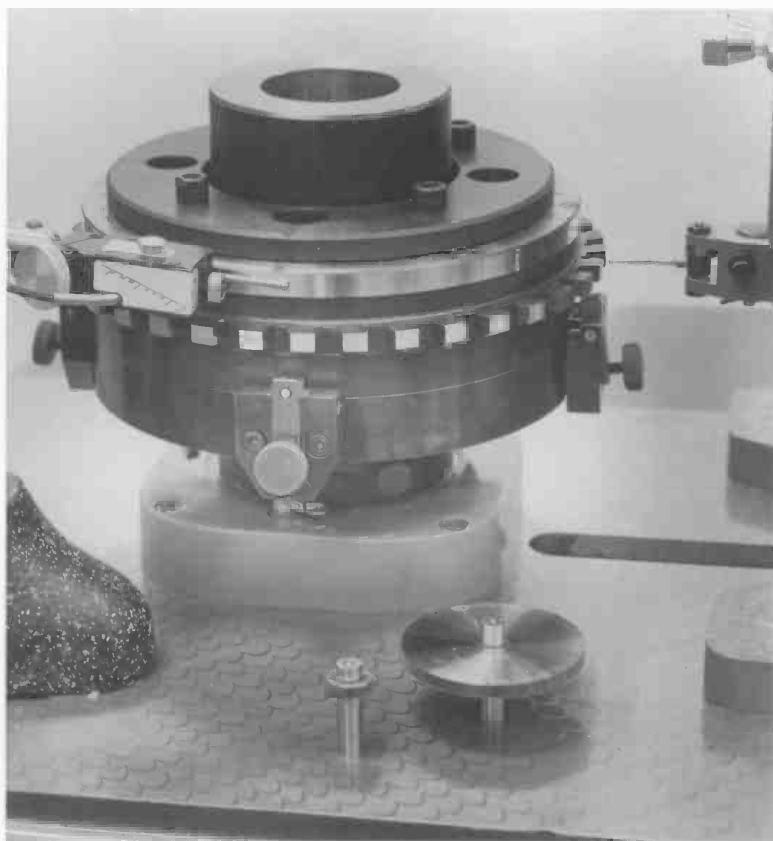

A master index plate in position for calibration in the Gear Metrology Laboratory at NBS. This plate was used, in turn, to calibrate industrial instruments that checked gear indexing and deviation from concentricity. The two master gears in the foreground could also be calibrated with the equipment shown.

a high-temperature blackbody standard and of assigning uncertainties to it, it was never used for calibrations at the Bureau or anywhere else. Nevertheless, it formed an important conceptual step in relating photometric units to the base units of the measurement system.<sup>226</sup>

Other activities carried out in the division included color measurement and standards, mass calibrations (transferred in 1960 from the Mechanics Division), various aspects of aircraft and landing field lighting (all on transferred funds), lens design, and research in various parts of the photographic process.

<sup>226</sup> Bruce W. Steiner, private communication.

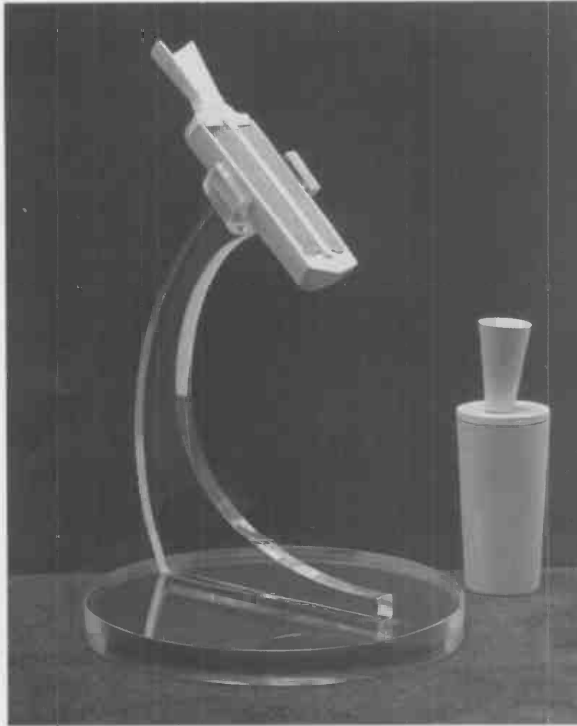

In 1908 Charles W. Waidner and George K. Burgess suggested the use of a blackbody (one which completely absorbs all radiation incident upon it), totally immersed in a bath of freezing platinum, as a primary standard of luminance. This was experimentally realized 20 years later using fused thoria placed at the bottom of a sight tube. Molten platinum was contained in a thoria crucible. By 1933 the International Committee of Weights and Measures had accepted both the blackbody concept and the freezing platinum reference. This model of the Waidner-Burgess standard of light shows in cross-section the thoria crucible, metal in the space occupied by the freezing platinum, and a thoria tube (the blackbody) in the center.

## Mechanics

Charged with the custody of the measurement standards for mechanical quantities, the work of the Mechanics Division needed to develop measurement techniques and standards for sound pressure and intensity, shock, vibration, force, strain, pressure, volume, and rate of flow. It provided services for the calibration of measuring instruments for these quantities.

The most notable accomplishments during the period were in pressure and force standards. Due to the urgency of calibrating large force-measuring devices essential for the Nation's space and military programs, it was the first division to move to the Gaithersburg site. In the main, the program for the present period was a continuation of work previously discussed. Here we give only a few noteworthy advances to give a flavor of the activities.

With the Nation very much concerned with jet engines, it is not surprising that work continued in this area. One of the concerns was the measurement of temperature in the jet engine. Work throughout the period on thermocouples of various kinds led to the 1964 publication of reference tables for several types (primarily 60 percent iridium versus 40 percent rhodium-iridium alloy of several compositions) that covered the temperature range from  $-100^{\circ}\text{C}$  to  $2150^{\circ}\text{C}$ .<sup>227</sup>

<sup>227</sup> L. O. Olsen and P. D. Freeze, "Reference Tables for the Platinel II Thermocouple," *Journal of Research of the National Bureau of Standards* 68C (1964): 263-281; G. F. Blackburn and F. R. Caldwell, "Reference Tables for Thermocouples of Iridium-Rhodium Alloys Versus Iridium," *Journal of Research of the National Bureau of Standards* 68C (1964): 41-59.

In work more in keeping with its scientific disciplines, the division maintained reference flow-rate facilities for the calibration of devices that metered the flow of fuel to jet engines. Fuel metering must be very precise for optimum engine performance, and metering components require precise adjustment and test prior to installation. First operated under the sponsorship of the Navy Bureau of Aeronautics, sponsorship of these facilities shifted to the Bureau of Naval Weapons in 1963. It was an arrangement similar to that of the military in the Electronic Calibration Center.

A continuing area of study throughout the whole period was infrasonic waves in the atmosphere. Practically always present, these waves have periods ranging from one second to 30 seconds and are approximately the same intensity as speech, but of course, they cannot be heard. Some types were correlated with tornadoes more than 1000 miles distant, with earthquakes, and with magnetic storms.<sup>228</sup> Others, with periods of about 6 seconds, arrived from the east and were thought to be caused by waves breaking on the Atlantic shore. The infrasonic waves were complementary to seismic waves discovered in the study of earthquakes.

In the large reorganization of 1960, the Heat Division's Rheology Section was transferred to the Mechanics Division, where it found a more natural home. The section was concerned with the properties of viscoelastic substances—polymers are the prototypical materials—which it studied by both experimental and theoretical work. Concerned with the explanation of the results of stress-relaxation experiments at high extensions, three of the investigators formulated a nonlinear theory of viscoelastic substances which worked remarkably well.<sup>229</sup> It was a significant advance in a recondite area.

### **The Electricity Division Stimulates Polymer Science**

One of the divisions most concerned with basic measurement standards and calibrations was the Electricity Division, which started the period as Electricity and Electronics, but reverted to Electricity upon transferring personnel to the Instrumentation Division. During the period it continued its work on basic measurement standards, notably undertaking another absolute determination of the ampere occasioned by the measurement of the gyromagnetic ratio of the proton. Equally notable was the determination by NBS of the unit of electrical resistance based on an approximately 1 picofarad capacitor invented by A. M. Thompson of the Australian National Measurement Laboratory. The capacitance of this unit could be calculated accurately simply from its dimensions. This capacitor was used to establish the value of a 0.01 microfarad capacitor which, when used with a frequency-dependent bridge, established the value of a 10 000 ohm resistor. When compared with the Bureau's prevailing 1 ohm standard resistors, the results showed that the standard resistors used to maintain the NBS unit of resistance did so with an estimated accuracy of 2 parts per million. Another effort

---

<sup>228</sup> "Unusual Recordings of Infrasonic Disturbances in the Atmosphere," *Technical News Bulletin* 44 (1960): 206-208.

<sup>229</sup> B. Bernstein, E. A. Kearsley, and L. J. Zapas, "A Study of Stress Relaxation with Finite Strain," *Transactions of the Society of Rheology* 7 (1963): 391-410.

was the redetermination of the Faraday constant by the electrolytic dissolution of metallic silver. The new determination gave a value of  $96516.5 \pm 2.1$  coulombs per gram-equivalent weight on the physical scale, better by 0.008 percent than the previous value.

In a joint venture with the Atomic Physics Division, the measurement of another fundamental constant was carried out when Raymond L. Driscoll of Electricity and Peter L. Bender of Atomic Physics made an absolute determination of the gyromagnetic ratio of the proton. This quantity is important both for practical reasons and for basic nuclear physics. Since it is the constant of proportionality that connects the precession frequency of the proton to the value of the magnetic field in which it is placed, its knowledge reduces the determination of magnetic field strength to the measurement of a frequency, and since protons are readily available in water, the experimental material is always at hand. On a basic-science level, theory gives the quantity as the ratio of the magnetic moment of the nucleus to its angular momentum.



Raymond L. Driscoll with the apparatus he and Peter L. Bender used to redetermine the gyromagnetic ratio of the proton in 1958. The solenoid (center) whose magnetic field could be precisely calculated from its known dimensions, caused the protons in a water sample to precess with an accurately measurable frequency. The proton gyromagnetic ratio was then calculated from the precession frequency and the precisely known field strength. The large coils which surrounded the apparatus counterbalanced the earth's magnetic field.

Thus the knowledge of the gyromagnetic ratio in absolute units for the simplest nucleus, the proton, permits the determination of the magnetic moment of any other nucleus, provided only that its spin is known. Moreover, the gyromagnetic ratio is given by an expression containing only fundamental constants, so its knowledge and accurate measure is a check on their values.

While the Bureau was not the first to measure the gyromagnetic ratio of the proton, it did carry out a determination in 1950,<sup>230</sup> but an iron-core magnet had to be used because measurements could not, at that time, be made at low field strengths. As a result the uncertain measurement of the magnetic field of the magnet somewhat degraded the accuracy. In the intervening years, however, science had progressed to the point where measurements at low fields could be made. Hence Driscoll and Bender joined forces to make another absolute measurement, this time using as a source of magnetic field the same solenoid that had been used by Driscoll for the realization of the absolute ampere; it provided the most accurate and best-known field available. The value obtained was only slightly smaller than the previous measurement,  $(2.67513 \pm 0.00002) \times 10^4 \text{ gauss}^{-1} \text{ sec}^{-1}$  as compared to  $(2.67523 \pm 0.00006) \times 10^4 \text{ gauss}^{-1} \text{ sec}^{-1}$ .<sup>231</sup> With the value related directly to the fundamental unit of current, it was an experiment that only the Bureau could carry out. Basic science had a new, more accurate fundamental quantity whose value, interacting with other fundamental quantities would improve all of them. Driscoll and Bender received the first Stratton Award for their work.

But perhaps more than any other, the division's activities in the study of magnetic and dielectric properties of matter led to new directions for the division and the Bureau. The former study developed almost into atomic physics when investigations were begun on the nuclear magnetic resonance of various ferromagnetic alloys. The latter study, however, was to have an enormous effect on materials science both at the Bureau and in the scientific community at large.

It began with the hiring of John D. Hoffman, whose father, James I. Hoffman, a renowned analytical chemist, had been a senior scientist in the Bureau's Chemistry Division for many years. An expert in the dielectric properties of the normal paraffins, the younger Hoffman was hired in 1954 to begin a study of dielectric materials in the Polymer Structure Section of the Organic and Fibrous Materials Division. He assembled a group in the Polymer Structure Section and began an intensive investigation of polymers as prototype dielectric materials. In 1956, in order to consolidate in a single group much of the research on dielectric materials and associated standardization work at frequencies below 30 kHz, Hoffman's group was moved to the Electricity Division as the Dielectric Section. The first polymer chosen for study was polychlorotrifluoroethylene (PCTFE) because it had a dipole moment at right angles to the polymer chain, but no side groups capable of reorientation independent of the backbone polymer chain. Thus, any observed relaxation processes could be unambiguously

<sup>230</sup> H. A. Thomas, R. L. Driscoll and J. A. Hipple, "Measurement of the Proton Moment in Absolute Units," *Physical Review* 78 (1950): 787-790.

<sup>231</sup> R. L. Driscoll and P. L. Bender, "Proton Gyromagnetic Ratio," *Physical Review Letters* 1 (1958): 413-414.

attributed to motions of the polymer chain itself. These ideas led to a thorough study of this polymer, for which data over the temperature range from  $-50^{\circ}\text{C}$  to  $+250^{\circ}\text{C}$  and the frequency range from 0.1 Hz to 8.6 GHz were obtained.<sup>232</sup>

The most interesting aspect of the study—and the one that led to interest from a community far broader than that simply concerned with dielectrics—is the fact the PCTFE is a crystalline polymer and, like practically all such polymers, is a mixture of amorphous and crystalline regions, with the same chain generally existing in both phases. By applying appropriate quenching techniques during sample preparation, the degree of crystallinity could be varied from essentially pure amorphous to about 80 percent crystalline. It was the attempt to relate the bulk properties of the polymer to this variable degree of crystallinity that led the study beyond purely dielectrics and into broader aspects of materials science.

To understand how this came about, a few words have to be said about other events in polymer science at the time. In 1957, Andrew Keller at Bristol University discovered the then amazing fact that, in crystallization from dilute solution, single crystals of polymers could be formed. They were strange objects indeed: thin lamellae of the order of 10 nm in thickness, but with lateral dimensions of several micrometers. But most astounding was the fact that the chain axis appeared to be approximately normal to the surfaces of the lamellae, and since the polymer chains were several hundreds of nanometers long, this meant that the polymer chains folded back on themselves at the broad surfaces of the lamellae. A crucial result was the demonstration that the thickness of the lamellae depended on the crystallization temperature: the higher the temperature, the thicker the lamellae.

An important problem Hoffman and his associate James J. Weeks addressed concerned the melting of the bulk polymer. It was known that the melting point as determined, for example, by volume change, increased as the rate of heating decreased, but no limit seemed to be approached. And, for polyethylene, the observed melting point was much lower than the melting point of the n-paraffins extrapolated to very long chain lengths. Hoffman and Weeks, adopting a model that the crystalline regions of the polymer in the solid state also consisted of lamellae, reasoned that such thin crystals would have a melting point that depended on their thickness, hence the crystallization temperature, and that this melting point would be much lower than that of a bulk crystal composed of fully extended polymers chains. Following this reasoning, they produced samples of polymers crystallized at different temperatures.<sup>233</sup> They determined the melting point of these samples under rapid heating since polymers require a substantial undercooling in order to crystallize (an easy task under the polarizing microscope since the polymer crystals are highly birefringent). This procedure

---

<sup>232</sup> A. H. Scott, D. J. Scheiber, A. J. Curtis, J. I. Lauritzen, Jr., and J. D. Hoffman, "Dielectric Properties of Semicrystalline Polychlorotrifluoroethylene," *Journal of Research of the National Bureau of Standards* 66A (1962): 269-305.

<sup>233</sup> J. D. Hoffman and J. J. Weeks, "Melting Process and the Equilibrium Melting Temperature of Polychlorotrifluoroethylene," *Journal of Research of the National Bureau of Standards* 66A (1962): 13-28.



precluded structural rearrangement as much as possible. They then plotted these observed melting points against the crystallization temperatures. This plot gave them a straight line with positive slope, which they extrapolated to the (unobservable) line for which the melting point and the crystallization temperature were equal. This gave them the equilibrium melting point: a value of 224 °C, compared to 218.2 °C for the highest melting point obtained directly. This procedure was widely copied and is now the standard means for determining polymer melting points.

Important as that development was, it was by no means the most important one for polymer science. In a purely theoretical study, Hoffman and John I. Lauritzen, Jr., his long-term associate, proposed a theory of polymer crystallization.<sup>234</sup> Far too complex to record in detail here, suffice it to say that it was a nucleation theory. In this model, the lamellae grow laterally by deposition along the lateral edges of the crystal. The nucleation barrier is the deposition of a straight segment of polymer chain (called a "stem" in the argot of the science) on the lateral edge of the crystal, followed by the subsequent folding of the chain at the surface of the lamella. These processes increase the free energy of the crystal and form a barrier to crystallization. More of the chain then deposits adjacent to the first-laid stem, folds at the other lamella surface, and continues the process. Each of these subsequent events lowers the free energy of the crystal, and the rate constant for each of these steps can be determined by standard kinetic theory. The full set of kinetic equations is easily written and, with somewhat more effort, solved. The rate of growth is obtained, with the lamella thickness as a parameter. An ensemble averaging of the growth process yields a value for the thickness, and this value can be interpreted as the optimum thickness for the most rapid growth. Both the growth rate and the thickness are given by the theory as functions of the undercooling: the growth rate as a negative exponential of the reciprocal of the undercooling, and the thickness as inversely dependent on it. This theory and its subsequent elaborations stimulated an immense amount of theoretical and experimental activity in the field of polymer science. Its predictions, with subsequent clarifications, proved largely correct. It has become one of the mainstays of polymer science, and its concepts are still the subjects of investigation.

In June 1964, with the retirement of Gordon Kline, chief of the Polymers Division, Hoffman assumed that position. His dielectrics/polymer-science group also was moved to the Polymers Division. Thus, in carrying out research on its basic measurement mission, the Electricity Division stimulated the birth of a new branch of polymer science.

---

<sup>234</sup> J. I. Lauritzen, Jr., and J. D. Hoffman, "Theory of Formation of Polymer Crystals With Folded Chains in Dilute Solution," *Journal of Research of the National Bureau of Standards* 64A (1960): 73-102. Two other theoretical treatments of this phenomenon followed the Lauritzen-Hoffman paper: F. P. Price gave a quasi-equilibrium treatment in "Markoff Chain Model for Growth of Polymer Single Crystals," *Journal of Chemical Physics* 35 (1961): 1884-1892, and F. C. Frank and M. Tosi in "On the Theory of Polymer Crystallization," *Proceedings of the Royal Society (London)* A263 (1961): 323-339 presented a variation of the Lauritzen-Hoffman work. The latter paper gives an elegant solution of the kinetic equations and an important discussion of the rate constants.

## Radio Standards

The most far-reaching activity of the Radio Standards Division was the development of the atomic frequency standards discussed earlier in this chapter. But the division (later a Laboratory with two divisions) was concerned with a plethora of other standards as well.<sup>235</sup> There were standards, measurement methods, and calibrations for attenuation, impedance, power, voltage, current, noise, field strength, pulses, and phase shifts. The ever-expanding frequency range made certain that the division did not run out of urgent work. In addition, there was research on materials of importance to high-frequency radio up to millimeter waves at about 100 GHz. While still assiduously developing measurement methods and calibrations, the background work became ever more basic and fundamental. In 1962 the division was split into two: Radio Standards Physics, where most of the background research was carried out, and Radio Standards Engineering, where the standards and calibrations work was done.



A Bureau scientist makes attenuator and linearity calibrations on a high-frequency field-strength meter.

<sup>235</sup> Snyder and Bragaw, *Achievement in Radio*: 360-402, 619-622.

Much of the work was concerned with microwave frequencies and millimeter waves. The latter formed a relatively unexplored region of the electromagnetic spectrum. With such short wavelengths, optical techniques were applicable, and both Michelson and Fabry-Perot interferometers were built for use in the millimeter-wave range. The latter instrument used ingenious reflecting plates made from highly polished metal or silvered glass flats with accurately spaced and dimensioned holes. In radio parlance, the reflecting plates, placed face-to-face as in a Fabry-Perot interferometer, formed a resonant cavity which, for a given wavelength, could be brought into resonance when the spacing between the plates corresponded to an integral number of half wavelengths. At this point the output through the holes is a maximum. Thus the device could be used both as a source of millimeter waves and as a means of measuring their wavelength. In fact, this was done with a relative uncertainty of 0.04 percent.

With a new means of measuring wavelength, and a world-leading capability in measuring frequency, it was only natural that a redetermination of two fundamental constants be made. The speed of electromagnetic radiation (the same as the speed of light) was determined utilizing the Michelson, rather than the Fabry-Perot, interferometer. Using 6 mm waves and a klystron of very well-known frequency, the new determination produced no surprises. Another measurement was made using gamma rays and the Mössbauer effect. And in a microwave study of the spectrum of singly ionized helium, the fine-structure constant was determined.



A Fabry-Perot interferometer, designed to operate at 3 mm to 4 mm, was used as the cavity resonator for a hydrogen cyanide gaseous maser. G. L. Strine was photographed in 1961 adjusting the parallelism of the perforated reflectors.

In an investigation that was not directed at a fundamental constant, but borrowed from spectroscopy, the Fabry-Perot millimeter wave interferometer was used to measure the Stark shift in a rotational transition in methyl cyanide at a frequency of 37 GHz. This led to a method for the measurement of high voltages with a high precision of 1 part in  $10^8$ , albeit with a relative uncertainty of 1 part in  $10^4$ .

There were other areas of basic research. Plasmas and their interaction with radiation were studied as part of the Bureau's plasma program. Work in materials was "primarily directed toward advancing the present understanding of solid state phenomena as well as toward improving and developing standards and measuring techniques for determining material properties."<sup>236</sup> In 1963 work on magnetics was concerned with the change in elastic modulus of ferrites upon magnetization. Other efforts included time dependent magnetization effects; improvement in permeability measurement technologies; shape effects in the determination of gyromagnetic ratios; studies of ferromagnetic resonance and the losses due to spin waves; and the investigation of electron paramagnetic resonance in iron-doped synthetic quartz.

In dielectrics, the work was more directly concerned with standards. An international comparison with Canada and England of the dielectric constant of fused silica, glass, and alumina showed close agreement for the real part, but a disagreement on the imaginary part, which is much more difficult to measure accurately. Nevertheless the results were used to improve knowledge of the dielectric constants of glass and silica, and standard samples were made available.

Along with efforts in applied mathematics and numerical analysis, the division conducted research in mathematical physics—almost a small version of the applied mathematics division. The studies were viewed as end products in themselves, as well as providing theoretical foundations on which continued work could be based and providing the background for mathematical and physics consultation. One example of the work was the application of a new theory on the quantum statistics of multi-component systems to the calculations of the properties of a plasma model which was far more realistic than the familiar electron-gas model.

Lest we leave the impression that the division failed to carry out its main mission of providing standards and calibrations in the radio field, we list four topics from the 1962 report:

1. The provision of a method for the measurement of pulse power. With a range from 0.25 W to 10 kW, a limit of error of  $\pm 3$  percent, pulse widths as small as 5  $\mu$ s, and a frequency range of 3 KHz to 1 GHz, the method formed the basis for a new calibration service.
2. Radio-frequency voltage-calibration services were expanded to include 500 MHz, 700 MHz, and 1000 MHz.
3. The high-frequency impedance calibration service was improved by the addition of new instrumentation and hardware.

---

<sup>236</sup> Annual Report, 1962: 51.

4. The calibration uncertainty of attenuators for field strength meters was reduced from  $\pm 0.8$  db to  $\pm 0.2$  db over the frequency range of 400 MHz to 1000 MHz, and the attenuation range was increased to 150 db.

## Heat

With responsibility for the temperature scale, the Heat Division was deeply involved in basic thermometry research, with activities in extending the range of temperature attainment and measurement. In addition, the division did a great deal on the acquisition, analysis, and methods for the measurement of thermodynamic data. During the period its work became more basic, and it remained one of the leading scientific divisions in the Bureau.

Perhaps the activity that best illustrates the basic nature of its program is statistical thermodynamics.<sup>237</sup> Throughout the whole period there was continuous work on the development of calculation programs for the extension of thermodynamic data to an ever-wider range of temperature and density. But the effort was deeper than one limited to methods of calculation. Plasmas were as important theoretically as they were experimentally in the attainment of high temperatures, with studies of the equilibrium behavior of a fully ionized plasma in a magnetic field, and the necessary modifications of standard treatments of high-temperature gases to take into account the presence of long-range coulomb interactions. Theoretical calculations of dense gases were a continuing interest, with an analysis of the underlying assumptions made in traditional calculations. A two-year calculation of the pair distribution function in dense gases and liquids was carried out, but the application to a hard-sphere model showed no evidence of a gas-liquid phase transition—that nirvana of the theory of liquids. Continued work in this field would make the Bureau a center of statistical thermodynamics research.

Two programs illustrate that this emphasis on more basic work did not lessen the Bureau's concern with national problems. Both were concerned with the space race and military considerations and both were supported by the military, but now the work was basic research, not ordnance development as it had primarily been in pre-AD-X2 days.

One program was concerned with data on thermodynamic properties. In 1959 the recently formed Advanced Research Projects Agency (ARPA) of the DOD began to support the Bureau for a program to determine the thermodynamic properties of the light elements and their compounds, using the argument that "one of the most effective means of developing more efficient chemically propelled rockets is to select particular fuel materials which generate more power per unit mass and lose less power in the exhaust products." In principle, such fuel materials should be composed of light elements and their compounds, but more data were required before selection for top performance could be made.<sup>238</sup> The resulting effort was an interdivisional, multi-disciplinary program coordinated by Charles W. Beckett of the Heat Division. Thermodynamic data on lithium, beryllium, aluminum, and zirconium, and their compounds

<sup>237</sup> Annual Report, 1958: 21-22.

<sup>238</sup> Annual Report, 1960: 53-54.

with hydrogen, oxygen, fluorine, and chlorine, were determined and disseminated. Many properties were ascertained. For example, the entropy of lithium aluminum hydride by low-temperature thermal measurements was determined to help in predicting under what conditions this new compound would form or decompose, and the very-high-temperature aluminum-oxygen gaseous system was investigated. But most important were heats of formation. Measurements accurately determined these heats for the alkali-metal perchlorates and ammonium perchlorate, an oxidizer used in many solid-fueled rockets. Similar data were obtained on compounds of beryllium, aluminum, and lithium with oxygen, fluorine, and chlorine. That none of these exotic compounds achieved the status of rocket fuels illustrates on the one hand the tenor of the times in the military space race and, on the other, the various by-ways that need to be explored in a crucial research effort.

Far better known, and with important effects on the Bureau's development, was a complementary, but considerably more exploratory, program on free radicals.

### *A Program on Free Radicals*

In 1954, Herbert P. Broida, physicist in the Temperature Measurement Section of the Heat and Power Division, and John R. Pellam, chief of the Cryogenics Section of the same division, published a paper on certain new and strange phenomena they had observed.<sup>239</sup> They had passed a stream of nitrogen through an electrical discharge tube and had frozen the resulting gas on the walls of a chamber kept at the temperature of liquid helium. They were surprised to see that the resulting deposit gave off a strong green glow and, occasionally, small patches erupted with a blue flash, like a miniature explosion. They hypothesized that during the discharge, nitrogen atoms—the most elementary form of free radicals—had formed and then became trapped in the solid molecular nitrogen frozen on the chamber walls. The green glow and blue flashes must be connected to the presence of these atoms. The green glow persisted for several minutes after the discharge tube was turned off. The experiments were continued with hydrogen, oxygen, and water vapor and led to similar conclusions about the coexistence of radicals and molecules at these low temperatures.

The interest in rocketry, hence energetic fuels, in the mid-fifties had made free radicals into subjects of interest.<sup>240</sup> Calculations showed that radicals of such gases as hydrogen, nitrogen, and oxygen would far surpass any other fuels for rocketry in terms of the immense energy released upon their recombination. Therefore, despite the difficulty in forming and storing them, they were under active study. The great importance of the Broida-Pellam result was that it indicated a possible means of storing atomic free radicals, i.e., of stabilizing them, something that was essential before they could be used.

---

<sup>239</sup> H. P. Broida and J. R. Pellam, "Phosphorescence of Atoms and Molecules of Solid Nitrogen at 4.2 °K," *Physical Review* 95 (1954): 845-846.

<sup>240</sup> Maurice W. Windsor, "Trapped Radicals in Propulsion," in *Formation and Trapping of Free Radicals*, Arnold M. Bass and Herbert P. Broida, eds. (New York: Academic Press, 1960), 387-409.

With advice from technical committees, and with the results of the Broida-Pellam experiment, the Department of Defense—specifically the Army Ordnance Department, with its long history of support of work at the Bureau—in September 1956 began a national program on the study of free radicals, concentrating on means of stabilizing them. The program involved increased support of existing work at industrial and university laboratories and the designation of the Bureau as a central research laboratory, due to its experience and its wide variety of staff and facilities.<sup>241</sup> A special section, called Free Radicals Research, was formed for the program and Broida was named its chief, with spectroscopist Arnold M. Bass as assistant chief. Work was also carried out in other sections where there was relevant expertise.

From the start there were unique aspects to the program. There were thirty to thirty-five senior scientists, about half of them from—and supported by—industry, eight from universities (six of which were foreign institutions), and the remainder from the Bureau. Three American universities provided consultants. Most interesting was the method of choosing projects. Illustrating the support of basic research and the scientific freedom of the times—and the personality and philosophy of Broida—the senior scientists were given complete freedom in their research activities, although lack of results would lead to a conversation with Broida. The style was not direction from above, but choice from below. All the work was done at the Bureau and the maximum effort took place in the latter half of 1958, when sixty-nine persons worked on the program. Designed as a three-year program, work began in September 1956 and ended in July 1959.

Cohesiveness in this free atmosphere was provided by almost constant interaction among specialists from all relevant disciplines at coffee breaks, luncheons, and weekly seminars. Many members of the Bureau staff not directly associated with the program were active participants in these discussions. Guests and visitors were welcome and attended in abundance. A bimonthly newsletter was instituted. It began with a circulation of 90 and ended with 550. The program attracted important and capable scientists, a number of whom subsequently joined the Bureau staff and achieved leadership positions. In Madison Avenue parlance, it provided advertising for the Bureau that could not have been purchased.

At the end of its three-year life, the program ended; the Free Radicals Section was abolished and the guest workers went home to their own laboratories. But the work did not cease; it continued in the home laboratories of the scientists, just the way Army Ordnance had designed the program.

---

<sup>241</sup> James W. Moyer, "Organization and Rationale of the NBS Free Radicals Program," in *Stabilization of Free Radicals at Low Temperatures*, A. M. Bass and H. P. Broida, eds., Natl. Bur. Stand. (U.S.) Monograph 12; August 1960: 1-4. This volume contains papers that give an excellent account of the scientific results of the program. Hereafter it will be referred to as Monograph 12. *Administrative Bulletin* 56-66, October 29, 1956, also gives an account of the rationale and organization of the program.

There was a very substantial scientific output from the program, although no “breakthrough” in rocket fuels. At the time the program was closed, eighty-nine scientific papers had appeared in the scientific literature or were in preparation.<sup>242</sup> With the freedom given to the senior scientists for project choice, it is not surprising to find

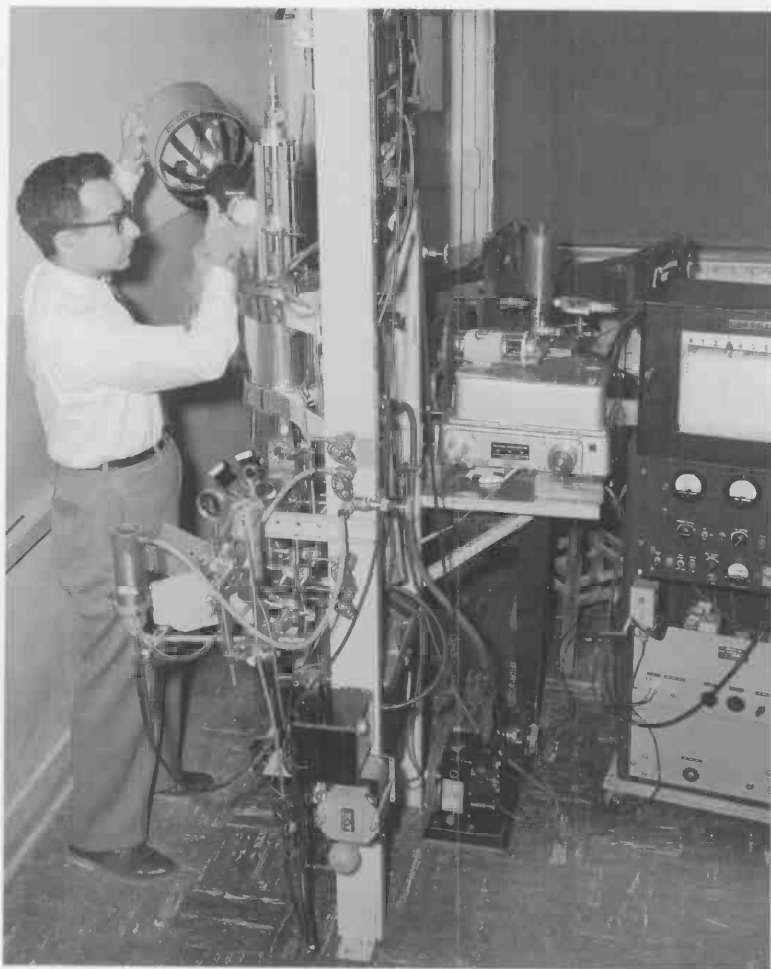

View of the equipment used at NBS in the low-temperature stabilization of free radicals. Arnold M. Bass added liquid nitrogen to the outer Dewar of the cryostat in which the free radicals were frozen into solid form. The spectroscopic equipment at right was used to study and analyze the visible and ultraviolet radiation given off by the frozen atoms.

<sup>242</sup> H. P. Broida, “La Recherche sur les Radicaux Libres au National Bureau of Standards,” *Journal de Chimie Physique* 56 (1959): 813-816.



that many scientific areas and methods were explored.<sup>243</sup> Thus, in the production of radicals, besides the original method of electric discharge pioneered by Broida and Pellam, thermal techniques, electron impact, photolysis, and gamma radiation were explored. And again, while nitrogen, oxygen, hydrogen, and water vapor were the most intensively studied substances, a number of others were investigated, including diborane, ammonia, ozone, hydrogen peroxide, methane, hydrazoic acid, and hydroxylamine.

The large number of investigators on the program provided specialized knowledge in an abundance of disciplines, so that a whole litany of techniques in various scientific areas were brought to bear on the studies. Spectroscopy was an important area, with a number of studies in absorption and emission spectra. X-ray diffraction studies on various radical-containing solids at the temperature of liquid helium were carried out by Bureau specialists, necessitating the development of specialized equipment in the process. Thermometric energy-release studies were carried out on a number of species and for a variety of processes. A number of studies of chemical reactions and their kinetics were performed. The uniquely applicable technique of electron spin resonance was applied with illuminating results, particularly with respect to the demonstration that the ground state of nitrogen atoms in the matrix of nitrogen molecules is stabilized at the low temperatures used. Theoretical studies formed a significant part of the program.<sup>244</sup> They were concerned with the deposition of the radical-molecule mixture in the gas on to the cold substrate, with the kinetics of the process, with the emission and absorption of energy, with the nature of the forces and structures that trap atoms in the lattice, with the thermodynamics of radicals, and with the mechanisms and kinetics of the disappearance of trapped radicals. Not the least of the results of the program were the development of methods for handling large quantities of liquid helium, the development of new designs of dewars and their commercial availability, and the development of more specialized techniques.

Thus, while no radical rocket propellant ever reached the stage of contemplation, the science of molecular stability was given a significant boost, the utility of low temperatures in research was made known beyond the confines of "classical" low temperature physics, and the Bureau substantially enhanced its reputation in basic experimental and theoretical chemistry.

### Atomic and Molecular Physics

As one of the Bureau's elite scientific units, the Atomic Physics Division continued its work on various aspects of spectroscopy, electron physics, solid state physics, and other more specialized topics, including the determination of the gyromagnetic ratio of

---

<sup>243</sup> Milton D. Scheer, "Experimental Aspects of the National Bureau of Standards Free Radicals Program," in *Stabilization of Free Radicals at Low Temperature*, A. M. Bass and H. P. Broida, eds., Natl. Bur. Stand. (U.S.) Monograph 12; August 1960: 7-20.

<sup>244</sup> C. M. Herzfeld, "A Survey of Theoretical Work on Trapped Radicals at the National Bureau of Standards," in *Stabilization of Free Radicals at Low Temperature*, A. M. Bass and H. P. Broida, eds., Natl. Bur. Stand. (U.S.) Monograph 12; August 1960: 21-36.

the proton (described under the Electricity Division), the precision determination of the Rydberg constant,<sup>245</sup> and work on a portable rubidium-based atomic-frequency standard. From its enormous outpouring of scientific work, we select three topics to give a flavor of the division's work: laboratory astrophysics, synchrotron radiation, and electron physics.

Not surprising for the birthplace of JILA, the division carried out a large effort related to astrophysics. Indeed, astrophysics was one of the main applications of the work done on atomic energy levels, transition probabilities and collision cross-sections. In 1957, at the very beginning of the period, a High Altitude Observatory was established on Mauna Loa in Hawaii, where the oxygen content of the Martian atmosphere was measured and the presence of molecular hydrogen in the atmosphere of Jupiter was verified.

Practically all the work was laboratory based and concerned with spectroscopy and related studies—hardly surprising considering the division's history. Thus, one of the areas of study was in low-energy collision cross sections for "selected processes of critical importance to astrophysics and plasma physics." This work was concerned with electron collisions with neutral atoms and negative ions, a process thought to "play a leading role in determining properties of the solar atmosphere."<sup>246</sup> The photo-detachment of electrons from negative ions, particularly  $H^-$ ,  $O^-$ , and  $C^-$ , was featured. The experimental work was buttressed with theoretical studies.

The work in atomic spectroscopy, where NBS had held a predominant position for many years, was centered on the rare earth elements. The three volumes of Charlotte Moore Sitterly's widely used compilation, *Atomic Energy Levels*, which were published in 1949-1958, covered all the periodic table except for the lanthanides (rare earths) and actinides.<sup>247</sup> Wavelength measurements of spectral lines from improved light sources and the use of powerful new computer methods were necessary for successful energy-level analyses of some of the most complex rare-earth spectra. Such analyses of several of these spectra were first successfully carried out at NBS by the early 1960s, and work on these elements continued until the 1978 publication of the compilation *Atomic Energy Levels—The Rare-Earth Elements*.<sup>248</sup>

---

<sup>245</sup> W. C. Martin, "Value of the Rydberg Constant," *Physical Review* 116, no. 3 (1959): 654.

<sup>246</sup> Annual Report, 1960: 61.

<sup>247</sup> Charlotte E. Moore, *Atomic Energy Levels As Derived from the Analysis of Optical Spectra. Vol. I—Vol. III*. Natl. Bur. Stand. (U.S.) Circular 467; 1949-1958.

<sup>248</sup> W. C. Martin, R. Zalubas, L. Hagan, *Atomic Energy Levels—The Rare-Earth Elements. The Spectra of Lanthanum, Cerium, Praseodymium, Neodymium, Promethium, Samarium, Europium, Gadolinium, Terbium, Dysprosium, Holmium, Erbium, Thulium, Ytterbium, and Lutetium*. Natl. Bur. Stand. (U.S.) NSRDS 60; April 1978.



Lewis M. Branscomb inserted a filter into the optical system of the apparatus developed at NBS for studying the photodetachment of electrons from negative atomic and molecular ions (1961). The studies had direct bearing on ionospheric theory and research and on the study of plasmas.

Atomic transition probabilities were important for the evaluation of the temperature and state of equilibrium of stellar atmospheres, and for determining the relative abundance of elements in stars. Thus, with support from ONR and ARPA, a data center to gather and index all published information on atomic transition probabilities was formed in 1961. By 1962, a bibliography of all known publications on these probabilities was produced and published as NBS Monograph 50. At almost the same time, a 562-page monograph on the transition probabilities of seventy elements was issued.<sup>249</sup>

<sup>249</sup> B. M. Glennon and W. L. Wiese, *Bibliography on Atomic Transition Probabilities*, Natl. Bur. Stand. (U.S.) Monograph 50; August 1962; C. H. Corliss and W. R. Bozman, *Experimental Transition Probabilities for Spectral Lines of Seventy Elements*, Natl. Bur. Stand. (U.S.) Monograph 53; July 1962. The latter monograph was the first Bureau publication produced by completely automatic methods. The computer-produced tape of the calculations was converted to a binary tape in the proper format to drive an automatic phototypesetting machine, which produced film positives of the pages ready for producing the final printing plates.

Unquestionably, the most exciting development of the period was the use of radiation from the electron synchrotron for spectroscopy in the far, or vacuum, ultraviolet. This research would uncover a host of exciting new phenomena and would lead to the nationwide development of new scientific facilities that, at this writing, is still continuing.

### *A New Light Source*

When the Bureau placed its new 180-MeV synchrotron into operation in the 1950s, it was already known theoretically that the circulating electrons in the machine emitted light.<sup>250</sup> It was expected that the wavelength of the light would form a pure continuum with the peak power emitted at a wavelength that would become shorter the higher the energy of the electrons. Due to relativistic effects, the light was predicted to be emitted in a narrow beam tangent to the electron orbit, and since the beam sweeps across a point on the orbital plane as the electrons sweep around their orbit, the radiation on an experimental device like a spectrometer slit would be spatially uniform in the lateral direction. Moreover, exactly on the orbit plane, the light would be completely polarized with the electric vector in the orbital plane, while in directions making small angles above and below the orbital plane there would be a small admixture of light with the perpendicular polarization, the amount depending on the angle. Experiments in 1948 on the General Electric 70 MeV synchrotron confirmed many of these expectations, and a much more complete set of experiments in 1956 on the Cornell 300 MeV synchrotron confirmed them in greater detail.<sup>251</sup> This analysis, however, was photographic, with consequent limitations in determining intensity profiles. The later work, particularly at the Bureau and DESY (an electron synchrotron in Hamburg, Germany), was photoelectric and supplied the really detailed confirmation. The wavelength of the Bureau machine was expected to extend into the vacuum ultraviolet, and it was a perfect source for absorption spectroscopy in this difficult wavelength range.

While interested in such spectroscopy, the Bureau was also interested in synchrotron light because it was at least conceivable to develop it into an absolute radiometric standard. Thus in 1961 Lewis Branscomb, then chief of the Atomic Physics Division, was encouraged by Karl Kessler, chief of the division's Spectroscopy Section, to hire Robert P. Madden, a young spectroscopist trained at Johns Hopkins and then working at the Engineering Research and Development Laboratories, Fort Belvoir, Virginia, to form a new Far Ultraviolet Physics Section, with the charge to develop radiation standards in the far ultraviolet spectral region and instrumentation for the study of this region. He arrived in 1961 on the same day and at the same hour as another young spectroscopist, Keith Codling from Imperial College, London, who had already published some related work. A short time later their collaboration would make the

---

<sup>250</sup> Robert P. Madden, private communication.

<sup>251</sup> F. R. Elder, R. V. Langmuir, and H. C. Pollock, "Radiation from Electrons Accelerated in a Synchrotron," *Physical Review* 74 (1948): 52-56; D. H. Tomboulion and P. L. Hartman, "Spectral and Angular Distribution of Ultraviolet Radiation from the 300-Mev Cornell Synchrotron," *Physical Review* 102 (1956): 1423-1447. The latter paper gives a full list of references on the theoretical work.



The very short wavelength ultraviolet radiation from the NBS 180 MeV synchrotron was utilized as a source of photons in the energy range from 5 eV to 165 eV. These photons interacted with the samples under study to give scientists previously unavailable information on the atomic structures of these substances. Robert P. Madden (left) adjusted the automatic pressure controller on advice from Keith Codling, who read the pressure gage that connected directly with the interaction chamber. After the pressure had reached equilibrium, the synchrotron was operated remotely. At upper right under the dark cover was the 3 m vacuum spectrograph specially constructed at the Bureau for these studies.

two of them famous. The two worked together from the start until five years later when Codling, his visa having expired and not wanting to apply for U.S. citizenship, returned to England.

They began by studying their instrument. A tangent section had already been attached to the glass "doughnut" of the synchrotron by the Bureau's high-energy physics staff to sample the radiation. To this Madden and Codling attached first a photometer for studying the radiation, and later a grating spectrograph for spectroscopic work, and thus was born SURF I (Synchrotron Ultraviolet Radiation Facility). In operation the synchrotron vibrated horribly, and this drove them to design and construct a special spectrograph to obtain high resolution in this mechanically hostile

environment. The spectrograph was aligned and worked perfectly after a focal adjustment of only a thousandth of an inch. The usable radiation range extended down to 10 nm.<sup>252</sup>

Madden and Codling chose first to study the absorption spectrum of helium. But they were not acting willy-nilly. There were results from electron-impact studies which indicated that the helium atom could be excited to an energy far above the single-electron-ionization energy, which meant that both electrons were excited. This state could then "autoionize" by losing one of the electrons into the ionization continuum, with the lifetime of the state determined by the strength of the interaction between the doubly excited state and the continuum.<sup>253</sup> Two-electron states of this type had been considered by theorists, but they had never been studied by absorption spectroscopy in the noble gases.<sup>254</sup> Knowing that they were entering unexplored territory, Madden and Codling consulted with Bureau theoreticians, and received mild encouragement. The doubly excited resonance had already been detected by electron spectroscopy, but its shape would be better determined with the higher resolution of the absorption experiment. It would be a nice experiment, and some higher members of the series might also be observed.

So Madden and Codling continued and carried out the experiments.<sup>255</sup> The results were shocking. While theory predicted two series of absorption lines, only one was seen.<sup>256</sup> This led to an exciting and intensive period, with the theorists and experimentalists in continuous interaction at seminars, luncheons, and ad hoc meetings. The work was extended to other noble gases: neon, argon, and later krypton and xenon, where two-electron and subshell single-electron excitations were discovered. The proliferation and visibility of the two-electron resonances were a surprise to all. The Electron Physics Section, under the leadership of John Simpson, began electron-impact studies, and found many optically forbidden transitions in all these noble gases.<sup>257</sup> New results

---

<sup>252</sup> K. Codling and R. P. Madden, "Characteristics of the 'Synchrotron Light' from the NBS 180-MeV Machine," *Journal of Applied Physics* 36 (1965): 380-387; R. P. Madden, D. L. Ederer, and K. Codling, "Instrumental Aspects of Synchrotron XUV Spectroscopy," *Applied Optics* 6 (1967): 31-38.

<sup>253</sup> R. Whiddington and H. Priestley, "Note on a New Transition Produced by Electron Impact in Helium," *Proceedings of the Royal Society of London, Series A* 145 (1934): 462-464.

<sup>254</sup> Early on, Ugo Fano studied the spectrum of the noble gases near the ionization limit: Ugo Fano, "Sullo Spettro di Assorbimento dei Gas Nobili Presso il Limite Dello Spettro D'arco," *Nuovo Cimento, Nuova Serie* 12 (1935): 154-161. Fano further studied the problem in 1961: "Effects of Configuration Interaction on Intensities and Phase Shifts," *Physical Review* 124 (1961): 1866-1878.

<sup>255</sup> R. P. Madden and K. Codling, "New Autoionizing Atomic Energy Levels in He, Ne, and Ar," *Physical Review Letters* 10 (1963): 516-518. A companion paper by the Bureau theorists J. W. Cooper, U. Fano, and F. Prats, "Classification of Two-Electron Excitation Levels of Helium," *Physical Review Letters* 10 (1963): 518-521, appears adjacent to the Madden-Codling paper.

<sup>256</sup> Actually the lines were resonances, as indeed they were expected to be.

<sup>257</sup> J. A. Simpson, S. R. Mielczarek, and J. Cooper, "Observation of Optically Forbidden Transitions in the Continuum of the Rare Gases by Electron Energy Loss Measurements," *Journal of the Optical Society of America* 54 (1964): 269-270.

seemed to be coming forth daily. In due course, the observations were explained theoretically,<sup>258</sup> but they remained so startling that they were still questioned good naturedly at meetings and symposia.

What had been discovered was a new series of interaction mechanisms between the noble gases, radiation, and free electrons, later including the process inverse to autoionization, or dielectronic recombination. Clearly these results were of considerable interest in astrophysics, for these new processes had to be taken into account in any stellar models that involved the interaction of atoms, ions, radiation, and electrons. Equally important, this synchrotron was the first to use synchrotron radiation for experimental purposes on a regular basis. The Nation now has, in addition, synchrotron radiation facilities at the Brookhaven National Laboratory, Stanford University, the University of Wisconsin, Cornell University, Louisiana State University, and Lawrence Berkeley Laboratory, and a large electron storage ring at Argonne National Laboratory. There are also many facilities around the world. Moreover, the technology of using synchrotron radiation in the soft x-ray region (0.8 nm to 4 nm) for lithography in the production of ultra-large-scale integrated circuits is on the verge of becoming commercial.<sup>259</sup> The Bureau work was a successful pioneering effort that proved the usefulness of synchrotron radiation for research.

The synchrotron SURF I was converted into a 240 MeV storage ring, called SURF II, in 1974. Subsequently its electron energy was increased to 300 MeV and with over 300 mA of injected current, SURF II remains a useful source for far UV physics and radiometry.

\*\*\*

One of the division's major programs was carried out in its Electron Physics Section under John A. Simpson. With the ostensible aim of doing everything with electrons that could be done with light, the section's work to achieve that aim led it into new and interesting directions. The program was many-faceted. It involved polarization studies, with attempts to generate polarized beams by photo-emission from magnetic materials; elastic and inelastic scattering from both solids and gases—a

---

<sup>258</sup> While we cannot enter too greatly into details, the lines formed a series, with the lowest member being the state  $2s2p$ . This state is degenerate with  $2p2s$ . The series converges to the  $n=2$  level of  $\text{He}^+$ . However, the probability of excitation to  $2skp$  or  $2pks$ , where  $k$  is a running integer, was expected to be about the same, and thus two separate series were expected. But since only one was observed, it was clear that  $2skp$  or  $2pks$  were not an appropriate classification of the lines of the series. Now, these states are nearly degenerate, and, with electron-electron interaction sufficiently strong, the wave function should be  $[u(2skp) \pm u(2pks)]/\sqrt{2}$ . Further analysis showed that the + wave function should be the more dominant. Indeed, in due course Madden and Codling were able to find the very weak lines corresponding to the minus sign. Since excitations to  $2pkd$  for  $k=3$  and above are also allowed by the selection rules, a third mixed series was also expected. This series has subsequently been observed and, as predicted, is very much weaker than the negative series. (M. Domke, G. Remmers, and G. Kaindl, "Observations of the  $(2p, nd)^1P^0$  Double-Excitation Rydberg Series of Helium," *Physical Review Letters* 69 (1992): 1171-1174)

<sup>259</sup> "Industry Gambles on Electron Synchrotrons for X-Ray Lithography," *Physics Today* 44(10) (October 1991): 17-21.

continuing activity; and an improved way of studying multiple scattering events by measurement of total energy loss. This last-named technique permitted the calculation of the mean free path of the electron within a few percent. And a study of scattering from aluminum showed that the angular distribution of the scattered electrons was independent of the thickness of the scattering foil, indicating a type of diffraction. This result supported a theory of electron scattering proposed by Gregor Wentzel at the University of Munich in 1921. Inelastic scattering in the same material proceeded by multiple collisions of a type involving long-range interactions with the electrons in the foil supported a model proposed by Ugo Fano in 1956.<sup>260</sup> Scattering from vapors was also studied and applied to such problems as measuring the velocity distribution in beams of metal atoms.

But the activity that was to provide exciting and unforeseen results arose from a combination of scattering from gases and instrument development. Always interested in instrument improvement, the section staff was constantly concerned with electron monochromators, electron diffraction apparatus, energy analyzers, and similar instruments. Beginning in 1961, they began a concerted study of electron optics. The payoff was quick and rewarding. From this study there developed a superb electron monochromator and energy analyzer. With electron beams monochromatic within 0.02 eV in the range 1 eV to 100 eV, it was superior to anything available elsewhere.

At the time of the analyzer's completion, the first autoionization results from the synchrotron radiation experiments were being obtained and, under Simpson's personal leadership, the instrument was immediately turned to studies of the same systems. Results were immediate, and they completely confirmed and complemented the spectroscopic work. Indeed, they had an advantage in that, with electrons, optically forbidden transitions could be observed.<sup>261</sup> In addition, a measurement of electron transmission in helium showed a sharp increase in transmission at 19.3 eV,<sup>262</sup> a window which eventually would be used for constructing another type of monochromator.<sup>263</sup> In addition, negative ion states could be observed when the instrument was operated to display total scattering cross-section. Such states—previously unknown—were found in all the rare gases, in molecular hydrogen and deuterium, and in mercury.<sup>264</sup> It was a startling discovery.

---

<sup>260</sup> U. Fano, "Atomic Theory of Electromagnetic Interactions in Dense Materials," *Physical Review* 103 (1956): 1202-1218.

<sup>261</sup> Simpson, Mielczarek, and Cooper, "Observation of Optically Forbidden Transitions."

<sup>262</sup> J. A. Simpson and U. Fano, "Classification of Resonances in the Electron Scattering Cross-Section of Ne and He," *Physical Review Letters* 11 (1963): 158-159.

<sup>263</sup> J. A. Simpson, C. E. Kuyatt, and S. R. Mielczarek, "Electron Monochromator Utilizing the Scattering Resonance in Helium," *Review of Scientific Instruments* 34 (1963): 1454-1455.

<sup>264</sup> "NBS Develops New Tool for Exploring Atomic Structure," *Technical News Bulletin* 48 (1964): 64-68.



It was a time of intense coordination among the spectroscopists, the electron people, and the theoreticians. New results seemed to come almost daily. Dozens of new—and new kinds of—energy levels were observed, studied, and classified. The Bureau had become a world center for this area of intermediate-energy physics. And in instruments, beyond synchrotron light, the Bureau had developed a new precision electron monochromator-analyzer that opened up this new field of experimental physics to the whole world.

### *Molecular Spectroscopy*

Research on molecular spectroscopy dates from the very early days of NBS when William W. Coblenz measured the infrared absorption of various chemical compounds and noted the characteristic wavelengths which provided a “fingerprint” for each. While it would take twenty-five years for the theory to be developed to the point that this characteristic spectrum could be correlated with the structure and chemical bonding in a molecule, Coblenz recognized the potential of infrared spectroscopy for identification of chemical substances. In 1945 Director Condon brought Earle K. Plyler to NBS to establish a laboratory for high-resolution infrared spectroscopy. By utilizing the new solid state infrared detectors, which were much more sensitive than the thermal detectors previously used, he built an instrument of unsurpassed resolving power. In the late 1950s he recruited younger spectroscopists, such as Arthur Maki and Walter Lafferty, who used this spectrometer to elucidate the structural details of a host of small molecules. They were also among the first to use computers for processing the voluminous data produced by high-resolution spectrometers.

In the 1955-1958 period David R. Lide built up a microwave spectroscopy laboratory, introducing to the Bureau a technique for studying pure rotational spectra of molecules. This work was initially located in the Heat Division because of its applicability to predicting thermodynamic properties. New techniques were developed for using microwave spectroscopy to study internal rotation in molecules and to characterize transient free radicals and molecules present in high-temperature vapors. The microwave and high-resolution infrared groups were merged into one section in the Atomic Physics Division in 1963. The joint application of these techniques led to significant advances in the analysis of complex molecular interactions; for example, NBS spectroscopic data were a key to understanding the early infrared gas lasers.<sup>265</sup> Other groups involved in high-resolution spectroscopy in the visible and ultraviolet regions were added later. Thus by the mid-1960s NBS had one of the world's premier molecular spectroscopy laboratories, which attracted many guest scientists from the United States and abroad for sabbaticals and postdoctoral stays.

---

<sup>265</sup> D. R. Lide and A. G. Maki, “On the Explanation of the So-Called CN Laser,” *Applied Physics Letters* 11 (1967): 62.

## Radiation Physics

The first Kelly Committee found the Radiation Physics Division (at that time combined with Atomic Physics) one of the stellar scientific organizations of the Bureau. The division maintained this position during the period of the present chapter. With activities in radiation protection, dosimetry, radioactivity standards, neutron physics, high energy radiation, x rays and gamma rays, nuclear physics, and theoretical physics, the division was nicely balanced between basic research and directly useful results. It provided Standard Reference Materials for radioactivity standards, calibrations of x-ray measuring equipment, data for radiation protection, research on dose measuring methods, and research in radiation and nuclear physics as support for all these activities and because of its fundamental importance. Four areas of work—nuclear structure, dosimetry, radioactivity standards, and theoretical studies—illustrate well the breadth of the work.

One of the constant themes of the division research program was nuclear structure, where the effort was directed at determining the size and shape of the nucleus. The single example we describe arose from the capability to align nuclear moments. This capability was exploited in the Heat Division for the parity experiment. For several years, studies of the polarizability of the nucleus, as determined by the scattering and absorption of photons, indicated that some nuclei do not have spherical symmetry but are different in three orthogonal directions, which indicated that the nuclear polarizability was a tensor quantity. To check this result, photoneutron production was studied in a single crystal of holmium ethyl sulfate, holmium being one of the elements with an asymmetric nucleus. The yield of photoneutrons was measured as a function of the crystal orientation with respect to the photon beam. At 4.2 K and above, where the nuclei are not aligned, only slight asymmetry was measured, but at 0.3 K, at which temperature the nuclei are aligned, considerably larger asymmetries were found, an indication that the nucleus indeed has a tensor polarizability. Its nuclear matter was not symmetrically distributed.

Dosimetry and the study of various ways to measure radiation dose also were continuing activities. Three main areas were covered: ionization chambers, photographic films, and solid state devices. In the ionization chamber method—the standard calibration means for x rays—a large chamber was constructed for determining the total energy transported by x-ray beams with energies between 6 MeV and 70 MeV, with an uncertainty of 2 percent. A complete description was published as NBS Monograph 48, and the calibration was transferred to laboratories in France, Germany, Switzerland, and Yugoslavia.<sup>266</sup>

Photographic dosimetry was actively pursued, concentrating on the extension and refinement of the photographic process and broadening the range of its applicability in the measurement of radiation. And in solid state dosimetry, it was shown in one investigation that it is possible to use silicon radiation cells as photodiodes for x rays, particularly at high dose rates.

---

<sup>266</sup> John S. Pruitt and Steve R. Domen, *Determination of Total X-Ray Beam Energy With a Calibrated Ionization Chamber*, Natl. Bur. Stand. (U.S.) Monograph 48; June 1962.

A unique and vigorous aspect of the division's program was the production and sale of Standard Reference Materials as radioactivity standards. Some twenty new nuclei were offered, from tritium-labelled toluene to americium-241. Featured were two re-determinations of the half life of carbon-14, with a final value of  $5745 \pm 50$  years.

The program that perhaps best illustrates the balance of basic research and applied output was that in radiation theory. As the division that first emphasized the importance of theoretical research, it always maintained a strong program in theoretical studies, with a careful balance between pure and applied research. For example, the theoretical analysis of cross sections was a continuing activity, with a study of bremsstrahlung and pair production, and a quantitative theory for calculating the polarization of gamma rays from the measured angular distribution of electron-positron pairs was developed.

Another continuing program was in the computer calculation of multiple scattering of various radiations, and hence their penetration into various media, both bounded and unbounded. Illustrating the public concern of the time, with support from the Office of Civil and Defense Mobilization and the Defense Atomic Support Agency, a study was carried out on civil-defense related shielding problems, and published as NBS Monograph 42.<sup>267</sup>

Up to 1963, the work of the division was built around nuclear physics and what might be called the "classical" fundamental particles—protons, neutrons, electrons, positrons, gamma rays and, to a lesser extent, pions, or pi mesons as they were then called. Particle physics, with its myriad of baryons and mesons, was mostly left to laboratories that had machines of sufficient energy to produce and study this bewildering (to the average scientist) array of particles. But the so-called "eight-fold way" that was developed by Murray Gell-Mann of the California Institute of Technology and Yu'val Ne'eman of Israel promised to be a system that would bring some sense of order. In the very next year, the Bureau initiated a small program in particle physics, an important step which expanded its interest beyond nuclear physics to fundamental particle physics and true high-energy. The step was apparently too big, and the new field brought only a slight connection to the Bureau's traditional measurement standards role. No experimental program was ever initiated; the program was purely theoretical and even that was haltingly supported. Thus, while other aspects of theoretical nuclear physics were pursued vigorously, particle physics was not. Yet the program lasted for almost twenty years, and during its continuance provided the Bureau with a tiny window to one of the most challenging fields of modern science.

Perhaps the most important events that occurred during the period were not scientific developments, but the procurement of two new radiation sources: a linear accelerator, or LINAC, and a nuclear reactor, both of which added a whole new dimension to the Bureau's radiation capabilities.

---

<sup>267</sup> L. V. Spencer, *Structure Shielding Against Fallout Radiation from Nuclear Weapons*, Nat. Bur. Stand. (U.S.) Monograph 42; June 1962.

## *Two New Radiation Sources*

At the House Appropriations Committee Hearings for FY 1960, Astin announced to the committee that he had formed a nuclear reactor study group in late FY 1958 to “undertake initial planning for an NBS research reactor.”<sup>268</sup> The group was surveying the NBS present and future programs and external scientific organizations as to their needs for a research reactor. The areas of study were already known to be neutron standards and dosimetry at high flux levels, development of activation analysis as a basic and highly sensitive tool in analytical chemistry, neutron diffraction, particularly in magnetic and organic materials, and neutron irradiation to produce short-lived isotopes.

In fact, by the time Astin presented this plan, the decision had essentially been made to proceed with a nuclear reactor facility. In a long 1957 memorandum to Astin, Nicholas Golovin had proposed the formation of a group to “launch the reactor program,”<sup>269</sup> and Bureau management decided to accept this proposal. It was an unusual decision. There was no strong clamor for such a facility from the Bureau staff, as would normally be expected,<sup>270</sup> but this was ascribed to the lack of a facility. If staff enthusiasm were to be used as a criterion for the facility, support was not likely, and would not be found until the facility existed. It was a chicken-and-egg problem. To correct this situation, Golovin recommended that, during the planning and construction phase of the reactor facility, appropriate NBS staff work at other institutions, such as the Argonne National Laboratory, to begin an NBS research program. Carl O. Muehlhause, a nuclear physicist with reactor and research experience at both the Argonne and Brookhaven National Laboratories, was hired in 1958 to head the group that Golovin had proposed. Muehlhause was assigned to the Director’s Office. Thus, reminiscent of the way Astin made the decision to acquire the large testing machine, Bureau management made the decision to obtain a nuclear reactor facility despite the absence of enthusiastic support from the Bureau staff. It proved to be a wise decision.<sup>271</sup>

At the FY 1961 hearings, Astin asked for \$700 000 for design work for the reactor, and in 1962 a further \$8.15 million for construction of the reactor building and the reactor itself.<sup>272</sup> The reactor was meant to be used by the whole Washington scientific community. In fact, users were to come from much farther away. The reactor was

<sup>268</sup> House Committee on Appropriations, Subcommittee on Department of Commerce and Related Agencies, *Department of Commerce and Related Agencies Appropriations for 1960: Hearings Before a Subcommittee of the Committee on Appropriations, House of Representatives*, 86th Cong., 1st sess., National Bureau of Standards, 1 May 1959: 305.

<sup>269</sup> Memorandum, N. E. Golovin to A. V. Astin, “NBS Requirements and Plans for a Nuclear Research Reactor,” July 8, 1957. (NARA; RG167; Astin file; Box 18; Folder Reactor Accelerator)

<sup>270</sup> *Ibid.*; also Memorandum, I. C. Schoonover to A. V. Astin, “NBS Reactor,” February 13, 1958. (NARA; RG 167; Astin File; Box 18; Folder Reactor Accelerator)

<sup>271</sup> This was not the first time the Bureau considered a nuclear reactor. In 1946, during Condon’s tenure as director, there was a “Proposal for a National Radiation Institute of the NIH and the NBS.” (NARA; RG167; Directors file; Box 16; Folder NIH-NBS (Project on Atomic Pile)). Nothing came of it.

<sup>272</sup> Appropriations Hearings for 1961: 238; Appropriations Hearings for 1962: 828-829.

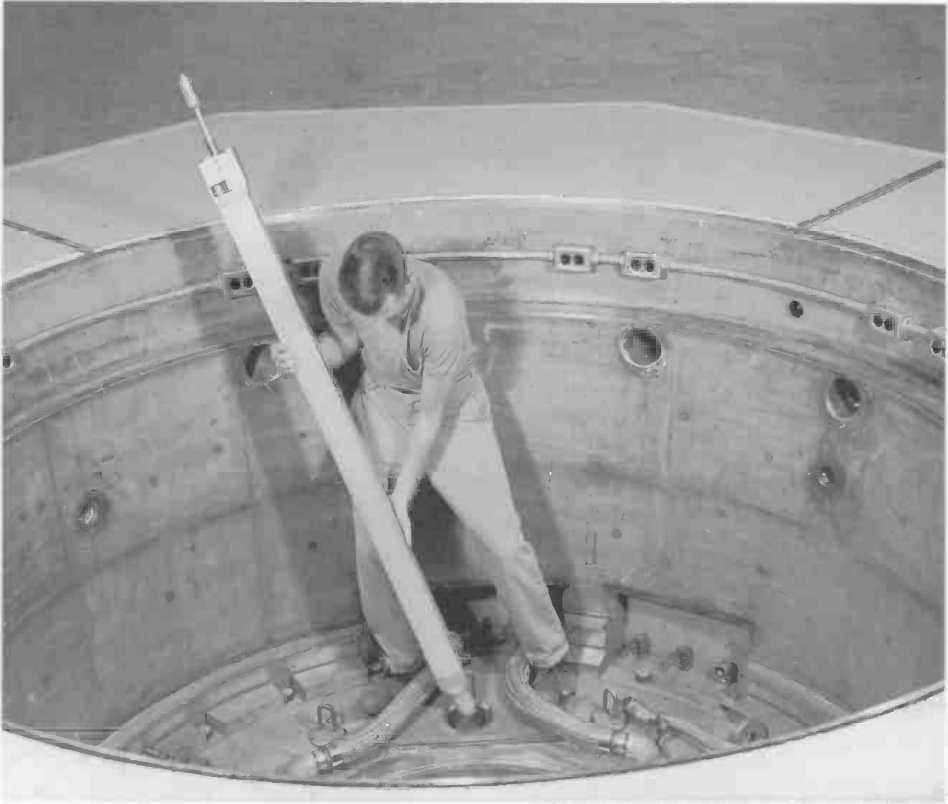

Charles Ware inserted a fuel element containing uranium-235 into the loading port of the NBS 10 MW nuclear reactor just before it became operational (1966).

designed by Muehlhouse, Robert S. Carter, and Harry H. Landon, a small group compared to the huge teams used to design reactors in later years. Building construction began in 1963 and was completed in 1966. The reactor achieved criticality December 7, 1967. The Bureau had a new radiation source.

There had been considerable discussion about the type of reactor that should be built, specifically on its size. In an analysis of this question, Randall S. Caswell came to the conclusion that the reactor should be either a small machine that would provide only a few irradiations, but quite cheap, or a large, "really first rate reactor."<sup>273</sup> An intermediate size reactor would be neither fish nor fowl, and there would be difficulty in supporting a solid research program. He estimated that a large reactor with a flux of  $10^{14}$  neutrons/cm<sup>2</sup> · s would cost about \$10 million and require a crew of perhaps

<sup>273</sup> Memorandum, R. S. Caswell to L. S. Taylor, "Nuclear Reactor Planning," March 5, 1957. (NARA; RG 167; Astin file; Box 18; Folder Reactor Accelerator)

fifteen persons. Bureau management readily opted for the large, deluxe reactor.<sup>274</sup> They selected a 10 megawatt machine with a flux of  $1.7 \times 10^{14}$  neutrons/cm<sup>2</sup> · s, almost twice Caswell's planning criterion. Its fuel, enriched uranium-235 and uranium-238, was alloyed with aluminum and then clad with aluminum to prevent contamination of the coolant. The moderator was heavy water. Cooling water flowed at the rate of 19 m<sup>3</sup>/min. Thirteen beam tubes, or ports, running from the heavily shielded reactor core transported the neutrons to the working areas for experimental purposes. In addition, there were facilities for in-pile radiation studies. A space was also provided for a "cold source," in which neutrons could be cooled to cryogenic temperatures. Such a source would be added in the late 1980s, putting the Bureau at the forefront of the use of neutrons for experimental studies. The total cost at the time of construction was somewhat over \$9 million, very close to Caswell's prophetic \$10 million estimate.

In 1970 the reactor had its first refueling. By that time four neutron spectrometers were in operation for crystal and liquid structure work, and a time-of-flight instrument for inelastic scattering. Under development were a triple-axis spectrometer for crystal dynamics studies, and a high-resolution cold neutron facility, which was not completed until 1990, by which time the reactor power had been doubled to 20 MW. Bureau studies in 1970 were concerned with ternary fission in uranium-235 and plutonium-239  $\alpha$ -accompanied fission. A technique for neutron-flux measurements using boron-10 and cobalt as absorbers was under development. The facilities were used extensively for activation analysis, hydrogen-bonding studies in crystals, and phase transitions in long chain hydrocarbons. There were collaborative programs with other agencies, notably with Los Alamos for the calibration of a uranium-235 fission neutron source. Local agencies, such as the Naval Ordnance Laboratory and the Naval Research Laboratory, carried out structure determinations on a variety of magnetic materials and amorphous silica. An extensive activation analysis program was being initiated, and considerable work was being performed in collaboration with university scientists in solid state and nuclear physics studies.

There was never any doubt about enthusiastic staff support for a linear electron accelerator, or "LINAC," for short. Such a machine was a natural outgrowth of the Bureau's high-energy physics program, in which the main available machines were the 50 MeV betatron and the 180 MeV synchrotron. But there were other reasons for wanting a LINAC. Near the end of the 1959 appropriations hearings, where much of the discussion had been on high temperatures, the following exchange took place:

---

<sup>274</sup> "High-Flux Research Reactor for New NBS Site," *Technical News Bulletin* 45 (1961): 127-128; "Work Begun on NBS Reactor Buildings," *Technical News Bulletin* 47 (1963): 154-155; "NBS Completes High-Flux Reactor," *Technical News Bulletin* 50 (1966): 212-214; "NBS Reactor Achieves Criticality," *Technical News Bulletin* 52 (1968): 50; "Research at NBS Reactor," *Technical News Bulletin* 54 (1970): 174-176.

MR. YATES: Are there other such fields that you think we should know about?

DR. ASTIN: Yes there are. Actually, in the things I submitted to the Secretary, the high temperature studies were third priority. My first priority was high intensity radiation-producing devices which we need for precise measurements in the nuclear and atomic radiation field.

MR. FLOOD: Off the record.

The remainder of the discussion is not available, but upon coming back on the record, the discussion continued:

MR. YATES: With what you have asked for—and apparently you will get—with \$1.5 million can you . . . make an . . . attack upon the problems you refer to in your justifications as your basic research program?

DR. ASTIN: Yes.

MR. YATES: I would like the record to show that that would be earmarked and pigeonholed and nailed down as a line item, if necessary, despite what the glorified clerks masquerading under three stars might have to say.<sup>275</sup>

The line item was the LINAC. Clearly, along with its own specific needs, there were classified military reasons for NBS to obtain such a machine, and it was being awarded \$1.5 million to get the process started. Thus, when funds were appropriated in September 1958, the staff of the High Energy Radiation Section began a study on the proposed new instrument.<sup>276</sup> The purpose of the study was "the examination of the Bureau's responsibilities in research areas made possible by recent accelerator developments, the specification of a research program, and accelerator and a building design."

The principal difference between the proposed accelerator and the Bureau's existing machines was beam power, not particle energy. Recent advances in accelerator technology had made possible beam powers of 10 MW at electron energies of 10 MeV and, the report states, these were being investigated commercially for the sterilization of pharmaceuticals and foods, for the polymerization of polymers and the vulcanization of rubber, and the curing of tobacco. The Bureau program would provide the scientific basis for this emerging technology. However, these applications would probably "not be studied directly by NBS," but "the assembly of basic data and measurement techniques that make such applications possible would be the goal."

None of this could be achieved with the Bureau's existing accelerators. The power output of the 50 MeV betatron was 20 mW, and for the 180 MeV synchrotron it was 100 mW. Commercial practice was absolutely impossible with such low beam-power machines. Thus what the Bureau proposed was a linear accelerator which, operating at an electron energy of 40 MeV would produce a 40 kW beam. This represented an increase in power by a factor of about 100 000. And not only would the instrument produce the primary electron beam, x rays, positrons, and neutrons could be produced with the beam impinging on various targets.

<sup>275</sup> Appropriations Hearings for 1959: 440.

<sup>276</sup> "A Proposal for a High-Intensity Electron Accelerator," NBS Report 6555 (June 1959).

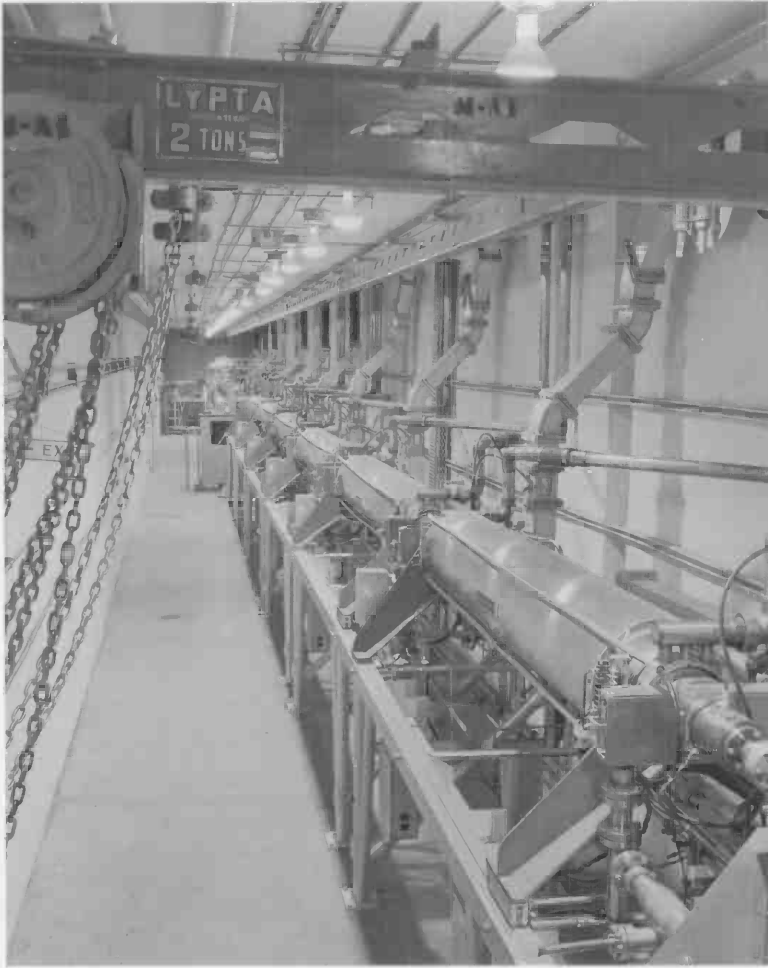

Electrons were accelerated through LINAC's 100 ft nine-section pipe at a speed that approached the speed of light. In the gap after the third section, the electron beam could be changed to a positron beam by means of a target interaction. The LINAC could generate a 100 MeV electron beam.

The research would involve studies in nuclear and atomic physics, and the development of dosimetry standards and measurement techniques. The reason for the high beam power requirement in nuclear physics was that some of the processes of interest occur very infrequently, and some experiments, if possible at all on the betatron and synchrotron, would require months of exposure time, whereas they could be done in a few hours with the proposed instrument. And the presence of the other radiations permitted studies not possible at all with the older instruments.





In 1966, the Bureau's powerful linear accelerator (LINAC) went into operation. It was located entirely underground in a wing that projected from the Radiation Physics Laboratory at the NBS site near Gaithersburg, Maryland.

Dosimetry standards, always a major part of the Bureau's responsibilities in the radiation field, were carried out at relatively low radiation doses on the order of 100 rad, and dose rates of thousands of rad per hour. But new advances required standards at much higher dose rates for nuclear research, personnel protection, and science and industry generally. Indeed, the military projected a need for standards in the 10 billion rad range. Related to dosimetry were shielding studies on such materials as concrete and lead, and control methods for such intense beams. The addition of the proposed LINAC to the Bureau's array of other radiation sources—cobalt, radium, x-ray, and electron beam devices—would give the Bureau an impressive array of tools for such studies.

Funds were appropriated for the construction and the High Voltage Engineering Corporation built the LINAC using detailed specifications developed by the study group. What resulted was a linear accelerator that produced a beam of 150 MeV electrons at low beam power, and 100 MeV electrons at a beam power of 50 kW. It consisted of nine 10 ft sections of waveguide powered by radar klystrons operating at a frequency of 1.3 GHz. This accelerator delivered a 2 mm diameter beam to a beam-control room where iron magnets directed it to any of three 45 ft × 35 ft experimental

rooms. For personnel protection, the whole assembly was 32 ft underground, and the experimental rooms were separated from one another by 12 ft of concrete. Along with all the other Bureau radiation research devices (except, of course, the reactor), it was housed in a special building on the Gaithersburg site.

The LINAC was accepted from the contractor on October 7, 1965. It had always been planned that it would be used by the whole scientific community, and a preliminary meeting of LINAC users was held on October 11, 1965.<sup>277</sup> The Bureau had a new high energy radiation source.

## Chemistry

A comparison of the annual reports on chemistry in 1964 with those in 1958 shows both continuity and striking changes. This development was only partly occasioned by the 1961 reorganization which split the original Chemistry Division into two: one called Analytical and Inorganic Chemistry (the "Inorganic" was dropped at the 1964 reorganization into Institutes) and the other, Physical Chemistry. At the same time, all organic coating work was stopped and the Electrodeposition Section was transferred to the Metallurgy Division.

The changes went much further than simple changes in the organization chart. During the seven years of the period, there were many substantive changes. Consider first the Analytical Chemistry Division. Where it previously had ten sections, it was now left with five: Pure Substances, Spectrochemistry, Solution Chemistry, Standard Reference Materials, and Applied Analytical Research.

In 1958 the Annual Report lists the following topics as being investigated during the year:

- Analysis of small amounts of tungsten in steel.
- Use of flame photometry for the determination of sodium, potassium, calcium, and strontium in the presence of other alkali and alkaline-earth ions.
- Purification of titanium halides.
- Automatically controlled equipment for the evaluation of purity.
- Simultaneous spectroscopic determination of eighteen elements.
- Development of an integrating electrochemical coulometer.
- Synthesis of tritium-labeled carbohydrates.
- Preparation of a series of oil-soluble metal analytical standards to be used in assessing engine wear.
- Experimental and theoretical studies of boron compounds as potential high-energy fuels for rocketry.
- Development of an apparatus for the controlled sublimation and separation of substances at very low temperatures, potentially useful for free radicals.
- Instrument for estimating night vision.

---

<sup>277</sup> *Radiation Physics Division Information Handbook*, February 1, 1965. A copy of the handbook was provided to the attendees of this meeting. It contains NBS Report 6555 and is the source for most of the material used in this section.

- The use of a plasma jet for the analysis of an alloy.
- Spectrometric identification of trace constituents in complicated gas mixtures such as smog.<sup>278</sup>

By contrast, the 1964 Annual Report listing for the Analytical Chemistry Division reads:

- Activation analysis improved.
- Improved Mössbauer spectrometer.
- Radioisotopic tracers used for analysis.
- Clean room constructed.
- Spark source mass spectrograph acquired.
- Single reproducible pulse obtained with laser microprobe.
- X-ray spectrographic analysis of solutions.
- Electron probe microanalyzer extends capabilities.
- Spectra excited in controlled atmospheres.
- Special cast iron standards prepared for the Malleable Research Foundation.
- Errors in the microscopical measurement of spheres studied.
- Thermodynamics of solutions in heavy water.
- pH standards in partially aqueous media investigated.
- Preconcentration polarography.
- Magnetic densimeter constructed.
- Copper-base and white iron standards issued.
- New uranium and plutonium isotopic standards issued.
- High-precision coulometry.
- Analysis and purification services provided.<sup>279</sup>

A short perusal of these lists shows that in both years the division was working in its traditional areas of the analysis of metal alloys and the provision of standard materials, the production of pure materials and the development of methods of assessing purity, and the development of analytical methods. In 1964, however, the focus was a little sharper, the emphasis had changed, and totally new items appeared. Activation analysis, spurred by the forthcoming nuclear reactor, was a new area. Trace analysis, arising from the division's history in evaluation of purity, had a whole new clean room constructed for its study. But perhaps most striking was the number of new, sophisticated, and costly instruments: a spark source mass spectrometer, a laser microprobe, an electron microprobe, and a Mössbauer spectrometer. This was part of a concerted effort, announced in 1961, to increase emphasis on instrumental methods of analysis. In that year alone seven major pieces of analytical apparatus were purchased. These new trends would continue. Under the aggressive leadership of its new chief, W. Wayne Meinke, the Analytical Chemistry Division would become a world leader in activation, trace, and instrumental analysis.

<sup>278</sup> Annual Report, 1958: 35-39.

<sup>279</sup> Annual Report, 1964: vi, 125-131.

It is nearly impossible to make the same kind of comparison between the 1964 Physical Chemistry Division and what existed earlier. Four of its seven sections were led by, and consisted of pieces of, sections other than the original Chemistry Division.<sup>280</sup> It was as if Bureau management had taken some of its best people in physical chemistry and related areas and thrown them together. The Annual Report for 1962 gives a good summary of the research. With the stated aim "to develop an understanding of the molecular basis of bulk properties and macroscopic processes," the division carried out an extensive set of "studies on synthesis of labeled carbohydrates, isotope effects, and conformations of sugars; spectroscopic determinations of structural constants of free radicals and simple organic molecules; analysis of elementary processes in flames; investigations of radiolysis and vacuum ultraviolet photolysis of organic molecules; precise measurements of heats of reaction and formation; studies of chemical reactions and ionization processes at crystal surfaces; determinations of atomic weights; and measurements of nuclear spin-spin interactions."<sup>281</sup>

Cognizant of the need for reference data, in 1962 the division was actively setting up a document retrieval system for physico-chemical data, and in 1963 undertook a complete revision of Circular 500, *Selected Values of Chemical Thermodynamic Properties*.<sup>282</sup> Groups were also established to compile and evaluate data on gas-phase chemical kinetics and ionization energies (appearance potentials) of molecules. The division would eventually have four data centers in the NSRDS, and become a world leader in the dissemination of thermodynamic and other physico-chemical data.

## Materials

The three materials divisions—Inorganic Solids, Polymers, and Metallurgy—all showed significant changes in the character of the work performed during the period. Indeed, a few years later the Annual Report was to declare, "Even in specifically technological areas such as glass, paper, ceramics, metallurgy, and corrosion, NBS programs have changed in the last few years from a craft orientation to a science-based orientation. As a result, the output of data, standards, and methodology have much

<sup>280</sup> Specifically, Ralph Klein came from the Electron Physics Section of Atomic and Radiation Physics to head the Surface Chemistry Section, along with Vernon H. Dibeler and his Mass Spectrometry Section. From the Heat Division's Free Radical Program came Robert E. Ferguson to head the Molecular Kinetics Section, along with David E. Mann and his Molecular Spectroscopy Section. The able theorist Robert W. Zwanzig from Heat's Statistical Physics Section came into the Office of the Chief of Physical Chemistry. Thermochemistry under Edward J. Prosen, Organic Chemistry under Horace S. Isbell, and Molecular Structure and Properties of Gases came from the Chemistry Division, as did Merrill B. Wallenstein, the chief of the new Physical Chemistry Division.

<sup>281</sup> Annual Report, 1962: 84-85.

<sup>282</sup> Frederick D. Rossini, Donald D. Wagman, William H. Evans, Samuel Levine, and Irving Jaffe, *Selected Values of Chemical Thermodynamic Properties*, Natl. Bur. Stand. (U.S.) Circular 500; February 1952. W. Reeves Tilley, chief of the Office of Technical Publications, relates that Circular 500 was so important that after it was out of print and no longer available, an industry official asked Tilley to "name your own price" for a copy.



Hideo Okabe prepared equipment prior to the photolysis of deuterated ethane.

greater precision, meaning and usefulness."<sup>283</sup> By the end of 1964, this transformation was largely complete, although it was more evident in the Polymers Division than in the other two.

There was no revolutionary change in the program of the Inorganic Solids Division (named the Mineral Products Division until 1962) but, as indicated by the transfer of the Concreting Materials Section to the Building Technology Division, management wanted the work to become more basic. The division would no longer have the responsibility for the huge cement testing activity, and the cement and concrete supporting research would henceforth be done in Building Technology. But, while there was no

<sup>283</sup> Annual Report, 1967: 5.

revolutionary change, there were an increasing number of examples of basic research carried out during the period. There was, first of all, the diamond anvil (produced, incidentally, with little or no encouragement from management) and its use to study the effect of pressure on the infrared spectra of solids, and in pressure-induced phase transformations. Other noteworthy efforts were:

- The direct observation of dislocations in ceramics by transmission electron microscopy, now common and routine, but at that time an exciting new development, especially for ceramics.
- The new analysis of experimental data which showed that configurational entropy is a criterion for glass transformation.
- The study of single crystals, including methane as the simplest solid that shows a phase change; crystals of the rare gases, because they are the simplest solids known; and a program supported by ARPA on the methods of growth of crystals of inorganic materials.
- The theoretical development of a computer-generated "random-network" model to get at the "statistical topology and geometry" of such materials as silica glass and water.<sup>284</sup>
- The production of glasses of unique morphology by bringing to critical opalescence glass compositions that show liquid-liquid separation, followed by rapid quenching, forming a random two-phase solid with both phases interconnected.

Unquestionably the most elegant scientific development resulted from a study of internal friction by John B. Wachtman, who would, in 1968, become chief of the Inorganic Materials Division. In a material demonstrating this phenomenon, the application of a sinusoidal stress (or strain) results in a sinusoidal strain (or stress) response that is out of phase with the applied excitation. This behavior results from the fact that some mechanical energy is converted to heat, hence the friction in the name. Similar behavior is exhibited by dielectrics excited by a time-varying electric field, and the behavior is generally undesirable.

For some materials, measurement of the internal friction over a wide temperature range at a constant frequency indicates a characteristic peak in the internal friction at a specific temperature, with this temperature being higher the higher the frequency of the excitation. In such materials, a relaxation time for the molecular process responsible for the internal friction may be defined as the reciprocal of the frequency at the peak. Numerous experiments show that the relationship between the temperature of the peak and the relaxation time follows an Arrhenius relationship, suggesting that whatever the molecular process, it is an activated one. The question in any given situation is, "What specifically is the molecular process?"

---

<sup>284</sup> Annual Report, 1963: 104.

Wachtman carried out a complete series of experiments on thorium oxide containing 1.5 percent calcium oxide, a system that shows an easily observable internal friction peak. Now, in this material, the calcium ion replaces a thorium ion substitutionally, and because it has only one oxygen compared to thorium's two, an oxygen vacancy must perforce exist around the calcium ion. Indeed, there are eight lattice sites the vacancy can occupy. Without going into more detail, we can state that Wachtman showed that the molecular process responsible for the internal friction was the stress- or electric field-induced motion of oxygen vacancies from one site to another.<sup>285</sup> Since in this movement the vacancy has to surmount an energy barrier, this is the necessary activated process. He was able to show that the process occurred with a single relaxation time. In effect, the application of stress or an electric field changed the population distribution of vacancies between sites, and when the frequency of the rearrangement equalled the applied frequency of the applied excitation, a peak in the internal friction occurred.<sup>286</sup>

As thorough as these investigations were, they did not answer the general question, "What is necessary in a crystal containing defects for it to show internal friction?" In a series of papers, Wachtman and his associate H. Steffen Peiser were able to give a broadly applicable answer to this question.<sup>287</sup> They considered a perfect crystal and asked what would happen to the symmetry of various sites in the crystal upon the application of a homogeneous strain, and what would happen if a point defect were placed at these various sites. If such a defect were placed at either of two positions which were equivalent before straining, and were still equivalent in the strained crystal, no internal friction would result. If, upon straining, the two sites were no longer equivalent, then internal friction would at least be possible, for then it could be advantageous for the defect to jump from one position to the other, thereby changing the distribution of vacancies. It is possible, of course, that internal friction might not be seen because its magnitude might be too small. What had been derived was a necessary condition, not a sufficient one.

From this simple, almost self-evident consideration of the change of symmetry of perfect crystals on straining came a set of rules for the occurrence of internal friction, and in a number of publications all 232 space groups were analyzed. The geometry, if not the physics, of the requirements for internal friction was firmly established.

The Organic and Fibrous Materials Division (to become simply the Polymers Division in 1962) began to change its emphasis from products formed from natural polymers (cotton, wool, silk, cellulose, natural rubber) to synthetic polymers. This trend continued so that by 1964 the principal focus of the division was on synthetic

---

<sup>285</sup> J. B. Wachtman, Jr., "Mechanical and Electrical Relaxation in ThO<sub>2</sub> Containing CaO," *Physical Review* 131 (1963): 517- 527.

<sup>286</sup> The relaxation time for dielectric relaxation was predicted—and found—to be twice the value of the mechanical relaxation time because only half the relaxation modes are operative.

<sup>287</sup> J. B. Wachtman, Jr., and H. S. Peiser, "Symmetry Conditions for Internal Friction Caused by Jumping of Point Defects in Crystals," *Applied Physics Letters* 1 (1962): 20-22.

polymers. The actual research directions were toward crystallization phenomena, solution properties as background research for the preparation of two badly needed molecular-weight standards, adsorption and the study of polymers at surfaces, and the degradation of polymers.

As already mentioned in the discussion of the Electricity Division, polymer science was revolutionized by the discovery that lamellar single crystals of polymers could be grown, and by evidence that such single crystals, along with an amorphous component, could exist in the solid state of those polymers that had the necessary regularity to crystallize at all. In the division program, these facts were used in attempting an explanation of bulk properties, led to studies of the kinetics of crystallization, and undergirded the study of single crystal forms and habits of different polymers. For example, studies were carried out on the internal friction of polypropylene, as the degree and character of the crystallinity were systematically changed. A study of the lattice spacings in crystallization of copolymers showed that segments of the minority component were incorporated in crystals of the majority component, a result that was hotly contested at the time.<sup>288</sup> A comprehensive study of the crystallization of polypropylene from solution led to the determination of exceptional crystal growth propagation characteristics exhibited by this polymer that were still the object of considerable research long after the Bureau had stopped working on them.<sup>289</sup> Of course, the Polymers Division scientists were in constant contact with the work going on in the Electricity Division.

In the area of Standard Reference Materials, the effort was devoted to the provision of standards for molecular weight—aside from chemical composition, the single most important property of polymers. Because synthetic polymers are mixtures of molecules of different lengths, their molecular weights are only averages, and for a fuller material specification, not only must the molecular weight be specified, the distribution of molecular weights must be given as well. There are three principal methods for the determination of polymer molecular weights, all of them based on the behavior of polymers in solution: the determination of the concentration distribution of a polymer solution in the enormous gravity forces obtained in an ultracentrifuge, the scattering of light by polymer molecules in solution, and the osmotic pressure of polymer solutions. Each of these methods can be analyzed from first principles and yield scientifically accurate results (when performed properly). The problem is that they are exceedingly tedious to carry out. Practically all molecular weight determinations in industry are made via the viscosity of polymer solutions, which is an easy and rapid measurement, but one with only an empirical relationship to molecular weight. Because of this state of affairs, industry had long requested that the Bureau provide a Standard Reference Material that could be used to calibrate these viscosity methods. Thus, in 1957 an ultracentrifuge was obtained and studies in sedimentation equilibrium were begun, along

---

<sup>288</sup> J. P. Colson, R. K. Eby, "Melting Temperatures of Copolymers," *Journal of Applied Physics* 37 (1966): 3511-3514.

<sup>289</sup> F. Khoury, "The Spherulitic Crystallization of Isotactic Polypropylene From Solution: On the Evolution of Monoclinic Spherulites From Dendritic Chain-Folded Crystal Precursors," *Journal of Research of the National Bureau of Standards* 70A (1966): 29-61.



with studies in light scattering and osmotic pressure. By 1964, two polystyrene SRMs were available, one with a narrow molecular weight distribution, and another with moderately broad distribution, and with average molecular weights of 180 000 and 217 000 respectively. In later years, with advances in gel-permeation chromatography, samples with certified molecular weight distributions would be offered.

In a different area, with support from the Navy Bureau of Aeronautics, and spurred by the concern for the adhesion between glass fibers and the matrix in polymer-glass composites, the division in 1958 began a study of the adsorption of polymer molecules from solution. The results indicated that far more polymer was absorbed than could be explained by the polymer molecules lying flat on the surface. This result could be explained if polymer segments separated by bridges of dangling polymer chains were the units adsorbed. In effect, this meant that a solvent-swollen film of polymer lay on the surface, and the study of this film became important. To carry out this study, an instrument called an ellipsometer was obtained. The instrument measures the change in the state of polarization of light upon reflection from a surface, and from the measurement the optical constants of a film-free surface may be calculated. Further, if the optical constants of the surface are known, and if the surface is overlain by a dielectric film, the refractive index and thickness of the film can be determined—just what was needed for the polymer experiments. These did indeed show that the polymer was in the form of a swollen film, but the details of the situation depended on the polymer-surface and polymer-solvent interactions. Nevertheless the results elicited quite a bit of attention, and a significant theoretical effort supported the experiments. For a number of years, the Bureau was a world center for this type of work.

Equally important, the use of the ellipsometer was a significant part of other work. Jerome Kruger in the Metallurgy Division also used the ellipsometer in investigations on passive films in corrosion, and Theodore R. Young used it in work on the role of adsorbed films on the measuring surfaces of gage blocks used related techniques. The Bureau had become a center for such measurements, and a symposium with international participation on the use of the ellipsometer was held. The resulting proceedings volume was for many years the bible of ellipsometry for any scientist interested in the properties of surfaces.<sup>290</sup>

The program on degradation in the Organic and Fibrous Materials Division had many facets, and was mainly supported by NASA and various agencies of the DOD. The basic aim of the program was to determine the mechanisms of degradation and with this information try to synthesize more resistant polymers, or to design additives that would prevent degradation. Thermal degradation and degradation by radiation were of particular concern, the latter because of the space environment. In addition, radiation was used to try to synthesize high temperature elastomers based on fluorinated hydrocarbons.

---

<sup>290</sup> *Ellipsometry in the Measurement of Surfaces and Thin Films*, E. Passaglia, R. R. Stromberg, and J. Kruger, eds., Natl. Bur. Stand. (U.S.) Miscellaneous Publication 256; September 1964.



Jerome Kruger, metallurgist on the Bureau staff, demonstrated an ellipsometer to study corrosion reactions on the surfaces of metal single crystals. The instrument was on display during a two-day symposium on ellipsometry held at the Bureau in September 1963.

One particular study, concerned with materials for missile and rocket nose cones, illustrates one of the more practical outputs. In this study, three different groups of polymers were subjected to pyrolysis up to 1200 °C. One group consisted of highly cross-linked materials such as epoxy resins, another of polymers that develop cross-links by this temperature treatment, and a third which did not cross-link. The first two groups gave carbonaceous residues and low-molecular-weight volatile products, while the third group yielded only volatile products. The analysis of the results gave proof that the energy-absorbing capacity in thermal degradation is inversely proportional to the molecular size of the volatile products, and also demonstrated that polymers that leave a carbonaceous residue and liberate gas at elevated temperatures generally give superior ablation resistance to the heat generated by re-entry to the earth's atmosphere in missile nose cones.

If the changes that occurred in the other materials divisions could be classified as evolutionary, then the changes in the Metallurgy Division were revolutionary, as befits a division that received a quite critical report from the first Kelly Committee. Simply, the division became one based on metal physics rather than one based on traditional metallurgy. The change began in 1957 when James I. Hoffman, himself a superb analytical chemist who had spent his career in the Chemistry Division, but was now acting as chief of Metallurgy, brought physical chemist Lawrence M. Kushner to Metallurgy from Chemistry to form a new section called Metal Physics. As explained in the Annual Report for 1957: "The objective of the [metallurgy] program has always been to increase both theoretical and practical knowledge of metals. . . . A new metal physics laboratory has been instituted to augment the theoretical work carried on" in the division.<sup>291</sup> It is clear from the designation of the new unit as a "laboratory" rather than a section that it was expected to grow beyond section size, and it is also clear from the subsequent history that "theoretical" meant "basic," and not only strictly theory, although that also flowered.

A comparison of the sections in 1957 and 1964 shows the change in the nature of the work. In 1957 there were five sections: Thermal Metallurgy, Chemical Metallurgy, Mechanical Metallurgy, Corrosion, and Metal Physics. By 1964, the three metallurgy sections had coalesced into one called Engineering Metallurgy, and the Metal Physics Section had spawned three new sections: Crystallization of Metals, Alloy Physics, and Lattice Defects and Microstructure. Corrosion was still a section, but its program had changed dramatically, becoming far more basic than previously. The new division had a strong theoretical component, particularly in the areas of crystallization, diffusion, and dislocation theory.

Organizationally the new section structure arrived with the major Bureau reorganization into institutes, but the programmatic changes occurred continuously from the beginning of the period. Corrosion research became primarily concerned with the growth of passive films. A great deal of the work was concerned with the growth and breakdown of these films. A long series of studies was concerned with single crystals—primarily copper and iron—and the difference in film behavior on the various prismatic surfaces of the crystal. One of the principal aims of the studies was the development of techniques for the study of passive films and, as already mentioned in the discussion of the Polymers Division, the corrosion scientists, under the leadership of Jerome Kruger, joined the polymer group to make the Bureau a leader in the use of ellipsometry for measurements on film-covered surfaces.

Next to be implemented was the study of the growth of metal crystals from the vapor. Here the aim was to check existing theories of crystal growth. Experimentally, both crystals of normal habit and the perfect but microscopic needle-like crystals known as "whiskers" were studied. The reason for studying growth from the vapor was, of course, the ease of theoretical treatment, and because of the simple experimental situation. In vapor-phase growth the crystals are visible, whereas in growth from the melt they are not. But in 1964, experiments on the growth of high purity aluminum

---

<sup>291</sup> Annual Report, 1957: 51.

crystals by pulling from the melt were begun. Later this work would lead to important theoretical advances in studies of crystal form, known as morphological stability theory.

In 1959 the division began a program on nuclear magnetic resonance of metals and alloys. This was the division's entry into quantum mechanics and the electronic structure of metals and how it changed on alloying. Measurements were concerned with the Knight shift, which is the normalized difference in nuclear resonance frequency between a given metal nucleus in a reference compound and in a metal or alloy. Caused by the paramagnetic susceptibility of the s-like electrons at the Fermi surface of the metal, which cause a magnetic field at the nucleus, it gives information about the electronic density of states at the Fermi surface in the metal, and can be used as a complement to traditional methods in the study of crystallographic structure and phase transformations.

The study of electronic structure was reinforced in 1961 with the construction of a soft x-ray spectrometer, used to determine the density of electronic states throughout the whole conduction band and, in 1962, with a low temperature calorimeter, used to give the density of states at the Fermi level. The avowed ambitious aim of this whole effort was to "contribute critical data for the eventual formation of a quantitative theory of bonding in metals and alloys."<sup>292</sup> To further this provision of data, the division in 1966, with the help of the OSRD, began a center called simply the Alloy Data Center. In 1977 a massive four-volume compendium on Knight shifts, which gave a critical analysis of all the data in the literature at the time, was published.<sup>293</sup>

A third new effort, in diffusion, began in 1959 with the hiring of John R. Manning. The work was mostly theoretical. It was concerned with diffusion by vacancies and investigated such matters as vacancy flow in the presence of external driving forces, and correlations between atom motions. Experimental requirements led to the construction of an electron microprobe to measure the composition gradients in experimental diffusion samples. Due to the importance of diffusion to the science of metallurgy, an NSRDS data center, called simply the Diffusion Data Center, was opened in 1965. Its first publications were on diffusion in copper alloys, prepared with help from the International Copper Research Association.<sup>294</sup>

The final new effort was essentially electron microscopy coupled with x-ray diffraction. A great deal of the work was concerned with the direct electron microscopical observation of dislocations, a new capability eagerly pursued at the time in many laboratories. Beginning with the effect of dislocations on second phase precipitation

---

<sup>292</sup> Annual Report, 1961: 94.

<sup>293</sup> Gesina C. Carter, Lawrence H. Bennett, and Daniel J. Kahan, *Metallic Shifts in NMR* (Oxford: Pergamon Press, 1977).

<sup>294</sup> Daniel B. Butrymowicz, John R. Manning, and Michael E. Read, *Diffusion Rate Data and Mass Transport Phenomena for Copper Systems*, Part I (New York: International Copper Research Assoc., 1977), and Part II, 1981, with the same title but with Butrymowicz as the sole author.

(wherein the precipitate particles were initiated on dislocations) and the production of dislocations by plastic flow, the work developed into a study of stacking faults. These are caused in face centered cubic (FCC) metals by the splitting of a dislocation into two partial dislocations connected by a "stacking fault." This is a region of misfit between two crystal planes. The ultimate configuration is a strip of stacking fault with partial dislocations at its lateral edges, much like a street between curbs. The width of the fault increases as the energy of misfit between the atomic planes, or simply the stacking fault energy, decreases. Stacking faults are important since they have important effects on mechanical properties.

In an FCC metal, the stacking fault corresponds to a layer of close packed hexagonal (HCP) crystal. Now, some alloys of copper, silver, and gold show a phase transition from FCC to HCP at a given concentration of the alloying constituent. It follows that at the phase boundary the stacking fault energy should go to zero. Electron microscope studies in silver-tin alloys, extending well beyond the period, were consistent with this reasoning.<sup>295</sup> Begun during a period when direct observation of dislocations was a new science, it was a forward-looking piece of work.

### Applied Mathematics

The Applied Mathematics Division continued with its mission to carry out basic and applied research and to provide assistance and advisory services to the Bureau staff and other Government agencies. Much of the work was built around the use of computers, and the division had responsibility for the Bureau's computation laboratory, which provided computation service and technical assistance. This phase of its operation expanded during the period. Its IBM 704, obtained in 1957, was replaced in 1962 with a 7090-1401 system, with the 7090 in turn replaced by a 7094 in 1964.

While most of its scientific work continued in the areas of numerical analysis, statistical engineering, and mathematical physics, the actual problems undertaken reflected the changing nature of science and Government programs. Thus, in mathematical physics for example, a considerable amount of work sponsored by NASA was done on the theory of satellite orbits. This project was concerned with the motion of a satellite around an axially symmetric, but oblate planet, an approximation to the actual figure of Earth. Ramifications included taking into account equatorial asymmetry. Plasma physics was another mathematical physics area where the Bureau had a larger program. Part of this work was supported by the Bureau and was concerned with the transport properties of plasmas interacting with a magnetic field. Another aspect, supported by NASA, was concerned with the use of plasmas for rocket propulsion, and included plasma dynamics and the study of plasma oscillations.

---

<sup>295</sup> L. K. Ives and A. W. Ruff, Jr., "Extended Dislocation Nodes in a Silver-Tin Alloy," *Journal of Applied Physics* 37 (1966): 1831-1837; A. W. Ruff and L. K. Ives, "Stacking Fault Energy Determinations in HCP Silver-Tin Alloys," *Acta Metallurgica* 17 (1969): 1045-1055.

# EFFECTS OF EARTH'S OBLATENESS

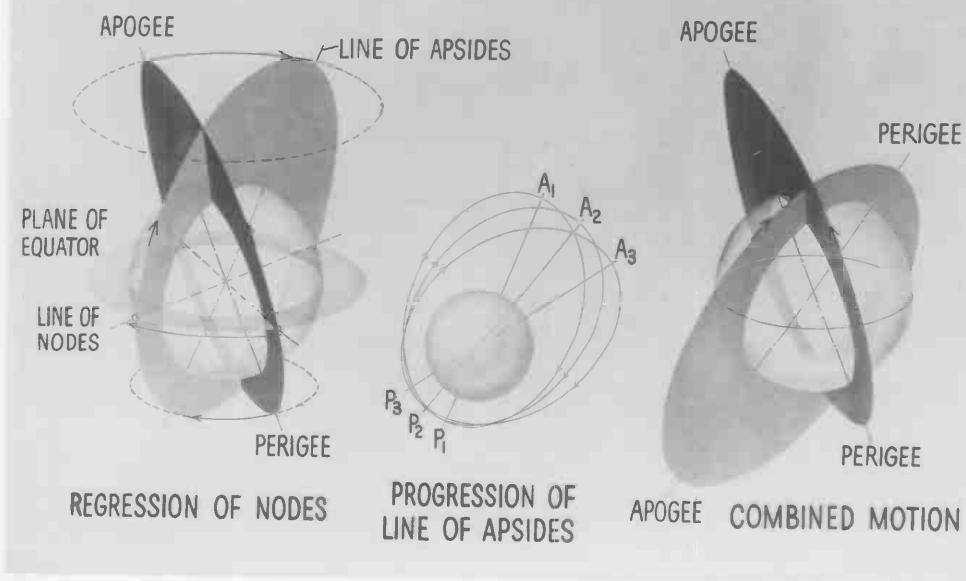

Previous efforts to calculate the effects of the earth's oblateness had used perturbation theory. In 1959, the Applied Mathematics Division at NBS devised a more direct approach to the problem which took into account the full oblateness of the earth at the very start of the calculation. (Courtesy of the National Aeronautics and Space Administration)

New areas came not only from mathematical physics, but also from mathematics and from the existence of the computer. These new areas were operations research, combinatorial analysis, and machine translation. Both basic and applied research were carried out in operations research. In the basic effort, there were studies in game theory, graph theory, weapons simulation, Boolean functions, and mathematical models of distribution networks. U.S. Post Office operations was a continuing area of application where, for example, studies of distribution networks had the aim of optimizing the location of mail distribution centers. A considerable amount of work was devoted to defense problems, such as the analysis and simulation of missile system operation, of electronic countermeasures, and optimal radar site distribution.

In mathematics, a new area of investigation was combinatorial analysis, the branch of mathematics concerned with the arrangement of finite sets of objects. It is essential in probability theory and in statistical mechanics. Its use was applied to the selection of the best pattern of linkages in transportation and distribution networks, in the determination of the most efficient method of encoding messages to provide automatic correction of transmission errors, and in the design of experiments to yield the

maximum amount of information with the least effort. On a more theoretical note, the concept of abstract spaces was introduced into combinatorial analysis.

The other new area, carried on from 1959 to the end of the period, was machine translation. The project was concerned with the translation of Russian into English. Featuring a Bureau developed system called "predictive analysis," in which a Russian word in a sentence predicts "certain other grammatical forms, as transitive verb predicts an object," and a procedure called "profiling," by which clause or phase boundaries are recognized, the system was tested in 1964 with success as far as the limited amount of storage in the computer permitted. Some progress had been made on this very difficult problem, but the project ended before complete success.

At the very end of the period, the division acquired a new function. An Interagency Committee on Data Processing had been formed in 1957 to serve as a forum for departments to discuss ADP problems of mutual concern and to serve as a medium for the exchange of information. In 1962, the committee recommended the formation of an Advisory Council to advise the Bureau of the Budget (BOB) on "plans, policies, and guidelines for the ADP program of the executive branch."<sup>296</sup> Astin, asked to appoint a member, named Samuel N. Alexander to the post.<sup>297</sup> In 1963, the Council recommended the formation of a Computer Sharing Exchange (the Exchange) and Computer Service Center (the Center). In addition, the Bureau was recommended as the logical place to house the activity since it was already carrying out many functions of the same type. With some minor provisos, Astin accepted the assignment.<sup>298</sup> Acting quickly by means of Bulletin 64-9, January 2, 1964, the BOB announced the establishment of such an operation at NBS.<sup>299</sup> Astin followed immediately with an announcement to heads of all executive departments and establishments on "Plans for Operation of an Experimental Computer Sharing Exchange and Computer Service Center."<sup>300</sup> Essentially, the Exchange part of the experiment was to facilitate the sharing of computers between Government organizations, and the Center part was the provision of actual computation. For the latter, the Bureau provided the facilities of the Computation Laboratory in the Applied Mathematics Division, placing the Exchange and Center in that division, which had been carrying out nearly the same function for many years. It was nothing completely new, but Astin now had solid justification for it.

---

<sup>296</sup> Letter, D. E. Bell, Director, BOB, to A. V. Astin, October 1, 1962. (RHA; Director's Office file; Box 381; Folder Chrono. 1962)

<sup>297</sup> Letter, A. V. Astin to D. E. Bell, October 18, 1962. (RHA; Director's Office file; Box 381; Folder Chrono. 1962)

<sup>298</sup> Letter, A. V. Astin to H. Seidman, August 21, 1963. (RHA; Director's Office file; Box 381; Folder CHRONO 7/63-12/63)

<sup>299</sup> Executive Office of the President, Bureau of the Budget, *Bulletin* No. 64-9, January 2, 1964.

<sup>300</sup> Memorandum, A. V. Astin to the Heads of Executive Departments and Establishments, "Plans for Operation of Experimental Computer Sharing Exchange and Computer Service Center," January 17, 1964. (RHA; Director's Office file; Box 381; Folder CHRONO 1/64-4/64)

## Data Processing

One of the Bureau's "special central missions" that accrued to it during and after World War II, the Data Processing Systems Division (renamed Information Technology in 1964) was a direct outgrowth of the Bureau's computer program. It served "both as a central research and development agency and as a readily available source of technical information for other Government agencies. The advisory services strengthen the basic program, which ranges from research in components and systems to advanced work in new computer applications."<sup>301</sup> Its work could be classified into four categories: the design and construction of new computers for special purposes; the study, analysis, and development of new components; the development of both general purpose computer programs and programs for specific purposes; and advice and assistance to other Government agencies.

The computer construction work was a direct result of the experience of designing and constructing the SEAC and SWAC computers. By the beginning of the period SEAC was seven years old, still going strong, and used for research on computer components. Nevertheless, this phase of the division's work would gradually lessen because of the explosive growth of the computer industry. New computers were constructed, particularly PILOT—a fast computer built specifically for data processing problems encountered in such Government operations as air-traffic control and patent searching. Another such special computer, AMOS IV, was constructed for the Weather Bureau to use in processing sensor data in an experimental automatic weather station. It was the fourth in a line of computers built for special Weather Bureau programs. A third computer was a portable analog device built for the Army Signal Corps that could predict radioactive fallout for a selected locality after a nuclear explosion.

The evaluation and development of components was a continuing activity. As early as 1957, transistors and solid state diodes were under active investigation for switching and other circuits. Memories were a constant source of study, and in a 1959 example of the work, the need for large random-access memories with read-write times of less than one microsecond led to the investigation of thin magnetic films as storage elements. By 1964, the computer field had exploded to the point where two staff members "were directed to maintaining current awareness of the latest components, devices, and circuit techniques."<sup>302</sup> The work on components had developed into a full scale research effort, with studies on ultra thin ferromagnetic films, the quantitative analysis of thin film by x-ray fluorescence, and the simulation and characterization of tunnel diodes and epitaxial transistors. It was solid state physics applied to computer components.

Two important general purpose computer programs—OMNIFORM I and OMNITAB—were produced during the period. The former, written by Joseph Hilsenrath of the Thermodynamics Group and Gerald M. Galler of the Computation Laboratory, was based on a general program for generating sixteen types of functions, and could generate tables of such calculations as anharmonic corrections for diatomic

<sup>301</sup> Annual Report, 1960: 14.

<sup>302</sup> Annual Report, 1964: 184.



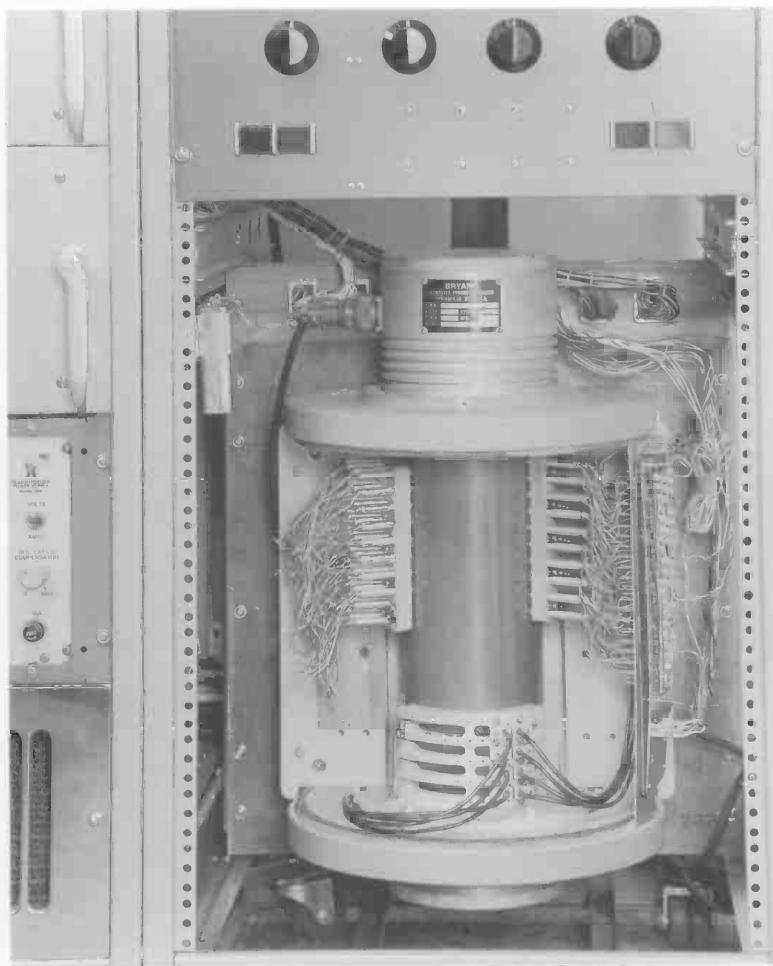

A view of the rotating magnetic drum, the main storage unit of the AMOS IV computer.

molecules virial coefficients for nitrogen gas, and negative exponentials corresponding to certain atomic energy levels. The related OMNITAB, developed by Hilsenrath, and Guy C. Ziegler and Philip J. Walsh of the Applied Mathematics Division, was a second generation general purpose program that permitted the user to instruct the computer by using simple sentences with familiar English words, such as "multiply  $a$  by  $b$ ." It was written primarily for persons who would normally carry out computations on a desk calculator and a multicolumned worksheet, but who did not use Fortran. The Statistical Engineering Laboratory adopted OMNITAB and produced a number of publications.

Other special programs, generally developed with other Bureau scientists or for other agencies, included:

- Rapid calculation of color differences.
- Collaboration with the Patent Office to develop programs for the comprehensive search of chemical patent literature, and for general searching, but with emphasis on the mechanical arts.
- Analysis of data on human heartbeats for the Veterans Administration.
- A program to produce a magnetic tape which could instruct a photocomposition machine under current development by the Mergenthaler Linotype Company and IBM. Developed because of the the need to publish extensive tables of atomic transition probabilities, this program brought the division into contact with the emerging field of computer-driven typesetting.

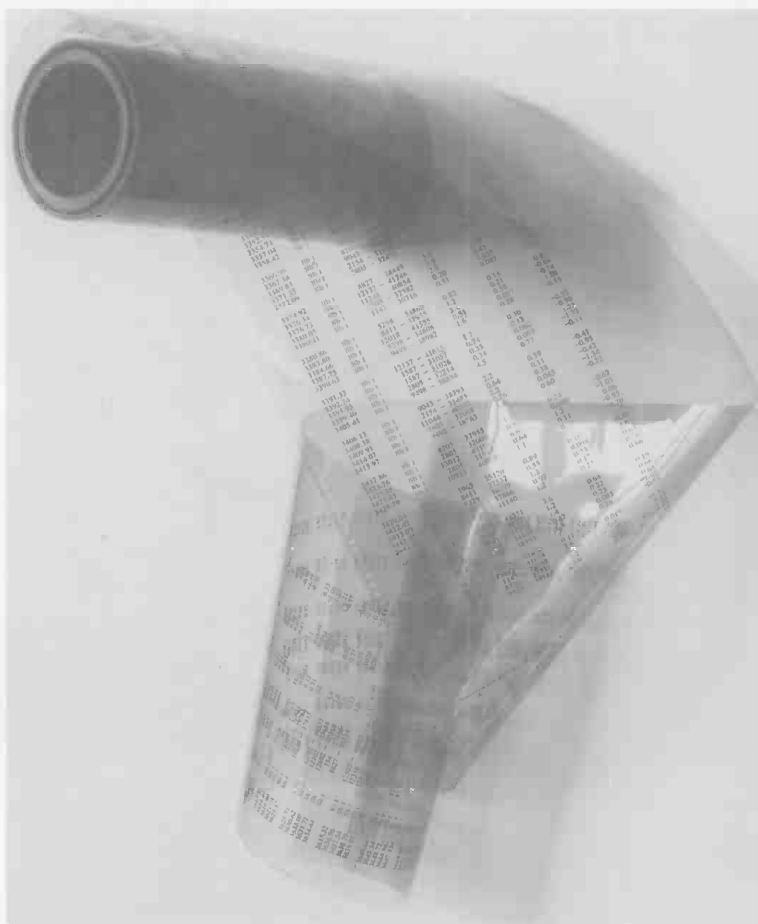

One of the rolls of 8 in wide photographic film positive from which printing plates were made for the Bureau's tables of experimental atomic transition probabilities.

A host of other agency projects were carried out, a number having already been mentioned. One of the most interesting was the formation with the National Science Foundation of a Research Information Center and Advisory Service on Information Processing in 1959. Located at the Bureau, the service was "designed to bring together research and development data on methods and equipment for the automatic processing of scientific information."<sup>303</sup> By 1964 it had collected 15 000 bibliographic references on information storage, selection, and retrieval. A few additional other-agency-funded projects in 1961 give a flavor of the work: assistance to the Bureau of Naval Weapons on problems of weapons-systems evaluation and test-range instrumentation of the Pacific Missile Range, studies of a future airtraffic control system for the Federal Aviation Administration (FAA), research for the Navy on computer methods for translating aerial photographic information into elevation profiles, and the development of a program for simulating municipal traffic flow by high speed computers for the Bureau of Public Roads. Unquestionably the biggest other-agency program was a continuing one with the Post Office Department on the development of methods for the most efficient handling of mail.

### **Instrumentation**

What began in 1950 as a small office operating a program on instrumentation became a full scale division with five sections in 1960. This change was prompted by the transfer of the electronics experts from the Electricity and Electronics Division to form the technical staff of an Instrumentation Division. The Electricity and Electronics Division again became the Electricity Division, as it had been previous to the merger in 1953. The old Office of Basic Instrumentation became a true technical research division.

As one phase of its operation, the new division developed instruments for specific purposes, primarily for other agencies. A few examples illustrate the nature of this work:

- The development of automatic weather stations, under Navy sponsorship, to measure and broadcast meteorological information, and the installation of a chain of such stations in Antarctica.
- The study of hygrometry and the development of new hygrometers.
- The study of pressure and displacement transducers. A calibration service for these devices was provided.
- An electronic scanning microscope for automatically scanning spectrographic plates.
- FOSDIC (Film Optical Scanning Device for Input to Computers), the most famous of the devices invented by the division, was developed for the Census Bureau's 1960 decennial index. FOSDIC read responses collected during the census and converted them into electronic signals for direct input to the computer. Later versions were developed for the Weather Bureau,

---

<sup>303</sup> Annual Report, 1959: 6.



This ocean-based weather station developed by NBS automatically reported local weather data by radio. It could be anchored in a remote location and left unattended for as long as six months.

the Office of Emergency Planning, the Department of Defense for its National Fallout Shelter Survey, again for the Census Bureau for its monthly collection of employment and unemployment statistics, and for NASA, for its conversion of personnel records to magnetic tape storage. This diversity in applications required new versions of the device, and by 1964 FOSDIC IV had been developed.

Interesting and useful as these instruments were, perhaps more important was the more general research. In 1960 the new division recognized that modern instrumentation relied on electronic techniques, even when the initial measurement was not electrical but converted to electrical signals by specialized sensors. The division announced an electronics program which included the investigation of materials used in "vacuum and semiconductor electron devices," and the "characteristics and capabilities of electron devices themselves."<sup>304</sup> A large part of this program was the study of semiconductor materials, leading the division into applied solid state physics. Characterized by working with actual industrial materials, one of the first projects was a new

<sup>304</sup> Annual Report, 1960: 100.

method for the measurement of minority carrier lifetimes in silicon, silicon carbide, and boron phosphide. The method was applicable in the millisecond lifetime range in small samples of arbitrary dimensions. This was followed by a study of the important problem of second breakdown in transistors, a failure mode of great concern to industry. No specific cause was found, but guidelines were developed for the mode of operation where such failure would not occur.

Other studies were concerned with the contacts to semiconductors and, under sponsorship of the Bureau of Naval Weapons, standards and measurement methods for Hall effect devices. Such a standard developed by the Bureau was proposed to the International Electrotechnical Commission as an American standard.

Perhaps the most important program in this area was begun in 1964 to improve the fundamental accuracy with which the electrical properties of semiconductors could be measured. Sponsored by ARPA, the program concentrated chiefly on the measurement of resistivity at room temperature, which industry indicated was their most important need. Various types of probes were investigated, concentrating on the effects of surface finish and on probe materials. The investigation was continuing. Indeed, it and its derivatives would continue for the remainder of this history. By contrast, the effort in basic semiconductor research carried out in the Atomic Physics and Analytical and Inorganic Chemistry divisions, which at this time was concerned with  $\text{TiO}_2$ , would eventually be curtailed.

The whole effort in this area of electronic materials was characterized by a close interaction between the Bureau, industry, and the voluntary standards system, particularly ASTM. The Bureau carried out its mission of providing measurement methods and data, and of working with the standards societies in ensuring the technical soundness of their standards. This phase of its work would have increasing importance.

### **Central Radio Propagation Laboratory**

As befits an organization whose work was described by the second Kelly Committee as being "of the highest quality,"<sup>305</sup> there was no need for the character of the work of the CRPL to change. Nicely balanced between basic and applied work, between science and engineering, it changed as science developed, and it grew. In 1957 appropriated funds were \$2.12 million,<sup>306</sup> but increased to \$4.28 million in 1964<sup>307</sup> plus an approximately equal amount transferred from other agencies, primarily the military. Organizationally, in 1958 the laboratory had two divisions, Radio Propagation Physics and Radio Propagation Engineering. By 1964 it had grown to four, with field stations spanning the planet either directly operated, on contract, or cooperatively manned with other countries.

The most famous program the laboratory was associated with in the period was the International Geophysical Year, of which we now give a brief account.

---

<sup>305</sup> Second Kelly Committee Report: 90.

<sup>306</sup> Appropriations Hearings for 1959: 412.

<sup>307</sup> Appropriations Hearings for 1965: 600.

## *The International Geophysical Year*

On July 1, 1957, as many as 20 000 scientists from 67 nations began the International Geophysical Year (IGY), a concerted and coordinated study of the earth and its atmosphere. For eighteen months, until December 31, 1958, they were to make observations and measurements of the earth's interior, its crust, its oceans, its atmosphere, and its sun, in an effort to achieve a better understanding of mankind's home. Earlier concerted studies of this kind had occurred during the Polar Year of 1882-83 and the Second Polar Year, which began on August 1, 1932, they were dwarfed by the magnitude of the IGY effort.<sup>308</sup>

The idea for such a year appears to have occurred spontaneously in April 1950. British geophysicist Sydney Chapman, who had participated in the discovery of various layers of the ionosphere during the Second Polar Year, visited Washington. He and a number of other scientists visited the Silver Spring home of James A. Van Allen of the Carnegie Institution of Washington on what started out to be a social occasion. The group came to the conclusion that further advances in the earth sciences required an intensive coordinated worldwide effort, and that new instrumentation and techniques and the advent of rocketry made such an effort propitious. Their ideas were submitted to Lloyd V. Berkner, then president of the International Conference of Scientific Unions (ICSU), who warmly embraced the concept and pressed the effort. Seven years later the IGY began.

The choice of the period July 1, 1957, to December 31, 1958, was not arbitrary. A maximum in the eleven-year sunspot cycle was expected during this period, offering an unexcelled opportunity to study the effects of the Sun on the earth's atmosphere and climate with modern instruments and techniques. The ICSU invited all nations to participate, and forty-six accepted the invitation, twenty-one more would join later. Illustrating the growing technological capabilities of the period, the ICSU passed a resolution "urging that the participating nations study the possibility of launching artificial satellites which would [give] scientists their first sustained view of this planet from outside its atmosphere. . . . Both of the leading world powers had indicated their intention to launch such satellites."<sup>309</sup> In fact, the United States planned on twelve satellites to be launched in conjunction with the IGY.<sup>310</sup> It will be recalled that the sputniks were launched only a few months after the beginning of the IGY, and the U.S. satellite *Explorer I* shortly thereafter.

Following a request from the ICSU, and with the concurrence of Congress, in March 1955 the NAS appointed a committee to guide the national effort for the IGY, and to maintain liaison with the NSF, which administered the \$39 million appropriated by

<sup>308</sup> An excellent account of the International Geophysical Year is given in three papers by Hugh Odishaw, all entitled "International Geophysical Year," (1) *Science* 127 (1958): 115-128; (2) *Science* 128 (1958): 1599-1609; (3) *Science* 129 (1959): 14-25.

<sup>309</sup> Walter Sullivan, "The IGY—Scientific Alliance in a Divided World," *Bulletin of the Atomic Scientists* 14 (1958): 69.

<sup>310</sup> Senate Committee on Appropriations, *International Geophysical Year: A Special Report Prepared by the National Academy of Sciences for the Committee on Appropriations of the United States Senate*, 84th Cong., 2d sess., 1956, S. Doc. 124: 17.

Congress for the effort. Called the United States National Committee, it was chaired by Joseph Kaplan, Professor of Physics from UCLA, and it had many parts: an Executive Committee, Committees on the Antarctic and the Arctic, Data Processing, a Continental Committee, and an Equatorial Committee. In addition, there were thirteen technical panels, ranging alphabetically from Aurora and Airglow to World Days. The Bureau was well represented on the committee. Alan H. Shapley of the Radio Propagation Physics Division was vice chairman of the main committee and also served on three subcommittees, chairing two technical panels (Solar Activity and World Days). Hugh Odishaw was executive director of the main committee, having taken a leave of absence from the Bureau to join the NRC staff specifically for this purpose. Allen Astin and Director Emeritus Lyman Briggs were members of the main committee. A number of other Bureau staff members served on subcommittees and technical panels.<sup>311</sup>

While the Bureau's effort in the IGY was only a small fraction of its activities, involving only about 100 staff members, primarily from the Radio Propagation Physics Division of the CRPL, it nevertheless played a significant role in the whole IGY effort.<sup>312</sup> Its two aspects might be called support, or staff functions and, of course, research functions in those areas where it had special competence. In the support functions, it operated as a World Warning Agency. Since the IGY had been chosen to coincide with a period of maximum sunspot activity, the Sun was under visual, optical, photographic, photometric, and radio observation for every minute of the IGY. The World Warning Agency, located at the Bureau's Fort Belvoir, Virginia, radio forecasting center, received all these data from all over the world, and processed them to maintain a constant account of the state of the Sun. During any periods of unusual activity, alerts were sent to scientists all over the world. In particularly interesting cases, "Special World Intervals" were declared during which scientific observations throughout the whole world were accelerated. Indeed, one such interval was declared even before the IGY formally began. A major solar flare was observed on June 28, 1957, two days before the official start of the IGY. The arrival on Earth of the particles associated with solar flares creates immense electrical disturbances in the earth's ionosphere, with radio signals being absorbed rather than reflected, thereby blacking out long range radio communication. Immediately on receipt of the news of the flare, an Alert was announced, and eight hours later, a World Interval was declared. Observations on the ionosphere, the Northern and Southern Lights, and the earth's magnetic field were intensified, and balloons and rockets were sent up to measure ultraviolet emissions, x rays, and cosmic rays. Observations, some by rocket, showed that a new layer of ionization was produced some twelve miles below the normally lowest point of the ionosphere, which remained otherwise undisturbed.<sup>313</sup>

<sup>311</sup> Ibid. This document gives a complete listing of all the parts of the committee and their membership. "The International Geophysical Year," *Technical News Bulletin* 39 (1955): 139, gives a listing of all Bureau representatives on the various parts of the committee.

<sup>312</sup> D. M. Gates, "Preliminary Results of the National Bureau of Standards Radio and Ionospheric Observations During the International Geophysical Year," *Journal of Research of the National Bureau of Standards* 63D (1959): 1-14.

<sup>313</sup> Odishaw, "International Geophysical Year," *Science* 127 (1958): 115.



Kent D. Boggs of NBS, one of the IGY World Warning Agency forecasters, entered solar data on a globe representing the Sun. The white chalk circles showed the location and size of sunspots.

The other support function was the operation of a data center. For the storage of the raw data accumulated during the IGY, three data centers had been instituted, labeled A, B, and C. Data center A was operated by the United States, with eleven sub-centers; center B was in the Soviet Union, with two sub-centers; and center C, with nine sub-centers, was operated by several European and Pacific Ocean nations. The Bureau operated a sub-center devoted to airglow and the ionosphere. The principal function of the centers was to store and index the data they received from all over the world, and to make them accessible to research workers.

The Bureau's scientific efforts were naturally concentrated in those areas in which it had the greatest research interests and competence. The most intensive effort was in the study of the ionosphere. The Bureau normally operated twenty sounding stations,





Reels of 35 mm film were kept in a humidified storage vault at the NBS Boulder Laboratories, forming a large part of the data cataloged and stored as the IGY World Data Center A for Airglow and the Ionosphere. Frances Stryker was photographed returning a reel to the rack.

but during the IGY it operated thirty-four, either directly or in cooperation with other nations.<sup>314</sup> The interest was in the study of the ionosphere in the region of the equator, for which a closely spaced chain of sounding stations (operating on a fifteen-minute

<sup>314</sup> The customary way of studying the ionosphere is by a process called "sounding," in which radio signals are sent vertically upward from a pulsed transmitter while slowly sweeping the radio frequency. A signal is reflected from the ionosphere when the frequency of the signal and the electron density in the ionosphere are appropriately related. Thus by observing the echoes from the ionosphere, it is possible to map out the electron density of the ionosphere as a function of the height. Based on such studies, the ionosphere is customarily divided into four layers: D (the lowest), E, F<sub>1</sub>, and F<sub>2</sub> (the highest), although the layers overlap. It is this reflecting ability that makes long-range radio communication possible.

cycle) was instituted; the measurement of electron density profiles along the seventy-five degree meridian, from essentially the equator to Fort Monmouth in New Jersey; and vertical incidence sounding at five stations in Antarctica, where for the first time studies were made over either of the two poles. Surprisingly, these showed that there was a weak diurnal variation during the polar winter.

Another area of interest was the propagation of VHF signals in the Far East. It was known that propagation by the sporadic E layer<sup>315</sup> of the ionosphere was enhanced more in this area of the world than in comparable regions in the Western Hemisphere. Hence comparable propagation circuits were established in both hemispheres. Studies showed that the sporadic E enhancement was indeed greater in the eastern circuit, but that the F region also contributed.

Other areas of interest to the Bureau workers were the comparison of the propagation of VHF signals in the Far East and those in the Western Hemisphere; VHF forward scatter in the equatorial regions, which had never been studied systematically; the study of radio noise by a special network of IGY stations which showed that local conditions were important in determining the noise level; and airglow observations, where one of the attempts was to determine if there was any relation between this phenomenon and the aurora, with undecided results. Finally, there were some satellite observations. Within twelve hours of the announcement of *Sputnik I*, workers for the CRPL had modified existing pieces of equipment to receive the 20 MHz and 40 MHz signals from the satellite. By setting up interferometers at these frequencies, the "radio" direction of the satellite could be obtained and compared to the visual direction. Differences in these two directions could be attributed to refractive index gradients in the ionosphere at the radio frequencies, and thereby giving an idea of the structure of the ionosphere which could be compared to the sounding data. Similar and more extensive studies of this type continued with other satellites.

The CRPL participation in this type of international program did not end with the IGY. In 1964-1965, the IGY was followed by the International Year of the Quiet Sun (IQSY), chosen because the Sun was expected to be in a quiet phase. The interaction of the CRPL with this new program was much the same as it had been for the IGY, and consisted of coordination and direction of ionosphere and airglow projects, operation of a Western Hemisphere Radio Warning Service, and operation of the World Data Center-A for Airglow and Ionosphere.

\*\*\*

There is perhaps no better way to illustrate the development of the CRPL program than its interaction with the Nation's space activities. The interaction was of two types: the use of rocket and satellite capabilities to carry out CRPL's own programs, and the provision of data and consultation for other parts of the Nation's program.

The utilization of space capabilities employed rockets and satellites to study the ionosphere from above—for sounding in the downward direction. The problem is that ground-based sounding cannot measure the electron density above the height of its maximum (approximately 300 km). Pulses that penetrate this region are not reflected,

---

<sup>315</sup> This is a portion of the E layer that appears and disappears intermittently.



Four-stage Javelin rockets were used to carry instrumentation above the ionosphere in suborbital tests of topside-sounding satellite payloads.

but are lost to space. To study the ionosphere above this height, soundings need to be taken from above, hence the name “topside sounder.”<sup>316</sup>

Both rockets and satellites were used for this purpose. All launchings and flights were, of course, under the control of NASA. First, two Javelin rockets were launched from Wallops Island to a height of approximately 1000 km, the first on June 24, 1961, and the second on October 3 of the same year. With the aim of testing the system

<sup>316</sup> W. Calvert, R. W. Knecht, and T. E. Van Zandt, “Ionosphere Explorer I Satellite: First Observations from the Fixed-Frequency Topside Sounder,” *Science* 146 (1964): 391-395.

that would be used later on satellites, the first rocket obtained pulse reflection for thirteen minutes. The second also worked flawlessly, and it detected local ionization irregularities about 20 km in diameter and an east-west spacing of 1 km to 30 km. The flight data also yielded information that led to a modification of the instrumentation.

The next experiment was not really a Bureau effort, but a Canadian one. This was a top-sounding satellite named *Alouette I*, launched September 29, 1962, which gave a considerable amount of new data, with the CRPL participating in its analysis. But the experiment was not completely satisfactory. The sounder was a swept-frequency device which required eighteen seconds per sweep, during which time the satellite moved 130 km, hence the technique was unsuited to studying irregularities in the ionosphere.

The final experiment was *Ionosphere Explorer I* (also called Ionosphere Explorer A, S-48, Fixed Frequency Topside Sounder Satellite, TOPSI, 1964 51 A, and Explorer XX), which took soundings at six fixed frequencies. With a time of only 0.105 seconds between successive soundings at the same frequency, the satellite moved only 800 meters between readings, making it much more suitable for studying lateral ionospheric irregularities. Like *Alouette I*, it was in a nearly circular orbit approximately 1000 km high with an inclination of 79.9°, so that it could study the ionosphere from the tropics to the arctic regions. It began yielding information from the start.

Not only did the CRPL use space technology to further its own program, it provided NASA with advice and consultation on communications problems. In a 1962 study begun before President Kennedy's announcement of a planned lunar landing, it provided information to help plan communications between points on the lunar surface, predicted the power required, and analyzed ground-proximity losses and noise sources. During the Project Mercury flights of astronauts Walter M. Schirra, Jr., and L. Gordon Cooper, special hourly forecasts of radio propagation conditions were issued for the high frequency circuits that comprised the ground communications network. And during the period between orbital flights, forecasts were issued weekly with daily updates as necessary. All of this was done to ensure reliability of communications in obtaining data from the astronauts and spacecraft equipment, and telemetering it to tracking stations and the Mercury Control Center at Cape Canaveral, Florida. The CRPL was in a central position to assure reliable communications for the space effort.

## Cryogenics

As its name implies, the Cryogenic Engineering Division was a fully integrated engineering laboratory. Begun as a means of producing liquid deuterium for the hydrogen bomb, it became an essential part of the Nation's missile and space programs, concerned with all the problems involved in the production, transport, and use of the cryogenic liquids—primarily hydrogen and oxygen—that were crucial for those programs. Indeed, it was the sole supplier of those liquids in the early days. But it also provided measurement methods, data, and equipment design for science and the Nation's fledgling cryogenics industry. As an engineering laboratory, it was interested in producing things, not merely studying them, and as an integrated laboratory it developed the scientific and engineering background information necessary for the

effort. Its work can be classified into four categories: materials, processes, equipment and instrumentation, and production of cryogenic liquids.

Materials studies were concerned with materials of construction, materials for sensing elements, and with the cryogenic liquids themselves. A long series of studies addressed the mechanical properties of stainless steels at temperatures as low as that of liquid helium, approximately 4 K. Chosen for their ductility at these low temperatures, some alloys showed the formation of the embrittling martensite phase upon storage and cycling to the low temperatures. However, detailed studies showed that the resulting two phase structure was quite well behaved mechanically.

One set of studies on sensor materials was concerned with thermocouples. Because thermocouples used at these low temperatures can be affected by heat conduction, the thermal conductivity of a gold-cobalt alloy widely used in such thermocouples was measured down to 4 K, which permitted the errors caused by conduction to be estimated. To round out the project, the temperature-emf relationship for this same alloy against copper and silver-gold alloys was determined down to 20 K for these widely used thermocouples. While no substitute for the platinum resistance thermometer, these thermocouples were much easier to use and provided an uncertainty of about 0.1 K, which was sufficient for most engineering purposes.

Cryogenic insulation was, of course, a constant concern. In 1959 a new insulation consisting of a laminate of alternate layers of aluminum foil and thin fiberglass batt or paper, provided a ten-fold improvement over the customary powdered insulation when properly handled and applied. Cryogenic liquids also received considerable attention. The PVT relationships for *para*-hydrogen over the temperature range 20 K to 100 K at pressures up to 350 atmospheres were determined, tables of thermodynamic functions computed, and dielectric constants and viscosity determined—all essential design properties for the use of liquid hydrogen in rocket propulsion systems.

Later in the period some of the work changed from this intensively applied character and became very basic. Thus, investigations were carried out on the superconducting energy gap in thin films, and experiments were underway in 1964 on the the Fermi surface of niobium which, alloyed with tin, forms a high-field, type II superconductor.

A number of processes peculiar to cryogenics were under constant investigation. Fluid flow, important for the design of flow meters, received considerable attention. For cryogenic liquids, flow is complicated by the fact that both liquid and vapor are generally present. This causes "choking" (or, in automotive parlance, "vapor lock") at constrictions such as valves, which greatly limits the flow rate. Idealized theoretical solutions for predicting the upper and lower limits for such flow were obtained and could be used as broad design guides. Refrigeration was another process under continuous investigation, and notably led to the development of an expansion engine rotating at 9000 revolutions per second to 10 000 revolutions per second. The 0.3116 in diameter turbine, which could be held in the palm of the hand, could produce 200 W at 21 K to 30 K, and 8 W at 4 K. In heat transfer, a problem develops when a very cold surface is exposed to the atmosphere, as occurs in vaporizers, uninsulated transfer lines, air dryers, and missile tanks. In such cases, frost forms, and studies on the frost formation and heat and mass transfer on such surfaces were carried out. Wind velocity, temperature, and humidity of the atmosphere on a surface at a temperature of 77 K were

investigated. An interesting conclusion was that condensation which takes place in the boundary layer, but does not contribute to frost formation, is important in heat transfer.

It is not surprising to find an engineering division producing equipment. In fact, the division worked on pumps, bearings, transfer systems, containers, magnets, couplings, pressure transducers, flow meters, storage and transport equipment, and a liquid hydrogen bubble chamber. This equipment was produced primarily for the military missile programs and the civilian rocket and satellite programs, and included such items as a truck transport vehicle for 6000 gallons of *para*-hydrogen, and a distillation column for separating liquid hydrogen and deuterium. Perhaps most notable was the assistance provided to the University of California Radiation Laboratory in the construction of a liquid hydrogen bubble chamber to be used in fundamental particle high-energy physics. Successfully operated in 1958, the 72 in chamber contained 550 L of liquid

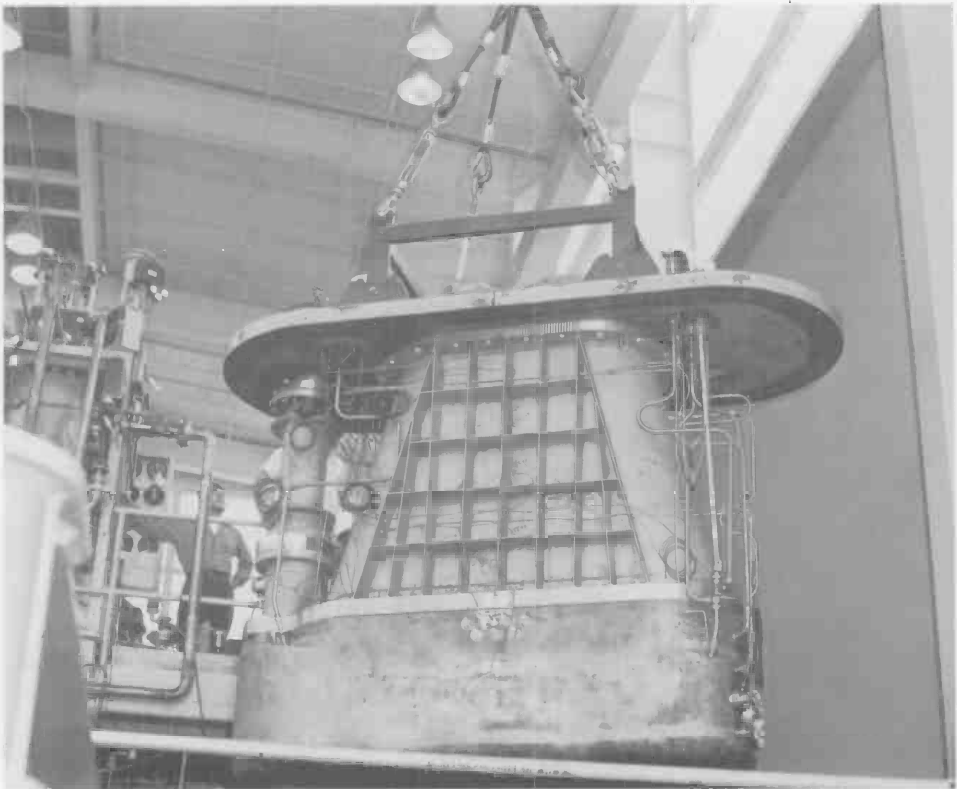

The 72 in liquid hydrogen bubble chamber at Lawrence Berkeley Laboratory. (Courtesy of Lawrence Berkeley National Laboratory)

hydrogen, and a Bureau-designed hydrogen refrigeration system provided continuous cooling and temperature control. Unlike the rest of the division's output, this was a direct service to fundamental science, rather than to engineering programs. Another notable program somewhat out of the mainstream for the division at that time was in magnets. Here the aim was to produce very-high-field magnets for use in particle accelerators in high-energy physics, in magnetohydrodynamics studies, and for plasma containment in nuclear fusion reactors. Two routes were available, one via high-field superconductors, and the other via cryogenically cooled normal-metal magnets. In the former area, in collaboration with the Metallurgy Division, a magnet wound with niobium-clad superconducting  $Nb_3Sn$  wire produced in the Metallurgy Division was built and produced fields up to 190 000 gauss (19 tesla). It was a precursor of what would become standard magnet technology. The other route

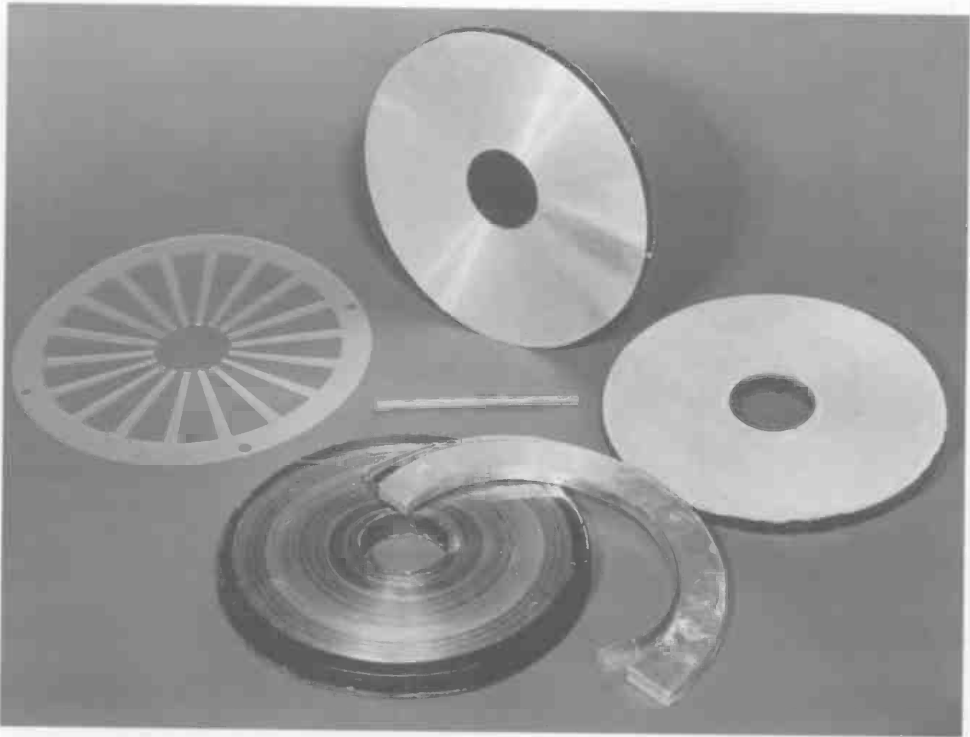

In 1963, scientists at NBS helically wound alternate layers of aluminum foil and capacitor paper to form the coil of a high-field cryogenic magnet. This photograph shows slabs (center front) that were cut from the cylindrical coil, machined to a smooth surface (center rear), and etched with sodium hydroxide (right) to prevent metallic short-circuiting at the edges of the turns. Fourteen such slabs, stacked alternately with polyester separators (left), were connected in series by copper wires. The separators provided electrical insulation and channels for liquid hydrogen cooling medium.

led to the production of a solenoid magnet using aluminum as the conductor. Made up of a stack of "doughnuts" formed of aluminum foil separated by paper, the magnet was cooled by liquid hydrogen and produced a field of 70 000 gauss (7 tesla) in a hole cavity 3 in in diameter and 8 in long. It was an impressive achievement, but such technology would be superseded by the superconducting magnet.

The division operated a production plant that produced cryogenic liquids shipped throughout the whole Nation. The peak production was in 1959 when the division produced 280 000 L of liquid *para*-hydrogen, 1 200 000 L of liquid nitrogen, and 4800 L of liquid helium, about half of which was air-shipped to Washington for use in the free-radicals program. With the ending of that program and the expansion of commercial production, this phase of the division's activities began to decrease. By 1963 all the liquified gases used in the Boulder Laboratories were procured from commercial sources; none was produced by the division. However, the helium liquefier was maintained in a standby mode in view of the uncertainty of commercial availability. The liquid hydrogen plant was still used for research purposes, but the liquid nitrogen plant was declared surplus. While any ending is sad, there was the consolation that it was the success of the division's program that ran it out of the cryogenic liquid business.

Finally, we should mention another important part of the division's activities. In 1958 it began a Cryogenic Engineering Data Center, which periodically published compendia of data and bibliographies. In 1962 it began emphasizing thermophysical properties, and in 1964 it became part of the recently-formed NSRDS. From input to output, the division was a complete operation.

### **Building Research**

As a central agency in the Government for the advancement of knowledge in the building sciences, the Building Technology Division, renamed the Building Research division in 1961, carried out a broad program on building systems, components, and materials. From plumbing systems to roofs, from concrete beams to heat pumps, from thermal insulation to asphalt, there was hardly a portion of building science not covered by its work. During the period most of the work was a continuation of that done from 1950 to 1957, but there was one important new phase. In 1960, the cement testing program was moved from the Mineral Products Division to the Building Technology Division, along with the associated research on cement. There concrete was added to the testing function, and the study of cement and concrete became the single most intensively studied area in the division's total program. Some of the work was, indeed, on the basic side. For example, in a study of how the cement-aggregate bond in concrete was affected by shape and chemical factors, polished aggregate specimens of various materials were partly imbedded in cement and the shear strength of the bond determined. In another area, the study of crack growth in concrete beams indicated that fracture mechanics could be applied to the problem.



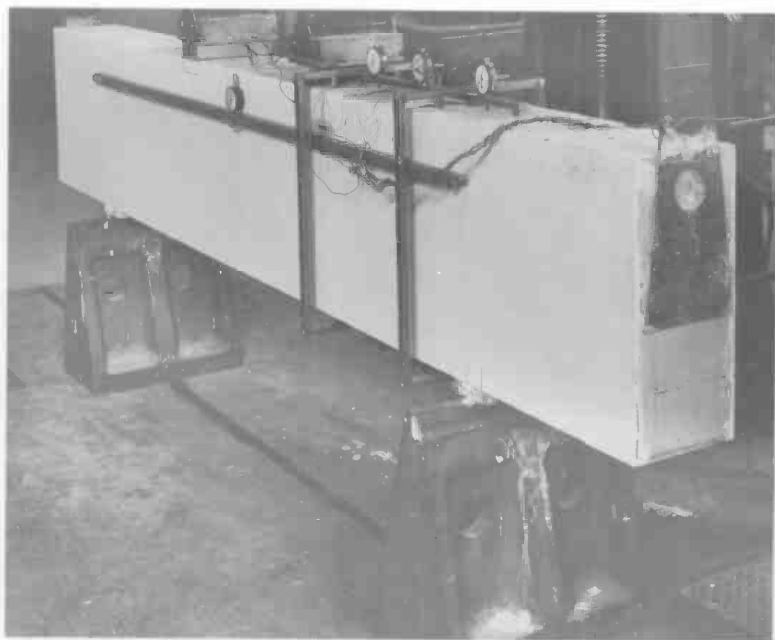

A test setup at NBS for loading reinforced concrete beams. A number of beams were loaded to failure to study the redistribution of stress as the beams cracked.

Another area that received considerable attention was the measurement of thermal conductivity in thermoelectric materials used for direct conversion of heat energy to electricity. Here the work was concerned with developing new methods of measurement and providing specimens of the right shape and size to be used as thermal conductivity reference standards for investigations of solid semiconductor materials. Thus, in 1960, an apparatus using small specimens (0.5 in by 1 in diameter discs) was developed for determining the steady-state thermal conductivity of semiconducting materials. In 1963 a new method of measurement using radial heat flow was developed. Thermal conductivity reference standards over a range of conductivities and temperatures were made available through the Standard Reference Material activities.

As in the previous period, asphalt was a material of continuing study. A particularly interesting result showed that the asphaltene fraction (the dispersed phase) of asphalt carries a positive electric charge and shows electrophoretic mobility when suspended in nitromethane. However, attempts to correlate electrophoretic mobility with durability were unsuccessful, indicating that the polar bonding forces had little effect on this important property.<sup>317</sup>

<sup>317</sup> Annual Report, 1963: 189; J. R. Wright, R. R. Minesinger, "Velocity-Depth Relationship in Microelectrophoresis Cell for Asphaltenes in Nitromethane," *Journal of Colloid Science* 18 (1963): 802-804.

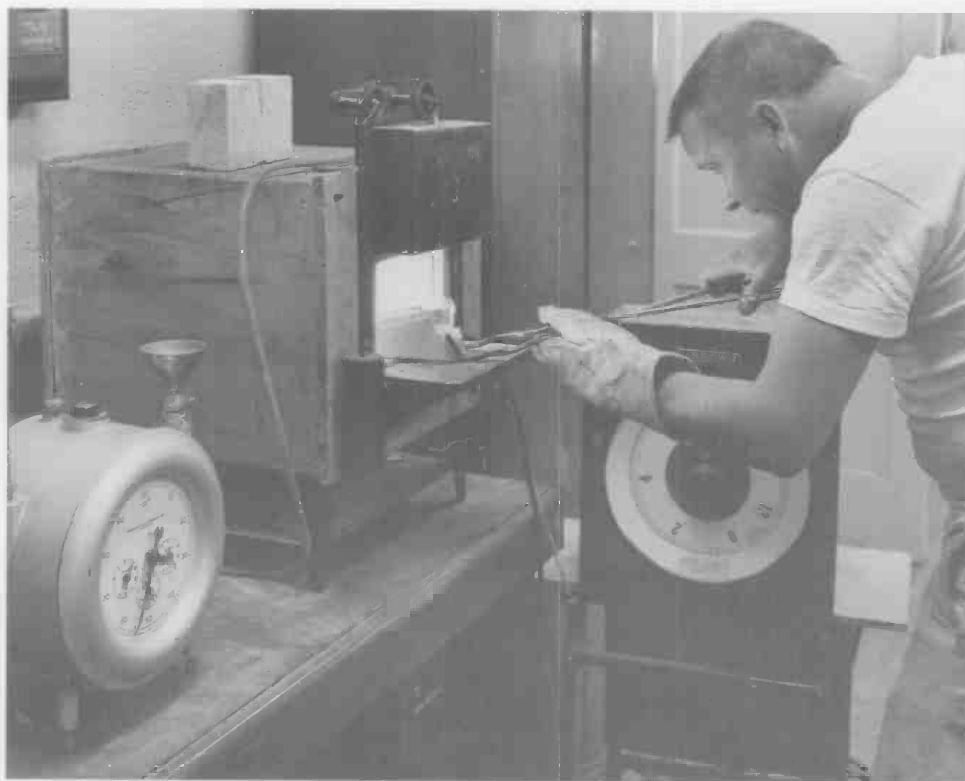

Joseph J. Loftus placed specimen container and firebrick support in a muffle furnace for firing. This was one step in the procedure developed at NBS for measuring the potential heat of materials in building fires.

Fire was, of course, an important part of the division's program, with studies of the fire hazards of common combustible materials, of fire retardants for fabrics, of the mechanisms of fire extinguishment, of surface flammability, and of the potential heat of materials in building fires.

Two other projects show directions in the development of fire research. In the first, the electron attachment coefficient of gaseous flame-inhibiting agents was studied. Coefficients considerably greater than that of oxygen were observed for twenty-three halogenated hydrocarbon agents. A qualitative correlation with flame inhibition was found, but electron attachment was not a sufficient condition for flame inhibition since some substances with high coefficients showed no flame inhibition.<sup>318</sup>

<sup>318</sup> T. G. Lee, "Electron Attachment Coefficients of Some Hydrocarbon Flame Inhibitors," *Journal of Physical Chemistry* 67 (1963): 360-366.

Finally, there was a project in the area of structural endurance in fires. In it, James V. Ryan and Alexander F. Robertson attacked the problem of finding a criterion for the onset of collapse of a structure in a fire, i.e., the condition at which a test assembly exposed to a fire fails to sustain the applied structural load. In a concise and straightforward way, they provided an analysis and a simple load-failure criterion for floors and beams based on both a limiting deflection and a limiting rate of deflection.<sup>319</sup> While not extensively used in the United States, this criterion has been adopted rather widely elsewhere.<sup>320</sup>

---

<sup>319</sup> J. V. Ryan and A. F. Robertson, "Proposed Criteria for Defining Load Failure of Beams, Floors, and Roof Constructions During Fire Tests," *Journal of Research of the National Bureau of Standards* 63C (1959): 121-124.

<sup>320</sup> Daniel Gross, private conversation.

---

## CHAPTER FIVE

---

### TECHNOLOGICAL TRIUMPH: SOCIAL TURMOIL, 1964-1969

#### THE VIETNAM AGONY

When Vice President Lyndon B. Johnson assumed the presidency after John F. Kennedy's assassination, he inherited Vietnam. In 1963, the South Vietnamese were assisted by 16 000 Americans acting as "military advisors" or conducting "combat support" missions. Americans were already dying; seventy-seven died in that year.<sup>1</sup> However disturbing the situation, Johnson felt that he could not disengage. As he was later to say, "if I left that war and let the Communists take over South Vietnam, then I would be seen as a coward and my nation would be seen as an appeaser and we would both find it impossible to accomplish anything for anybody anywhere on the entire globe."<sup>2</sup> While the president did not want to be called a coward untrue to Kennedy's commitment, he also feared deeply that Vietnam might escalate into a third world war.<sup>3</sup> Johnson thus began a forced-step by forced-step, start-and-stop escalation of the war.

Johnson took the first major step on August 2 and 4, 1964, in the Gulf of Tonkin. There, in international waters, three North Vietnamese patrol torpedo boats fired on the American destroyer *Maddox*. The president ordered reprisal bombing of North Vietnamese patrol boat bases and oil depots. At Johnson's request, the Congress passed a Joint Resolution on August 10 that approved and supported "the determination of the President, as Commander in Chief, to take all necessary measures to repel any armed attack against the forces of the United States and to prevent further aggression."<sup>4</sup> The resolution, a tacit declaration of war, was passed with a House vote of 414-0 and a Senate vote of 88-2. The Congress was solidly behind the president. Early in 1965, communist insurgents in South Vietnam—known to themselves as the National Liberation Front but derisively referred to as the Viet Cong—attacked a U.S. Air Force barracks at Pleiku, killing 8 American soldiers and wounding 126 others. Johnson resumed bombing and committed U.S. ground troops to fight. Thus began a cycle of battles, bombing halts, ignored proposals for peace conferences, and resumptions of bombing. The targets and scale of the bombings were personally chosen by the president, who was inhibited by the possibility of provoking Chinese or Soviet retaliation. Troop strength was increased periodically. By the end of 1965 American

---

<sup>1</sup> James MacGregor Burns, *The Crosswinds of Freedom: From Roosevelt to Reagan—America in the Last Half Century* (New York: Vintage Books, 1990): 390-391.

<sup>2</sup> Johnson quoted in Doris Kearns, *Lyndon Johnson and the American Dream* (New York: Harper & Row, 1976): 252.

<sup>3</sup> Kearns, *Lyndon Johnson*: 253.

<sup>4</sup> Joint Resolution *To promote the maintenance of international peace and security in southeast Asia*, U.S. Statutes at Large, 78(1964): 384.

troop strength was 180 000. It rose to its maximum of almost 550 000 troops by the end of 1967.

In April 1965 the undercurrent of protest that had been present since the beginning of American involvement in Vietnam became a rushing torrent. Tens of thousands of young people, along with intellectuals, teachers and entertainers, came to the Nation's capital to picket the White House and march to the Washington Monument for songs and speeches protesting the war. Similar marches by large and small groups were occurring ever more frequently throughout the Nation. Coupled with these anti-war protests were student revolts against university administrations. Anti-war demonstrations, sit-ins, and teach-ins took place at many of the Nation's finest educational institutions. Unrelated to the Vietnam War but even more destructive were riots that took place in the black sections of the Nation's largest cities. In the hot July of 1964 major riots broke out in Harlem and Brooklyn and then spread to Rochester, Jersey City, Paterson, Chicago, Cleveland, and Philadelphia. In August 1965 the predominantly black Watts section of Los Angeles erupted into six days of rioting and arson. In July 1967 riots in Detroit killed forty-three people; a situation so serious that President Johnson was forced to call out the 18th Airborne Corps. In the words of Paul Johnson, "large-scale riots by blacks in the inner cities became a recurrent feature of the Sixties, in sinister counterpoint and sometimes in deliberate harmony with student violence on the campuses."<sup>5</sup> The self-immolations at the Pentagon and outside the United Nations building, and the tragic events on the campus of Kent State University, where rookie soldiers fatally shot students who had vandalized the ROTC building, epitomized the chaos. Together, the triple stridencies of war protest, rebellion against racial discrimination, and student unrest—all catalyzed and heightened if not caused by aversion to the war—sounded a shrill note in the second half of the decade.

The revolt against the war was not confined to anti-war activists. Noted columnist Walter Lippman turned against the Johnson policy. Martin Luther King broke with the president, calling his own Government "the greatest purveyor of violence in the world today."<sup>6</sup> Antagonism spread to the halls of Government. Senator Richard Russell of Georgia and lawyer/statesman Clark Clifford, both formerly close to the president, now broke with Johnson and his policies. In Congress, Senator Fulbright, who had guided the Gulf of Tonkin Resolution through the Senate, became a strong opponent of the war.

In February 1968, in the midst of this turmoil, the Viet Cong and the North Vietnamese Army attacked. In an operation called the Tet Offensive because it came during the normally festive and peaceful Lunar New Year celebration, or "Tet," more than one hundred cities in South Vietnam, including Saigon, Hue, and Khe Sanh, were attacked. The attackers achieved early success, but after a month of bitter fighting, the United States and South Vietnamese defenders regained all lost ground and inflicted

---

<sup>5</sup> Paul Johnson, *Modern Times: The World From the Twenties to the Nineties* (New York: HarperPerennial, 1992): 646.

<sup>6</sup> King quoted in Barbara Tuchman, *The March of Folly: From Troy to Vietnam* (London: Cardinal, 1990): 426.

huge losses on the enemy forces. It was a serious loss for the Viet Cong, and they were thought to be essentially finished as a fighting force. National Security Advisor Walter W. Rostow said, "The other side is near collapse."<sup>7</sup> But the mere fact that the North Vietnamese forces could mount such an attack gave them a psychological victory. The prevalent media perception was aptly expressed by Walter Cronkite, who, having gone to Vietnam to see the results of Tet, was said to have declared, "What the hell is going on? I thought we were winning the war!"<sup>8</sup>

The Tet offensive occurred at the beginning of an election year, and less than a month later the New Hampshire primaries were held. The vigorously anti-war Senator Eugene McCarthy entered the presidential race and in the primary garnered 42 percent of the vote. This was an amazing achievement against a sitting president, particularly one as politically skilled as Johnson. The president won the majority of the votes, but McCarthy won the headlines. It was Johnson's own Tet.<sup>9</sup> Sensing Johnson's weakness, Robert F. Kennedy entered the race.

On March 31, 1968, President Johnson took to the airwaves to announce a unilateral halt to naval and air bombardment above the 20th parallel and to call for peace talks. Historian James MacGregor Burns, aptly describes what happened next:

Then, as his listeners stared speechless at their television screens, the President said at the end of his talk, 'I shall not seek, and I will not accept, the nomination of my party for another term as your President.' He had had enough, he told Doris Kearns later. He was being stampeded from all directions—'rioting blacks, demonstrating students, marching welfare mothers, squawking professors, and hysterical reporters.' Then the thing he had feared most—Bobby Kennedy back in the fray, embodying the Kennedy heritage.<sup>10</sup>

Yet only three days after Johnson's speech, to the surprise of everyone, Hanoi announced that it was ready to meet with U.S. representatives to begin preliminary negotiations. Talks did begin, but they were about "where to hold the talks, about protocol, about participation by South Vietnam and the NLF [Viet Cong], about seating and even the shape of the table."<sup>11</sup> The United States maintained its bombing halt above the 20th parallel, but the fighting continued, killing 14 000 Americans in 1968.<sup>12</sup>

As if to underscore the mindless suicidal tenor of the times, two calamitous assassinations occurred in quick succession. Less than a month after Johnson's speech, Martin Luther King was shot by escaped convict James Earl Ray. Riots exploded in cities and towns across the Nation. Heaviest hit was Washington D.C., which experienced 700 fires and 10 deaths. Then, in early June, after speaking out against violence,

<sup>7</sup> James Trager, *The People's Chronology: A Year-by-Year Record of Human Events From Prehistory to the Present* (New York: Holt, Reinhart & Winston, 1979): 1119.

<sup>8</sup> Burns, *The Crosswinds of Freedom*: 411.

<sup>9</sup> *Ibid.*, 412.

<sup>10</sup> *Ibid.*, 413.

<sup>11</sup> Tuchman, *The March of Folly*: 448.

<sup>12</sup> *Ibid.*

Robert Kennedy was shot while leaving a Los Angeles hotel. As he took what was presumed to be the safer route through the kitchen, he was killed by a bullet from the pistol of a disaffected Jordanian-American, Sirhan Sirhan.

Later that summer at a stormy Democratic nominating convention, young war protestors fought pitched battles with the Chicago police. These demonstrators were perhaps more intent on disrupting the proceedings than on forcing the nomination of their chosen candidate, George McGovern. Despite their agitation, the moderately liberal Vice President Hubert Humphrey was nominated. The Republican candidate was Richard Nixon. Aided by the third-party candidacy of Alabama Governor George Wallace, who siphoned off almost 14 percent of the vote, Nixon won the election with 31.8 million votes as compared to Humphrey's 31.3 million. It was a meager victory, but Nixon was the new president. Vietnam was now his problem.

### A SPATE OF LEGISLATION

In comparing his feelings toward the Great Society with those for his inherited Vietnam problem, President Johnson told biographer Doris Kearns, "If I left the woman I really loved—the Great Society—in order to get involved with that bitch of a war on the other side of the world, then I would lose everything at home. All my programs. All my hopes to feed the hungry and shelter the homeless. All my dreams to provide education and medical care to the browns and the blacks and the lame and the poor."<sup>13</sup> Although he did become more and more deeply involved with "that bitch," Johnson did not entirely desert his beloved. During his administration, laws were passed that permanently changed the social and political landscape. Some of those laws also had a direct impact on the National Bureau of Standards.

In his first year, Johnson saw the Food Stamp Act of 1964 passed and he skillfully guided the epochal Civil Rights Act of 1964 through Congress followed by the equally important Voting Rights Act of 1965. In the same year, Congress passed a momentous group of Johnson's proposals—the Social Security Amendments of 1965 (Medicare), the Elementary and Secondary Education Act of 1965, the Higher Education Act of 1965, and the Housing and Urban Development Act of 1965—and also created the National Foundation on the Arts and the Humanities. The Child Nutrition Act of 1966 followed and later in 1968 the Handicapped Children's Early Education Assistance Act.

Throughout the Johnson administration environmental concerns were constantly addressed by periodic amendments and revisions of the "Clean Water" and "Clean Air" acts. The most important of these came in the 1965 with the Motor Vehicle Air Pollution Control Act, which gave the Government the authority to control emissions from motor vehicles.

In this spate of legislation there now arose a new theme that was to have important consequences for the Bureau's program. The theme was consumer protection. Of course, the Federal Government had a long history of protecting the economic and

---

<sup>13</sup> Johnson quoted in Kearns, *Lyndon Johnson*: 251.

physical safety of consumers. In 1872, Congress made it a crime to use the mails to defraud the public, and in 1887 the Interstate Commerce Commission was formed to regulate interstate carriers: railroads, barges, buses, and trucks. Most notable among this class of laws was the Pure Food Act passed in 1906 to regulate food, drugs, medicines and liquor. In support of this act, specific language in the Department of Agriculture's appropriations law allowed the Bureau of Animal Industry to regulate the cattle and other livestock industries. Catalyzed by the publication of Upton Sinclair's dramatic novel *The Jungle*, with its exposure of horribly unsanitary conditions in the Chicago stockyards, these laws were the first to protect consumer health.

However, between those early years and the New Deal years, there was little progress in consumer protection. In 1911, the Supreme Court ruled that the 1906 Pure Food Act did not prohibit false therapeutic claims. In 1912 Congress responded by passing the Sherley Amendment, which specifically forbade such deceptions. Other notable events during this period were the establishment in 1914 of the Federal Trade Commission (FTC), formed to prevent unfair or fraudulent trade practices, and the Food, Drug, and Insecticide Administration in 1927. Later known simply as the Food and Drug Administration (FDA), this agency took over the administration of the Pure Food Act from the Department of Agriculture's Bureau of Chemistry. During the New Deal years, under the advocacy of Assistant Secretary of Agriculture Rexford G. Tugwell, consumer protection in the sphere of food and drugs again became an issue. The main point of contention between manufacturers and advocates of consumer protection was the prohibition of false advertising. Consumer advocates wanted advertising held to the same standards as package labels. However, their legislative proposals went nowhere until jurisdiction over advertising claims was transferred from the FDA to the more cooperative FTC, and until 107 persons died tragically from taking a solution of sulfanilamide in the poisonous diethylene glycol, advertised as an "elixir." These two events set the stage for the passage of the Federal Food, Drug, and Cosmetic Act in 1938.<sup>14</sup>

Although there were two consumer protection laws passed in the early fifties—the Flammable Fabrics Act in 1953, and the refrigerator safety devices legislation in 1956 requiring safety devices on household refrigerators—new consumer-protection legislation did not arise as an important issue until the early sixties. Then, partly as the result of a more complex marketplace with new, unknown, and dangerous products, and partly, one can hypothesize, as the result of the emergence of an affluent society whose members had the leisure to be concerned with such issues, consumer protection became good politics. Thus, in 1962, President Kennedy sent to Congress a consumer message enunciating four "consumer rights": the right to safety, the right to choose, the right to be informed, and the right to be heard. This initiated a custom of yearly presidential consumer messages that lasted well into the Nixon years. Kennedy also formed the Consumer Advisory Council as part of the Council of Economic Advisors, composed of persons outside the Government. President Johnson made this council

---

<sup>14</sup> Mark V. Nadel, *The Politics of Consumer Protection* (Indianapolis: Bobbs-Merrill, 1971): 16-19.



part of the President's Committee on Consumer Interests, composed of high-level Government officials and designed to coordinate consumer issues in the Government. It was headed by a special assistant to the president, a newly created post first occupied by Esther Peterson. Consumer interests were now represented at the highest levels of the Executive Branch.

Consumer advocacy was not limited to the president. In the Congress, a number of members—all northern Democrats—also became advocates. Senators Philip Hart, Warren Magnuson, Joseph Montoya, Gaylord Nelson, Walter Mondale, Paul Douglas, William Proxmire, and Abraham Ribicoff, and House members Thomas Foley, Benjamin Rosenthal, Richard Ottinger, Harley Staggers, Leonor Sullivan, and Neil Smith all became champions of consumer causes.<sup>15</sup>

In 1964 legislation was passed that required vehicles purchased by the Government to pass certain passenger safety standards. However, in order to make consumer protection an important congressional issue, a “breakthrough” was needed. In a manner reminiscent of the events that occurred sixty years earlier with the publication of *The Jungle*, Ralph Nader catalyzed the Nation's interest in automobile safety with the publication of *Unsafe At Any Speed* in late 1965. Nader's book identified known design flaws in automobiles as the cause of traffic accidents. When it was learned that General Motors was investigating Nader's personal life, the book became a best seller. Both houses of Congress, which had been holding hearings on automobile safety, quickly joined forces and passed the important National Traffic and Motor Vehicle Safety Act of 1966.<sup>16</sup> The act gave the secretary of commerce authority to set minimum safety standards for automobiles, including standards for brake fluid and tires. On the same day, the Highway Safety Act of 1966 was also passed.

As if flood gates had been opened, a rash of new consumer safety legislation was passed in the next few years:

- The Department of Transportation Act in 1966 established the department, took over all transportation safety regulatory authority, and formed the National Transportation Safety Board, which was given authority to investigate all transportation accidents and report recommendations to the secretary of transportation. Its members would become fixtures in the investigation of aircraft accidents.
- The Clinical Laboratories Improvement Act of 1967 required that laboratories be licensed and operated in accordance with standards designed to assure consistent performance of accurate laboratory procedures and services.
- The Natural Gas Pipeline Safety Act of 1968 provided for Federal safety standards for the transportation of natural and other gas by pipeline and for pipeline facilities.
- The Fire Research and Safety Act of 1968 amended the Organic Act of the National Bureau of Standards and authorized a fire research and safety program.
- The Child Protection Act of 1966 banned hazardous toys and articles intended for children, and other articles so hazardous as to be dangerous in the household.

---

<sup>15</sup> Ibid., 108-109.

<sup>16</sup> Ibid., 137-143; *National Traffic and Motor Vehicle Safety Act of 1966, U.S. Statutes at Large* 80, (1966): 718.



Ralph Nader, consumer advocate, critic of automobile safety standards, and author of *Unsafe At Any Speed*, sat motionless in Washington traffic in 1970. (AP-Wide World Photos)

- The Child Protection and Toy Safety Act of 1969 expanded the 1966 law and included mechanical, electrical, and thermal hazards.
- A Joint Resolution on November 20, 1967, established the National Commission on Product Safety.
- The Flammable Fabrics Act, amendment of 1967 amended and extended the Flammable Fabrics Act of 1953.
- The Radiation Control for Health and Safety Act of 1968 reduced the exposure of the public to all unnecessary hazardous radiation from electronic products.

These laws showed a widening Government concern for consumer protection. Whereas previous legislation had been primarily concerned with foods, drugs, and cosmetics, the new laws were concerned with a wide variety of products, from toys and apparel to motor vehicles. And old areas were not overlooked. In 1967, the Wholesome Meat Act was passed, followed in 1968 with the Wholesome Poultry Products Act. Both stiffened existing laws.

Finally, the Government interest was expanded beyond safety to economic protection with the passage in 1966 of the Fair Packaging and Labeling Act and in 1968 of the Consumer Credit Protection Act, which required the disclosure by the lender of all costs associated with repayment of loans. While the total effect of these consumer laws did not match the momentous impact of the medicare and civil rights acts, they formed a notable part of the Great Society and initiated new duties for NBS.

## TECHNOLOGICAL TRIUMPH AND DRAMA

While thousands watched in person and millions more watched via television, on Wednesday, July 16, 1969, at 9:32 a.m. EDT, Apollo 11 blasted off from Cape Kennedy. Carrying astronauts Neil A. Armstrong, Edwin E. Aldrin, Jr., and Michael Collins, Apollo 11 was launched in an attempt to achieve President Kennedy's goal of "landing a man on the moon and returning him safely to earth." After a flawless three-day journey, the command ship and its attached lunar module went into orbit around the moon. Eleven orbits and some twenty-two hours later, Armstrong and Aldrin crawled into the spidery lunar module. On the twelfth orbit they separated the lunar module from the command/service modules. The astronauts made another orbit in the lunar module and then began their descent to the Sea of Tranquility. At 4:17 p.m. EDT on Sunday, July 20, 1969, Armstrong announced to mission control, "Houston, Tranquility Base here. The Eagle has landed." Six hours later, while millions throughout the world stared captivated at the somewhat fuzzy television images, Armstrong descended the lunar module's ladder, stepped onto the powdery surface of the moon, and uttered the now-famous words, "That's one small step for man, one giant leap for mankind." Twenty-one and a half hours later, after emplacement of a U.S. flag and scientific equipment, the astronauts blasted off the Moon. Docking with the orbiting command/service modules was readily accomplished, and two and a half hours later a course was set for home. Splashdown took place on July 24 at 12:50 p.m. EDT—eight days and three and a half hours after launching. It seemed too easy.

## THE RISE OF RELEVANCE

When President Johnson took office, science was in its glory years. Funds for research were plentiful and science stood high in the eyes of policy makers and the general public. Between 1956 and 1966, helped of course by the sputniks and the "space race," Federal Government funds for research and development, grew from \$17.3 billion to \$40 billion in constant 1982 dollars. This whopping increase meant an annual average growth rate over those years of 9.8 percent. While not increasing as rapidly, industrial support for R&D over the same period nearly doubled—from \$11.9 billion to \$21 billion, for an annual growth rate of 6.5 percent. The total funding, which included university and non-profit funds, reflected these figures, increasing from \$29.8 billion to \$62.6 billion, or an annual growth rate of 8.6 percent. The figures for basic research are even more dramatic. For the same period, Federal Government support of basic research showed an average growth rate of 18 percent. Industrial support of basic research grew by an annual average of 5.5 percent. It was the continuation of a trend started at the end of World War II. Everything seemed rosy for science and technology.

However, the trend did not last long. In the next ten years things changed drastically. Between 1966 and 1976, Federal Government R&D expenditures (in constant dollars) *decreased* from \$40 billion to \$31.8 billion, yielding a growth rate over those years of *negative* 2.5 percent. While not quite so drastic, total U.S. funding also dropped. Industrial funding, while not dropping, slowed significantly to an annual

growth rate of 3.3 percent. Funding specifically earmarked for basic research mirrored these results.<sup>17</sup> It was as if the brakes had been suddenly applied to a speeding truck. What happened?

Public support for science dwindled during the decade 1966-1976 for a complex set of reasons. A review of the decade, however, suggests that three forces dominated the crunch on Federal support of science and technology. One issue was the enormous financial drain of the Vietnam War. A second was a gradual fading in the public perception of science as a panacea for social ills. A third force could be characterized as "show me that your science has a rapid payoff."

Since the end of World War II, before things changed in 1966-1967, science had been in ascendancy. It was generally viewed as a benevolent activity, very helpful if not crucial to the social and economic well-being of the Nation. Furthermore, according to a commonly accepted belief the key to the productivity of science was basic research. Basic research, it was thought, would provide the "advances that would sustain the pace of inventions and applications."<sup>18</sup> But there could be a long lead time between basic advances and the resulting benefits, and few institutions could make such a long-term investment. The one organization with sufficient resources and time was the Federal Government. Hence the Government needed to be the principal supporter of basic research. And the Government had its own needs for science, particularly in the military and in space, so it would also carry applied research and development. These basic research, applied research, and development activities were viewed as more or less automatically leading to new products and better lives for us all.

Who was to decide what basic research to carry out? The prevalent view was expressed in 1959 by a White House panel on high energy physics:

It is not possible to assign relative priorities to various fields of science. Each science, at any given time, faces a critical set of problems that require solutions for continued growth. Sometimes these solutions can be acquired at little cost; sometimes larger expenditures of funds are needed. Hence the cost may not reflect the relative value but rather the need. Each area must be funded according to these needs.<sup>19</sup>

And what is to determine the size of the research budget? Speaking before Congress in 1964, Lee A. DuBridge stated, "It is adequate when, and only when, every competent research scholar in our universities is finding adequate support for the research program he is able to carry out."<sup>20</sup>

---

<sup>17</sup> *National Patterns of R&D Resources: 1987* (Washington, D.C.: National Science Foundation, 1988). The changes are more startling than described above. Funding generally rose until 1967, then dropped to a minimum in 1975. The figures for those years makes the changes seem more dramatic than for the equal ten-year periods chosen, but do not affect any conclusions.

<sup>18</sup> Bruce L. R. Smith, *American Science Policy Since World War II* (Washington, D.C.: The Brookings Institution, 1990): 36.

<sup>19</sup> D. S. Greenberg, "Money for Research: LBJ's Advisers Urge Scientists to Seek Public Support," *Science* 156 (May 19, 1967): 920.

<sup>20</sup> DuBridge quoted in Greenberg, "Money for Research": 920-921.

When Johnson assumed office in 1963, this “bottoms up” model in which new advances welled up out of the laboratories of researchers pursuing their own scientific ends, controlled only by peer pressure and peer review, seemed to have worked quite well. The Nation was the unquestioned technological leader of the world; its industrial productivity far surpassed that of any other country.

With the expansion of the Vietnam War came austerity and divisions within the society at large that carried severe consequences for the scientific community. The cost of the war was an enormous drain on the Treasury. Faculty and student protests against ROTC units and military research on campuses led to a split between liberals and conservatives in the scientific community. In-house dissent was matched by the layman’s disenchantment with science. Books like Rachael Carson’s *Silent Spring* and Ralph Nader’s *Unsafe At Any Speed* convinced many that science did not automatically lead to beneficial results.

These changes had a profound effect on President Johnson. He was reputed to have “cursed the ‘draft dodgers’ who hide in graduate school while seeking advanced science degrees . . . and [to have] ‘hit the roof’ when George B. Kistiakowsky, who served as science advisor to former President Eisenhower, severed his long-standing advisory ties with the Defense Department in protest over Vietnam [*sic*].”<sup>21</sup> A politician to the core, the president could not understand the attitude of scientists who took Government funds for research and at the same time criticized the policies of his administration. He had problems with which he needed help. He had a war to fight and a Great Society to build in the midst of burning cities, protest demonstrations, and campus unrest. Why could not science be directed to solve these problems? He made his feelings clear when, on October 15, 1966, speaking at the dedication of the Institute of Medicine, he stated, “A great deal of research has been done. . . . But I think the time has now come to zero in on the targets to get our knowledge fully applied. . . . Presidents, in my judgement, need to show more interest in what the specific results of medical research are during their lifetimes, and during their administrations.”<sup>22</sup>

The new position of science was forcefully articulated by Donald F. Hornig, who had been appointed science advisor by Kennedy and served throughout the whole Johnson Administration. Speaking before the American Physical Society on April 26, 1967, he said:

The scientific community is going to have to learn to articulate its hopes, to describe the opportunities which are before us for practical advance, to express the excitement of the new intellectual thrusts—but to do these in terms which the American people, who are expected to pay the bill, will generally understand and have faith in. There is no alternative.<sup>23</sup>

<sup>21</sup> Philip M. Boffey, “The Hornig Years: Did LBJ Neglect His Science Adviser?” *Science* 163 (January 31, 1969): 454.

<sup>22</sup> Johnson quoted in Smith, *American Science Policy*: 75.

<sup>23</sup> “Hornig on Research Policy: Public Understanding Essential to Scientific Progress,” *Science* 156 (May 5, 1967): 629.



Donald F. Hornig was appointed science advisor to President Kennedy and remained in that position throughout the Johnson Administration. In this photograph (1966), Hornig (left) reported to President Johnson on his recent visit to Europe. The Europeans had acknowledged a “technological gap” between that continent and the United States. (UPI/Corbis-Bettmann)

While implying no decreased interest in basic research, Hornig continued, “We are determined that the knowledge and understanding we have gained from science will be put to use to meet the needs of our people and the world as expeditiously as possible. . . . To this end the Federal Government supplies research and development funds where the results are technically feasible and economically or socially worthwhile.”<sup>24</sup>

Two years later, DuBridge, appointed science advisor by President Nixon, had much the same message:

The day is past when scientists and other scholars can sit quietly in their ivory towers unaware of and unconcerned with the world outside their laboratories. Science is now a part of society, is a part of politics, is a part of the social and economic system. Scientists must carefully ponder the relevance of their work to the problems of human beings, and they must ponder the ways in which this relevance can be clearly explained to the public at large. . . .

The members of Congress are apparently not convinced that the continued growth and virility of basic science in this country is essential to the national interest, and to the national welfare.”<sup>25</sup>

<sup>24</sup> Ibid.

<sup>25</sup> DuBridge quoted in Robert Reinhold, “Scientists Urged to Stay Relevant,” *New York Times*, November 2, 1969.

It was not only the administration that determined the new course for science funding. The Congress took action as well. In complementary bills, Congressman Emilio Q. Daddario and Senator Edward M. Kennedy introduced legislation to revise the charter of the National Science Foundation. The two bills were combined and signed into law by President Johnson on July 8, 1968. The most important new authority given to the NSF was to conduct applied as well as basic research. The crucial phrases read, "the Foundation is authorized to initiate and support scientific research, including applied research, at academic and other nonprofit institutions. When so directed by the President, the Foundation is further authorized to support, through other appropriate organizations, applied scientific research relevant to national problems involving the public interest."<sup>26</sup> In response to this, the Foundation formed the Interdisciplinary Research Relevant to the Problems of our Society Program in 1969. A new era of scientific relevance had begun.

In the midst of these tribulations, new and important advances were made in all the fields of basic science and in technology as well. In astronomy, for example, Arno A. Penzias and Robert W. Wilson discovered background radiation that had filled the universe since about 300 000 years after the "big bang," when matter and radiation were decoupled. Now cool, the radiation corresponded to a temperature of about 3 K, as predicted by theory. Penzias and Wilson's discovery occurred in 1964. Two years later, Raymond Davis, Jr., opened a "neutrino observatory" deep in South Dakota's Homestake gold mine. With a telescope that consisted of a 100 000 gallon tank of perchloroethylene, the instrument was designed to detect neutrinos by their conversion of chlorine-37 to argon-37.

In biology, Charles T. Caskey, Richard E. Marshall, and Marshall Nirenberg showed in 1967 that "identical forms of messenger RNA are used to produce the same amino acids in bacteria, guinea pigs, and toads, suggesting that the genetic code is a universal system used by all life forms."<sup>27</sup>

Two massive installations were established to study particle physics. On the West Coast, the Stanford Linear Accelerator Center went into operation in 1965, and in Batavia, Illinois, the Fermi National Accelerator Laboratory was established in 1969. In theoretical particle physics, Steven Weinberg, Abdus Salam, and Sheldon Glashow independently showed how two forces, the weak and the electromagnetic, could be unified. Called the electroweak theory, it offered insight into the fundamental laws of nature.

The premier technological accomplishments came as part of the space race. Step by carefully planned step, the United States worked its way to Apollo 11 and the moon landing. While never landing a man on the moon, the Soviet Union preceded the United States in some of the forerunner experiments. Both nations sent several space probes to Venus, and the United States sent two Mariner probes close to Mars. All were examples of technological virtuosity.

---

<sup>26</sup> *National Science Foundation Act of 1950, amendments, U.S. Statutes at Large*, 82 (1968): 361.

<sup>27</sup> Alexander Hellemans and Bryan Bunch, *The Timetables of Science* (New York: Simon and Schuster, 1988): 554.

Yet while these space spectacles were dramatic and newsworthy, other space advances were of more immediate use to the public. In 1965, an Early Bird satellite went into synchronous orbit around the earth, and real time communication between all points on earth was at hand. Then an Environmental Science Services Administration (ESSA) weather satellite went into polar orbit so that all parts of the globe could be observed. Weather patterns and their movements were to become a constant feature of television news broadcasts and their prediction of severe weather conditions were to add considerably to public safety.

In 1969 a development occurred that strikingly extended the capabilities of the normal research laboratory. In that year the scanning electron microscope became a practical laboratory instrument. A new dimension was added to the views of the microscopic world.

### TOWARD A NEW LEADERSHIP

As its institute structure was put in place in early 1964, NBS was in the middle of a period in which its direct appropriations grew substantially. The Bureau had also significantly increased the amount of basic research it was performing and, most importantly, had enriched its staff with new, vigorous scientist-leaders. Now it could look forward to busy years for the remainder of the decade with an impressive array of tasks before it. It had to learn how to manage a new organization and to develop it into a smoothly functioning entity. It had to complete the construction of its new home in Gaithersburg and the relocation of all of its Washington laboratories. Since the formation of the institutes, it had already acquired a new set of functions and would acquire more. In the introduction to the 1965 Annual Report, Director Astin labelled the Bureau "An evolving institution." He wrote:

The exponential growth of U.S. scientific and technological activity has increased the Bureau's workload in measurement and related fields many fold. At the same time, several new responsibilities have recently been assigned to it.

Among these are:

- To serve as the focal point within the Federal Government for stimulating the application of science and technology to the economy. . . .
- To set up and operate the National Standard Reference Data System. . . .
- To establish and expand a Clearinghouse for Federal Scientific and Technical Information. . . .
- To set up and operate a central technical analysis service to conduct cost-benefit studies for our own, and other Commerce bureaus and Federal agencies on request.
- To establish a central and major Government resource in the automatic data processing field. . . .<sup>28</sup>

<sup>28</sup> Annual Report for 1965: 2.



In combination with its traditional activities, these new functions—all dictated within the Executive Branch and some by the Bureau itself—would have filled the Bureau's plate to overflowing. But then, from the Legislative Branch came a whole new set of mandates—mostly concerned with public safety—that would sorely strap the Bureau's abilities to carry out their demands. These were the National Traffic and Motor Vehicle Safety Act of 1966, the Fair Packaging and Labeling Act, the Fire Research and Safety Act of 1968 (a law sought by the Bureau), the Flammable Fabrics Act, amendments, the Standard Reference Data Act (also sought by the Bureau), the Metric System Study, the Federal Property and Administration Services Act of 1949, amendment (the Brooks Act) in 1965 to include automatic data processing equipment, and the Radiation Control for Health and Safety Act of 1968. The Bureau, which since 1901 had basically lived with one piece of authorizing legislation, was now involved in carrying out the dictates of eight new laws.

During the period covered in this chapter, the Bureau decreased in size. In 1965 the Central Radio Propagation Laboratory, a part of the Bureau for twenty years, was transferred to the Environmental Science Services Administration, although the CRPL continued to occupy its quarters in Boulder. By the end of the period, all of the old-guard leaders, who had been with NBS since before World War II and had guided it through those trying war and post-war years, had retired from the Bureau. They were replaced by a new, equally dynamic set of younger leaders. It was truly a time of evolution for the institution.

#### **BUDGET, PERSONNEL, AND MANAGEMENT MATTERS**

In the years 1966 to 1976, Federal research and development budgets showed a reversal from the healthy increases experienced in the immediate post-sputnik years. A peak in overall Federal R&D expenditures occurred in 1966-1967, and funding (in constant dollars) then decreased until 1975. This was not the case for the Congressional appropriation for NBS. While not increasing at the high rates of the early sputnik years, its appropriation continued to increase in the period 1964 to 1970. However, there is more to this increase than meets the eye.

Total Congressional funds to NBS, in constant 1972 dollars, increased for the period, except in 1966. The decrease in 1966 was not a per capita decrease because it was occasioned by the divestiture of the CRPL. Figures for an analysis of the Bureau's support are shown in Appendix A, Table 3.<sup>29</sup> The table gives four columns of figures for the years 1961-1970. The first column is the Research and Technical Services (RTS) appropriation in current dollars. This is the appropriation allowed by the Congress for the Bureau's base program. It does not include such items as the special foreign currency program, the short-lived Civilian Industrial Technology (CIT) program, or other special programs.

---

<sup>29</sup> These figures are taken from the Annual Reports.

It also does not include income produced by the sale of Standard Reference Materials (SRMs) or from calibration charges. The second column lists the same figures in constant 1972 dollars.<sup>30</sup> The third and fourth columns give other appropriated and non-appropriated funds available to the Bureau and do include special foreign currency, CIT, Federal agency and non-federal funded research and development, calibration, and SRM income, etc., in current and constant 1972 dollars, respectively.

All the columns show a precipitous drop between 1965 and 1966, but this decrease is illusory and has only to do with the divestiture of the CRPL. While total Federal funds for research were showing a decrease, the Bureau was receiving an increase in real inflation-adjusted dollars, at least for inflation as measured by the GNP.

That the story is made somewhat more complex by the employment figures for the period as shown in Appendix A, Table 4.<sup>31</sup> The five columns shown are: Full-Time Permanent (FTP); Other Staff which includes post doctoral associates, summer help, part-time employees, temporary employees, and consultants; Total Paid Staff, which includes FTP and Other Staff; Research Associates and Guest Workers; and Total NBS Staff. In 1965 total employment reached 4793, approximately the same as the Bureau's previous high achieved during the Korean War before the divestiture of the ordnance work. The present high also occurred just before a divestiture, but in this case, the total personnel decrease was slightly over 650 as compared to the 2000 of the ordnance divestiture.

Most interesting is the number of FTP employees—the core of the Bureau's staff. After showing a rise of 525 between 1962 and 1965, followed by a drop of 433 upon the divestiture, there was a steady decline of about 200 employees over the next five years, while other paid and non-paid workers showed small increases. That this should happen when the Bureau appropriations were increasing at slightly over the inflation rate implies that the inflation rate for science was greater than in the general economy. However, it was during this period that, in order to decrease spending in the Government, controls were placed periodically on hiring, total permanent employment, average grades, and expenditures such as travel. These controls affected mainly the size of the full-time permanent staff and came at a time when the Bureau was receiving a host of new responsibilities. It was not a good trend for long-range institutional health.<sup>32</sup>

\* \* \*

---

<sup>30</sup> Data for the conversion to constant 1972 dollars are from the *Economic Report of the President Transmitted to the Congress*, February 1998.

<sup>31</sup> These figures are taken from the Annual Reports.

<sup>32</sup> Three documents among many others illustrate the nature of these controls: (1) Memorandum, A. V. Astin to Institute Directors, Associate Director for Administration, and Manager, Boulder Labs, "Moratorium on appointments and promotions to the GS-14 and higher grade levels," December 19, 1964. (NIST RHA; Director's Office; Box 381; Folder 11/1/64-12/31/64); (2) Memorandum, I. C. Schoonover to Institute Directors, Associate Directors, Division and Office Chiefs, "Freeze on Employment," October 4, 1966. (NIST RHA; Director's Office; Box 380; Folder Chrono File, Sept. & Oct. 1966) This memo begins: "As most of you know the President has directed agencies to hold employment in full-time permanent positions for the remainder of fiscal year 1967 to a level at or below that prevailing as of July 31, 1966." (3) Memorandum, A. V. Astin to J. H. Hollomon, "Employment Versus Ceilings," January 15, 1968. (NIST RHA; Director's Office; Box 386; Folder Chrono File 1/1/68-2/28/68)

When the institutes were formed in 1964, Irl C. Schoonover became deputy director of the Bureau, Robert D. Huntoon became director of the Institute for Basic Standards (IBS), Donald A. Schon became director of the Institute for Applied Technology (IAT), and C. Gordon Little remained head of CRPL. The Institute for Materials Research (IMR), however, had no director, although Schoonover acted as one. But Bureau management had a plan and a candidate. The plan was to bring in a senior person, well-established and well-known in the materials community, as director for a stay of a few years to get the new institute established and recognized. The candidate was Gordon K. Teal, at the time assistant vice president and international technical director of the semiconductor electronics giant Texas Instruments. Teal had been with Texas Instruments for eleven years and had built up a strong research capability, producing the first commercial silicon transistor and a chemical reduction process for the production of ultra-pure silicon. He had come to Texas Instruments from Bell Telephone Laboratories where he had produced the first high-quality single crystal germanium for use in transistors and, with Morgan Sparks and William Shockley, developed the junction transistor.<sup>33</sup> Astin and Patrick E. Haggerty, president of Texas Instruments, exchanged correspondence, and on December 12, 1964, Teal was appointed director of IMR.<sup>34</sup> Teal stayed three years and, during his tenure, built up a cohesive and renowned group. He also brought back Howard E. Sorrows from Texas Instruments as his special assistant. Sorrows, who began his career at NBS in 1941, would have great influence on Bureau management.

Bringing the new Bureau organization under control was to prove more taxing than the hiring of Gordon Teal had been but was to bring to the surface a cadre of new, young leaders. In due course, they would take over the leadership of the Bureau. A long series of personnel moves began when, in the spring of 1966, Schon announced his intention to resign his position as director of IAT effective July 1, to head a new non-profit organization that would study innovation.<sup>35</sup> John P. Eberhard, who had been IAT deputy director, was elevated to director, and Lawrence M. Kushner, another of the young Bureau leaders, left his position as chief of the Metallurgy Division to become Eberhard's deputy. With the departure of Teal at the end of 1967, another duo of young leaders arose. On January 2, 1968, Huntoon was reassigned from his position as director of IBS to chief of the Office of Program Development and Evaluation.<sup>36</sup> Ernest Ambler, of parity fame, was appointed director of IBS, and polymer scientist

---

<sup>33</sup> National Bureau of Standards press release, December 12, 1964. (NIST History Project File; Chapter 5; Folder Leaders)

<sup>34</sup> Letter, A. V. Astin to P. E. Haggerty, July 22, 1964. (NIST RHA; Director's Office; Box 381; Folder 5/64-8/64)

<sup>35</sup> Memorandum, A. V. Astin to J. H. Hollomon, "Director of the Institute for Applied Technology," March 30, 1966. (NIST RHA; Director's Office; Box 380; Folder Chrono 3-1-66 to 4-30-66)

<sup>36</sup> Memorandum, A. V. Astin to J. F. Kincaid, "Reassignment of Dr. Robert D. Huntoon from the position of Director, Institute for Basic Standards, GS-18, to the position of Chief, Office for Program Development and Evaluation, GS-18," January 2, 1968. (NIST RHA; Director's Office; Box 386; Folder Chrono 1-1-68 to 2-28-68)

John D. Hoffman was appointed director of IMR. Then, to complete the moves, Eberhard announced his resignation effective May 1, 1968, at which time Kushner took over his position.<sup>37</sup>

Preceding both these moves was an important one indeed. In 1967 J. Herbert Hollomon resigned his position as assistant secretary of commerce for science and technology to assume the post of president of the University of Oklahoma. He had stayed for more than five years and had brought significant changes to the Bureau. Hollomon was succeeded by the more relaxed John F. Kincaid, vice president for research and development of the International Minerals and Chemicals Corporation.



Assistant Secretary of Commerce for Science and Technology J. Herbert Hollomon, and wife, Margaret Hollomon (left), chatted with Representative Carl Albert (right) and Commerce Secretary Alexander B. Trowbridge at a reception honoring the departing Hollomons. (copyright Washington Post; reprinted by permission of D.C. Public Library)

<sup>37</sup> Memorandum, A. V. Astin to J. F. Kincaid, "Appointment to Directorships of the Institute for Basic Standards, the Institute for Materials Research, and the Institute for Applied Technology," January 19, 1968. (NIST RHA; Director's Office; Box 386; Folder Chrono File 1-1-68 to 2-28-68)

Then came the departure of two of the Bureau's grand old leaders. The senior scientist, Robert D. Huntoon, who had come to the Bureau in 1941, retired on July 30, 1968, and Irl C. Schoonover, who had come in 1933 and was now deputy director, retired in January 1969. Kushner was appointed deputy director of the Bureau, and Howard Sorrows was made acting director of IAT. At the end of the moves, all the major management positions at the Bureau, except that of the director and that of associate director for administration, Robert S. Walleigh's position, had been assumed by new, young leaders who had spent all or most of their careers at the Bureau. Kushner was deputy director of the Bureau; Ambler was director of IBS; Hoffman was director of IMR; and Sorrows was acting director of IAT. The stage was set for the final act: Astin's retirement on August 31, 1969. For this, Lewis M. Branscomb waited off-stage in Boulder.

For an organization in which tenure in senior positions had been measured in decades rather than years, these moves seemed tumultuous. In reality, they were caused by the resignation of two IAT directors and the aging of two senior leaders, Schoonover and Huntoon. Nor were these personnel moves the only ones. Of particular importance was the Boulder situation. All the Boulder divisions except those in the CRPL were placed in IBS, and Bascom W. Birmingham was named deputy director of IBS for Boulder. He was also named executive officer for the Boulder Laboratories, with the authority to "plan and supervise the administrative programs required to support the Bureau's scientific and technical program at Boulder" and to "act as the personal representative of the Director in all matters at Boulder requiring a spokesman."<sup>38</sup>

Not only was the period characterized by personnel moves. New types of organizational units—offices and centers—were formed as the need arose, and later, a new form of management called matrix management was initiated. Despite these changes, division chiefs were still the interface between upper management and laboratory scientists, and it was difficult for them to keep up with the changes.

\* \* \*

The enactment of the Civil Rights Act of 1964 threw the efforts to ensure equal opportunity throughout the whole Government into high gear, and the Bureau was no laggard. However, the first few years after the passage of the act were more a time of organizing for what would be a long campaign rather than actual accomplishment of major changes. The Bureau did not act autonomously; it had to coordinate its activities with those of the Department of Commerce (DOC) and the White House, and had to be consistent with the law. Thus, in late 1965, Astin, in response to Secretary Connor's request for the Bureau's plan for expanding EEO, announced his intention to form a two-man Office of Equal Opportunity. This office would report to Astin's assistant, George E. Auman, who would be named equal opportunity coordinator.<sup>39</sup> In the same memorandum, Astin announced a plan to appoint a qualified minority person as chief

---

<sup>38</sup> "Birmingham Appointed Executive Officer at Boulder," *Technical News Bulletin* 52 (March 1968): 53.

<sup>39</sup> Memorandum, A. V. Astin to J. T. Connor, "NBS plan for expanding equal employment opportunities," December 15, 1965. (NIST RHA; Director's Office; Box 381; Folder Nov. 1-Dec. 31, '65)

of one of the administrative divisions and pointed out that the situation with the technical divisions was far more complex because of the scarcity of trained African-American scientists and engineers. However, to "ensure affirmative action," he promised to evaluate the "potential value of increased training" for each minority person in grades GS-5 and above.

Until October 1967, Auman carried all the EEO functions. At that time, new appointments were made. In particular, Donald G. Fletcher was appointed deputy equal employment opportunity officer, a post required by Executive Order.<sup>40</sup> Now things began to get more systematic. In early 1968, Astin asked the Bureau's personnel officer to form an advisory committee composed of minorities and women which would meet with him quarterly to review progress in hiring.<sup>41</sup> This was the first Bureau EEO Committee. Shortly thereafter, in a memorandum to all employees, Astin established a contact person for anyone who had "experienced or observed acts of discrimination," and the procedures to be followed for responding to discrimination occurring outside the Bureau.<sup>42</sup> In early 1969, the EEO Committee, which had advised the personnel officer, was changed. The new nine-member committee was placed under the chairmanship of chemist Avery T. Horton. The committee advised top management directly "concerning programs which must be undertaken to make equal employment a fulfillment rather than a promise." At the same time an affirmative action plan covering "recruitment, training, information dissemination, skills utilization surveys, and all aspects of the incentive awards program" was adopted. Progress in execution would be monitored by the EEO Committee.<sup>43</sup> The Bureau finally had an EEO structure in place, but progress was slow.

Not only was the Bureau concerned with EEO within its confines, it also had to be concerned with possible discrimination in the surrounding community. In 1966, Astin and James A. Shannon, director of the National Institutes of Health, sent a firmly worded letter to Kathryn E. Biggs, President of the Montgomery County Council, to make her aware of their "concern over the need for more aggressive and positive action to make suitable housing available to all members of our staffs. . . ." The letter

---

<sup>40</sup> Memorandum, R. S. Walleigh to D. R. Baldwin, "Designations of Responsibility for Equal Opportunity Programs," October 12, 1967. (NIST RHA; Director's Office; Box 386; Folder Chrono Sept. 1 to Oct. 31, 1967)

<sup>41</sup> Memorandum, A. V. Astin to Deputy Director, Associate Director for Administration, Institute Directors, Director Center for Radiation Research, Division Chiefs, "Reaffirmation of Equal Employment Opportunity Policy and Practices," May 16, 1968. (NIST RHA; Director's Office; Box 386; Folder Chrono File May 1 Through June 30, 1968)

<sup>42</sup> For incidents within the Bureau, the contacts were Donald G. Fletcher and Karl E. Bell, both blacks, and Robert F. Bain. For incidents outside the Bureau, a written complaint was to be lodged with the executive secretary of the County Commission on Human Relations. Memorandum, A. V. Astin to All Employees, "Equal Opportunity," July 12, 1968. (NIST RHA; Director's Office; Box 386; Folder Chrono File 7/11/68 thru 8/31/68)

<sup>43</sup> "NBS Moves to Insure Equal Opportunity For All Employees," *NBS Standard* 14 (June 1969): 1.

continued,

It is essential that we be able to assure prospective employees that they and their families will have full and equal opportunity to participate in the economic, social, educational and cultural life of our community, State and Nation. It is equally imperative that such assurance be afforded our present employees, so that we may retain both quantity and quality of personnel. Their employability must not be hindered by customs, traditions, and practices which would deny them the opportunity to enjoy the natural benefits of their earnings. . . .<sup>44</sup>

By mid-1968 Montgomery County, Maryland, had a Public Accommodations Ordinance applicable to all places of public accommodation to ensure their use without discrimination.

### THE PLANNING-PROGRAMMING-BUDGETING SYSTEM

At a news conference on August 2, 1965, President Johnson told of a new administrative system about to be installed in the Federal Government.

This morning," he said, "I have just concluded a breakfast meeting with the Cabinet and with the heads of Federal agencies and I am asking each of them to immediately begin to introduce a very new and very revolutionary system of planning and programming the budgeting throughout the vast Federal Government, so that through the tools of modern management the full promise of a finer life can be brought to every American at the lowest possible cost."<sup>45</sup>

What the President was talking about was installing in the Federal Government a Planning-Programming-Budgeting (PPB) system. Generally thought to have been born in the Department of Defense in the early sixties, PPB had, in fact, a much longer history.<sup>46</sup> It was an activity intended to coordinate the planning of agency programs with the budgeting necessary to achieve the objectives of those programs. Installed in every agency, it was expected to give the President, through his Bureau of the Budget (BOB), greater input into the budgeting process. It was to have a profound effect on Government management systems.

Two months later, BOB issued to all agencies Bulletin 66-3, which explained what had to be done to install the new system.<sup>47</sup> It set target dates, culminating on May 1, 1966, when the system would be essentially installed. Managers in the Federal Government hurriedly began attempting to implement the system.

<sup>44</sup> A draft of this letter dated 9-1-66 is attached to: Memorandum, A. V. Astin to J. H. Hollomon, "Issuance of Joint NIH-NBS Statement on Open Housing," September 1, 1966. (NIST RHA; Director's Office; Box 380; Folder Chrono File Sept. & Oct. 1966)

<sup>45</sup> Johnson quoted in "The Origin and History of Program Budgeting," in *Program Budgeting: Program Analysis and the Federal Budget*, David Novick, ed. (Cambridge: Harvard University Press, 1967): xv.

<sup>46</sup> Novick, *The Origin and History of Program Budgeting*, xvi-xxi.

<sup>47</sup> Executive Office of the President, Bureau of the Budget, *Bulletin No. 66-3*, October 12, 1965. Revisions were made in 1967 (Bulletins 68-2, 68-3) and in 1968 (Bulletin 68-9).

Essential to the system was a program structure which reflected each agency's objectives. Included in this structure was an analysis of alternative objectives and alternative programs which could meet those objectives. An analysis would compare the costs and the benefits of the alternative programs.

It was clear to the Bureau that this new system required a major staff effort. In 1966, the Bureau opened an Office of Program Development and Evaluation, but it remained vacant for some time. Most of the work was apparently carried out by the institute offices, with Astin's long-time associate George Auman the focal point in the director's office. In 1967, Huntoon took over the Office of Program Development and Evaluation in an acting capacity, joined in 1968 by Merrill B. Wallenstein and Robert E. Ferguson. By 1969 Ferguson became Astin's special assistant for program planning. A program office of this kind would continue to exist far into the future—even after it was no longer directly associated with PPB—and would have a major impact on the Bureau's management operations.

The development of a program structure to describe the Bureau's work was not accomplished immediately. All-day meetings were held among Astin and his top leaders. Proposed program categories and program issues were communicated to Assistant Secretary Hollomon.<sup>48</sup> By April 1, the deadline for submitting the program financial plan, the Bureau's programs had been segregated into three PPB categories: "advancement of industry and commerce" with three subcategories, "basic measurement system" with four subcategories, and "general administration and special services," with two subcategories.

In June 1966, Astin sent Hollomon a memorandum to be used in briefing the secretary on the FY 1968 budget—the first budget developed using the PPB system.<sup>49</sup> The Bureau's base RTS appropriation was initially broken up among the three PPB categories given above, but eventually a program structure containing just two categories—the physical measurement system and general administration and special services—was agreed upon and used for the preparation of a PPB analysis.<sup>50</sup> It proved difficult to apply the principles of the PPB system to NBS. Despite considerable effort, the system seemed overly complicated and not very helpful to management.

The PPB system as a Government-wide activity disappeared in the early 70s, but it left an important legacy. The agencies of the Government had set in place a structure for the justification of new and existing programs, and this was not easily abandoned. In science, it was now the age of relevance, and agency programs had to be justified on the basis of their value to the agency's customers, using such techniques as cost-benefit analysis for these justifications. The Bureau itself had now set up a Program Office to assist the director in deciding which of the programs sponsored by the institutes, centers, and divisions should be pursued. Gone were the days when a

<sup>48</sup> A. V. Astin to J. H. Hollomon, "Revision of NBS Planning-Programming-Budgeting Categories," January 21, 1966; A. V. Astin to R. D. Huntoon, Teal, Schon, "Definition of NBS Program Category Structure," February 24, 1966. (NIST RHA; Director's Office; Box 380; Folder Chrono 1-1-66 to 2-28-66)

<sup>49</sup> A. V. Astin to J. H. Hollomon, "Briefing Memorandum," June 7, 1966. (NIST RHA; Director's Office; Box 380; Folder Chrono May 1 to June 30, 1966)

<sup>50</sup> A. V. Astin to J. H. Hollomon, "Program Memorandum and Program Financial Plan for Commerce Program Category V, The Physical Measurement System," June 12, 1967. (NIST RHA; Director's Office; Box 386; Folder Chrono May 1, 1967-June 30, 1967)



division chief in conference with the director decided what to do in the forthcoming year—science and technology had grown too big and too costly for such a manner of operating. While the PPB system proved unworkable, it was perhaps inevitable that some type of program analysis should have arisen.

### THE GAITHERSBURG RELOCATION

By the end of World War II, the Bureau facilities at the Van Ness site were on the verge of becoming totally inadequate. Already considered for major rehabilitation in the mid-thirties,<sup>51</sup> the physical plant had suffered greatly from overuse and lack of



Left: Demolition of the Industrial Building at the old NBS campus. (copyright Washington Post; reprinted by permission of D.C. Public Library)

Below: All that remains of the Bureau in Washington, D.C. is the Newton apple tree, a direct descendent of the tree said to have inspired Newton's first thoughts on the law of universal gravitation. On March 15, 1957, the NBS tree was appropriately planted beside the East Building where the force of gravity was soon re-measured with modern precision.



<sup>51</sup> House Committee on Appropriations, Subcommittee on Department of Commerce and Related Agencies, *Department of Commerce and Related Agencies Appropriations for 1957: Hearings Before a Subcommittee of the Committee on Appropriations*, 84th Cong., 2d sess., National Bureau of Standards, 20 March 1956: 139. This testimony is an almost verbatim repeat of: Memorandum, A.V. Astin to George T. Moore, "Policy Considerations, Relocation of the National Bureau of Standards," July 14, 1955. (NARA; RG 127; Astin Files; Box 35; Folder Gaithersburg Site and Relocation)

proper maintenance during the war. Indeed, William I. Ellenberger, newly appointed Plant Division chief shortly after the war, declared the facilities a "sordid mess." Not only did the buildings suffer from years of lack of proper care, but records of what had been built and the location of power, steam, water, and electrical lines had been lost.<sup>52</sup> In the early fifties, \$2 million were spent on "extraordinary maintenance to rehabilitate the electrical system," and by 1955 it was already showing inadequacies.<sup>53</sup> By 1956 the Bureau was completing a \$1.3 million program to rehabilitate the mechanical systems, but it was anticipated that because of their age the systems would require additional large expenditures to keep them in "minimum operating conditions."<sup>54</sup> Moreover, in its more than fifty years, the Bureau had grown manyfold, but the physical plant to accommodate all of its added responsibilities had grown haphazardly. In 1955, there were eighty-nine buildings at the Van Ness site, of which fifty-three were temporary structures. The average age of the permanent buildings was thirty years, and the temporaries had already largely exceeded their life expectancies. With this diversity of buildings, closely related research units were widely separated. The average division was scattered in eight buildings. Lacking the stimulation brought about by close association of related groups, the conglomerate was inefficient and managing it was a constant headache. Worse, what in 1901 had been a rural location had by the fifties become an urban one. A residential area of the city now surrounded the Bureau. Noise, electrical disturbances, air pollution, and the dangers in this setting associated with the potentially hazardous nature of some its own operations constrained the Bureau's freedom. A new rural setting was needed.<sup>55</sup> It is small wonder that in 1953 the second recommendation of the first Kelly Committee was the modernization of the physical plant.<sup>56</sup>

Added to these considerations was the newly formulated policy of dispersal. With the Van Ness site only 3.6 air miles from the White House, NBS was extremely vulnerable to atomic attack. In addition to the potential for loss of life, there was the possible loss of the national standards. Astin estimated that it would require more than ten years to replace the Bureau's laboratories and technical personnel if they were to be lost.<sup>57</sup> Thus in mid-1955 when James Worthy, assistant secretary of commerce for administration and a strong Bureau supporter in the AD-X2 affair, told Astin that the Bureau had been chosen as a possible agency for relocation and asked if he were interested, Astin answered "yes" with alacrity. Worthy asked Astin to obtain an estimate on how much the relocation would cost. There were only about two weeks left for the

---

<sup>52</sup> MFP, 503.

<sup>53</sup> Appropriations Hearings for 1957: 134.

<sup>54</sup> *Ibid.*

<sup>55</sup> *Ibid.*, 135.

<sup>56</sup> *A Report to The Secretary of Commerce by the Ad Hoc Committee for the Evaluation of the Present Functions of the National Bureau of Standards: A Report on the Present Functions and Operations of the National Bureau of Standards With Their Evaluation in Relation to Present National Needs and Recommendations for the Improvement and Strengthening of the Bureau*, October 15, 1953, Mervin J. Kelly, chairman: 19.

<sup>57</sup> Appropriations Hearings for 1957: 135.

preparation of the President's budget for FY 1957, so the Bureau asked the General Services Administration (GSA) for a rough estimate of the cost of such a relocation.<sup>58</sup> In retrospect, asking this of the GSA was a mistake that was to cause considerable discomfiture for the Bureau.<sup>59</sup> The GSA had plenty of experience with office buildings but little or none with laboratories. Their first estimate was for \$40 million, a figure which proved to be woefully and embarrassingly low.

Before any move could be contemplated the Bureau had to decide where it wanted to move. Bureau management was very conscious of the fact that the move of the CRPL to Boulder caused a loss of approximately 50 percent of the relevant senior staff and they wanted to make this new move as convenient for the employees as possible.<sup>60</sup> To decide what to do, a study was made of the residential distribution of the work force. The study found that the center of gravity of the whole staff was the Van Ness site itself, but for the professionals the center was farther out Connecticut Avenue, at Chevy Chase Circle on the Maryland-District of Columbia boundary. It was therefore decided that the move would be northwest into Maryland, as close as possible to the District of Columbia consistent with a rural location and with the dictates of dispersal. A distance of twenty miles from the center of Washington was deemed sufficient for purposes of dispersal. A move into the Washington-Baltimore corridor might have provided a rural setting, but this was ruled out by the administration as being a prime target area.<sup>61</sup>

It was estimated that a site of 500 acres was necessary to maintain isolation and allow for long-term expansion. Fortunately, as part of its own relocation to Germantown, Maryland, the Atomic Energy Commission (AEC) had recently had a number of sites investigated by the Public Buildings Service (PBS). For this agency, the Corps of Engineers had prepared a Site Investigation Report. Astin requested and received a copy of this report, and the Bureau investigated several of the listed sites. Besides the location and the size, other considerations were topography, accessibility by road and railroad (a requirement later removed), and cost. Aerial and topographic maps were studied by senior Bureau staff and several possibilities selected.<sup>62</sup>

The relocation plan was placed before the Congress on March 20, 1956, at the House Appropriations Committee Hearings for the FY 1957 budget. This was just nine months after Assistant Secretary Worthy had broached the subject with Astin. The figures on the cost of the relocation and the submission, prepared in July of the previous year, were greatly underestimated.

---

<sup>58</sup> A. V. Astin Oral History, July 12, 1983, p. 35.

<sup>59</sup> R. S. Walleigh, who took over direction of the relocation, was to state, "I think the biggest mistake we ever made in connection with the Gaithersburg planning was bringing GSA into it at all and if I had it to do over again I certainly would rather have kept them out of it." Astin Oral History: 44.

<sup>60</sup> *Ibid.*, 39.

<sup>61</sup> *Ibid.*, 40-41.

<sup>62</sup> "Summary of Files on Gaithersburg," 2.00: 1-2. (NIST Historical File). Prepared by the NBS Management Planning Division in May 1958, this document gives a summary of many of the files on Gaithersburg up to 1958. Not all of the original files cited in the summary were investigated for this history.

Now a reason for quick action arose. When the Senate reported on the FY 1957 appropriations bill, Senator Carl T. Hayden, chairman of the Appropriations Committee, wrote to Secretary Weeks on May 23, 1956, asking that a specific site be identified.<sup>63</sup> Thus, on May 24, 1956, Associate Director for Administration Robert S. Walleigh took Astin to see what he considered to be the best of the favored candidates. It was near the small, sleepy town of Gaithersburg, bounded by U.S. 240 (soon to become Interstate 70S and later renamed Interstate 270), State Highway 124, and Muddy Branch Road. It contained an estimated 575 acres of mostly open, quite level ground, and the area was relatively unpopulated. Proximity to tracks of the B&O railroad provided for the possibility of a spur (subsequently dropped because of cost) and also for commuter access via a station in Gaithersburg (again, never used). Astin chose the site, the selection was approved by Secretary Weeks, and the appropriations committees of both houses were notified.<sup>64</sup> The Bureau had taken the first tangible step toward finding a new home. It was to be a long road.

At that time, the Bureau was requesting \$2.75 million for preliminaries including soil tests, the site survey, purchase of the land, preparation of plans and specifications, general expenses, and contingencies. As of yet, no money was being requested for construction.<sup>65</sup> The committee was willing to help but was concerned with the cost. Perhaps with tongue in cheek, Chairman Prince H. Preston said to Astin at the beginning of the session, "Doctor, you had better put on your top hat and your patent leather shoes now, and give us a good sales talk on this one."<sup>66</sup> Later, after some figures had been presented, the following exchange took place:

MR. PRESTON: Naturally, our first reaction would be we feel it is a matter of national pride in having a splendid scientific laboratory set up for the Bureau of Standards, but at the same time, \$50 million is a large sum.

At this point, Congressman Albert Thomas of Texas uttered the prophetic and remarkably accurate words: "It will probably be 85 to 100 before you get through." Astin then returned to the Bureau's plans, "Mr. Chairman, I felt in terms of our responsibility, we should make some long-range plans for our program. . . . If they are shocking, then we are shocked, too."<sup>67</sup>

What the GSA had developed in response to Astin's original request was a plan which provided 1 million square feet of space (as compared to the Van Ness site's 840 000 square feet) in a six-story-plus-penthouse square building—the least expensive

---

<sup>63</sup> Ibid.

<sup>64</sup> Ibid., 3.

<sup>65</sup> Appropriations Hearings for 1957: 134-136.

<sup>66</sup> Ibid., 137.

<sup>67</sup> Ibid., 141. The reader will recall that this was a little more than a year and a half before the sputniks.

form of construction.<sup>68</sup> In addition to the cost of this building, there was \$750 000 for the land and further costs for a powerhouse, radioactivity building, nine miscellaneous buildings, underground vaults, parking, a cafeteria, protection equipment, roads, walks, a fence, a guardhouse, and street lights. Costs associated with design and construction supervision brought GSA's total to a round \$40 million.<sup>69</sup>

But these could not be the only costs associated with the relocation. There would be costs for equipage and moving. The GSA could not estimate these; that was a Bureau responsibility. Astin allowed, "We don't have any estimates on those. Those would come out of the study, but I don't know whether my budget officer would want to make a wild guess. . . ." Budget Officer Wilbur W. Bolton did not hesitate. "Without regard to special facilities that might be added to our building, our experience has been that equipage and moving costs may run 50 percent of the structure cost."<sup>70</sup> What the Bureau was asking for was \$2.75 million to begin the process of construction of facilities whose cost, arrived at partly by a suspect estimate and partly by a wild guess, was about \$60 million. The House voted no funds.

The Senate was more lenient. It voted to grant \$930 000 and the House concurred. This amount was transferred to the GSA "[f]or acquisition of necessary land and to initiate the design of the facilities to be constructed thereon for the National Bureau of Standards outside of the District of Columbia to remain available until expended. . . ." <sup>71</sup> The Bureau relocation effort was haltingly underway, but at least it was started.

With the appropriation in hand, the Bureau's management went into high gear. Nicholas E. Golovin, Astin's associate director for planning, was placed in charge of the relocation effort. Golovin worked closely with Robert Walleigh, who took over the assignment in May 1958. Two main problems were identified: the acquisition of the site, and the design of the laboratories. Two committees were formed. A Gaithersburg Planning Group with eight persons under Hylton Graham, chief of the Plant Division, provided liaison between the technical staff and the architects, and a Laboratory Planning Committee composed of outstanding younger scientists provided direct input from the scientific staff.<sup>72</sup>

---

<sup>68</sup> On July 7, 1955, the Bureau advised Fred S. Poorman of the GSA "that a wing-type structure similar to the Boulder Laboratory is desirable. Poorman seemed inclined towards a block-type structure with few windows, a high lighting level and air conditioning." "Summary of Files on Gaithersburg," 3.21: 3-4.

<sup>69</sup> Appropriations Hearings for 1957: 136.

<sup>70</sup> *Ibid.*, 139.

<sup>71</sup> *Department of Commerce and Related Agencies Appropriation Act, 1957, U.S. Statutes at Large*, 70 (1956): 321.

<sup>72</sup> Lewis M. Branscomb was chairman of the committee until he resigned in June 1959. John D. Hoffman replaced him. The other members of the committee were Herbert P. Broida, Alan D. Franklin, F. Ralph Kotter, Lawrence M. Kushner, and Leo A. Wall. (Memorandum, L. M. Branscomb to A. V. Astin, "Laboratory Planning Committee," June 19, 1959. Memorandum, A. V. Astin to J. D. Hoffman, "Chairmanship of the NBS Laboratory Planning Committee," August 31, 1959. (NARA; RG 167; Astin File; Box 35; Folder Gaithersburg Site and Relocation, 1955-61))



Robert S. Walleigh began his career at NBS in 1943 as an electrical engineer in the Ordnance Development Division. Walleigh's talent for management was recognized, and after promotion to assistant chief for administration of the Ordnance Division, in 1955 Walleigh was appointed associate director for administration of the Bureau as a whole. In the latter position, Walleigh expertly directed the planning, construction, and move of the Bureau's facilities from the District of Columbia to Gaithersburg, Maryland.

Having selected the site and received the appropriation, NBS left to the Public Buildings Service the actual mechanics of acquiring the land from its owners. Condemnation was the procedure followed to obtain the property. It was Astin's desire to file a declaration of taking as soon after July 1, 1956, as possible.<sup>73</sup> A survey was begun on July 18, and the completed boundary and topographic surveys were completed on September 13, 1956.<sup>74</sup> The declaration of taking was accomplished, and though the final price was not agreed upon, \$325 000 was deposited with the court. In January 1957, a number of appraisals had been made, and the land was valued at an average of \$850 per acre.<sup>75</sup> With money appropriated piecemeal by Congress, the final cost of the land was \$574 000, although this included twelve more acres needed to provide extra space around the reactor building, as required by the AEC. The final size of the site was 560 acres.<sup>76</sup>

<sup>73</sup> "Summary on Files of Gaithersburg," 2.00: 4.

<sup>74</sup> *Ibid.*, 6.

<sup>75</sup> *Ibid.*, 8, 10.

<sup>76</sup> House Committee on Appropriations, Subcommittee on Departments of State, Justice, Commerce, the Judiciary, and Related Agencies Appropriations, *Departments of State, Justice, Commerce, the Judiciary, and relatd Agencies Appropriations for 1967: Hearings Before a Subcommittee of the Committee on Appropriations*, 89th Cong., 2d sess., National Bureau of Standards, 14 March 1966: 711. The size was provided by the Plant Division in June 1992.

Of great immediate interest to the Bureau staff was the style of the whole emplacement and the facilities to be provided in the laboratories. In late 1956, the architectural firm of Voorhees, Walker, Smith, and Smith, a firm with experience in the design of laboratories, was retained for this preliminary phase. Input from the staff came from three sources: an attitude survey conducted in late 1956, the Laboratory Planning Committee and, of course, from the division chiefs.

The attitude survey showed that a campus-like atmosphere with more than one building was important in attracting scientists and engineers.<sup>77</sup> In fact, in a letter to the mayor of Gaithersburg on October 16, 1956, Walleigh wrote,

The Bureau wishes to develop on its new site a university-campus-type atmosphere similar to the one which has been achieved on the present site. It has been found that such surroundings are an asset in attracting and retaining scientists and in producing the environment which stimulates scientific productivity.<sup>78</sup>

A little more than a year later, the Laboratory Planning Committee wrote Golovin with the same sentiments, but the committee was not sure that such an atmosphere required a multi-building structure.

While it was a little early to decide completely the matter of services, the GSA recorded the following NBS requirements for all general-purpose labs: compressed air, vacuum, natural gas, oxygen, 110 volt and 208 volt alternating current, direct current, and other special voltages and currents in some cases.<sup>79</sup> Chemistry labs would in addition receive distilled water. And, as an important corollary to these services, it was urged by the Laboratory Planning Committee that the construction should be such that laboratories could be easily expanded at minimum cost. Other requirements communicated to the architects were that the property should be completely fenced, that a railroad spur to the site should be planned, and that while blast protection was not necessary, there should be personnel bomb shelter areas.

The architects visited Boulder since they had been told that it had the general character that the Bureau would want in the new site. Finally in December 1956 Astin and Golovin, meeting with the architects, agreed:

1. That probably a number of structures would be preferable to one or two large buildings.
2. That the general motif would be austere but austerity would not be carried to the point where additional costs would be involved.
3. The general atmosphere of the facilities would be that of a college campus and perhaps the general style of structure would be wing-type with adjacent parking areas. There will be many entrances rather than one or two.<sup>80</sup>

The last was a remarkably apt description of the site that resulted.

<sup>77</sup> "Summary of Files on Gaithersburg," 3.21: 1.

<sup>78</sup> Ibid.

<sup>79</sup> The general services finally distributed were cold water, hot water, laboratory waste drain, chilled water (55 °F), burner gas, compressed air, vacuum (20 in to 22 in mercury), steam (15 lbs), 120 V AC, 208 V AC single and 3 phase, and standard frequencies.

<sup>80</sup> "Summary of Files on Gaithersburg," 3.21: 5-6.

In January 1957, Astin, Golovin, Walleigh, and the architects visited laboratories at DuPont, Bell Telephone, Argonne, Midwest Research Institute, and Lincoln Laboratories. This trip seemed to have reinforced their concept, which was reflected in the interim plan that was presented to the House Appropriations Committee in the hearings for the FY 1958 budget. Gone was the monolithic rectangular parallelepiped, now replaced by four wing-like structures, one housing administration and the other three providing laboratories for chemistry, physics, and engineering. The construction would be of the modern modular type with movable partitions that would allow flexibility and convertibility in space configuration.

At these hearings, the Bureau requested \$2 million "to undertake the design and specifications for most of the construction program."<sup>81</sup> Astin gave a good sales talk, stating, "I feel strongly that the fulfillment of these plans will mark a major turning point in the history of the National Bureau of Standards." He followed with a remarkable statement which articulated the aim of his administration as well as his feelings about what had happened to the Bureau during and after World War II: "I believe the laboratories now contemplated, when completed, will help to raise the National Bureau of Standards to the stature which it had in world science before World War II."<sup>82</sup>

Astin, however, had a serious problem. The rough estimate made earlier had increased alarmingly. What was once \$63.5<sup>83</sup> million had jumped to \$85.81 million. Most of the increase was in the buildings, which had jumped \$17.7 million—from \$33.627 to \$51.325 million. Interestingly, Bolton's "wild guess" of \$20 million for equipage had increased by only \$0.4 million. When increases for site development, utilities, a railroad spur, and a number of smaller increases were added, the total increase was \$21.68 million or just about one-third of the original estimate.<sup>84</sup> It turned out that the bulk of the increase was in the ratio of usable or assignable area of the buildings to the total area. The GSA had used a ratio of 70 percent which was typical for the kind of buildings (offices, courthouses) that it was familiar with. Visits to other laboratories and questionnaires sent by the architect to twenty-seven firms specializing in designing laboratories showed that for this type of facility, a ratio of 50 percent to 55 percent was more the norm because of the space needed to provide services to the laboratory areas. With an increase of 70 000 square feet of assignable area in Bureau requirements, this lower ratio added 555 000 square feet of space.<sup>85</sup>

---

<sup>81</sup> House Committee on Appropriations, Subcommittee on Department of Commerce and Related Agencies, *Department of Commerce and Related Agencies Appropriations for 1958: Hearings Before a Subcommittee of the Committee on Appropriations*, 85th Cong., 1st sess., National Bureau of Standards, 12 March 1957: 199.

<sup>82</sup> *Ibid.*

<sup>83</sup> The original \$60 million estimate (\$40 million for site acquisition and construction plus \$20 million for equipage and relocation) settled down to \$63.5 million which included funds for reinstalling equipment and site development.

<sup>84</sup> Appropriations Hearings for 1958: 208.

<sup>85</sup> *Ibid.*, 206, 208-210.



The committee was not pleased. Fred S. Poorman of the PBS was firmly admonished, and Chairman Preston did not spare Astin: "I am fearful, doctor, since you got the green light on the purchase of the land you may have modified your plans and made them more elaborate than you had in mind when you appeared before us last year." Assured that the only major increase was the 70 000 feet of space, Preston nevertheless continued, "I am not sure if we had known it was going to cost \$85 million we would have approved the \$930 000 last year. This is an amazing increase."<sup>86</sup> It is possible that without Astin's reputation for rectitude developed during the AD-X2 affair and his subsequent appearances before the Appropriations Committee, the committee might have considered the low estimate to be a subterfuge to get money appropriated and the project underway. The Congress did not appropriate the requested \$2 million, but at the same time, it did not veto the project. It merely postponed it.

Now began a fallow period in the appropriations area.<sup>87</sup> Redesign of the basic laboratory and other savings, such as cancellation of the railroad spur, reduced the estimate to \$82 million, and the Bureau asked that the FY 1959 budget include a request for design and construction funds. The president, however, did not request any such funds. Nevertheless a supplemental appropriation request for \$3 million was allowed, and the funds were appropriated. The Bureau could now begin serious design work.

During 1958, with the flight of the sputniks, two new pieces of equipment—a linear accelerator and a 1 000 000 pound dead weight machine—had become paramount. The Bureau requested that construction funds be sought in the 1960 budget, particularly for the critical Radiation Physics and Engineering Mechanics Laboratories. This request was disapproved because of the president's "no new construction starts" policy. Nevertheless, work did not completely stop. An architectural design contract was negotiated with Voorhees, et al., and detailed architectural work was begun.

Finally, five years after the relocation project was initiated, construction funds were included in the FY 1961 budget request. Ironically, the first funds were not for the general purpose laboratories, but for the Radiation Physics Laboratory and the Engineering Mechanics Laboratory, facilities which had not even been considered at the beginning of the relocation project. Along with funds for these facilities were requests for the boiler plant, initial site development, and utilities. The total request was for \$23.5 million, with \$9.27 million for the Radiation Physics Laboratory and

---

<sup>86</sup> Ibid., 202.

<sup>87</sup> The chronology given here is from: Memorandum, A. V. Astin to the Secretary of Commerce [F. H. Mueller], "Planned relocation of NBS laboratories at Gaithersburg, Maryland," Feb. 2, 1961. (NARA, RG 167, Astin File, Box 35, Folder Gaithersburg Site and Relocation 1955-1961.) The chronology is printed verbatim in House Committee on Appropriations, Subcommittee on General Government Matters, Department of Commerce, and Related Agencies, *General Government Matters, Department of Commerce, and Related Agencies Appropriations for 1962: Hearings Before a Subcommittee of the Committee on Appropriations*, 87th Cong., 1st sess., National Bureau of Standards, 3 May 1961: 879.

\$6.49 million for the Engineering Mechanics Laboratory. The remainder was for the more general work.<sup>88</sup>

Part of the FY 1961 budget request also included funds for a nuclear reactor. This request was for \$9.1 million,<sup>89</sup> but it was part of the Plant and Facilities request, not the Gaithersburg relocation. This caused no little amount of confusion. The reasoning was that while the radiation and mechanics laboratories were replacements of facilities already existing at the Van Ness site, the reactor was a completely new facility with no counterpart at the old site. Undeniably, the Bureau maneuvered to keep down the cost of the Gaithersburg move.

In the meantime, design of the new facilities proceeded apace. In June 1960, just six months after the FY 1961 hearings, the architects produced a model of the proposed facilities. On June 1 the model was presented to the associate directors and the following day to the press. Pictures appeared in the local papers on June 3.<sup>90</sup>

By now the total estimated cost of the Gaithersburg relocation was \$94 million. The new estimate included funds for the radiation and mechanics laboratories, some new funds for a cyclotron laboratory, and funds for a fallout shelter. The increase in costs due to inflation was not an inconsiderable part of the price rise. Indeed, economies had reduced the original \$85 million to \$81.58 million by 1959, but inflation had increased the estimate to \$87.14. The \$85 million estimate proved remarkably accurate. Only the addition of \$9 million for the nuclear reactor increased it.

Congressman Elford A. Cederberg was not upset by the \$94 million figure. "If you can do that you are doing reasonably well," he said. "I doubt if you can stay within that \$94 million figure when you start to consider it cost almost \$68 million for one office building here on the Hill. If you can do it I think you are doing well."<sup>91</sup>

Chastened by the success of the Soviet space effort, the Congress appropriated the full \$23.5 million requested for FY 1961. Groundbreaking for the Engineering Mechanics Building took place on June 14, 1961. Secretary of Commerce Luther Hodges wielded the same gold-plated shovel that had been used in the groundbreaking ceremony for the Chemistry Building in 1915 at the old site. The log jam was broken, and both appropriations and construction progressed steadily.

The final design was very different from the original. If one counts buildings connected by corridors as wings, then in the administration/general-purpose-laboratory complex there were nine wings. By the time the new facilities were dedicated in

---

<sup>88</sup> House Committee on Appropriations, Subcommittee on Department of Commerce and Related Agencies, *Department of Commerce and Related Agencies Appropriations for 1961: Hearings Before a Subcommittee of the Committee on Appropriations*, 86th Cong., 2d sess., National Bureau of Standards, 14 January 1960: 286.

<sup>89</sup> The final cost was \$8.85 million for the reactor and \$490 000 for an isotope separator. Letter and attachments, A. V. Astin to J. H. Hollomon, February 8, 1965. (NIST RHA; Director's Office; Box 381; Folder 1/1/65-4/30/65)

<sup>90</sup> Robert S. Walleigh, "The Gaithersburg Site," in *NBS/NIST, A Historical Perspective, A Symposium in Celebration of NIST's Ninetieth Anniversary, March 4, 1991*, Karma A. Beal, ed., Natl. Inst. Stand. Technol. (U.S.) Special Publication 825; April 1992: 52.

<sup>91</sup> Appropriations Hearings for 1961: 304.

November 1966, the main administration/laboratory complex and three special-purpose laboratories—Engineering Mechanics, Radiation Physics, and the Reactor—were completed. Five more—Industrial, Non-Magnetic, Sound, Concreting Materials, and Hazards—were under construction.<sup>92</sup>

Besides laboratories, there were a number of service buildings all completed by 1964. A power plant with an adjacent electrical substation installed by the Potomac Electric Power Company and a special gas inlet station provided the power and heat services. A supply and plant building provided facilities for purchasing and maintenance, and the Bureau's motor vehicles and equipment were maintained in a garage service building. One of the wings of the administration-laboratory complex contained the instrument shops.

The focal point of the whole site was an eleven-story high-rise office building containing all the activities, administrative and otherwise, that required only office-type space. The director's office was located at the southwest corner of the eleventh floor, and the view from there was little short of spectacular. Attached to the high-rise building were the library, the cafeteria, a meeting complex containing four small auditoria-meeting rooms, the 289-seat Green Auditorium, the large 756-seat Red Auditorium, and the instrument shops. These wings were arranged to provide a



Eleven stories high, the Administration Building towers above the other buildings in the laboratory complex. The building houses the director and his staff as well as other activities that do not require laboratory space. The Red Auditorium to the left, and the Technology Building to the right, flank the Administration Building.

<sup>92</sup> Appendix J lists the Gaithersburg site buildings with the dates of construction, occupancy, and square footage for each building.

In 1948 a sundial of unusual design and high degree of accuracy was erected on the terrace east of the Chemistry Building by members of the NBS staff in honor of Lyman J. Briggs. In January 1966, R. Newton Mayall, designer of the sundial, advised the Bureau that moving the sundial to Gaithersburg would introduce an error of 0.002 feet, "a negligible amount except for the purist. The dial should be raised at an angle of 0.003 feet in 1 foot to correct for latitude. Again a negligible amount, except for the purist." The sundial was moved to its new location in the Administration Building courtyard.



The original gates of the Bureau's main entrance to the former site—Connecticut Avenue and Upton Street—with their background of trees and azaleas, became a symbol of the Bureau. The gates were relocated to the Gaithersburg campus on the occasion of the Bureau's 75th anniversary in 1976.

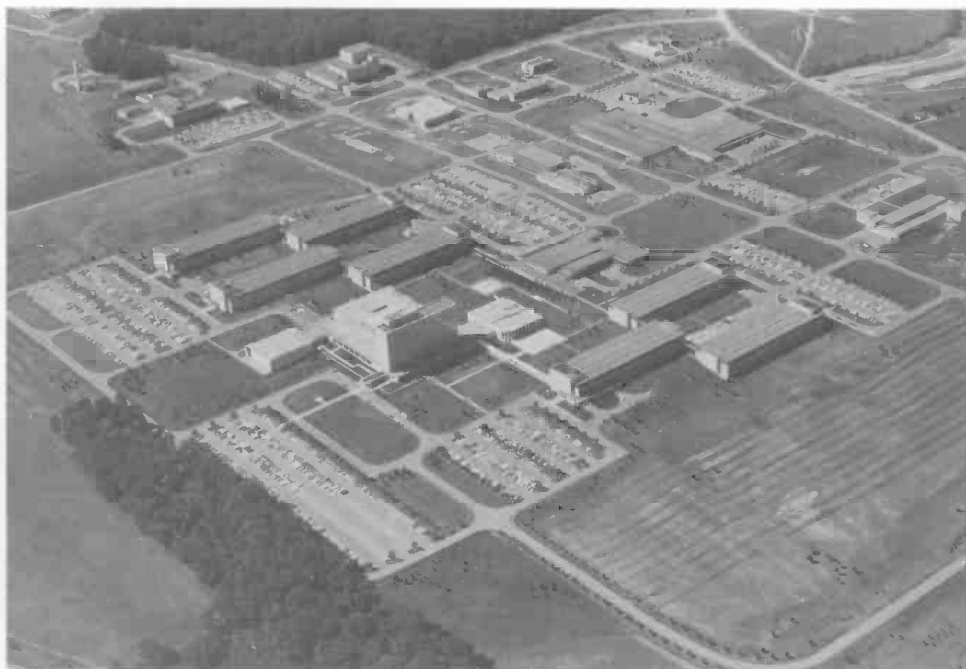

Aerial view of the Bureau's Gaithersburg campus taken August 12, 1969. The arrangement of buildings in a spacious, park-like setting had antecedents in forms such as the corporate research park, the American college campus, and the Bureau's former site in Washington, D.C.



Interior of the NBS Library showing the helical white terrazzo staircase to the mezzanine.

courtyard, delimited by the huge ground-level windows of the cafeteria on one side, and glass corridors around the remaining three sides.

The general-purpose laboratories were also wings of the Administration Building complex but further removed from it. A long, multi-level corridor on a north-south axis formed the main spine of the complex and connected the Metrology, Physics, Chemistry, and Materials Buildings with the western edge of the Administration Building. These buildings, each 96 ft. × 300 ft., alternately branched from this spine. A similar corridor on the west side of the laboratory buildings ran parallel to the main corridor and connected three more general-purpose laboratories (Polymers; Instrumentation, later renamed Technology; and Building Research) and the instrument shops with the west end of the Materials Building. The linear system made all buildings in the main complex easily accessible from all the others without creating a need to go outdoors. At the outside end of each of the attached buildings was a parking lot. All the other buildings on the site were similarly supplied with parking.

The general-purpose laboratories were the heart of the system. All rose three stories above the ground. Three (Technology, Physics, and Metrology) also had an underground level. Along the north and south sides of the buildings were windows. The rooms along these sides were basically designed to be offices, although they could be arranged for some light experimental work. Thus, each of the above-ground offices had a large window. All construction was modular, 11 ft. × 16 ft. for the basic office module and 11 ft. × 24 ft. for the laboratory module.<sup>93</sup> The office and laboratory modules could be lengthened in increments of 11 feet, and in addition, if a very large laboratory was required, the wall between the back-to-back laboratory modules could be removed to create a 48 foot wide space. A cross-section of the building showed an office module (16 feet), a corridor (8 feet), a laboratory module (24 feet), another laboratory module (24 feet), a corridor (8 feet), and another office module (16 feet). The design had the flexibility requested by the staff and the advantage that each scientist could have an office just across the corridor from his laboratory.

Because of its complexity the whole construction sequence was divided into four phases:<sup>94</sup>

Phase I: Engineering Mechanics, Power Plant, and initial site work.

Phase II: Radiation Physics, Administration, and service buildings.

Phase III: Seven general purpose laboratories,

Phase IV: Sound, Hazards, Industrial, and Concreting Materials.

A fifth phase was added for the Fluid Mechanics and Non-Magnetic Buildings, and a gate house. The schedule was followed very well and work was completed by 1970. The Reactor was not included in the phases listed above since it was not officially part of the Gaithersburg relocation.

<sup>93</sup> The 11 foot dimension was a compromise between the architects, who wanted 10 feet, and the Laboratory Planning Committee, which wanted 15 feet.

<sup>94</sup> House Committee on Appropriations, Subcommittee on Departments of State, Justice, and Commerce, The Judiciary, and Related Agencies, *Departments of State, Justice, and Commerce, The Judiciary, and Related Agencies Appropriations for 1964: Hearings Before a Subcommittee of the Committee on Appropriations*, 88th Cong., 1st sess., National Bureau of Standards, 28 February 1963: 1098.

On March 27, 1962, the first permanent employees moved to the site, forming a skeleton crew from the Plant Division. By October 1963, the steam and chilled water generation plant was continuously manned. In April 1963 work was begun on the Reactor Building and, a month later, the first scientific staff moved to Gaithersburg to supervise its construction. The building was completed in August 1965, but the reactor (NBSR) itself was finished in late 1967. This supervisory group of staff was followed in October by the Office of Weights and Measures and the Engineering Mechanics Section staff. Almost two years later, on September 13, 1965, the Administration Building was occupied,<sup>95</sup> and a month after that, the Radiation Physics Building staff and equipment completed a difficult move to their new building.

Logistically, the most difficult moves were those to the seven general purpose buildings. The complicated assignment of space to the various divisions was carried out by the Gaithersburg Planning Group. After conferences with the division chiefs, the planning group assigned space for the divisions' laboratory and office needs and relayed the requirements to the architects.<sup>96</sup> Then, on floor plans of the offices and laboratories assigned to the divisions, the location of each item of equipment and furniture was marked. The items themselves were tagged and coded to correspond to the locations on the plans. Books, files, and small pieces of equipment were placed in cartons and similarly marked. When the time arrived for a division's move, the division staff stayed home for as many days as necessary to complete the move. When staff reported to their new quarters in Gaithersburg, they found their desks, bookcases, and equipment where they had requested them to be placed. The system worked remarkably well.

---

<sup>95</sup> The American flag last flew at the Van Ness site on September 10, 1965. The same flag flew once at Gaithersburg two days later, and then was presented to Astin as a memento. Since Astin's office after that date was located at Gaithersburg, he wanted a flag to be raised at the site, but there was no flagpole. The GSA had not planned on constructing one until the completion of the site. Using the GSA plans, the Bureau let its own contract for the flagpole. The \$44 768 contract called for a 90-foot stainless steel flagpole, the removal of a small building, the leveling and sodding of the site in front of the administration building, the provision of a granite walkway, and a circular granite base for the pole incised with George Washington's words, "Let us raise a standard to which the wise and honest can repair." Alas, at the next House Appropriations Committee hearing on April 19, 1967, Astin, not having been thoroughly briefed, did not know the details of the contract, and was under the impression that it included only a 90-foot pole. Thus, when Congressman Andrews of West Virginia declared that the cost of the flagpole was \$500 a foot, Astin had no comeback and was embarrassed. Although the cost of the pole itself was \$100 per foot, the \$500-a-foot number stuck and Astin was constantly reminded of this by the acidulous committee chairman John Rooney. Added to the original woeful Gaithersburg cost underestimate, the incident was only partly humorous. (*NBS/NIST, A Historical Perspective*: 53)

<sup>96</sup> There was a definite hierarchy in space allocation. Institute directors and division chiefs were provided a double office module adjacent to a double module for secretarial and administrative staff, and beyond this a single module for an assistant division chief or lower aide, or a double module for the deputy institute director. Section chiefs had a single module adjacent to a secretary in a single module. Access to these officials was past a secretary. Scientists of grade GS-15 or above had private offices, but lower grades shared office space. There were also distinctions in furniture. Institute directors, their deputies, and division chiefs were allowed a couch and handsome wooden desks, credenzas, bookcases, and comfortable upholstered chairs. Section chiefs were permitted older wooden desks and other furniture, but grey steel was more the norm. But while these furnishing rules were stipulated, they were not followed slavishly. Window plants became common and often elaborate.

The move into the general-purpose laboratories began in March 1966 and was finished by the end of the summer. During the same period the library was moved, completing the bulk of the relocation. Still left to finish, however, were the Sound, Hazards, Industrial, Concreting Materials, Non-Magnetic, and Fluid Mechanics Buildings. All were completed in 1968 except the Fluid Mechanics Building which was finished in 1969.

Plans for the dedication of the Gaithersburg installation began in 1964.<sup>97</sup> By 1965, it was proposed that President Johnson be asked to dedicate the new facilities, and the Visiting Committee was asked to plan a special symposium. A letter inviting the president for the date of June 14, 1965, was prepared for the secretary's signature, but this plan fell through.<sup>98</sup> In a second attempt, the president was invited and the date planned for November 15, 1966. According to the agenda, Secretary John T. Connor would preside, and the formal ceremonies would be followed by a special luncheon. The next two days would feature a symposium on "Technology and World Trade," followed by a day of open house for the general public.<sup>99</sup> The dedication was held on the stipulated date in the courtyard facing the library. Speaking to some 3000 distinguished guests, Connor called the facilities "a blue-chip investment . . . which will pay dividends to American science, industry, and commerce." The president was unable to attend, but he did send a message, stating, "This eminent institution now has the resources for even greater service to America and the world."<sup>100</sup> The two-day symposium, attended by over 500 international dignitaries and leaders in industry, education, and commerce, went on as scheduled. On the fourth day of the festivities, 20 000 guests toured the facilities and visited the newly opened laboratories. The Bureau had formally dedicated a new home.

The total cost of the Gaithersburg relocation is somewhat difficult to estimate, for it is hard to know when to stop counting. The costs were reviewed at the FY 1967 House Appropriations Hearings. At the time of the dedication, funds had been appropriated for all four phases, but the fluid mechanics facility was excluded because the construction bids were higher than expected. The appropriated funds totaled \$105.94 million. The Bureau asked for a final \$1.2 million to cover moving and occupancy expenses, bringing the Gaithersburg relocation cost to \$107.14 million. However, when \$8.85 million for the reactor and \$490 000<sup>101</sup> for the isotope separator were added, the total became \$116.48 million. It was almost twice the \$63.5 million estimated at the first hearing, but the Bureau now had a fine and completely adequate new home.

<sup>97</sup> Memorandum, A. V. Astin to J. H. Hollomon, "Dedication Ceremony, Gaithersburg," July 14, 1964. (NIST RHA; Director's Office; Box 381; Folder 5/64-8/64)

<sup>98</sup> Memorandum, Assistant Secretary Hollomon to the Secretary, "Dedication of New Facilities for the National Bureau of Standards," prepared January 25, 1965; Letter, Secretary of Commerce to the President, prepared January 25, 1965. (NIST RHA; Director's Office; Box 381; Folder 1/1/65-4/30/65)

<sup>99</sup> Memorandum, I. C. Schoonover to J. H. Hollomon, "Dedication of NBS Gaithersburg," July 13, 1966; Letter, John T. Connor to the President, July 18, 1966. (NIST RHA; Director's Office; Box 381; Folder Chrono File, 1/1/65-4/30/65)

<sup>100</sup> "NBS Gaithersburg Dedicated Nov. 15; Symposium, Open House Held," *NBS Standard* 11(9) (December 1966): 1.

<sup>101</sup> Appropriations Hearings for 1967: 712-716.



It is the rare visitor who, being driven around the Gaithersburg site, does not remark on its beauty.<sup>102</sup> Indeed, with its 400 acres of well-mowed lawns; 67 acres of woods in two lots; two 4 acre ponds occupied by mallards, black ducks, and large flocks of Canada geese; and the hundreds of strategically placed and well-maintained trees and shrubs, the site has more the aspect of a park than a workplace. The numbers of trees and shrubs planted are impressive: approximately 1800 large deciduous trees of 38 varieties, 926 small and flowering trees of 32 varieties, 1548 coniferous trees of 9 varieties, and hundreds of shrubs. The azaleas and rhododendrons of the pre-1990s have been replaced with deer-resistant varieties of shrubs, plants, and ground covers. Included in the collection and planted as a grove between the two ponds, in 37 varieties, are the 53 officially designated trees of the states, the District of Columbia, Puerto Rico, and the Virgin Islands. Elsewhere on the grounds are individual specimen trees, such as a spectacular weeping beech which, along with other trees and shrubs, and flowers is planted in the courtyard near the cafeteria. Not counted in the collection, but planted in the large courtyard next to the library, is the Newton apple tree. This tree is reputed to be a direct descendant (via the British East Malling Research Station and the U.S. Beltsville Agricultural Research Station) of the tree that revolutionized physics by dropping one of its apples alongside the young Sir Isaac. Beneath it is a plaque bearing the inscription, SCIENCE HAS ITS TRADITIONS AS WELL AS ITS FRONTIERS.<sup>103</sup> Artfully planted to soften the otherwise austere facade of the buildings, the trees and shrubbery provide pleasing color from spring through fall.

Upon entering the Administration Building, the feeling of spacious aesthetic design is not lost. The large reception area is floored in black terrazzo, and its walls are white or black marble. When entering, one sees on the far wall an inscription taken from a May 14, 1900, House Committee report on the bill to establish the Bureau. In gold letters, incised into black marble, the quotation states:

IT IS THEREFORE THE UNANIMOUS OPINION OF YOUR COMMITTEE THAT NO MORE ESSENTIAL AID COULD BE GIVEN TO MANUFACTURING, COMMERCE, THE MAKERS OF SCIENTIFIC APPARATUS, THE SCIENTIFIC WORK OF THE GOVERNMENT, OF SCHOOLS, COLLEGES AND UNIVERSITIES, THAN BY THE ESTABLISHMENT OF THE INSTITUTION PROPOSED BY THIS BILL.

It forms an impressive greeting.

Upholstered furniture is scattered throughout the reception area, and ample corridors lead to the auditoria, cafeteria, and library. With an immense glass wall on its north side, the cafeteria is bright and spacious, a great improvement over the one at the Van Ness site. Much use is made of wood paneling in the auditoria and on the rest of the ground floor of the Administration Building complex. Glass walls are abundant and provide a sense of spaciousness. The north wall of the library's main reading room is all glass, but the most striking architectural feature of the library is a helical white

<sup>102</sup> All the numbers given in this paragraph were provided by the Plant Division in 1992.

<sup>103</sup> One of its siblings, still fronted by a similar plaque, is the only remnant of the Bureau at the Van Ness site.

terrazzo staircase leading up to a mezzanine of stacks which look down on the reading room beneath them. Again, a sense of spaciousness is achieved. An employees' lounge was placed across the hall from the cafeteria and the Green Auditorium, and a slightly longer walk from the larger Red Auditorium. The lounge is used as a gathering place during official functions, such as meetings and symposia, and paintings of all the former directors hang in it. A corridor leads from the lounge to wood-panelled private dining rooms and to the senior lunch club. No longer serving a fixed menu boarding house style, the Gaithersburg club operates buffet style with an ample variety of food.



Left: A workman welds the framework of the apparatus that will carry the test exposure wall from the old site to Gaithersburg.

Below: The wall, built in 1948 to study the action of various weathering agents on structural materials, was moved intact on May 18, 1977. The wall contains 2059 samples of stone in the front face, and 293 in the back and ends; of these, 2032 are domestic stones supplied by 47 states, and 320 are foreign samples supplied by 16 countries. The wall is approximately 37 ft. 9 in. long, 12 ft. 10 in. high, 2 ft. thick at the bottom and 1 ft. at the top, and weighs 39.6 tons.



## ENVIRONMENTAL SCIENCE SERVICES ADMINISTRATION

In September 1963, meteorologist Robert M. White came to the Department of Commerce as chief of the Weather Bureau from his position as president of the Research Center of the Travelers Insurance Company. Along with his duties as Weather Bureau chief, he became deeply concerned with "the problem of how we have organized our geophysical or environmental scientific, engineering, and service activities in this country, particularly in the Federal Government. Have we organized ourselves so that we can attack the problems of man's natural environment effectively? And will our present organizational forms prove adequate to the tasks of the years that lie ahead?"<sup>104</sup> With the assistance of meteorologist Edward S. Epstein, then a consultant to the assistant secretary of commerce for science and technology, White prepared a report for the assistant secretary, giving his views on the organizational problems in environmental science and the role of the Department of Commerce in that field. He presented arguments that since "there is an essential unity linking the environmental sciences. . . [m]any benefits will accrue to the Federal Government and to the Nation at large by establishing a single organizational entity to conduct research and provide services dealing with man's total environment." Moreover, Commerce, with its Weather Bureau, its Coast and Geodetic Survey, and its CRPL at the Bureau, uniquely among Government agencies possessed the "experienced nucleus of scientific and technological capability including the necessary service apparatus covering the full spectrum of environmental sciences." He proposed that all the relevant units of the department be pulled together into a National Environmental Services Administration.<sup>105</sup>

White sent the proposal to Astin and Admiral H. Arnold Karo, director of the Coast and Geodetic Survey, for their comments. After receiving enthusiastic assurances of support from both, White sent the proposal to Assistant Secretary Hollomon with the recommendation that the secretary appoint a distinguished committee "for their comments and recommendation."<sup>106</sup> Hollomon, however, continued the process a little differently. He formed a three-person committee of Astin, Karo, and White, with White as Chair, to "review . . . the Environmental Scientific Activities of the Department of Commerce."<sup>107</sup> In the meantime, the assistant secretary kept the White House—particularly Science Advisor Donald Hornig—apprised of what the DOC was doing. On

<sup>104</sup> Speech, Robert M. White, "The Organization of the Environmental Sciences in the Federal Government," April 23, 1964. (NIST RHA; Director's Office; Box 382; Folder ESSA 1964-1965.) White delivered this speech before a joint banquet of the American Meteorological Society and the American Geophysical Union.

<sup>105</sup> Memorandum, Chief, Weather Bureau to Assistant Secretary for Science and Technology, Department of Commerce, "Environmental Services in the Federal Government," January 24, 1964. (NIST RHA; Director's Office; Box 382; Folder ESSA 1964-1965)

<sup>106</sup> *Ibid.* The reader will recall that the Environmental Protection Agency was established in 1970.

<sup>107</sup> Memorandum, J. H. Hollomon to Director, National Bureau of Standards; Director, Coast and Geodetic Survey; Chief, Weather Bureau, "Review of the Environmental Scientific Activities of the Department of Commerce," May 18, 1964. (NIST RHA; Director's Office; Box 382; Folder ESSA 1964-1965)

January 15, 1965, the committee issued a report which had been reviewed by a distinguished advisory group. It showed no basic difference from the original White report, except for a change in the name of the proposed agency to National Environmental Science Service and small changes in its structure.<sup>108</sup>

On July 13, 1965, Reorganization Plan No. 2 of 1965 became effective, and a new agency called the Environmental Science Services Administration, or ESSA, came into being.<sup>109</sup> On October 11, all 592 CRPL staff members were transferred to the new agency but remained in Boulder.<sup>110</sup> ESSA became a joint tenant with NBS in what became the U.S. Department of Commerce Boulder Laboratories. Within ESSA, the CRPL was renamed the Institute for Telecommunication Sciences and Aeronomy. None of the staff concerned with radio standards—who had never been part of CRPL—were transferred. However, fifteen members of the Bureau's Sound Section formed a Geoacoustics Group in the new institute, and they did move to a new location. The Bureau had lost, at least administratively, one of its elite units and valued members of another. Astin's reaction to this divestiture is not recorded. It can, however, be assumed that he probably felt some relief at the loss of the foremost of his special central responsibilities for which he had had difficulty in obtaining authorization.

#### A NUMBER OF NEW RESPONSIBILITIES

New legislation gave the Bureau a number of additional responsibilities during the period. Most of these laws arose from heightened public concern for consumer product safety, but some of them responded to other considerations. A list of the laws that involved NBS is given in Appendix C. Though they were the most numerous, the safety-related laws were not the only ones that provided the Bureau with new responsibilities. There was the automatic data processing equipment legislation (the "Brooks Act"), the Metric System Study legislation, the Fair Packaging and Labeling Act, and the Standard Reference Data Act, which gave the Bureau's existing program a sound legal basis.

Mention should also be made of the 1967 Joint Resolution to Establish a National Commission on Product Safety, and the 26-page omnibus Consumer Product Safety Act of 1972. The first act mandated the formation of a temporary commission to conduct a study of product safety and write a report to the president and the Congress. The second act formed the Consumer Product Safety Commission. A far different body from the first commission, it was given complete regulatory responsibility for consumer product safety as spelled out in the act. The law reassigned responsibility for administering the Flammable Fabrics Act and the old refrigerator safety devices legislation,

<sup>108</sup> Chief, U.S. Weather Bureau; Director, National Bureau of Standards; Director, U.S. Coast and Geodetic Survey, "Report of the Committee for Review of the Environmental Science and Service Activities of the Department of Commerce," January 15, 1965. (NIST RHA; Director's Office; Box 382; Folder ESSA 1964-1965)

<sup>109</sup> Appropriations Hearings for 1967: 490.

<sup>110</sup> Handwritten notes, "ESSA File," undated. (NIST RHA; Director's Office; Box 382; Folder ESSA 1964-1965)

thereby removing the burden of these two laws from the secretary of commerce and hence from NBS. Moreover, the act stipulated that, to the extent possible, the commission should use the "resources and facilities of the National Bureau of Standards, on a reimbursable basis." It was an important law for the Bureau.

The principal problem with these new responsibilities was finding the resources for them. With the Bureau appropriations rising at a mere 2 percent above the GNP inflation rate, expansion funds were scarce. Funds and people had to be taken from existing programs and placed on the new ones, a recourse to "reprogramming" that could only be partly successful. Astin, seeking money for NSRDS and ADP at the FY 1967 House Appropriations Hearings, complained of "enlarged responsibilities" that "have been added to the Bureau without a corresponding assignment of the resources to carry out those responsibilities. . . ." <sup>111</sup> At the 1968 hearings, he asserted, "[Belt tightening] does not provide enough. We have made available through this reprogramming process about \$1 million. We need to carry out these responsibilities that have been assigned to us in excess of \$7 million." <sup>112</sup> At the 1969 hearings, Astin protested:

Let me emphasize that in the last few years especially, we have done everything possible to reprogram or to curtail programs—and this includes people—so as to transfer the available money to the highest priority ones. But reprogramming has been made very difficult because of the new responsibilities assigned to the Bureau in the past few years by both the administration and the Congress; namely standard reference data, fair packaging and labeling, automatic data processing, flammable fabrics, and fire research. However, requested increases for these new responsibilities were not fully granted. At the same time we have tried to keep abreast of the rapid technological advances requiring basic standards and data services. This reprogramming has seriously hurt our longer established programs. We have little or no flexibility left. <sup>113</sup>

The passage during 1969 of the Metric System Study would compound the problems pointed to by Astin. The glory days were over.

### **Automobile Safety**

NBS had worked in the automotive field for many years with both Congress and groups representing various aspects of automotive development or safety coming to the Bureau for help with such problems as tire quality. Two public laws that predated the current period involved the Bureau in work on brake fluids and seat belts.

<sup>111</sup> Appropriations Hearings for 1967: 649.

<sup>112</sup> House Committee on Appropriations, Subcommittee on Departments of State, Justice, and Commerce, The Judiciary, and Related Agencies, *Departments of State, Justice, and Commerce, The Judiciary, and Related Agencies Appropriations for 1968: Hearings Before a Subcommittee of the Committee on Appropriations*, 90th Cong., 1st sess., National Bureau of Standards, 19 April 1967: 715.

<sup>113</sup> House Committee on Appropriations, Subcommittee on Departments of State, Justice, and Commerce, the Judiciary, and Related Agencies Appropriations, *Departments of State, Justice, and Commerce, the Judiciary, and Related Agencies Appropriations for 1969: Hearings Before a Subcommittee of the Committee on Appropriations*, 90th Cong., 2d sess., National Bureau of Standards, 28 March 1968: 1193.

Public Law 87-637 and Public Law 88-201 directed the secretary of commerce to prepare specifications for brake fluids and seat belts, respectively. In each case, the secretary of commerce turned to NBS for technical assistance. Working with outside groups, principally the Society of Automotive Engineers, the Bureau adopted and/or modified the existing standards. The first brake fluid standard was published on December 4, 1962, just three months after the enactment of the law, thereby complying with the 90-day deadline set by the legislation.<sup>114</sup> The standard was modified on July 31, 1963.<sup>115</sup> The properties standardized for the various types of brake fluids available were boiling point, flash point, viscosity, pH value, stability at high temperatures, corrosion, fluidity and appearance at low temperatures, evaporation, water tolerance, compatibility, resistance to oxidation, and the effect on rubber. Brake fluid was also required to pass a simulated service test.

The seat belt standard followed a similar course, but plans were made for it even before the law was passed.<sup>116</sup> Again, the plans were basically to adopt SAE standards and modify them as required. The law, enacted on December 13, 1963, required that standards be promulgated before one year had passed. On September 9, 1964, Secretary Hodges issued a "Notice of Proposed Rule Making for a Seat Belt Standard," where he announced, "Notice is hereby given that the standards for seat belts for use in motor vehicles as set forth in tentative form below are proposed to be prescribed and published as required under Public Law 88-201, approved December 13, 1963, on or before December 12, 1964."<sup>117</sup> On that date, having received comments, the secretary pointed out that the standards were essentially the same as existing SAE standards and that their purpose was "to provide the public with safe seat belts so that passenger injuries in motor vehicle accidents can be kept to a minimum" as the legislation required.<sup>118</sup>

The standards themselves consisted of a set of requirements and associated test procedures for all the components of seat belts for adults and children: the webbing (or strap), the hardware, and the assemblies. In both these cases, after the issuance of the first two versions of the standard, the secretary delegated to Astin the authority to "perform the functions vested in the Secretary of Commerce" under the appropriate law.<sup>119</sup> From then on, the notices in the *Federal Register* pertaining to the two laws were signed by Astin. While his authority was subject to policies and directives from both the secretary and the assistant secretary for science and technology, it appears that for the first time in its history, the Bureau's director was responsible for changes in mandatory standards.

---

<sup>114</sup> *Federal Register* 27 (December 4, 1962): 11941-11943.

<sup>115</sup> *Federal Register* 28 (July 31, 1963): 7773-7775.

<sup>116</sup> Memorandum, A. V. Astin to J. H. Hollomon, "Plans for Developing the Seat Belt Standard Required by Public Law 88-201," January 9, 1964. (NIST RHA; Director's Office; Box 381; Folder Chrono 1/64-4/64)

<sup>117</sup> *Federal Register* 29 (September 9, 1964): 12736.

<sup>118</sup> Public Law 88-201 quoted in *Federal Register* 29 (December 11, 1964): 16973.

<sup>119</sup> *Federal Register* 29 (February 28, 1964): 2779-2780 and *Federal Register* 30 (April 24, 1965): 5802. Quote is contained in the second of these.

Far more important for the Bureau than this delegation of authority was the question of policing the marketplace. Both laws were silent on this issue; no responsibility was given to anyone, but neither was this activity forbidden. In a memorandum to Robert E. Giles, general counsel of DOC, Astin took up the issue. He wrote, "With respect to brake fluids, it was agreed that the National Bureau of Standards would (a) test brake fluids which were sent to it on complaint, and (b) see to it that samples were collected under standard procedures on some regular basis and then tested by NBS." He then stated that the Bureau would try to get the General Services Administration or the Federal Trade Commission to do the actual collection of brake fluid samples. The procedure for seat belts would be similar. Astin then summarized:

The seat belt and brake fluids cases pose an issue of policy for the Department of Commerce. Both laws leave ambiguous the question of the agency responsible for inspection procedures. It is my view that the Department of Commerce should not attempt to put itself into the position of inspecting and policing industry, both because the Department is not equipped to perform these regulatory functions and because these functions are in conflict with the services to industry and the general relationship to industry that we now have and that we are attempting to promote. . . . Future laws such as the Automotive Tire Safety proposal should contain a section in which responsibility for inspection is made to reside with a regulatory agency such as FTC.<sup>120</sup>

With respect to these laws, the issues eventually resolved themselves. The National Traffic and Motor Vehicle Safety Act of 1966 (Public Law 89-563) specifically repealed the brake fluid and seat belt laws since the broader law made the old laws redundant. Under this law, the secretary of commerce was given the responsibility to "establish by order appropriate Federal motor vehicle safety standards. Each such . . . standard shall be practicable, shall meet the need for motor vehicle safety, and shall be stated in objective terms." Introduction into commerce of any vehicle not conforming to these standards was forbidden and punishable by fine or imprisonment. The law provided for a National Motor Vehicle Safety Advisory Council to guide the secretary.

Important for the Bureau, the secretary was directed to "conduct research, testing, development, and training" and was given the authority to make grants for this purpose. Title II of the law took up the difficult problem of tire safety, and Title III authorized the secretary to "make a complete investigation and study of the need for a facility or facilities to conduct research, development and testing in traffic safety. . . ." Finally, a 1960 act providing for a register in the Department of Commerce listing the names of persons who had their motor vehicle operator's licenses revoked was amended in Title IV to include in a National driver register each individual whose license had been denied, terminated, or temporarily withdrawn.

---

<sup>120</sup> Memorandum, A. V. Astin to R. E. Giles, "Inspection Procedures—Seat Belts and Other Safety Standards," September 24, 1964. (NIST RHA; Director's Office; Box 381; Folder 9/1/64-10/31/64)

Director Allen Astin had been prepared for the passage of Public Law 89-563. In September 1965 he had written to Assistant Secretary for Administration David R. Baldwin, "in anticipation of the passage of the Traffic Safety Act of 1966, we request approval to establish a Center for Vehicle Safety Standards, to report to the Institute for Applied Technology." A shortened version of its functions was, "conducts research, development, testing and evaluation directed at reducing the occurrence of automotive accidents and the deaths and injuries which result."<sup>121</sup>

With the actual passage of the National Traffic and Motor Vehicle Safety Act of 1966, definition of the Bureau's role became necessary. An internal memorandum of understanding between the Office of the Undersecretary for Transportation and the Bureau was drafted,<sup>122</sup> but before it could be agreed to, the Department of Transportation (DOT) was formed. All DOT activities in transportation were moved to the new department. In particular, the DOT act required the secretary of transportation to form a National Highway Safety Bureau (NHSB) to carry out the provisions of the 1966 act. The Bureau would have to consult with this new agency if it was to have a part in implementing the law.

It found its role quickly. William Haddon, Jr., M.D., who had moved from Commerce to Transportation to head the NHSB,<sup>123</sup> informed Astin that "certain tasks in the field of vehicle safety would be assigned to NBS." As a result, Astin again wrote to Baldwin asking that a new unit which he now called the Office of Auto Safety Research be formed in IAT.<sup>124</sup> This time Astin's request was granted, and the new unit was formed. Its name became the Office of Vehicle Systems Research (OVSR). In March 1967, Secretary of Commerce Alexander B. Trowbridge and Secretary of Transportation Alan S. Boyd signed an interagency agreement. The Bureau had a new organizational unit, which was completely supported by the Department of Transportation and which provided that agency continued technical support.

Organized and operated under the direction of Paul J. Brown, the office had programs in three areas: tires, occupant restraint systems, and braking systems. The main aim of the tire program was to develop a uniform quality grading system, which by law was to be in operation by 1968. This system was "one of the biggest challenges to the Safety Laboratory."<sup>125</sup> Rating tires on the basis of treadwear, traction, and temperature resistance, the system was opposed by the tire industry. The industry

---

<sup>121</sup> Memorandum, A. V. Astin to D. R. Baldwin, "Amendment to Department Order No. 90-B as Amended," July 19, 1966. (NIST RHA; Director's Office; Box 380; Folder Chrono File; July & Aug. 1966)

<sup>122</sup> Memorandum, A. V. Astin to J. H. Hollomon, "Implementation of the National Traffic & Motor Vehicle Safety Act of 1966," September 16, 1966. (NIST RHA; Director's Office; Box 380; Folder Chrono File Sept & Oct)

<sup>123</sup> Called the National Traffic Safety Agency while it was in the Department of Commerce..

<sup>124</sup> Memorandum, A. V. Astin to D. R. Baldwin, "Amendment to Department Order No. 90-B as Amended," January 17, 1967. (NIST RHA; Director's Office; Box 386; Folder Chrono 1-1-67-2-28-67)

<sup>125</sup> Paul J. Brown, "Automotive Safety Laboratory," in *NBS/NIST, A Historical Perspective: A Symposium in Celebration of NIST's Ninetieth Anniversary, March 4, 1991*, Karma Beal, ed., Natl. Inst. Stand. Technol. (U.S.) Special Publication 825; April 1992: 65-67.



fought the rule-making all the way to the Supreme Court, where the Government's position was upheld. In an about face, "one of the tire companies that strongly opposed the rulemaking is now citing the grading of its tires under the Government system in its advertising."<sup>126</sup>

The study of occupant restraint systems led to some dramatic movies. The main thrust of the work was to improve the dynamic performance of anthropomorphic dummies used in the study of humans under crash conditions. Working with a decelerator at Holloman Air Force Base, tests that simulated a 17 mph auto crash into a



Robert Christian held "Sandy Bagg," as Earl Cooke belted Sandy in place on the sled of the NBS dynamic testing machine. Sandy was one of the contenders for the "standard dummy" for dynamic testing of automobile occupant restraint systems.

<sup>126</sup> Ibid., 66.



Earl Cooke belted in an anthropomorphic dummy.

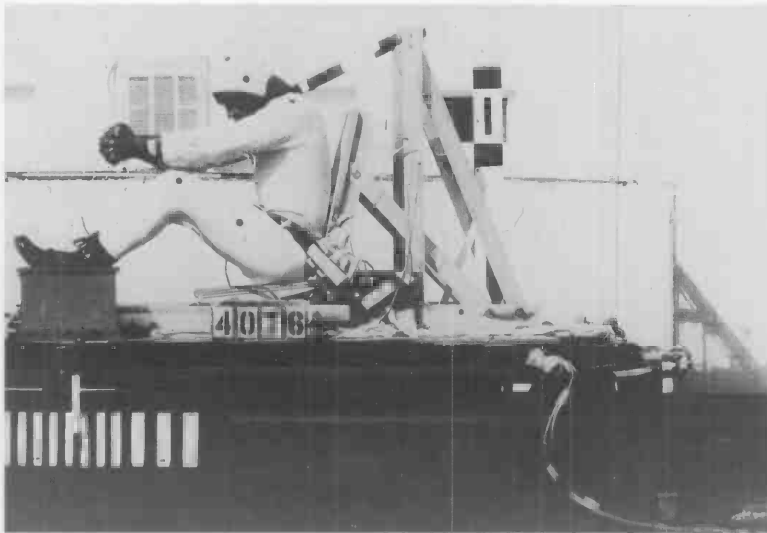

An airman volunteer underwent tests in a Daisy Decelerator, a sled-and-track device at Holloman Air Force Base, New Mexico. In 1967, NBS carried out tests on twenty-three human subjects in which physiological responses, sled velocity and deceleration, and displacement and loading of belt and shoulder harnesses were recorded.

barrier were held with human volunteers. The subjects first used lap belts alone, and then, in later tests, shoulder harnesses were added. High-speed motion pictures of these tests were compared with similar tests that had used dummies. The goal was to improve the fidelity of the latter tests. Once their fidelity had been established, these tests were cited as "justification for mandating shoulder harnesses in motor vehicles."<sup>127</sup>

Braking systems were studied with an inertia-disk dynamometer. The disks could represent anything from a small car to a 40-ton GVW vehicle. Studying such braking properties as repeated stops, fading, and brake wear, correlations were obtained with instrumented vehicles in road tests.

NBS continued its cooperative work on automotive safety throughout the 1964 to 1969 period.

### **Automatic Data Processing (ADP)**

On October 30, 1965, the 89th Congress amended the Federal Property and Administrative Services Act of 1949. More specifically, the new legislation, Public Law 89-306, added to Title I of the 1949 act a new section entitled "Automatic Data Processing Equipment."

Public Law 89-306 was introduced by Congressman Jack Brooks of Texas and has come to be famous as the "Brooks Act" in spite of its unprepossessing brevity (slightly more than two pages of text) and tone. In the addition, the administrator of general services was "directed to coordinate and provide for the economic and efficient purchase, lease, and maintenance of automatic data processing equipment by Federal agencies."

Section III (f) of the Brooks Act authorized the secretary of commerce to provide scientific and technological advice on ADP and to recommend to the President "uniform Federal ADP standards." The secretary also was authorized to undertake necessary research as required by his responsibilities under the act. These responsibilities of the secretary immediately became responsibilities of the National Bureau of Standards. The "Brooks Bill" (H. R. 4845) introduced by Congressman Brooks in February 1965 was the culmination of years of activity within the Executive Branch concerning ADP.

In the late fifties and early sixties, with the rapidly expanding use of computers by the Federal Government, management and coordination of ADP activities was a serious concern. Therefore, in September 1958, the Bureau of the Budget, the logical agency to worry about such Government-wide management questions, began a study "[t]o identify and clarify the Government-wide functions performed, or to be performed, in the utilization of Automatic Data Processing (ADP) equipment and to propose assignments of these functions to specific agencies."<sup>128</sup> The report listed fourteen separate

---

<sup>127</sup> Ibid.

<sup>128</sup> "Report of Findings and Recommendations Resulting from the Automatic Data Processing (ADP) Responsibilities Study, September 1958, June 1959," reprinted in Subcommittee of the House Committee on Government Operations, *Hearings Before A Subcommittee of the Committee on Government Operations on H.R. 4845*, 89th Cong., 1st sess., 30, 31 March and 7 April 1965: 571.

actions that the BOB, with the help of other agencies, should undertake, such as “fostering, promoting, and coordinating the interagency sharing of ADP equipment,” and “fostering and promoting desirable standardization in ADP systems which are common to all agencies.”<sup>129</sup>

All the while, ADP activities continued to grow. In 1963, it was reckoned that the Federal Government used 1,767 computers, around 10 percent of all the computers in the Nation. Thus, upon a request from Congress, in 1963 President Kennedy directed BOB to conduct a comprehensive review of the subject and prepare a report. By 1965, expenditures associated with the procurement and operation of ADP equipment amounted to \$3 billion per year, which at that time represented 3 percent of the total Federal budget.<sup>130</sup>

Completed on March 4, 1965, the Bureau of the Budget report, which was presented to President Johnson, repeated “[t]o a significant degree” the recommendations of the 1959 report.<sup>131</sup> Two of the twelve recommendations made in the BOB report specifically mentioned NBS. Recommendation 8 advised the President to “[g]ive increased attention to the coordination and evaluation of research and development programs in the field of computer sciences. Expand the resources of the National Bureau of Standards to advance the development of computer technology and systems oriented primarily toward Government needs.” Recommendation 12 (b) asked the President to “strengthen the authorities for the development, testing, and implementation of standards; the performance of research in computer sciences and the provision of advisory services by the National Bureau of Standards; and the establishment of a revolving fund to finance arrangements for the joint utilization of computer facilities.”<sup>132</sup>

The Bureau was again specifically mentioned in a section of the report on the need for expanded research on special activities. The following suggestion appeared:

The National Bureau of Standards has pioneered in the development and use of computers since 1946. It currently emphasizes research and development on common use aspects of computers and, on a reimbursable basis, it assists other Federal agencies in systems research. . . . The Department of Commerce should determine the extent to which the resources of the National Bureau of Standards need to be expanded to serve as a research center on computer science and technology, primarily oriented toward Government applications, and to serve as an advisory service and consulting center for all Government agencies.”<sup>133</sup>

---

<sup>129</sup> Ibid., 575.

<sup>130</sup> Hearings on H.R. 4845: 9. The \$3 billion figure is from the testimony of Joseph Campbell, Comptroller General of the United States. This figure includes the use of computers by Government contractors.

<sup>131</sup> *Report to the President on the Management of Automatic Data Processing in the Federal Government*, prepared by the Bureau of the Budget and submitted by John L. McClellan, Chairman, Committee on Government Operations, United States Senate, March 4, 1965. Prepared under the general chairmanship of BOB Director Kermit Gordon, the report was often called the “Gordon Report.” *Automatic Data Processing Equipment, Report of the Committee on Government Operations on H.R. 4845*: 14.

<sup>132</sup> *Report to the President on the Management of Automatic Data Processing*: 7.

<sup>133</sup> Ibid., 55.

The report also proposed legislation. Indeed, recommendation 12 (a) urged that the president “[p]ropose the enactment of legislation by the Congress which would . . . constitute an expression of congressional policy and interest with respect to effective and economical use of automatic data processing equipment.”<sup>134</sup>

The BOB study was made under the direction of Carl Clewlow, who was on leave of absence from Arthur Young and Company. Howard Gammon, Astin’s special assistant for ADP, was a member of the five-person staff. Because of the presence of Gammon on the Clewlow study staff (and of the Bureau’s Samuel N. Alexander on the BOB’s Advisory Council on ADP), the Bureau was well aware, even before publication of the report, that new responsibilities were likely to be given to it. Thus, three months before the report to the President was issued, acting upon a request from BOB, Astin wrote a short report to Hollomon: “Augmentation of Computer Related Activities in Partial Implementation of the ‘Gordon Report.’”<sup>135</sup> In it, Astin asked for an augmentation of the Bureau’s budget request for FY 1966 by \$700 000. He noted that “[i]n the course of the study on which the Gordon Report was based, there was general agreement that the increased effort by NBS should be undertaken in three areas:

1. ADP standards development.
2. Assistance to other areas.
3. Research in the computer sciences.<sup>136</sup>

Astin also noted that “[a]dditional activities to fully implement the recommendations of the Gordon Report will require additional legislative authorization.” Along with new responsibilities, legislative authorization would be forthcoming.

Delegation of the Bureau’s new activities was not slow in coming. On March 6, 1965, BOB issued Circular A-71, “Responsibilities for the Administration and Management of Automatic Data Processing Activities.” While laying responsibility on all agencies, the BOB singled out itself, the General Services Administration, the Department of Commerce, and the Civil Service Commission for special responsibilities. The DOC was directed to help achieve increased cost effectiveness in the selection, acquisition, and utilization of ADP equipment. It was given four specific functions. In shortened form, they were:

1. Provide consultant and advisory services.
2. Undertake research on computer sciences and techniques as related to Government applications.
3. Provide day-to-day guidance of an executive branch program for development and testing of voluntary commercial standards for ADP.
4. Improve compatibility in Federal Government ADP equipment.

---

<sup>134</sup> *Ibid.*, 7.

<sup>135</sup> Memorandum, Director National Bureau of Standards to J. H. Hollomon, “Proposed Augmentation of NBS 1966 RTS Budget Submission,” December 11, 1964. (NIST RHA; Director’s Office; Box 381; Folder 11/1/64-12/31/64)

<sup>136</sup> This broad scope of research is not reflected in either A-71 or the Brooks Act. Both of those limit the research to Government-related applications.

Given the contributions already made by NBS to ADP standards, it was natural for the secretary of commerce to turn to the Bureau to perform the new functions delineated in BoB Circular A-71. The implementation of these new responsibilities by NBS, however, would require more resources as well as organizational change. Thus, just over a month after the issuance of Circular A-71, Astin proposed the formation of a new organizational unit that he called the Computer Science and Technology Center. Incorporating the Information Technology Division and "those portions of the Applied Mathematics Division which are primarily in support of the functions assigned by A-71," the center would initially comprise three divisions and would report to the director. Left open was the possibility of moving the remainder of Applied Mathematics into the center and "perhaps redesignat[ing] the Center as the Institute for Mathematical and Computer Sciences."<sup>137</sup>

The proposal was adopted but not exactly in its original form. The new unit was called the Center for Computer Sciences and Technology (CCST) and was placed in the Institute for Applied Technology. It consisted of the Information Technology Division and the Computation Laboratory of the Applied Mathematics Division, which was carrying out the Bureau's responsibilities under BOB Bulletin 64-9.<sup>138</sup> The plan was carried through expeditiously. Personnel from the Applied Mathematics Division transferred on September 15, 1965.<sup>139</sup> Norman J. Ream, a computer standards expert from industry, was hired to direct the new unit.

CCST remained in IAT until 1969 when it became a separate unit, reporting to the director. As a "Center" it joined the Center for Radiation Research which, in 1968, had combined the Reactor Radiations Division and the Radiation Physics Division into the Reactor Radiation Division. Beginning in 1969, both centers reported to the director. From 1901 to 1964, the Bureau had operated with an unchanging organizational structure based on divisions and sections. In the 1964 reorganization, the structure was changed by imposing an institute level. Now, just five years later, a new type of unit somewhere between an institute and a division was formed. The changing face of science, which provided new obligations for the Bureau, required a rapidly changing organizational structure that was previously unknown at NBS.

---

<sup>137</sup> Memorandum, Dr. A. V. Astin to J. H. Hollomon, "ADP Report to the President," April 15, 1965. (NIST RHA; Director's Office; Box 381; Folder 1/1/65-4/30/65)

<sup>138</sup> Memorandum, A. V. Astin to D. R. Baldwin, "Plan to Create a Center for Computer Sciences and Technology in the Institute for Applied Technology: Proposed Revision of D.O. 90 (January 15, 1965)," August 20, 1965. (NIST RHA; Director's Office; Box 381; Folder 8/1/65-10/30/65); Executive Office of the President, Bureau of the Budget, *Bulletin* No. 64-9, January 2, 1964.

<sup>139</sup> Memorandum, A. V. Astin to G. R. Porter, "Transfer of Employees in the Computation Laboratory From the Applied Mathematics Division to the Information Technology Division," September 14, 1965. (NIST RHA; Director's Office; Box 381; Folder 8/1/65-10/30/65)

As noted at the outset of this section, the legislation recommended in the BOB report to the president was actualized in the form of a bill, H.R. 4845, introduced by Congressman Jack Brooks of Texas, a member of the House Committee on Government Operations. Cast as an amendment to the Federal Property and Administrative Services Act of 1949, it specified a new section entitled "Automatic Data Processing Equipment" for Title I of that act. Public Law 89-306, the "Brooks Act," primarily concerned itself with GSA and DOC. To the former it gave the authority and direction to "coordinate and provide for the economic and efficient purchase, lease, and maintenance of automatic data equipment by Federal agencies" and went on to spell this out in some detail. The authorization for the secretary of commerce was short:

The Secretary of Commerce is authorized (1) to provide agencies, and the Administrator of General Services in the exercise of the authority delegated in this section, with scientific and technological advisory services relating to automatic data processing and related systems, and (2) to make appropriate recommendations to the President relating to the establishment of uniform Federal automatic data processing standards. The Secretary of Commerce is authorized to undertake the necessary research in the sciences and technologies of automatic data processing computer and related systems, as may be required under provisions of this subsection.<sup>140</sup>

The law was basically an authorization to carry out the requirements of Circular A-71.

To implement these new activities at NBS required either new appropriations or reprogramming. In fiscal years 1965 and 1966, about \$2 million of reprogramming was carried out; that was felt to be the limit.<sup>141</sup> For FY 1966, the Bureau asked for \$548 000 for ADP standards, bringing the total base for ADP in FY 1966 to \$1.33 million. This was the starting point for implementation of A-71 and the Brooks Act.

At the House Appropriations Committee Hearings for FY 1967, the Bureau presented a five-year estimate of funding requirements for these new legislated responsibilities. According to the Bureau's estimate, appropriations would have to reach \$5.49 million in 1970 and \$7 million in FY 1971.<sup>142</sup> For 1970, the actual appropriation was \$1.85 million, an increase of 39 percent over the 1966 base but hardly what the Bureau felt was necessary for a first-class program. Nevertheless, NBS once again had provided expert assistance to a Federal need.

### **Fire Research and Safety**

When a special NAS-NRC panel recommended that a fire group be formed in the Federal Government, the Federal Council for Science and Technology (FCST) designated the Bureau as "a central agency for fire research" and DOC made plans to form a National Center of Fire Technology, reporting to Hollomon. This recommendation

---

<sup>140</sup> *An Act To provide for the economic and efficient purchase, lease, maintenance, operation, and utilization of automatic data processing equipment, by Federal departments and agencies, U.S. Statutes at Large, 79 (1965): 1127-1128.*

<sup>141</sup> Appropriations Hearings for 1967: 663.

<sup>142</sup> *Ibid.*, 681.

and designation was not surprising since NBS had conducted research on fire problems for many years. At the House Appropriations Committee Hearings for FY 1964, the Bureau asked for \$1.2 million to begin a new fire research program. The objectives of the proposed program were to educate the public on fire dangers, assist academic institutions in providing better education to engineers in fire prevention, support research institutions, and provide better support for the existing NBS program.<sup>143</sup>

Although supported by the International Association of Fire Chiefs, the proposed new program was strongly opposed by industry, particularly the insurance industry, as well as by the National Fire Protection Association, the leading private organization dedicated to fire protection. It was charged by these groups that the program was unnecessary.<sup>144</sup> As a result of this opposition, Congress appropriated no funds. Indeed, the next year, when the Bureau asked for only a small increase in its \$215 000 existing program, Chairman Rooney had to be reassured several times that nothing in the whole budget request had anything to do with the previous year's fire proposal.<sup>145</sup>

But this reversal did not stop Astin's attempts to respond to the increasing need for fire research.<sup>146</sup> Astin began by convening a meeting of representatives of all Federal agencies concerned with fire research problems to "explore ways of encouraging greater support for fire research work." He had in mind the formation of an Interdepartmental Committee on Fire Research. Such a committee would establish a coordinated policy on fire research and see that the policy was implemented in each participating department or agency. The FCST requested that the secretary of commerce establish such an entity. The secretary complied, and an interagency committee was established on August 5, 1966.<sup>147</sup> The committee heightened awareness in the Federal Government concerning fire research and safety problems but does not appear to have done much beyond this.

More significant progress in obtaining a full-scale fire program came from the legislative side. In early 1966, James V. Ryan, assistant chief of the Bureau's Fire Research Section, was detailed to Hollomon's office as part of the department's Commerce Science Fellowship Program. His assignment was to develop the rationale for a fire safety program and its content. Citing the enormity of the fire safety problem, which in 1965 cost the Nation 12 100 fatalities and at least \$1.6 billion in material losses, Ryan found six problem areas: insufficient and inadequate data on the

---

<sup>143</sup> Appropriations Hearings for 1964: 978-980.

<sup>144</sup> *Ibid.*, 955, 957-959.

<sup>145</sup> On reading the record, one can conclude that the fact that Hollomon's name was associated with the request was partly responsible for Rooney's opposition.

<sup>146</sup> Letter, A. V. Astin to W. A. Schmidt, Feb. 17, 1965. (NIST RHA; Director's Office; Box 381; Folder 1/1/65-4/30/65); Memorandum, J. H. Hollomon to Donald Hornig, "Interdepartmental Committee for Fire Research," Aug. 31, 1965. (NIST RHA; Director's Office; Box 381; Folder 8/1/65-10/30/65)

<sup>147</sup> Memorandum, A. V. Astin to J. H. Hollomon, "Establishment of Interdepartmental Committee on Fire Research," Aug. 5, 1966. (NIST RHA; Director's Office; Box 380; Folder Chrono File July & Aug. 1966)



nature and magnitude of the problem, lack of knowledge of basic mechanisms of flammability and fire countermeasures, lack of knowledge and awareness of fire safety in the general public, insufficient training of fire fighting personnel, lack of national standards on fire safety in building construction, and problems of coordination and mutual assistance for coterminous fire departments. To correct these problems, a six-point program was developed, consisting of:

1. Collection, analysis, and dissemination by a national organization of fire data on a uniform, national basis.
2. Research to improve understanding of fire prevention and control.
3. Improved and expanded education of fire professionals.
4. Development and encouragement of nationwide use of nationwide, uniform fire safety standards.
5. Establishment of minimum mandatory standards for performance and compatibility of fire fighting equipment.
6. Expansion of research in such areas as treatment of burn injuries, and economic recovery from fires for business and commercial areas.

This report was used by the Department of Commerce to prepare a suggested law, the Fire Research and Safety Act of 1967.<sup>148</sup>

On February 16, 1967, in his consumer message, President Johnson asked the Congress to pass ten bills into law. Among these were three that had important consequences for the Bureau. One concerned the formation of a National Commission on Product Safety, another provided amendments to the Flammable Fabrics Act, and the third was the Fire Research and Safety Bill of 1967. About the latter, Johnson said that it should be one early step in a major national effort to reduce the shameful loss of life and property resulting from fires.

Things happened rapidly. The bills were introduced in both the Senate and House. The National Commission on Product Safety was created by a joint resolution on November 20, 1967 (Public Law 90-146), and the Flammable Fabrics amendments were passed on December 14, 1967 (Public Law 90-189). The fire legislation, however, took a little longer. It was finally enacted on March 1, 1968, as the Fire Research and Safety Act of 1968 (Public Law 90-259). Except for the fact that it authorized \$5 million, rather than \$10 million, for a two-year program, Title I of the act as passed was identical to the 1967 bill. It was in the form of an amendment of the Bureau's enabling legislation, and it called upon the secretary of commerce to "provide a national fire research and safety program including the gathering of comprehensive fire data; a comprehensive fire research program; fire safety education and training programs; and demonstrations of new approaches and improvements in fire prevention

---

<sup>148</sup> Memorandum, J. H. Hollomon to J. A. Califano, Jr., November 17, 1966. In the memo Hollomon specifically cites non-uniform adoption of building construction standards and the compatibility of fire fighting equipment, as serious problems. The Ryan report was sent along with the memorandum. (J. V. Ryan, private communication.)

and control, and reduction of death, personal injury, and property damage." According to the act, it was "the sense of Congress that the secretary should establish a fire research and safety center for administering this title and carrying out its purposes, including appropriate fire safety liaison and coordination."<sup>149</sup> The Bureau had been given new authorities, and it had also been told how to change its organization to manage them. It had obtained a legal basis for one if its special central responsibilities. Title II of the act established a twenty-member National Commission on Fire Prevention and Control to study the fire problem and report in two years with recommendations on how the Nation could reduce the destruction of life and property caused by fire.

Implementation of the legislation proceeded on both the appropriation and organizational fronts. Signed into law too late to be included in the FY 1969 House appropriation request, it was appended to the later Senate request. The Senate recommended \$500 000 for Title I and \$160 000 for Title II, but in the Senate-House conference, the funds were dropped.<sup>150</sup> However, by means of reprogramming, funds were obtained to set up an Office of Fire Research and Safety in IAT under John A. Rockett. It was purely a program planning office; the technical work on fire research continued in the Fire Research Section of the Building Research Division. Only in 1972 was fire work at the Bureau given division status under Joseph E. Clark. While not yet a center, the Fire Technology Division had achieved independence and had at last obtained legal underpinning.

#### SYSTEMS ANALYSIS AND THE TECHNICAL ANALYSIS DIVISION

With the development of computers and the mathematical modeling of physical and social systems in the fifties and early sixties, the disciplines of operations research and systems analysis flourished. The Bureau's Applied Mathematics Division had a sizable program in operations research.<sup>151</sup> Upon the reorganization into institutes, the Bureau's activities in this area expanded. In FY 1965, the Bureau received a new responsibility to conduct a cost-benefit analysis service for the DOC bureaus and for other Federal agencies, and in 1967 it undertook responsibility "for developing data on decision making on . . . systems problems involving a combination of technology, economics, logistics and sociology."<sup>152</sup>

By the time the first of these announcements was published, action in this sphere had already occurred at DOC. In March 1964, all the bureaus of the department "concurred in the Inter-Bureau Agreement" to establish a Technical Analysis Group which would analyze the effect of science and technology on the programs of the

---

<sup>149</sup> *Fire Research and Safety Act of 1968, U.S. Statutes at Large*, 82 (1968): 34-39.

<sup>150</sup> John A. Rockett, private communication.

<sup>151</sup> "Data Processing and Operations Analysis on a Scientific Computer," *Technical News Bulletin* 44 (January 1960): 14-18.

<sup>152</sup> Annual Report for 1967: 5.

science-oriented agencies in the Department. This group would “conduct technical-economic analyses and develop analytic processes” which could facilitate policy making. The group, however, would not engage in policy decisions. The responsibility for establishing the group was given to the Bureau. Funds would be provided jointly by the Patent Office, the Weather Bureau, the Coast and Geodetic Survey, and NBS, all of which reported to Hollomon. The group was to be located in the Institute for Applied Technology, and was meant to be concerned solely with DOC programs.<sup>153</sup>

It did not take long for the Bureau to implement this new activity. A Technical Analysis Division (TAD) was created in IAT. Astin wrote, “It has long been clear that such an activity—an internal ‘IDA’ [Institute for Defense Analysis] for the Department—would be of very great value.”<sup>154</sup> W. Edward Cushen, trained in logic and metaphysics and experienced in operations research, was hired to head the new organization.

The first project the TAD worked on followed very naturally from the role envisioned for it. It was a study of transportation in the Northeast Corridor, i.e., the region stretching from Washington, D.C., to Boston, Massachusetts. Entered into cooperatively with DOC’s Office of Transportation, the project aimed at providing a computer simulation of transportation in the corridor to permit a systems analysis evaluation of the effect of the introduction of new technologies, such as high-speed rail, automated highways, and vertical take-off aircraft. The aim of the model was to “determine the flow characteristics of the transportation system.” The division also developed a computer model for cost-benefit analysis to aid in “decisions concerning [the] relative benefit and cost of transportation technologies for the corridor.”<sup>155</sup> This, its most famous project, was to continue for almost a decade, with support shifting from the DOC to the Department of Transportation when the latter agency was formed in 1967.<sup>156</sup>

Other early projects were also undertaken with support from DOC agencies: modeling of patent activities to predict backlogs, examiner workload, and monthly output in 1965, a study of earthquake protection with the Coast and Geodetic Survey in 1966, and the study of the World-Wide Seismology Net operated by the Environmental Science Services Administration in the same year.<sup>157</sup> Later, the work of the division expanded beyond the confines of the DOC to encompass system analysis for other

---

<sup>153</sup> Memorandum, J. H. Hollomon to A. V. Astin, “Technical-Economic Analysis,” July 30, 1964. (NIST RHA; Director’s Office; Box 381; Folder 9/1/64–10/31/64)

<sup>154</sup> Memorandum, A. V. Astin to W. F. Rapp, “The Technical Analysis Division in the Institute for Applied Technology in the National Bureau of Standards,” Oct. 28, 1964. (NIST RHA; Director’s Office; Box 381; Folder 9/1/64–10/31/64)

<sup>155</sup> Annual Report for 1965: 103.

<sup>156</sup> “Computer Model Simulates Northeast Corridor,” *Technical News Bulletin* 53 (January 1969): 8-9, 20. “Transportation in the Northeast Corridor,” *Technical News Bulletin* 56 (August 1972): 186-187.

<sup>157</sup> Annual Report for 1966: 94-95.

Federal agencies and even local governments. In 1967, TAD noted that it was the largest systems analysis group “[w]ithin the civilian agencies of the Government” and that it assisted “other agencies in the solution of their specific systems analysis problems.” It also conducted “research on cost benefit analyses for Government programs.”<sup>158</sup> This represented a significant expansion of its original mandate, and work for other agencies flourished. Projects were undertaken for the Agency for International Development, the Department of the Interior, the Post Office Department, the Department of Housing and Urban Development, the Atomic Energy Commission, the Coast Guard, and even Montgomery County, Maryland—working with that locality “to determine an optimal school districting plan.”<sup>159</sup> In 1970, the NAS-NAC-NRC evaluation panel, a very strong supporter of the TAD, wrote:

TAD has helped: the Interstate Commerce Commission evaluate its plan for an adequate national freight-car supply; the Maritime Administration determine a preferred deployment of inland cargo consolidation centers; the Post Office with its mail-handling and processing systems; the Weather Bureau by evaluating the performance of its Miami hurricane warning center; the Atomic Energy Commission with its problem of controlling the supplies of nuclear material.<sup>160</sup>

Soon the work for other agencies overshadowed the work for DOC agencies, and the division grew to a size of almost 150 persons. Many of these, however, were not in the full-time permanent category.

But Bureau support for the division lagged. Astin was strapped for funds to carry out mandated responsibilities and did not support the division, despite his praise for it. After praising the work of the division at the Bureau oversight hearings in 1971, the now director emeritus noted, “But this activity receives only 10 percent of its funding through direct appropriation, far too small a percentage to provide for the planning and techniques development that are necessary to achieve the potential benefits.”<sup>161</sup>

The lack of RTS support became a bone of contention with the Evaluation Panel. In its 1970 review, the panel noted “despite continuing emphasis on this matter by the Panel, the Bureau’s support to TAD in the form of RTS funds remains far below the desirable level.” It recommended that RTS funds be increased to at least one third of the total budget.<sup>162</sup> Then, in the following year, the panel almost rebelled. When

---

<sup>158</sup> Annual Report for 1967: 99.

<sup>159</sup> Annual Report for 1968: 134-135; Annual Report for 1969: 156.

<sup>160</sup> National Academy of Sciences, National Academy of Engineering, National Research Council, “Annual Report of the Panels for the Evaluation of the Research, Development and Technical Service Activities of the National Bureau of Standards 1970-1971”: 368.

<sup>161</sup> Subcommittee on Science, Research, and Development of the House Committee on Science and Astronautics, *National Bureau of Standards Oversight Hearings: Hearings Before the Subcommittee on Science, Research, and Development of the Committee on Science and Astronautics*, 92d. Cong., 1st sess., 22 September 1971: 222.

<sup>162</sup> NAS, NAE, NRC, “Annual Report of the Panels for the Evaluation”: 372.

the Bureau did not increase RTS support for TAD, the panel noted that “this absence of response to the most mature and significant communication the Panel had ever addressed to the Bureau left the Panel in something of a quandary.”<sup>163</sup> One of its members proposed that the Bureau take one of three specified courses of action:

1. Reduce the scope of TAD to service NBS alone.
2. Arrive at a clear understanding that the TAD exists for the benefit of all Government agencies, and that the Bureau simply become its manager.
3. Remove it from NBS and attach it to another agency, or make it into a private corporation or institute.

The source of the problems experienced by TAD in the Bureau is not hard to understand. The TAD had only a tenuous relation at best to the Bureau’s measurement standards mission. As long as it was small and as long as it was providing a service to NBS and other DOC agencies, this could be tolerated. However when it became primarily a contractor for other Government agencies, then TAD was open to the criticism that its work could be done as well or better by the private sector. In fact, these were exactly the conclusions that DOC came to. In August 1974, DOC abolished the program, citing the fact that TAD’s work appeared to compete with services offered by the private sector, that 60 percent of its work did not relate to the NBS mission, and that all the DOC agencies operate under tight personnel ceilings. Bureau management went to great pains to relocate TAD personnel either in or outside of the Bureau. By March 1975, most of them had been relocated.<sup>164</sup> The official abolishment date was July 22, 1975.<sup>165</sup> It was an unfortunate situation that such a competent organization had been located in the wrong place.

#### THE NATIONAL MEASUREMENT SYSTEM

The use of systems analysis at the Bureau was not limited to the sophisticated computations of TAD and the Applied Mathematics Division. Ever concerned with the role of the Bureau in the society at large and doubtless spurred by his appointment as director of the Institute for Basic Standards, Robert D. Huntoon applied the concepts of system analysis to what he called the “national measurement system.” In his analysis, Huntoon saw all the Nation’s measurement activities as forming a social system similar to the communications, transportation, defense, education, medical, and legal systems.<sup>166</sup> The analysis was undertaken “partly because of a growing realization of the

---

<sup>163</sup> National Academy of Sciences, National Academy of Engineering, National Research Council, “National Bureau of Standards—An Evaluation—1971–1972”: 118.

<sup>164</sup> Richard W. Roberts, State of the Bureau—Gaithersburg, March 11, 1975.

<sup>165</sup> U.S. Department of Commerce, National Bureau of Standards. “Organizational and Staffing Changes as Provided in DOO 30-2B,” *Administrative Bulletin*, 75-49, September 10, 1975.

<sup>166</sup> Annual Report for 1967: 7.

all-pervasive nature and great economic importance of the nation's measurement activities, and partly because of the challenge to NBS in putting its splendid new facilities to optimum use for the benefit of the nation."<sup>167</sup>

Huntoon demonstrated that measurement was big business. He estimated that each day something on the order of two billion measurements were made.<sup>168</sup> Rather more meaningful was the calculation that in 1963, five economic sectors, contributing \$396 billion to the \$591 billion gross national product, spent \$13.9 billion and 1.3 million man years in measurement. He also estimated that the Nation had investments of \$25 billion in measurement instruments and \$20 billion in data and that these were increasing at yearly rates of \$4.5 billion and \$3 billion, respectively.

Huntoon's analysis of the national measurement system began by recognizing that, as in many other social systems, it consisted of two subsystems, an "intellectual system" and an "operational system." The intellectual system consisted "of the set of rules and conventions that govern the operation of the system. . . . [It] is universally applicable, much like the laws of physics. . . . An example of an intellectual system is the International System of Units (abbreviated SI for *Système International*)—an intellectual concept, a set of rules regarding units. This system in [sic] universal; not only is it international, but it could be used on other planets if we ever succeed in communicating with them."<sup>169</sup>

The operational subsystem, on the other hand, consisted of the people and organizations which were actually involved in measurements and insured "proper linkage of the U.S. system to the international measurement system." The operational system also had to "analyze and work on the pool of unmet needs" and "maintain and disseminate information on the reservoir of capability" that a user might call upon. This second subsystem consisted of three networks: an instrument network, a data network, and a techniques network. The instrument network provided "calibrated traceable instrumentation, consistent and compatible with the national standards." Since the national standards were part of the intellectual system, the instrument network was directly tied to that system. The data network provided critically evaluated data on the properties of materials so that more often than not, the system user did not need to make a measurement. The National Standard Reference Data System was clearly central to this network. The techniques network disseminated knowledge on how to make meaningful measurements.<sup>170</sup>

The overriding rationale for the whole system was to provide assurance that all measurements, wherever made, were compatible. Compatibility provided a firm quantitative basis for the interchange of goods and services in commerce, of machine parts and devices in industry, and of scientific and technical information. The system also

<sup>167</sup> Robert D. Huntoon, "Concept of a National Measurement System," *Science* 158 (October 6, 1967): 67.

<sup>168</sup> This estimate included such passive activities as reading a clock or a speedometer.

<sup>169</sup> Robert D. Huntoon, "The Measurement System of the United States," in *Proceedings of the 1966 Standards Laboratory Conference*, Natl. Bur. Stand. (U.S.) Miscellaneous Publication 291; July 1967: 89.

<sup>170</sup> Annual Report for 1967: 11.

provided a quantitative basis for a safe course of action. For example, an aircraft pilot made essential decisions during flight based on the readings of "measurement output dials." These readings had to be compatible with similar readings by other pilots and air controllers if the flight was to be safe and on schedule.<sup>171</sup>

Compatibility was assured by having all measurements traceable to the units for the basic quantities, as embodied at present in the SI.<sup>172</sup> Because the Bureau developed and maintained its own versions of these basic units, it had the central role in the national measurement system. NBS also provided calibration services and standard reference materials for the instrument network, operated the NSRDS which generated and evaluated data for the data network, and developed measurement methods for the techniques network.

But the Bureau did not work alone in implementing the national measurement system. Even in providing calibration services, it had—and needed—help. The Bureau was instrumental in the development of a chain of standards laboratories and the organization of the yearly meetings of the National Conference of Standards Laboratories. In turn these became a new part of the national measurement system. Moreover, laboratories in industry, government, and academia, at one time or another, inadvertently or by design, provided information to the instrument, data, and techniques networks, and there were special laboratories devoted solely to one or more of these networks. Scientific societies, via their publications, were disseminators of instrument design information, data, and techniques. Of particular importance were the standardizing societies like the American Society for Testing and Materials, American Institute of Mining, Metallurgical, and Petroleum Engineers, and the Society of Automotive Engineers, which provided forums in which test methods or special purpose measurement methods were developed. Indeed, the concept of the national measurement system was so all-encompassing that all scientific and engineering laboratories were both providers to and users of the system.

For the Bureau, the national measurement system was a very natural way of defining its role in the economic and scientific life of the Nation. Thus, the concept was widely promulgated in publications, symposia, and conferences. Internally, the national measurement system concept was most useful in analyzing the programs of the Institute for Basic Standards, since it had responsibility for the basic national standards, and the NSRDS was one of its units. In 1974, there were eighteen "microstudies" or miniature planning-programming-budgeting-type issue studies of the national measurement system in relation to each institute program area.

---

<sup>171</sup> Huntoon, "The Measurement System of the United States": 91.

<sup>172</sup> *Ibid.* Huntoon recognized four such quantities—mass, length, time, and temperature—along with their base units. He points out that the SI recognizes two other base units, the ampere and the candela.

## THE CLEARINGHOUSE FOR FEDERAL SCIENTIFIC AND TECHNICAL INFORMATION

We saw how the Bureau, largely on its own initiative but strongly supported by the Federal Council for Science and Technology (FCST), created the National Standard Reference Data System, a new program for the collection, production, critical evaluation, and dissemination of scientific data. In February 1964, as part of its reorganization into institutes, the Bureau inherited another program for the dissemination of scientific and technical information.

That the Federal Government should be involved in such an information activity had been accepted for a long time. In 1945, by Executive Orders 9568 and 9604, President Truman established an interdepartmental board called the Publication Board to collect and declassify World War II technical data—including German and Japanese data—and make it available to industry. The following year the Department of Commerce established the Office of Technical Services (OTS) to consolidate the activities of the Publication Board and other organizations. Then the 81<sup>st</sup> Congress became involved. In 1950, it enacted Public Law 776, which directed the secretary of commerce to “establish and maintain within the Department of Commerce a clearinghouse for the collection and dissemination of scientific, technical, and engineering information.” Such information was to be collected, coordinated, and otherwise analyzed “from whatever sources, foreign and domestic, that may be available.” It was to be made available in various forms to the whole Nation.<sup>173</sup> These mandated activities became the Technical Documentation Center in the OTS.

In 1964, the Bureau inherited the OTS and placed it in the Institute for Applied Technology. Then in February, following endorsement by the FCST, a clearinghouse of a somewhat different character from the one described in Public Law 776 was established. This one was called the Clearinghouse for Federal Scientific and Technical Information. It would be concerned solely with Federal information, but it would be the “national center for the dissemination of Government-generated information in the physical sciences, engineering, and related technology.” It was “established as the single point of contact in the Executive Branch for supplying the industrial and technical community with unclassified information about Government-sponsored research and development in defense, space, atomic energy, and other national programs.” The clearinghouse made accessible inexpensive research information that could “aid in the development of a new product, solve a processing problem, or increase productivity through technical improvement.”<sup>174</sup>

---

<sup>173</sup> *An Act To provide for the dissemination of technological, scientific, and engineering information, U.S. Statutes at Large*, 64 (1950): 823.

<sup>174</sup> Letter, A. V. Astin to J. L. McClellan, January 25, 1965. (NIST RHA; Director's Office; Box 381; Folder 1/1/65—4/30/65). Senator McClellan was a sponsor of Public Law 776.



Using rented space in Springfield, Virginia, the clearinghouse was in operation by July 1, 1964<sup>175</sup> and was dedicated in January 1965.<sup>176</sup> It had a broad program. During its first year, employment increased from 236 to 316, and its activities expanded. In that year the clearinghouse sold approximately 1.5 million copies of documents at the cost of reproduction and handling. It collected 60 000 documents, expanding its activities with the Atomic Energy Commission, NASA, and other agencies. The clearinghouse consummated an interagency agreement with the Department of Defense whereby it would do the processing on that department's research and development reports and distribute them to contractors as well as to the general public. It also provided more than a dozen more general services, including journals such as *Government-Wide Index to Federal Research & Development Reports*, *U.S. Government Research and Development Reports*, and *Technical Translations*. There were even activities designed to improve the efficiency of clearinghouse operations. For example, a demand-prediction model was developed whereby a report could be printed in quantity prior to any requests being received. This precluded the need for expensive individual handling.<sup>177</sup>

Astin considered the clearinghouse to be one of his special central responsibilities, along with the Central Radio Propagation Laboratory and automatic data processing. He sought to obtain increases in appropriations for it, although not as ardently as he did for the NSRDS. A large part of the clearinghouse was self-supporting through sales, but there were some services which were not. The Government-wide index, referral services, reports on research in process, and the development of focused and targeted industrial dissemination needed appropriations. Increases were not major, but they did come. In 1964, the appropriation was \$940 000.<sup>178</sup> By 1969 it had increased to \$1.28 million.<sup>179</sup>

Until 1969 the clearinghouse was administratively located in IAT where it clearly served the function of assisting industry in the application of new research findings to the development of technology. In 1969, the Bureau's information programs were collected in a new organization called the Office of Information Programs. In the new post of associate director for information programs, Edward L. Brady directed the organization. Along with the clearinghouse, the office contained the Office of Standard Reference Data, the Office of Technical Information and Publications, the Library, the Office of Public Information, and the Office of International Relations. This placement under an associate director who reported to the director attested to the importance Astin placed on information dissemination.

<sup>175</sup> Memorandum, A. V. Astin to W. F. Rapp, "Clearinghouse for Federal Scientific and Technical Information," October 28, 1964. (NIST RHA, Director's Office, Box 381, Folder 9/1/64—10/31/64)

<sup>176</sup> "Dedication of Clearinghouse for Federal Scientific & Technical Information," *Technical News Bulletin* 49 (April 1965): 60.

<sup>177</sup> Annual Report for 1965: 96-100.

<sup>178</sup> House Committee on Appropriations, Subcommittee on Departments of State, Justice, Commerce, the Judiciary, and Related Agencies Appropriations, *Departments of State, Justice, Commerce, the Judiciary, and Related Agencies Appropriations for 1966: Hearings Before a Subcommittee of the Committee on Appropriations*, 89th Cong., 1st sess., National Bureau of Standards, 16 March 1965: 538.

<sup>179</sup> House Committee on Appropriations, Subcommittee on Departments of State, Justice, Commerce, the Judiciary, and Related Agencies Appropriations, *Departments of State, Justice, Commerce, the Judiciary, and Related Agencies Appropriations for 1970: Hearings Before a Subcommittee of the Committee on Appropriations*, 91st Cong., 1st sess., National Bureau of Standards, 13 March 1969: 960.

However, this arrangement did not last long. Since the clearinghouse was not a technical or research operation, there was no advantage to its being located in the Bureau. On September 2, 1970, it became a separate agency within the Department of Commerce known as the National Technical Information Service, one of the Department's primary operating units.

## INVENTION AND INNOVATION

In 1940, at the suggestion of scientists and engineers, the secretary of commerce formed the National Inventors Council (NIC) to—in the words of Jacob Rabinow—“get the lay inventors (that is, the non-professionals, and perhaps the professionals who are not part of large organizations) to submit inventions to the Government to help the war effort.” The NIC also provided advice to the secretary with regard to the field of invention. Serving without pay, the Council received over 500 000 submissions during the war years, 106 of which actually went into production.<sup>180</sup> Then, in 1964, the Bureau formed a small group concerned with invention and innovation in the Office of the Director of the Institute for Applied Technology. Placed under Daniel V. De Simone, an engineer/lawyer who had been a consultant to J. Herbert Hollomon and the Office of Technical Services and was an expert on innovation, a primary function of the group was to reconstitute and serve as secretariat for NIC. In the same year, in his Economic Report to the Congress, President Johnson directed DOC “to explore new ways for speeding the development and spread of new technology.” To help carry out the president's directive, the secretary of commerce formed a Panel on Invention and Innovation, and “[b]ecause one of the ways a government can accomplish this end [the spread of technology] is to improve the climate for technological change,” the secretary asked the panel “to explore the opportunities for improving such climate-setting policy areas as anti-trust, taxation, and regulation of industry.”<sup>181</sup> De Simone's group in IAT provided a secretariat for the panel. In February 1965, the NBS group became an office. So was born the Office of Invention and Innovation (OII).

The aim of the Office was to “help develop an environment more conducive to technological change.” It did this in three separate ways: by “providing a more rational basis for the formulation of climate-setting Federal policies,” by offering programs to help inventors, and by education.<sup>182</sup> In 1965, OII reconstituted NIC, which adopted a new charter and appointed De Simone as its executive director. Composed of fourteen outstanding inventors from the private sector and fourteen observers from various Government agencies, NIC was now “concerned with the processes of invention, the work of inventors, and ways to provide more effective assistance to them through state,

---

<sup>180</sup> Jacob Rabinow, “Diamond Ordnance Fuze Laboratory and National Inventors Council,” in *NBS/NIST, A Historical Perspective; A Symposium in Celebration of NIST's Ninetieth Anniversary, March 4, 1991*, Karma Beal, ed., Natl. Inst. Stands. Technol. (U.S.) Special Publication 825; (April 1992): 59.

<sup>181</sup> The fifteen-member panel was under the chairmanship of Robert A. Charpie, President of Union Carbide Electronics, and De Simone was the Executive Secretary. The panel wrote a report entitled, *Technological Innovation: Its Environment and Management*, Daniel V. De Simone, ed. (Washington, D.C.: GPO, 1967): 1.

<sup>182</sup> Annual Report for 1966: 93.

regional, and Federal invention programs." It served "as a forum for the views of inventors on issues concerning creativity and the conception, development, and application of inventions to the needs of society."<sup>183</sup>

In 1965, OII organized and then published the proceedings of a conference on creative engineering education, one of the types of activities it took on as an arm of NIC. The conference was inspired by NIC, and support for it also came from the National Academy of Engineering and the National Science Foundation.<sup>184</sup> The NIC also issued reports. For example, a report for the President's Commission on the Patent System gave the inventor's view of that system.<sup>185</sup>

Another of the main activities of the office was helping the states to assist inventors. The office encouraged states to hold expositions and congresses at which inventors and industry could meet and explore the value of specific inventions. With direct advice and assistance from OII, twelve states held such congresses in 1965, thirteen did in 1966, and twenty-one did in 1967. The office also provided assistance to the Organization of American States in designing a "strategy for the technological development of Latin America."<sup>186</sup>

Perhaps the most constant concern of OII was education, an area of great interest to the inventor's council. OII and the council's concern was that the necessary factual content of traditional engineering education should not stifle original or unconventional approaches to solving problems. The OII cooperated with universities, holding seminars and symposia with the aim of stimulating changes in the engineering curricula to emphasize the process of invention and innovation.<sup>187</sup>

In 1967, the Panel on Invention and Innovation issued its report. Concerned with taxation, finance, and competition, the panel found "no need to recommend any major changes in the present laws governing these three areas." It did, however, make seventeen specific recommendations, ranging from the handling of financial losses incurred by small technology-based companies to the application and clarification of anti-trust laws. It also recommended that DOC serve as the Federal spokesman for technology-based enterprises. Clearly, OII was an effort in that direction.<sup>188</sup>

All this time, in keeping with its original role, NIC continued to receive inventions, and the Bureau staff analyzed each one. Most of the 625 000 submissions received by the NIC during its lifetime were of no value. There was, for example, the occasional perpetual motion machine. But if an invention seemed to have merit, the inventors were directed to possible avenues for development.<sup>189</sup>

---

<sup>183</sup> Memorandum, A/S for Science and Technology to the Secretary, "Renewal of Charter for the National Inventors Council as Required by Departmental Order No. 114 (Revised)," May 12, 1969. (NIST RHA; Director's Office; Box 388; Folder May-June 1969)

<sup>184</sup> *Education for Innovation*, Daniel V. De Simone, ed. (Oxford: Pergamon Press, 1968): vii-ix.

<sup>185</sup> Annual Report for 1967: 107.

<sup>186</sup> Annual Report for 1969: 164.

<sup>187</sup> For an in-depth analysis of the education problem see Daniel V. De Simone, "Education for Innovation," *IEEE Spectrum* 5 (January 1968): 83-89.

<sup>188</sup> Ad Hoc Panel on Invention and Innovation, *Technological Innovation*: 34-57.

<sup>189</sup> Rabinow, "Diamond Ordnance Fuze Laboratory and National Inventors Council": 59.

OII grew from a small group to an organization of twenty persons in 1969, but then dropped to half that size as the office undertook Department-wide PPB functions.<sup>190</sup> In 1974, Assistant Secretary for Science and Technology Betsy Ancker-Johnson abolished NIC, feeling that its work was largely completed and that she could obtain sufficient advice from other sources.<sup>191</sup> The dissolution of NIC removed one of the prime reasons for the existence of OII. But almost immediately a reason arose for the enlargement of one type of the activities carried on by OII. On the last day of 1974, the president signed into law the Federal Nonnuclear Energy Research and Development Act of 1974. In a very short section entitled "Energy-Related Inventions," the Bureau was assigned a new function, or perhaps it can be said that an old activity was given a legal basis. The section read:

The National Bureau of Standards shall give particular attention to the evaluation of all promising energy-related inventions, particularly those submitted by individual inventors and small companies for the purpose of obtaining direct grants from the Administrator [of the Energy Research and Development Administration, now the Department of Energy]. The National Bureau of Standards is authorized to promulgate regulations in the furtherance of this section.<sup>192</sup>

On March 30, 1975, the Office of Energy-Related Inventions was established in the Office of the Director of IAT, with George P. Lewett as director. The original OII continued operating, but not for long.<sup>193</sup> On July 22, 1975, the day that the Technical Analysis Division was abolished, the OII was abolished as well. The sole responsibility of the Bureau with regard to inventions was now the evaluation of those related to energy. The program continued in collaboration with the Department of Energy and was known as the Energy-Related Inventions Program in the Office of Technology Innovation. From 1975 to the program's demise in 1998, over 33 000 inventions were evaluated with more than 700 considered sufficiently promising to be recommended to the Department of Energy for commercialization support. Of these, more than 130 achieved commercial success with gross market sales of more than \$1 billion.<sup>194</sup>

<sup>190</sup> Appropriations Hearings for 1970: 961-962; Annual Report for 1969: 163.

<sup>191</sup> Rabinow, "Diamond Ordnance Fuze Laboratory and National Inventors Council": 59.

<sup>192</sup> *Federal Nonnuclear Energy Research and Development Act of 1974, U.S. Statutes at Large*, 88 (1974): 1894.

<sup>193</sup> Department of Commerce, National Bureau of Standards, "Organizational Changes—Divisions 129 and 400," *Administrative Bulletin* 75-12, March 27, 1975.

<sup>194</sup> Computations of social rates of return (SRR) from data collected over the period 1980-1994 by Oak Ridge National Laboratory show that ERIP's SRR compares favorably with those of other NIST programs. Data and citations used in computation of SRR are found in R. B. Braid, Jr., M. A. Brown, C. R. Wilson, C. A. Franchuk, and C. G. Rzy, *The Energy-Related Inventions Program: Continuing Benefits to the Inventor Community*, Oak Ridge National Laboratory Report ORNL/CON-492 (October 1996). Table of SRR for twelve NIST technology areas is found in Gregory Tassey, *Rates of Return from Investments in Technology Infrastructure*, Natl. Inst. Stand. Technol. (U.S.) Planning Report 96-3; June 1996: 21.

In its budget submissions for FY 1970, the Bureau placed both the Clearinghouse for Federal Scientific and Technical Information and the Office of Invention and Innovation in its special central responsibilities category of obligations that had no direct relationship to its measurement standards mission. While many inventions were byproducts of its measurement mission, most occurred as part of its regular research or as part of its work for other agencies. The aim of trying to increase innovation by stimulating and easing the processes of invention did not seem to follow from the measurement standards mission.<sup>195</sup> However, the aim of improving technology development and its diffusion would become an increasingly important part of the Bureau's activities, eventually transforming it into a wholly different institution.

### **A DIRECTOR RETIRES**

In 1967, Allen Astin turned 63 and was looking forward to retiring at age 65. By then, he would have served as director for seventeen eventful years, from the traumatic AD-X2 events of his first years to the rewarding ones during the building and occupancy of the Gaithersburg facility. The institution he would be leaving was far different from the one he had inherited. No longer did 85 percent of its income derive from work for other agencies; now it was a more reasonable 40 percent. Astin had seen the Bureau through the most sweeping organizational change in its history and had given it a new definition of its mission. Whole organizational units had been spun off, but the institution was not materially smaller. Most important, all major organizational units were headed by new young leaders whom, as director, Astin had led throughout their years at the Bureau. It was an opportune time to yield the reins to a younger person.

Astin had chosen that person. He was Lewis M. Branscomb, founder of JILA and chief of the Laboratory Astrophysics Division. Branscomb had already had an illustrious career. Born in Asheville, North Carolina, on August 17, 1926, he attended Duke University, from which he received an A.B. degree summa cum laude in 1945. He served as an officer in the Naval Reserve with one year of duty in the Philippines. After the War, Branscomb entered Harvard University, earning an M.S. in 1947 and a Ph.D. in physics in 1949. After two years as a Junior Fellow in the Harvard Society of Fellows, the young scientist came to the Bureau as one of Condon's new minds. Branscomb was eventually appointed chief of the Atomic Physics Section of the Atomic and Radiation Physics Division, and upon the split of that entity, became chief of the Atomic Physics Division. He was the founder of JILA and, as Astin contemplated his retirement, was serving as chief of the Laboratory Astrophysics Division in Boulder.

---

<sup>195</sup> The aim of the program was not actually to develop technology. This would have put it into competition with the private sector. The perception that this competition existed was the reason for the difficulties encountered by the Civilian Industrial Technology (CIT) program. Although not directed at particular industrial sectors, both the inventions and innovation program and the clearinghouse activity were, in fact, the types of activities envisaged for CIT.

But listing Branscomb's Bureau accomplishments does not do him justice. He was widely known and active in the scientific community. He served on the President's Science Advisory Committee. Although he served as an independent person, not an official representative of an agency, he was the first civil servant to serve on that committee. Branscomb served on the Defense Science Board in 1968 and 1969, resigning when he became director of the Bureau. He served as a special consultant to the secretary general of the Organisation for Economic Co-operation and Development and participated in the International Union for Geodesy and Geophysics, the International Union of Pure and Applied Physics, and the International Astronomical Union. He was a member of the American Academy of Arts and Sciences, served on the Board of Directors of the American Association for the Advancement of Science, and, upon becoming director of the Bureau, served on the board of the American National Standards Institute. Branscomb then became a member of the National Academy of Sciences. He had been chairman of the Division of Electron and Atomic Physics of the American Physical Society and was now the editor of *Reviews of Modern Physics*. He had been an instructor in physics at Harvard (1950-51), lecturer in physics at the University of Maryland (1952-54), visiting staff member at the University College, London (1957-58), and adjoint professor of physics at the University of Colorado (1962-69). He was the recipient of many awards, among them the Rockefeller Public Service Award, the Arthur Fleming Award of the D.C. Junior Chamber of Commerce, the DOC Gold Medal, and the Bureau's own Stratton Award. He was married to the former Anne Wells and had two children, Harvie and Katharine.

As early as September 1967, Secretary of Commerce Alexander B. Trowbridge and Assistant Secretary Kincaid, doubtless spurred by Astin, were anxious to get Branscomb nominated as director. It was known that Astin would retire upon reaching his 65th birthday in 1969, after the 1968 election with the possibility of loss by the incumbent Democratic administration. The Branscomb partisans had to take some action before the forthcoming elections. One possibility was to have Astin accept a "senior advisory role" for several months in order that Branscomb might be made director before that time.<sup>196</sup> Astin, however, adamantly refused. He would retire from the position of director.

Another possibility was that Branscomb could be appointed deputy director, either before or after the retirement of Irl Schoonover, which was expected in 1968.<sup>197</sup> In a memorandum to Trowbridge, Kincaid concluded, "I suggest that we try to interest Dr. Branscomb in the Directorship, but it looks as though we will have to put it on the basis that he will have to take his chances with respect to becoming Director in 1969, if he starts as Deputy Director in 1968." Responding to a note from Kincaid, Branscomb indicated that he did not want any part in such schemes. "I think it is not

---

<sup>196</sup> Memorandum, John F. Kincaid to The Secretary, "Directorship of NBS," September 26, 1967. (DOC; Assistant Secretary for Science and Technology; Accession 40-72A-7166; Box 8; Folder Chron File (August-September 1967) JFK)

<sup>197</sup> Schoonover's retirement did not actually occur until 1969.

useful to the Bureau of Standards for me to make a commitment at this time which might serve to tie the Secretary's hands should there be a change in administration or for any other reason in the departmental leadership." More correspondence followed. Yet Branscomb's position regarding the deputy director position remained unchanged. However, despite his disapproval of the particular strategy that Kincaid proposed, Branscomb was not totally opposed to the idea of assuming the directorship. Even though his daughter, who suffered from asthma, might not be able to "live in good health for continuous periods in the Washington climate," Branscomb and his wife were prepared to try to work it out. He regarded his "possible appointment as NBS Director with the utmost seriousness."<sup>198</sup> The secretary told Branscomb, "I share his [Kincaid's] faith in NBS, and his desire that it obtain the type of top flight leadership you can provide when the time becomes propitious."<sup>199</sup>

The time never did become propitious. Nixon defeated Humphrey in 1968, and the Republican Party took over the White House. Although it was customary that political affiliations did not bear greatly on decisions concerning the appointment or retention of the Bureau director, they were not completely ignored. Certainly they were not in Branscomb's case. In particular, Anne Branscomb, a lawyer by profession, had become state chairwoman of the Democratic Party in Colorado and hence a member of the Democratic National Committee.<sup>200</sup> Branscomb himself, while a Democrat, was basically apolitical. His wife's affiliation, however, was to prove somewhat of a stumbling block.

Astin did not let the change in administration stand in the way of having his chosen successor become the next director of the Bureau. Whether he did it himself or via the visiting committee or by some other means is not known, but somehow Branscomb's name found its way to the White House. That Branscomb had served on one of Nixon's transition teams—the Technology Transition Group—apparently had nothing to do with it. Shortly after Christmas 1968, Astin told Branscomb that he was "trying to rig this" for him to become director. Branscomb, still ambivalent about assuming the post and quite happy with being a division chief and with his JILA/University position, said, "Look, I don't want to be the Director, but if you rig it, I owe you so much, I won't turn it down. I'll do it."

But the problems caused by Anne Branscomb's affiliation still had to be overcome. As Branscomb recounted it in an interview, "they [the White House] looked me up and discovered not only was I a Democrat, my wife was on the DNC [Democrat National Committee]. That didn't go down too well. The reason it didn't go down too well is because the chairman of the Republican Party in Colorado was a man named John Flanigan. . . . His brother was Peter Flanigan, the investment banker. Peter Flanigan

---

<sup>198</sup> Letter, L. M. Branscomb to J. F. Kincaid, January 27, 1968. (DOC; Assistant Secretary for Science and Technology; Accession 40-70A-6988; Box 35; Folder National Bureau of Standards-General 1966-68)

<sup>199</sup> Letter, A. B. Trowbridge to L. M. Branscomb, February 7, 1968. (DOC; Assistant Secretary for Science and Technology; Accession 40-70A-6988; Box 35; Folder National Bureau of Standards-General 1966-68)

<sup>200</sup> Interview with Lewis M. Branscomb, July 12, 1988: 45-51. (NIST Oral History File)

was a close Nixon confidante.” John Flanigan, at the insistence of the White House, had reluctantly agreed to the appointment in the Nixon Administration of a Democrat from Colorado and was smarting as a result. He would have no more Democrats. Branscomb continued, “Whoever was trying to engineer my appointment, whether it was [newly appointed Secretary of Commerce Maurice] Stans or whoever Astin’s intermediaries were, went to Peter Flanigan and persuaded Peter to persuade his brother. I later became a good friend of Peter Flanigan, and he told me that that’s what happened.”

With that stumbling block out of the way, Branscomb was called to meet with Secretary Stans. He remembered, “I went into his big office and sat down. Marty Stans said to me the following thing, more or less in these words. He said, ‘Dr. Branscomb, you have a fine reputation and a lot of people have told me you’re a great scientist and so forth, and that you are not only qualified to be the director of the Bureau of Standards, but that you are the best qualified person anywhere to be the director of the Bureau of Standards, and that I’d be making a terrible mistake if I didn’t appoint you director of the Bureau of Standards.’ He said, ‘I’m prepared to do that, but you and I need to have an understanding.’ I said, ‘Sure, what’s that?’ He said, ‘I’m sure what the Bureau of Standards does is very important. I don’t really know much about what it is. I don’t really expect to get very involved in what the Bureau of Standards does. If you will run the Bureau of Standards competently, keep it out of trouble, do whatever it’s supposed to do and do it well, and you will recognize that the reason I’m here and the only reason I’m here as secretary of commerce, is to raise money for Nixon’s re-election in 1972, and you don’t get in my way in this task, we’ll get along fine.’ I said, ‘Mr. Stans, you’ve got nothing to worry about. . . . We’ll get along just fine.’” In fact, Branscomb recalled that “Stans, once in office, took considerable pride in the Department and vigorously defended its interests.”<sup>201</sup>

Lewis Branscomb was nominated by President Nixon on June 17, 1969 and confirmed by the Senate on August 7, 1969, more than three weeks before Astin left office on August 31. Branscomb became the Bureau’s sixth director on September 1.

## STANDARDS MATTERS

The standards activities of the three institutes illustrate well the differences in emphasis among them. Thus, as its name implies, the Institute for Basic Standards (IBS) had responsibility for the basic units—standards of mass, length, time, temperature, the ampere, the candela—and the quantities derived from them. Then, in the 1964 reorganization, the Office of Standard Reference Materials (OSRM) was placed in the Institute for Materials Research (IMR) which also inherited the Analytical Chemistry Division, by far the largest producer of SRMs. The Institute for Applied Technology (IAT) took over the commodity standards program and, via the Building Research Division, took on the building codes and standards activities, as well as fire standards

---

<sup>201</sup> Letter, Lewis M. Branscomb to Elio Passaglia, March 8, 1993. (NIST History Project File; Chapter 5; Folder “LMB Director”)



work. With passage of the Brooks Act, IAT was given the responsibility for the development of what came to be called Federal Information Processing Standards (FIPS). This is not to say that the work was completely compartmentalized. Development and production of SRMs took place throughout the Bureau, as for example in the Polymers Division, which produced molecular-weight SRMs. And in the Cryogenics Division, even while it was part of IMR, studies on the use of the Josephson effect for the extension of the temperature scale to the millikelvin range took place.<sup>202</sup> It should be borne in mind further that representatives from virtually all NBS units served on one or more of the numerous committees of standardization organizations such as ASTM and ASME.

In this section on standards matters we give illustrations of noteworthy work that was carried out in these different areas, with emphasis on the basic standards activities, which was the Bureau's unique function.

### **Lasers and New Vistas in Metrology**

The very high coherence and brightness of lasers makes them practically ideal instruments for length measurements. Thus the work on length during the period took three different directions: the use of continuous-wave lasers for measuring moderately long (50 m) lengths by interferometry with direct counting of fringes; the use of pulsed lasers for the measurement of very long distances by the use of radar-like techniques; and a study of the wavelength stability and reproducibility of lasers as possible replacement of the krypton-86 wavelength standard for the meter. Alongside these three lines of activity was a related effort to make an absolute measurement of the frequency of laser light. In due course that effort, along with the stabilization of laser wavelength, would lead to a definition of the meter based on the velocity of light.

We now take up the use of lasers for the interferometric determination of length.<sup>203</sup> We saw in Chapter 4 how an interference pattern using a helium-neon laser was obtained over a 100 meter path. But that laser was unstable due to several technical factors and, as a result, so was the interference pattern. For further experiments it had to be improved. This was done by keeping the laser operating in a single mode by adjustment of the power supply, by making the cavity rugged and rigid, and by tuning the cavity length piezoelectrically to keep the resonance at the center of the neon line. There was no electronic feedback stabilization.

The laser was then turned to a very practical problem. The calibration of graduated length scales (really nothing but very fancy and precise rulers) was a very tedious and lengthy process. In the proposed method, the laser would be used as the light source

---

<sup>202</sup> The Cryogenics Division, located in Boulder, was first placed in IMR, but because all other Boulder units (except for the CRPL, which was lost in the formation of ESSA in 1966) were in IBS, it also was moved to IBS for administrative simplicity.

<sup>203</sup> There are quite a few publications on this topic. Those that were found useful in preparing this account are: K. D. Mielenz, H. D. Cook, K. E. Gilliland, and R. B. Stephens, "Accurate Length Measurement of Meter Bar With Helium-Neon Laser," *Science* 146 (1964): 1672-1673; K. D. Mielenz, "Length Measurement and Laser Wavelength Stability," *ISA Transactions* 6 (1967): 293-297; "Line-Standard Interferometer: For Accurate Calibration of Length Scales," *Technical News Bulletin* 51 (1967): 43-45; "International Study of Laser Wavelength," *Technical News Bulletin* 52 (1968): 95-96.

for a Michelson interferometer to be used for the automatic calibration of such scales. Due to the high coherence of the laser light, it would be very easy to obtain an interference pattern over the whole one-meter length of these precision rulers. Then, counting the interference fringes as one of the mirrors in the interferometer was moved from one end to the other of the item to be calibrated, would give the total length of the item. Calibration could also be accomplished at any intermediate position.

To carry out this process, the item to be calibrated was firmly fastened to the carriage of a massive way-bed—really the frame for a linear dividing engine. One mirror of the interferometer was fixed near a stationary microscope and the other was located on a movable carriage driven by a long screw and carrying the scale. The fringes were produced at a photoelectric counter. As the carriage moved, the interference fringes passed across the photoelectric cell and were counted. There was built into the instrument an automatic pause and centering option (by feedback from the microscope) at each graduation on the ruler, and an automatic recording of the fringe count, interpolated to 0.01 fringe. An automated system was at hand. All that was necessary now was to accurately determine the wavelength of the laser.



Herbert D. Cook (left) of the NBS Electronic Instrumentation Laboratory controlled the automatic operation of a fringe-counting interferometer (not shown). The count was shown on the monitor console (center).

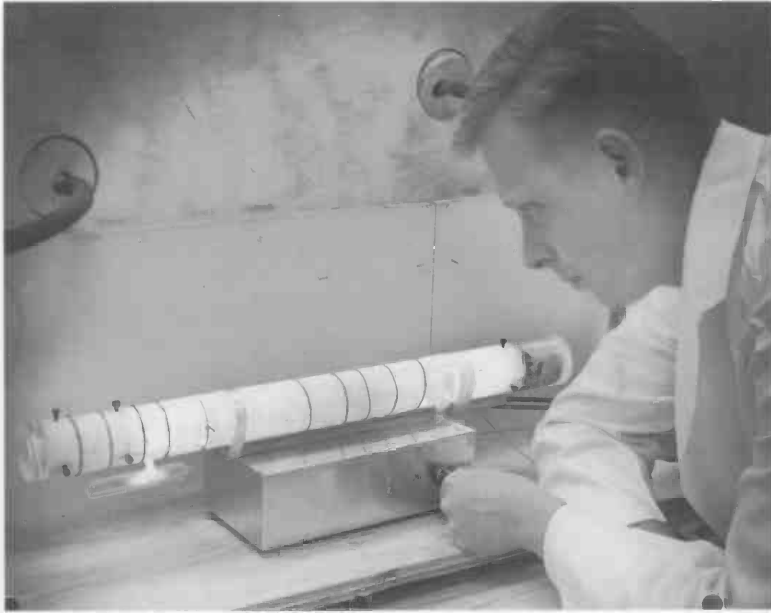

In the measurement of length with a laser to better than 1 part in 10 million, Klaus D. Mielenz matched the impedance of the rf-power supply to that of the laser.

Comparison with a mercury-198 light source (a primary standard of length used in place of krypton-86) by counting fringes over a calibrated decimeter line standard gave the wavelength of the laser. The practicable length over which an interference pattern could be obtained with such a source was about three decimeters. Then, counting fringes with the laser source over the length of a standard meter bar reproduced the length of the bar to 1 part in ten million. It was excellent accuracy, and all produced automatically.

On the basis of these results the Bureau offered an improved and much less costly calibration service for graduated length scales. If the graduations were sufficiently fine, the calibration relative uncertainty offered was  $\pm 1 \mu\text{m}/\text{m}$  (1 part per million). Improvements in the measurement process had reduced the relative uncertainty to  $\pm 60 \text{ nm}/\text{m}$  (6 parts in 100 million) by 1998.

To check the stability and reproducibility of the helium-neon laser, an international study involving the Bureau, the British National Physical Laboratory, and the German Physikalisch-Technische Bundesanstalt was carried out. While the study showed that the different laboratories agreed within 5 parts in  $10^9$  in wavelength measurements when they measured the same laser—even though they used different methods—measuring different lasers of the same type could give quite different results. The wavelength for an uncalibrated laser could not be presumed to have a relative uncertainty of less than 1 part in ten million. Regular calibration was called for, and the Bureau considered offering a laser calibration service.

\* \* \*

When the Apollo 11 astronauts left the lunar surface they left behind a 46 cm × 46 cm aluminum panel in which 100 carefully crafted 3.8 cm in diameter fused-silica corner-cube retroreflectors were mounted. These were to be used to reflect back to its origin a very short laser pulse sent up from Earth. The plan was to measure very precisely the travel time of the pulse and from this to calculate with great precision the earth-moon distance.<sup>204</sup> From the determination of this distance it would be possible to refine such lunar orbital parameters as mean distance and eccentricity, and such geophysical data as the earth's period of rotation, the motion of the pole and, after five years of observation, to determine the east-west rate of continental drift. The initial uncertainty of the lunar distance determination was expected to be  $\pm 15$  cm.

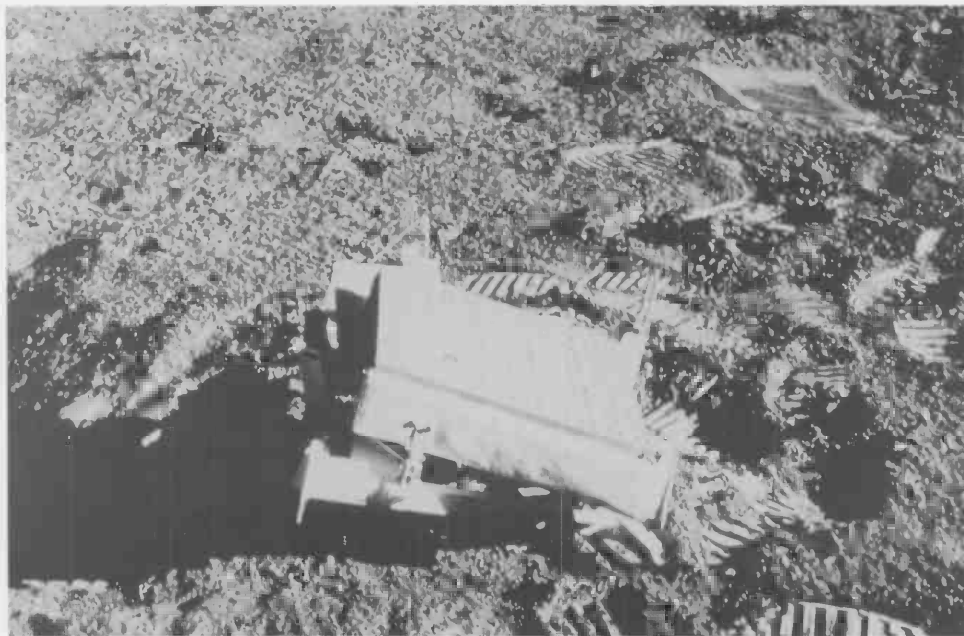

The Apollo 14 mission in 1971 left a second corner-cube retroreflector array on the lunar surface. The Apollo 11 and Apollo 14 retroreflector packages were deployed at well-separated sites near the lunar equator. These arrays were expected to yield an extended sequence of high-precision earth-moon distance measurements and thus provide a variety of information about the earth-moon system.

<sup>204</sup> The information presented here comes from two publications: J. E. Faller, I. Winer, W. Carrion, T. S. Johnson, P. Spadin, L. Robinson, E. J. Wampler, and D. Wieber, "Laser Beam Directed at the Lunar Retro-Reflector Array: Observations of the First Returns," *Science* 166 (1969): 99-102; and C. O. Alley, R. F. Chang, D. G. Currie, S. K. Poultney, P. L. Bender, R. H. Dicke, D. T. Wilkinson, J. E. Faller, W. M. Kaula, G. J. F. MacDonald, J. D. Mulholland, H. H. Plotkin, W. Carrion, and E. J. Wampler, "Laser Ranging Retro-Reflector: Continuing Measurements and Expected Results," *Science* 167 (1970): 458-460.

It was a conceptually simple, though in-practice complicated, experiment in which the Bureau had been involved from the beginning—indeed, from the origin of the idea.<sup>205</sup> Briefly, in December 1962, James E. Faller, recent Princeton graduate, came to work with Peter L. Bender at JILA as a post-doctoral research associate. Faller, having used corner-cube retroreflectors in his thesis work, brought to NBS the draft of a paper on how corner-cube retroreflectors on the moon could be used to measure the distance to the moon by timing the round-trip travel time of reflected laser pulses. But laser technology in those early days was primitive, and Bender discouraged Faller from publishing his paper. However, as laser technology progressed, Faller's idea became more attractive, and a group of seven people published an article on the topic and made a proposal to NASA.<sup>206</sup> By then, all space for experiments on all planned Apollo flights had been committed, but some of the tasks assigned to the astronauts were thought to be too tiring. However the emplacement of the retroreflector holding plates was easy, and through this fortunate circumstance, Apollo 11 carried the retroreflector package and the astronauts emplaced it on the moon.

It did not take long for results to come. On August 1, 1969, just eleven days after the astronauts left the lunar surface, the first laser return signals were observed. To accomplish this, 7-joule pulses of light from a ruby laser were transmitted through the 120-inch telescope at the Lick Observatory. Even with a telescope of this size, the diameter of the beam at the lunar surface was still approximately 3.2 km, and the reflected return signal amounted to only slightly more than one photoelectron per pulse at the photomultiplier detector. The range accuracy on this first experiment was about 15 m. By October, regular data were coming from the McDonald Observatory, which was instrumented to be this country's lunar laser-ranging station. The initial range uncertainty was  $\pm 30$  cm. This subsequently improved to  $\pm 15$  cm and now—some years later—to  $\pm 2$  cm.

\* \* \*

The other laser-length activity carried out during the period was not concerned with measuring length, but on the ambitious aim of replacing the krypton-86 wavelength as the international length standard with radiation from a laser.<sup>207</sup> From the early days of lasers it was shown that the intrinsic bandwidths of essentially all gas lasers were one Hz or less, and observable bandwidths of a few tens of Hz were obtainable, limited primarily by mechanical and thermal disturbances. Such widths correspond to an uncertainty in the frequency of about one part in  $10^{13}$ .

---

<sup>205</sup> Interview with Peter L. Bender, May 12, 1987. (NIST Oral History File).

<sup>206</sup> C. O. Alley, P. L. Bender, R. H. Dicke, J. E. Faller, P. A. Franken, H. H. Plotkin, and D. T. Wilkinson, "Optical Radar Using a Corner Reflector on the Moon," *Journal of Geophysical Research* 70 (1965): 2267-2269. Faller left the Bureau in 1966 to accept a position at Wesleyan University. He remained very active in the lunar laser-ranging experiment and returned to the Bureau in 1972, rejoining the JILA staff.

<sup>207</sup> The physics background on why this was an attractive possibility and the problems of implementing it were reviewed by J. L. Hall, "P-1—The Laser Absolute Wavelength Standard Problem," *IEEE Journal of Quantum Electronics* QE-4 (1968): 638-641.

But this is for an operating laser. Resetting the laser, or constructing another one, could only be done with an uncertainty of one part in  $10^9$ . This is about four decades worse than the resolution limit, and not better than the performance of the krypton-86 standard. To make good use of lasers, the resettability problem had to be solved.

As seen above, an uncalibrated helium-neon laser is likely to have an intolerable uncertainty of one part in  $10^7$  and, if calibration is required, such a laser cannot be a primary standard. Hence servomechanism methods of self stabilizing to the center of the emission line were tried, but the presence of Stark shifts, Zeeman shifts, Doppler shifts, and pressure broadening and shifts could cause problems for a primary standard. Various other schemes were tried to stabilize the laser, but the most promising was "based on the sharp-line absorption of laser light by suitable molecules." Molecules have rich vibrational-rotational spectra, so that the probability of finding a line within the tuning range of the laser (2 to 3 parts per million) is relatively high.

The methane absorption line at  $3.39 \mu\text{m}$  was the one chosen for study by Richard L. Barger and John L. Hall at JILA for the stabilization of a  $3.3 \mu\text{m}$  He-Ne laser.<sup>208</sup> It is a line that has a number of good features, such as being thermally well populated, and having a long natural lifetime and a high absorption. Its frequency is 100 MHz higher than the center of the  $3.9 \mu\text{m}$  He-Ne laser line center, but the laser line can be pressure-shifted to be in exact coincidence with the methane absorption. Perhaps most important, when saturated by the laser field, the linewidth obtained can approach the very sharp natural linewidth without Doppler broadening.

Experiments were set up in an underground vault to minimize environmental disturbances, using a three-ton cast-iron table for further stability. Three lasers were used in the experiments. Two contained the methane absorption cell in their cavity, while the third served as a local oscillator. Using a feedback system too complex to be described here, Barger and Hall found that their two lasers containing the methane cell, independently locked to the methane frequency, differed in frequency by only 1 part in  $10^{11}$ , about 2.5 orders of magnitude better than the krypton-86 primary standard. One of the keys to opening the door to a completely new primary standard of length was in hand.

\* \* \*

One basic standard activity that involved lasers dealt not with length, but with time. More precisely, it was concerned with the measurement of the frequency of laser light. Again, this was not merely a display of experimental virtuosity—it had a very specific purpose. If the measurement of frequency—the most accurate measurement available to science—could be extended without too great a loss in accuracy to a region in which the wavelength of the radiation could also be compared to the krypton-86 standard, then a value of the velocity of light could be determined in which the principal uncertainty was that in the length standard. This in turn would lead to the possibility—or necessity—of redefining the meter.

---

<sup>208</sup> R. L. Barger and J. L. Hall, "Pressure Shift and Broadening of Methane Line at  $3.39 \mu$ . Studied by Laser-Saturated Molecular Absorption," *Physical Review Letters* 22 (1969): 4-8.

The first determination of the absolute frequency of a laser line was made with the 311  $\mu\text{m}$  and 337  $\mu\text{m}$  transitions of a CN gas laser.<sup>209</sup> What was done was to beat the laser output against the 12th or 13th harmonic of a klystron operating near 75 GHz, the 12th harmonic for the 337  $\mu\text{m}$  line and the 13th for the higher-frequency line. Heterodyning was carried out on a commercial cat's-whisker/silicon-rectifier harmonic crystal mixer. The fundamental frequency of the 75 GHz klystron was measured by comparing it to the frequency of another klystron locked to a signal generator, and the observed frequencies of the CN laser were determined as 890.7595 GHz and 964.3123 GHz with a relative error of "a few parts in  $10^7$ ."

In rapid order, the frequencies of shorter and shorter wavelength lasers were determined: 1578.279 GHz for a 190  $\mu\text{m}$  D<sub>2</sub>O laser, 1539.756 GHz for a 194  $\mu\text{m}$  C<sub>2</sub>N<sub>2</sub> laser, and 2527.9528 GHz for a 118.6  $\mu\text{m}$  water vapor laser.<sup>210</sup> To go beyond this frequency a new method had to be devised. Such high harmonics of the klystron frequency had to be used that the signal-to-noise ratio suffered greatly. Something new was required. Since the absolute frequencies of some lasers were now known, they could be used in a frequency multiplier chain.<sup>211</sup> To this end, the harmonics of a 337  $\mu\text{m}$  laser could be mixed with the laser to be measured, and a microwave signal supplied to make up the difference between the two. This technique was first tested on the known 118  $\mu\text{m}$  water-vapor laser and then extended to the frequency of the 84  $\mu\text{m}$  D<sub>2</sub>O laser.<sup>212</sup>

Up to this point, all the cited work had been done outside the Bureau. But now work at the Bureau went ahead on two fronts. The first, under the direction of Kenneth M. Evenson of the Radio Standards Division in Boulder, followed the paths already described, while another effort under the direction of Zoltan Bay in Gaithersburg took another direction. It did not achieve the accuracy of the Evenson group effort, and did not lead to new standards, but it is included here for historical completeness.

The Evenson group reached the highest frequency measurement obtained up to that time using an experimental arrangement similar to that used by L. O. Hocker, James G. Small, and Ali Javan, but a metal-on-metal diode—a small but critical item—replaced the metal-on-silicon diode. The results were  $3.821\,775 \pm 0.000\,003$  THz and  $10.718\,073 \pm 0.000\,002$  THz for the 78  $\mu\text{m}$  line and the 28  $\mu\text{m}$  line respectively.<sup>213</sup>

<sup>209</sup> L. O. Hocker, A. Javan, D. R. Rao, L. Frenkel, and T. Sullivan, "Absolute Frequency Measurement and Spectroscopy of Gas Laser Transitions in the Far Infrared," *Applied Physics Letters* 10 (1967) 147-149.

<sup>210</sup> L. O. Hocker, D. R. Rao, and A. Javan, "Absolute Frequency Measurement of the 190 $\mu$  and 194 $\mu$  Gas Laser Transitions," *Physics Letters* 24A (1967) 690-691; L. Frenkel, T. Sullivan, M. A. Pollack, and T. J. Bridges, "Absolute Frequency Measurement of the 118.6- $\mu\text{m}$  Water-Vapor Laser Transition," *Applied Physics Letters* 11 (1967): 344-345.

<sup>211</sup> L. O. Hocker and A. Javan, "Laser Harmonic Frequency Mixing of Two Different Far Infrared Laser Lines up to 118  $\mu$ ," *Physics Letters* 26A (1968):255-256.

<sup>212</sup> L. O. Hocker, J. G. Small, and A. Javan, "Extension of Absolute Frequency Measurements to the 84  $\mu$  Range," *Physics Letters* 29A (1969): 321-322.

<sup>213</sup> K. M. Evenson, J. S. Wells, L. M. Matarrese, and L. B. Elwell, "Absolute Frequency Measurements of the 28- and 78- $\mu\text{m}$  cw Water Vapor Laser Lines," *Applied Physics Letters* 16 (1970): 159-162.

Almost immediately this frequency record was broken.<sup>214</sup> Despite severe difficulties with the diode detectors, Evenson and his group were able to measure the frequencies of the 10.6  $\mu\text{m}$  lines of the  $\text{CO}_2$  cw laser. For this experiment, the  $\text{CO}_2$  radiation was mixed with the just-measured 78  $\mu\text{m}$  and 28  $\mu\text{m}$  radiations of the water-vapor laser, and again the difference made up with a klystron. The results for the two  $\text{CO}_2$  lines were 28.359 800 THz and 28.306 251 THz, with an uncertainty of  $\pm 0.000\ 025$  THz. The frequency reached was still a long way from the visible region of the electromagnetic spectrum, but progress had by no means slowed.

The Bay effort was based on a quite different method. In it, a crystal of potassium dihydrogen phosphate was placed in the laser cavity and used to modulate the laser beam at a microwave frequency. The sum and difference sidebands were passed into a Fabry-Perot interferometer and, using a method involving simultaneous servoing of the laser cavity length and the interferometer length for maximum output, Bay and Gabriel G. Luther were able to measure both the frequency and wavelength of the laser light. With this apparatus and the 632.8 nm He-Ne laser, they made the first measurement of the frequency of visible light.<sup>215</sup> But the method was incapable of the accuracy of the Evenson-Hall method, largely because of the latter's incorporation of the methane-stabilized laser.

### Time Dissemination

In mid July 1963, the Bureau began disseminating time and frequency signals from its two new low-frequency stations—WWVB at 60 kHz and WWVL at 20 kHz—located on a special site at Fort Collins, Colorado. With the low-frequency stations operating, the time was propitious for the relocation to the Fort Collins site of the high-frequency WWV, broadcast from Greenbelt, Maryland, since 1931 at 2.5 MHz, 5 MHz, 10 MHz, 15 MHz, 20 MHz, and 25 MHz. It was a move that had long been planned. In 1964 Congress appropriated \$970 000 for the move, and by late 1965, building construction and the purchase of new equipment were well under way. A set of eight new transmitters, four for 10 kW operation at 5 MHz, 10 MHz, and 15 MHz, and four for 2.5 kW operation at 2.5 MHz, 20 MHz, and 25 MHz, left two transmitters always in a standby mode. The broadcast powers were half the rated power of the transmitters. When the newly relocated WWV began operation at 0000 hours on December 1, 1966, the Bureau's continental time and frequency broadcast facilities were consolidated.<sup>216</sup>

<sup>214</sup> K. M. Evenson, J. S. Wells, and L. M. Matarrese, "Absolute Frequency Measurements of the  $\text{CO}_2$  cw Laser at 28 THz (10.6  $\mu\text{m}$ )," *Applied Physics Letters* 16 (1970): 251-253.

<sup>215</sup> Z. Bay, G. G. Luther, and J. A. White, "Measurement of an Optical Frequency and the Speed of Light," *Physical Review Letters* 29 (1972): 189-192; "Experimental Measurement of Optical Frequency," *Technical News Bulletin* 57 (1973): 14, 17.

<sup>216</sup> Wilbert F. Snyder and Charles L. Bragaw, *Achievement in Radio: Seventy Years of Radio Science, Technology, Standards, and Measurements at the National Bureau of Standards*, Natl. Bur. Stand. (U.S.). Special Publication 555; October 1986: 282; "WWV To Be Relocated," *Technical News Bulletin* 49 (1965): 215.





Beginning on July 1, 1966, WWV, Fort Collins, Colorado, transmitted the services formerly provided from WWV, Greenbelt, Maryland. The facility was partly underground to affect as little as possible the omnidirectional characteristics of its antennas.



Amateur radio operators making contact with each other exchange "QSL" cards to verify the contact and obtain useful information on propagation conditions. On the occasion of WWV's first broadcast from its new facilities in Fort Collins, Colorado, a special first day card was issued to amateurs and shortwave listeners who reported reception.



Radio station WWVH, on the island of Maui in Hawaii. This station broadcast continuous time and frequency standards to the Pacific area with an accuracy of 1 part in 100 million. Technical services included standard radio frequencies, time announcements, standard time intervals, and standard musical pitch.

But in the Hawaiian Islands, WWVH, the Bureau's time broadcast, was in bad shape. Located on a man-made peninsula on the island of Maui, it had been operating since 1948, and now the site on which it was located was being eroded away by the sea. By 1968, the shoreline was only ten feet from the headquarters building and twelve feet from the antenna. Relocation was imperative.<sup>217</sup>

Sites were first investigated inland on Maui,<sup>218</sup> but the search was extended to all the other islands of the Hawaiian chain, and then extended to Guam, the Marshall Islands, Wake, and American Samoa. A site on the Hawaiian island of Kauai was chosen as having the best physical characteristics and availability of services. While near the ocean, it was a natural site little affected by the sea. It was owned by the Navy, so no land purchase was necessary.<sup>219</sup>

For FY 1969, the Bureau requested and received \$700 000 to begin the relocation, and with further appropriated funds, the relocation was completed and broadcasts began July 1, 1971. The new station broadcast on five frequencies, 2.5 MHz, 5 MHz, 10 MHz, 15 MHz, and 20 MHz, and frequency control was provided by broadcasts from WWVL. The broadcasts covered Alaska in the North, New Zealand in the South, a number of the major cities of the Orient, and most of the Pacific Ocean.<sup>220</sup>

<sup>217</sup> Appropriation Hearings for 1969: 1200.

<sup>218</sup> *Ibid.*, 1374-1376.

<sup>219</sup> Appropriations Hearings for 1970: 905.

<sup>220</sup> "New WWVH Facility," *Technical News Bulletin* 54 (1970): 137.

Along with this modernization of facilities came research on dissemination of time signals. Both WWV and WWVH could provide millisecond accuracy with their time signals, but for some users—television and radio stations, power companies, airlines, satellite communications, the military, universities—higher accuracy would be a boon. These latter users typically carried a portable clock from station to station to synchronize their clocks—a cumbersome, slow procedure which could only synchronize one clock at a time. Another system was highly desirable.<sup>221</sup> The Bureau took two paths toward the provision of clock synchronization in the microsecond range.

The primary reason that WWV or WWVH could not provide such high accuracy was a lack of knowledge regarding the path of the radiation.<sup>222</sup> The reason for this was that the propagation of signals from these medium-high frequency sources was via reflection from the ionosphere, the position of which varied from time to time. Hence the high accuracy of the time signal as transmitted was degraded by this lack of knowledge of the path—both its length and the refractive index in it.

Two approaches were taken to solve this problem, one using a satellite in geosynchronous orbit, and the second using the television broadcast system. In both cases the problem was the same. A signal is transmitted from a station controlled by a master clock, such as WWV and WWVH which are both controlled by the Bureau's atomic clock. The time at which this signal is received by a remote "slave" clock is unavoidably delayed, and the accuracy with which the slave clock can be synchronized with the master depends upon how well this delay is known. The delay in turn depends upon the location of the slave, the path length between the master and slave, the refractive index along the path, and the time delay inherent in equipment electronics.

The use of a geosynchronous satellite for the accurate synchronization of clocks was attractive because the bulk of the path is line-of-sight through interstellar space, and because the satellite can service any slave clock in sight of the satellite transmission.<sup>223</sup> In such a system, a signal from the master clock is sent to the satellite where it is received by a transponder and then re-broadcast. Comparison of the time the signal is received with the local (slave) clock gives the difference in time between the slave and master, and the synchronization is completed. The question is the accuracy with which this synchronization—really a form of calibration—can be performed, which in turn "reduces to predicting the propagation delay."<sup>224</sup> The elements that cause the propagation delay, with their estimated uncertainties in microseconds, as determined by Lawrence E. Gatterer, Paul W. Bottone, and Alvin H. Morgan in a series of experiments, are equipment delays on the ground and on the satellite ( $\pm 2$  and  $\pm 1$ ,

<sup>221</sup> "Time Dissemination and Clock Synchronization via Television," *Technical News Bulletin* 54 (1970): 125-126.

<sup>222</sup> L. E. Gatterer, P. W. Bottone, and A. H. Morgan, "Worldwide Clock Synchronization Using a Synchronous Satellite," *IEEE Transactions on Instrumentation and Measurement* IM-17 (1968): 372-378.

<sup>223</sup> The height of the satellite is approximately 23 000 miles.

<sup>224</sup> Gatterer, Bottone, and Morgan, "Worldwide Clock Synchronization Using a Synchronous Satellite": 372.

respectively), location of the master and slave ( $\pm 0.7$  each), satellite range ( $\pm 0.15$  for both the up-link and down-link), propagation through the ionosphere for both up-link and down-link ( $\pm 6$  each), troposphere delays (0.6), and noise ( $\pm 5$ ). The total computed uncertainty was 10.4 microseconds, which means that by this system the time of the slave clock could be compared with the master with this uncertainty. It was about 100 times as good as could be obtained with WWV.

Another system for the accurate dissemination of time was to use broadcast television as the dissemination mechanism.<sup>225</sup> This system was attractive because the bulk of the path carried by network TV broadcast signals was via microwave repeater stations. The transmitter was line-of-sight with the location of the repeaters, and hence the path, accurately known. In this system, a master clock at the originating transmitter encoded the TV signal with the time. At the receiving TV set, this time was compared with that of the local "slave" clock and the difference fed to a decoder which, once each second, displayed on the TV screen the master time and the difference, in nanoseconds, between that time and the time kept by the slave. Measurement of the path delay between the Naval Observatory in Washington, D.C., and the Bureau's Boulder Laboratories in 1969 showed that, for all three networks, the variation over a few months averaged out to somewhat less than one microsecond. Using synchronized clocks at each of the major network broadcasting centers in New York, the technique could potentially be used over most of the United States by an already existing system.<sup>226</sup>

### Mass and Measurement Assurance Programs

By themselves, calibrations are not sufficient to ensure sound measurements. In a typical mass calibration for example, a set of weights is sent to the Bureau and the calibration personnel determine the difference between the nominal values of the weights and their actual mass.<sup>227</sup> This calibrated set of weights is then typically kept by the using laboratory as a "master set," used for calibrations of its working sets, or customer sets if the laboratory is in the calibration business. The master set is perhaps returned to the Bureau periodically for recalibration. This procedure really gives only one unambiguous number—the mass of a weight when it is calibrated by the Bureau. In particular, it does not give the expected uncertainty for any mass measurements using the weights, unless the laboratory's measurement process happens to be identical to the Bureau's and is kept under control.

The reason for this is quite clear. Measurement involves much more than a set of calibrated weights, or, more generally, some other calibrated item or instrument. Measurement is first and foremost a process consisting of a set of operations, perhaps using instruments. It is influenced by such factors as operators, temperature, and other environmental factors, and other unknown influences. This process generates a number,

<sup>225</sup> D. D. Davis, J. L. Jespersen, and G. Kamas, "The Use of Television Signals for Time and Frequency Dissemination," *Proceedings of the IEEE* 58 (1970): 931-933.

<sup>226</sup> *Ibid.*, 933.

<sup>227</sup> "Measurement Analysis Program in Mass," *Technical News Bulletin* 54 (1970): 202-203.

much as a manufacturing plant yields a product, with the added complexity that repeated measurements yield slightly different results. To ensure the validity of such a number, the whole process generating it must be kept under control, not simply the weights.

The whole question of the reliability of measurements was addressed by Churchill Eisenhart, who carried through the analogy between a production process and the process of making a measurement, adopting the analytical techniques of industrial quality control.<sup>228</sup> He described and analyzed such concepts as a process which is in a state of "statistical control," or, in lay words, one in which "the amount of scatter in the data from repeated measurements of the same item over a period of time does not change with time and if there are no sudden shifts or drift in the data."<sup>229</sup> Only if a measurement process is in such a state can a meaningful analysis of it be carried out. Eisenhart went on to describe his Postulate of Measurement, originally enunciated by N. Ernest Dorsey as the law of the limiting mean: "The mean of a family of measurements—of a number of measurements for a given quantity carried out by the same apparatus, procedure, and observer—approaches a definite value as the number of measurements is indefinitely increased."<sup>230</sup> This concept is important because the value of the limiting mean can be inferred (within calculable bounds) by statistical means from a limited set of measurements. He then discussed at length the concepts of systematic error, or "bias," or "offset"; of the true value of a quantity; of precision and accuracy; and the uncertainty of a measurement. From this analysis it became clear that not only the weights had to be calibrated to ensure reliable measurements, but also the laboratory itself.

Along with this and previous analyses came Bureau experience. Results on weights that were routinely calibrated over and over again during the course of the Bureau's calibration business, when plotted against time, showed that all the results clustered around one value. This indicated both that the measurement system was in a state of statistical control and that the results tended toward the limiting mean. From this analysis it became clear that, given enough experience, any laboratory can assess and establish its own performance.

How this could be done was developed over a period of years by Paul E. Pontius and Joseph R. Cameron, with the able assistance of Robert C. Raybold.<sup>231</sup> The effort was not simply driven by intellectual curiosity; there were very serious practical considerations.<sup>232</sup> In the early sixties, driven by military and aerospace requirements, the

<sup>228</sup> C. Eisenhart, "Realistic Evaluation of the Precision and Accuracy of Instrument Calibration Systems," *Journal of Research of the National Bureau of Standards* 67C (1963): 161-187.

<sup>229</sup> Brian Belanger, *Measurement Assurance Programs Part I: General Introduction*, Natl. Bur. Stand. (U.S.) Special Publication 676-1; May 1984: 64.

<sup>230</sup> N. Ernest Dorsey quoted in Eisenhart, "Realistic Evaluation": 168.

<sup>231</sup> P. E. Pontius, *Measurement Philosophy of the Pilot Program for Mass Calibration*, Natl. Bur. Stand. (U.S.) Technical Note 288; May 6, 1966; P. E. Pontius and J. M. Cameron, *Realistic Uncertainties and the Mass Measurement Process: An Illustrated Review*, Natl. Bur. Stand. (U.S.) Monograph 103; August 15, 1967; J. M. Cameron, M. C. Croarkin, and R. C. Raybold, *Designs for the Calibration of Standards of Mass*, Natl. Bur. Stand. (U.S.) Technical Note 952; June 1977.

<sup>232</sup> Much of this general background comes from an interview with Robert C. Raybold on October 9, 1992.

mass-calibration facilities of the Bureau were swamped with requests. Most military contracts carried the provision that all measurements should be traceable to the national standards. This required the continuous calibration of the contractor's weights and led to a situation at the Bureau where a dozen or so skilled technicians did nothing but calibrate weights, and another half dozen did nothing but carry out the calculations required by the calibrations. The only way to alleviate this load on the Bureau's facilities was to establish a set of laboratories which were mostly concerned with military and aerospace functions that would take over some of the calibration functions of the Bureau.<sup>233</sup>

Motivated also by a desire to build a mathematical model of the mass calibration process so that effects of variables such as temperature could be quantified, the Bureau set out to build what was essentially a set of satellite standardizing laboratories which it would keep under control, and whose results could be demonstrated to be traceable to the national standards. As a result, a program first called the Pilot Program in Mass, subsequently the Measurement Analysis Program, and finally the Measurement Assurance Program (MAP), was begun. The final definition of a MAP came to be:

A MAP is a quality assurance program for a measurement process that quantifies the total uncertainty of the measurements (both random and systematic components of error) with respect to national or other designated standards and demonstrates that the total uncertainty is sufficiently small to meet the user's requirements.<sup>234</sup>

At first the program was concerned only with calibration laboratories, i.e., commercial calibration laboratories and those laboratories that would carry out calibrations for the operating laboratories in their institution or agency. The Bureau was, in a sense, concerned with replicating itself in a number of lower-level institutions.

To do this, it was necessary to devise a scheme by which the performance of the lower-level laboratories could be assessed. Three things had to be known: (1) whether the laboratory was under statistical control, (2) the standard deviation of its measurements, and (3) the relationship of its results to the national standards.

The key to determining the first and second of these requirements was the "check standard." This was a weight (or a number of them, usually one per decade) owned by the laboratory, that would be calibrated as an unknown during the calibration of other unknown sets of weights. The values of the check standard obtained in these various calibrations could be plotted against time. After enough background information on the check standard was obtained, a new measurement could be expected to fall within certain bounds, expressing essentially the standard deviation of that laboratory's

---

<sup>233</sup> With respect to lessening the calibration load, H. Steffen Peiser pointed out that for many uses of weights, as for example in determination of chemical composition, it is not the relationship of the weights to the standard kilogram that is important, but rather the internal consistency of the weights, and the precision of the weighings. And, as in the Measurement Assurance Program, the system has to be under control. Peiser pointed out that for many of these uses, calibration against the standard kilogram was unnecessary, but high precision was. This viewpoint was not shared by everyone.

<sup>234</sup> Belanger, *Measurement Assurance Programs Part I: General Introduction*: 2.

measurement process. If it did, then the process was under statistical control. If it did not, then either the measurement was an unexplained individual excursion, or a shift in the average-value baseline had occurred. Subsequent measurements would clarify the cause, and sometimes it was necessary to send the check standard to the Bureau for deeper investigation, and possibly for cleaning.

Note that, except for the last part, the Bureau's presence was not necessary in any of the process. All of it could be carried out by the laboratory itself, independently of the Bureau, and it would yield a measure of the laboratory's internal consistency. Where the Bureau did come into the process was in monitoring the process and in determining how the laboratory's results related to the national standard, thereby providing traceability. While there were various ways of assessing this, typically a weight (or a set of weights) referred to as a "transfer standard," with a value unknown to the laboratory, would be calibrated by the Bureau and sent to the laboratory for its calibration. The results and the weight would be returned to the Bureau for re-measurement and further analysis. Upon evaluation of all the results, the Bureau would then issue to the laboratory a report stating the "offset" or systematic error in the laboratory's results compared with the national standards. Combined with a measure of the laboratory's standard deviation, the total uncertainty of the laboratory's measurement process could be determined.<sup>235</sup> Alternatively, an extensively calibrated set of weights could be sent to the laboratory. Since these would become the laboratory's primary standards, special care was to be taken with them. In this manner the Bureau's role in the calibration process was reduced to assessing the performance of the laboratories participating in the Measurement Assurance Program, leaving the bulk of the routine calibration effort to the participating laboratory.

Participation in the MAP was, of course, voluntary, but after inauguration of the program the Bureau only did calibrations under unusual circumstances, instead sending calibration requests to a commercial laboratory participating in a MAP. And the Bureau's participation in a MAP could be deep or shallow, including in some cases personnel training, equipment investigation, suggesting weighing schemes, and carrying out the calculations necessary to determine both standard deviation and systematic error.<sup>236</sup> At the introduction of a new laboratory into a MAP, the Bureau generally worked with it to make sure it was under statistical control.

Mass measurements were the first to utilize the MAP, and by 1970 sixteen laboratories participated in the mass MAP. Other areas soon followed. By 1984 MAPS were available for electrical standard cells at the 1 V level, gage blocks, electrical resistors from 1 ohm to  $10^9$  ohms, capacitance, watt-hour meters, platinum resistance thermometers from  $-183$  °C to  $630$  °C, and laser power and energy. Some of these areas, particularly gage blocks and temperature, involved measurements in actual production, but the

---

<sup>235</sup> *Ibid.*, 3.

<sup>236</sup> Weighing is preferably done by comparing weights of approximately equal size, working with the difference in the weights. This yields a better measurement of the sensitivity. And redundant measurements are necessary in order to arrive at a standard deviation. Some of the schemes and the mathematics involved can be quite intricate. See Cameron, Croarkin, and Raybold, "Designs for the Calibration of Standards of Mass."

MAP philosophy could be adapted to those cases as well. The MAP program markedly reduced the amount of routine calibration the Bureau had to carry out while at the same time improving the Nation's measurement capabilities.

### The Josephson Effect and Maintenance of the Volt

In 1894 an international electrical congress defined the unit of electrical resistance on the basis of the resistance of a column of mercury of specified dimensions, and defined the ampere on the basis of the rate of electrodeposition of silver. Since then, workers in the field of electricity had wanted to do away with these so-called international units and return to the absolute units, which are defined on the basis of mass, length, time, and the equations of physics, rather than on some arbitrary artifact.<sup>237</sup>

But there is a difference between how a unit is defined and realized, and how it is kept, or maintained in the standards laboratory. Thus, in the United States, the representation of the volt was maintained on the basis of the mean electromotive force (emf) of a bank of standard cells, and the ohm was maintained in the form of a bank of wire-wound standard resistors, some of which had at some time been calibrated against the mercury column international standard. Realizations of the absolute ohm were carried out using calculable inductors and capacitors, and the frequency of an alternating current. The realization of the absolute ampere basically involves the measurement of the force between current-carrying coils of very accurate construction and dimensions. Knowledge of the permeability of free space is also required, and this is defined as  $4\pi \times 10^{-7}$  henries/meter. An absolute realization of the volt was not attempted until the coming of the Josephson effect.

By the beginning of World War II absolute realizations of the ampere had become sufficiently accurate to warrant their consideration as a basic standard for electricity.<sup>238</sup> The considerations, including reference to Ohm's law— $I$  (amperes)  $\times R$  (Ohms) =  $V$  (Volts)—led the International Bureau of Weights and Measures (BIPM) in 1946 to recommend a conversion from the "international" electrical to the "absolute" units, and on January 1, 1948, the changes were adopted. The results showed that there were significant differences between the mean international units and the absolute units as follows:

1 mean international ohm = 1.00049 absolute ohms

1 mean international volt = 1.00034 absolute volts

<sup>237</sup> F. B. Silsbee, *Establishment and Maintenance of the Electrical Units*, Natl. Bur. Stand. (U.S.) Circular 475; June 30, 1949; *Announcement of Changes in Electrical and Photometric Units*, Natl. Bur. Stand. (U.S.) Circular 459; May 1947; "Reference Base of the Volt to be Changed," *Technical News Bulletin* 52 (1968): 204-206.

<sup>238</sup> The "international" units were originally designed to be as close to the absolute units as possible at the time of their definition. It is also important to recognize the "mean international" units, which were the average of the units maintained by France, Germany, Great Britain, Japan, the Soviet Union, and the United States.



For the United States the results were:

1 international ohm (U.S.) = 1.000495 absolute ohms

1 international volt (U.S.) = 1.00033 absolute volts.

By the late sixties, the determination of the absolute ampere had progressed to the point where a re-definition of the "maintained" volt was recommended by the International Committee for Weights and Measures (CIPM) to the BIPM. Under this re-definition the volt maintained by the BIPM was decreased by 11 parts per million on January 1, 1969. In view of its relationship to the BIPM volt, the Bureau-maintained legal U.S. volt, as realized by the group of standard cells, was increased by 8.4 parts per million, and beginning in 1969 all Bureau calibrations were done on this new basis. The new basis was not occasioned by drift in the standard cells used to maintain the volt, but by new, more accurate realizations of the absolute ampere. It was not a large change for practical work, but a necessary one for precision measurements.<sup>239</sup>

The Bureau had not allowed the volt to drift willy-nilly without checking. In fact, during the six years from 1961 to 1967, the volt was under continuous surveillance. The monitoring was accomplished via the precession frequency of the proton (in water) in the field of a solenoid magnet in which the current was defined in terms of the NBS volt and the ohm. These measurements showed that the ratio of the volt to the ohm had not changed as much as 1 part per million over the six years.<sup>240</sup> Since other experiments showed that the ohm had changed less than this, it was concluded that the volt had also remained constant to better than 1 part per million. But this surveillance was difficult, complex, and expensive. The measurement of the dimensions of the solenoid limited the accuracy of the magnetic field to 1 part per million, and was furthermore affected by the magnetic environment. As a result, none of the other national laboratories had carried on such monitoring.<sup>241</sup> But triennial comparisons between the standard cells of the national laboratories with those maintained by the BIPM showed differences of the order of a few parts per million, some positive and some negative. It was hard to tell what was drifting.

In 1962, Brian D. Josephson at Cambridge University predicted the effect that would bear his name. He showed that if two superconductors were "weakly coupled," as for example two crossed superconducting film strips separated by a nanometer thick film of oxide, then a current could tunnel through the barrier. Further, impressing a voltage across the superconducting sandwich (called a "junction"), was predicted to produce radiation of a specified frequency. The ratio of the frequency to the voltage

---

<sup>239</sup> "1968 Actions—International Committee of Weights and Measures," *Technical News Bulletin* 53 (1969): 12-13.

<sup>240</sup> Annual Report for 1967: 22.

<sup>241</sup> B. N. Taylor, W. H. Parker, D. N. Langenberg, and A. Denenstein, "On the Use of the AC Josephson Effect to Maintain Standards of Electromotive Force," *Metrologia* 3 (1967): 89-98.

was equal to twice the ratio of the electronic charge to Planck's constant, or  $2e/h$ —a fundamental constant now known as the Josephson constant. The effect was predicted to be independent of the superconductor, the nature of the "weak coupling," the magnetic environment, and other factors. The relationship was exact.

Even more important for metrological purposes was the inverse of this phenomenon. In this case, impressing a microwave-frequency electromagnetic wave across the junction caused its current-voltage characteristic curve to show a series of steps. Increasing the current through the junction produced steps in which the voltage remained sensibly constant until the current reached a critical value at which point the voltage suddenly increased to a new level, i.e., a series of constant-voltage steps was produced. If  $n$  is the step number (an integer),  $V_n$  the voltage of the  $n$ th step, and  $f$  the frequency, then the ratio  $nf/V_n$  was predicted to be exactly  $2e/h$ , which, for orientation purposes, is about 484 MHz/ $\mu$ V.

This relationship is a metrologist's dream. The integer  $n$  is determined simply by counting, e.g., from the characteristic curve of the junction displayed on an X-Y recorder, and the frequency can be determined so accurately that any uncertainty in it is negligible. As a result, the voltage can be determined in absolute units with an uncertainty determined solely by that in the fundamental constant  $2e/h$ . It was another case in which there arose the possibility of a fundamental constant replacing an artifact as a basic standard.

As pointed out by Barry N. Taylor, the effect has three uses:<sup>242</sup>

1. To check on the constancy of reference standards of emf over a long period of time.
2. To infer the relationship between reference standards for voltage of different national laboratories.
3. To calibrate reference standards for emf in absolute units.

Note that only the last one requires an accurate knowledge of  $2e/h$ ; the first two require only that it be a constant.

Since superconducting junctions are relatively cheap and easy to produce, are easily portable, and all the other needed pieces of equipment are readily available (except perhaps one, as we shall see) in any reasonably equipped national laboratory, the effect is particularly useful for the comparison of the voltage standards of various laboratories, and for the monitoring of one nation's standard-cell maintained volt.

The one piece of apparatus that was not so readily available was the one needed to compare the voltage across the junction with the voltage of the standard cell. The maximum voltage of a single junction is of the order of a few millivolts, while that of a standard cell is about a volt. To relate one voltage to the other with a high degree of

---

<sup>242</sup> Ibid., 90. At the time this work was done Taylor was at the RCA Laboratories in Princeton. His coauthors were at the University of Pennsylvania. Taylor joined the staff of the Electricity Division of the Bureau in June 1970.

accuracy required special equipment. To solve this problem initially, the Bureau's resident expert on such measurement matters, Forrest K. Harris, and two associates, Howland A. Fowler and P. Thomas Olsen, developed a special potentiometer which could compare a signal of 2 millivolts to 10 millivolts against the U.S. "legal" volt with an accuracy and precision of a few parts in  $10^7$ .<sup>243</sup>

Using this instrument and one with an even smaller uncertainty, the Bureau began experiments using the Josephson effect to monitor any changes in the standard cells maintaining the U.S. legal volt.<sup>244</sup> Assuming that  $2e/h$  was a constant, it was found that the mean emf of the group of standard cells decreased linearly by about 4 parts in  $10^7$  over the one-year period, beginning in July 1971. To compensate for this drift, the Bureau adopted the value of  $483\,593.420\text{ GHz}/V_{\text{NBS}}$  for  $2e/h$ , which was consistent with the existing U.S. volt, and used this value to assign a mean emf periodically to the bank of electrolytic cells. This assignment became the definition of the new as-maintained unit of emf for the Nation, and it could be maintained with a precision of about 2 parts in  $10^8$ .<sup>245</sup> It was a major step in the shift to an absolute volt realized by the Josephson effect.

To take a further step, the value of  $2e/h$  had to be defined internationally, and a more accurate comparison of the volt as maintained by the various national laboratories had to be carried out. In a comparison made under the auspices of the BIPM, the Bureau, with the support of the U.S. Air Force, transported standards cells in temperature-controlled containers and compared them with the cells used for maintaining the volt by the BIPM, the United Kingdom, Canada, Australia, and Germany.<sup>246</sup> The "main purpose was to provide a sound basis for intercomparing values of  $2e/h$  obtained by the various laboratories via the Josephson effect." By the use of temperature-controlled enclosures and techniques used in the Measurement Assurance Program, it was found that, converted to a common unit, most of the values of  $2e/h$  agreed with one another to 1 to 2 parts in  $10^7$ . This was another major step toward the use of the Josephson effect for the realization of the absolute volt. The quantum Hall effect would subsequently provide a means of realizing the absolute ohm directly from a physical phenomenon. With this development, and the development of Josephson junction arrays, absolute volt and ohm standards would become commonplace.

---

<sup>243</sup> F. K. Harris, H. A. Fowler, and P. T. Olsen, "Accurate Hamon-Pair Potentiometer for Josephson Frequency-to-Voltage Measurements," *Metrologia* 6 (1970): 134-142; Annual Report for 1970: 43-44.

<sup>244</sup> T. F. Finnegan and A. Denenstein, "High Accuracy Potentiometers for Use With Ten Millivolt Josephson Devices. I. Double Series-Parallel Exchange Comparator," *Review of Scientific Instruments* 44 (1973): 944-953.

<sup>245</sup> B. F. Field, T. F. Finnegan, and J. Toots, "Volt Maintenance at NBS via  $2e/h$ : A New Definition of the NBS Volt," *Metrologia* 9 (1973): 155-166; "NBS to Maintain U.S. Legal Volt Using  $2e/h$  Via the AC Josephson Effect," *Technical News Bulletin* 56 (1972): 159-160.

<sup>246</sup> W. G. Eicke, Jr., and B. N. Taylor, "Summary of International Comparisons of As-Maintained Units of Voltage and Values of  $2e/h$ ," *IEEE Transactions on Instrumentation and Measurement* IM-21, (1972): 316-319.

## Temperature

The International Practical Temperature Scale (IPTS) is the practical scale in general use.<sup>247</sup> It is based on certain reference temperatures or "fixed points" whose assigned temperatures are as close as possible to the true, thermodynamic values, with interpolation formulae between the fixed points. The Consultative Committee on Thermometry (CCT), in its capacity of technical advisor to the CIPM, revises the IPTS periodically—about every 20 years. The CCT meets at the BIPM at intervals of 2 or 3 years, evaluates the recent advances in thermometric metrology and recommends new or revised R&D at the world's national (or other participating) laboratories. Each delegate is an expert representing a national standards laboratory or is otherwise coopted by the CCT. The 20-year effort of research, evaluation and scale formulation culminates in a consensus recommendation to the CIPM.

In the IBS, responsibility for IPTS activities fell to the Heat Division and its relevant sections: Temperature, Radiation Thermometry (later Optical Radiation) and Cryogenic Physics. Director Astin would appoint the division chief as the NBS delegate to a CCT meeting and, on occasion, one (or even two) colleagues would go along. The division had traditionally made a major contribution to IPTS development, but so extensive was the program during this particular interval that BIPM Director Jean C. Terrien took the unprecedented step of holding the 1967 meeting of the CCT in Washington, so that the committee as a whole could examine the NBS work at first hand, prior to finalizing the formulation of IPTS-68.<sup>248</sup>

In a somewhat more theoretical vein, Robert A. Kamper and his associates in the Cryogenics Division developed a scheme for the measurement of very low temperatures.<sup>249</sup> Based on the Josephson effect, the principle of the measurement was that any noise in the voltage applied to a Josephson junction will cause a random frequency modulation of the oscillation of the junction. If the noise is Johnson noise, thermally generated in a shunt resistor through which a current is passed to bias the junction, the resistor noise voltage is easily calculated and is directly proportional to the product of the absolute temperature and the resistance. The noise voltage causes a broadening of the Josephson oscillation, and the authors showed that the resulting line width is also proportional to the absolute temperature. Thus, if the size of the resistor is known, the temperature is easily calculated since the other quantities appearing in the equations are well-known fundamental constants.

Using a dilution refrigerator, temperatures of about 0.075 K were easily measured. Later the lower limit was extended to 0.006 K by Robert Soulen of the Cryogenic Physics Section, and it was estimated that it could be extended to temperatures somewhat below 1 mK.

<sup>247</sup> T. J. Quinn, *Temperature* (New York: Academic Press, 1983); Chapter 2.

<sup>248</sup> C. R. Barber in "The International Practical Temperature Scale of 1968," *Metrologia* 5 (1969): 35-44.

<sup>249</sup> A. H. Silver, J. E. Zimmerman, and R. A. Kamper, "Contribution of Thermal Noise to the Line Width of Josephson Radiation From Superconducting Point Contact," *Applied Physics Letters* 11 (1967): 209-211; R. A. Kamper and J. E. Zimmerman, "Noise Thermometry With the Josephson Effect," *Journal of Applied Physics* 43 (1971): 132-136; R. A. Kamper, J. D. Siegwarth, R. Radebaugh, and J. E. Zimmerman, "Observation of Noise Temperature in the Millikelvin Range," *Proceedings of the IEEE* 59 (1971): 1368-1369; "NBS Advances New Concept in Low-Temperature Measurement," *Technical News Bulletin* 52 (1968): 71-72.



Lewis O. Mullen (left) monitored temperature during the fabrication of a thin-film Josephson junction while Robert A. Kamper (center) and Donald B. Sullivan observed. A study by these NBS scientists led to the first observation of Josephson oscillation in the radiofrequency range using thin films.

### **Radio Standards**

The development of radio-frequency standards for electrical measurements continued. In many cases the eventual utility of new measurement capabilities was in calibrations—for new quantities or for older quantities in new ranges of frequency, power, voltage, etc. A short list of the new calibrations offered during the period gives a feeling for the developments.

- The frequency range of the radio-frequency pulse power reference standard was increased to include frequencies for the range 300 MHz to 500 MHz, augmenting the 900 MHz to 1200 MHz range in which calibrations had been offered. The power range involved was 0.2 mW to 2 kW with an uncertainty of 3 percent. (1965)
- A calibration service for noise in the frequency range 12.4 GHz to 18.0 GHz was offered. (1965)
- A calibration service for the measurement of the reflection coefficient magnitude in a waveguide at 3.95 GHz to 5.85 GHz was developed. Interlaboratory wave guide standards with reflection coefficient magnitudes from 0.024 to 0.2 could be measured and compared. (1966)
- A pair of precision co-axial thermal noise generators were developed as primary standards for noise in the high frequency ranges. At the time both operated at 30 MHz or 60 MHz, but could be adjusted to operate at other frequencies and over a wide range of noise temperatures. (1969)
- Perhaps the instrument that caused the most excitement in the period was the Bolovac—for bolometric voltage and current—standard head. Built around the bolometric properties of a thin film in the form of a split disk, the



Myron C. Selby held the bolometric voltage and current (Bolovac) standard which he invented in 1967 to provide known voltages and currents at high and microwave frequencies to 20 000 MHz.

instrument could be used to measure voltage, current and power from 1 MHz to 20 GHz. The range of voltage and current were 0.05 V to 10 V and 5 mA to 10 A respectively. The secret of its success was that the resistance of the film was the same at all frequencies as at dc and had a frequency-independent temperature coefficient. Hence, upon simple calibration with dc, the Bolovac could be used at all frequencies, and it was easier to use and much more accurate than traditional methods. (1968)

- A calibration service for pulse rise time was begun during the period. It used a commercially available oscilloscope as the principal element of the system. The oscilloscope was evaluated in the frequency domain, and from this study it was possible to calculate its time-domain response. The service was primarily designed for tunnel diode step generators and two-port passive devices. (1970)

### Toward a New Era in Radiometry

So far in this history we have discussed the work of the Bureau in five of the six basic measurement standards: mass, length, time, temperature, and the ampere. We have not discussed standards for radiometry and its sibling photometry, that are embodied in the SI unit, the candela. Because this branch of physics is somewhat esoteric, we now provide a short historical note on its development. It is an opportune time to do this, for, as we shall see, the sixties and early seventies were times in which the Bureau's activities in the field increased.

Radiometry can be defined as the detection and measurement of the energy flux carried by electromagnetic radiation, which is a physical measurement. By contrast, photometry is the study of light and its brightness as perceived by humans. As such, it is not a physical measurement, but has been called "psychophysical." Photometry is, nevertheless, very important, and the whole subject arose from studies devoted to it. Here we discuss the more general but conceptually simpler subject of radiometry.

The scientific development of radiometry began with the study of the visible effects of radiation, or photometry.<sup>250</sup> Using liquid-in-glass thermometers to assess the relative energy<sup>251</sup> content of different colors of light in the continuous solar spectrum, Friedrich W. Herschel in 1800 discovered infrared radiation and, a year later, Johann W. Ritter, studying the chemical effect of light on silver nitrate solutions, discovered ultraviolet radiation. In a sense, this was the beginning of radiometry.

The nineteenth century was a period of considerable development for radiometry, and it became one of the main thrusts of physics during that period. Aside from the pull of science, the development was spurred substantially by the development of gas

---

<sup>250</sup> Jon Geist, "Trends in the Development of Radiometry," *Optical Engineering* 15 (1976): 537-540.

<sup>251</sup> These early studies were carried out before the equivalence of heat and energy had been demonstrated. Thus the studies at the time were concerned with the "heat content" of radiation. We shall continue to use the modern terminology.

lighting and subsequently electric lights, and a quest for better photometric standards than the standard candles which were used earlier. Perley G. Nutting in his book *Outlines of Applied Optics* writes, "The service of radiometry to other branches of applied optics lies largely in the study of such reference standards and the determination of the constants of the radiation formulas."<sup>252</sup>

The quest for standards took two paths: the study of radiation sources and the study of radiation detectors. In the former direction, the concept of a blackbody was developed in mid-century, along with the realization that, at least in principle, such a body operated at a constant temperature could be used as a standard source of radiation. Of course, the crowning achievement of the work in this direction was the discovery by Max Planck in 1900 of the radiation law that bears his name, thereby setting into motion work that would lead to quantum mechanics and a revolution in physics. As is now well known, the law gives the radiated energy flux from a blackbody per unit area as a function of wavelength and temperature, and an integration over wavelength gives the total flux radiated per unit area as a constant multiplied by  $T^4$ , a relation that is embodied in the Stefan-Boltzmann radiation law. Planck's equation contains only one adjustable parameter, the constant  $h$  that bears his name, but for the purposes of radiometry, there are considered to be two constants,  $c_1$  and  $c_2$ , which are combinations of  $h$  with the speed of light and Boltzmann's constant  $k$ . Thus, if these constants were well enough known, if the thermodynamic temperature of the blackbody were well known and could be controlled with sufficient accuracy, and if one could construct a device approximately satisfying the definition of a blackbody (a "laboratory blackbody"), one would have all the requisites for a primary basic measurement standard for both photometric and radiometric purposes. The principal quantities for which the Planck blackbody standard could in principle be used are spectral radiance (watts/m<sup>2</sup> · solid angle · wavelength interval), radiance (watts/m<sup>2</sup> · solid angle) and radiant exitance, also called irradiance, (watts/m<sup>2</sup>). Unfortunately, it was not until much later that the constants in the Planck radiation law were well enough known to permit the calculation of these quantities with less than 1 percent uncertainty. Nevertheless, as we shall see, the laboratory blackbody became the primary standard of photometry and radiometry.

The other direction that radiation science took was that of detector development. This proved to be a fruitful area. Sensitive thermocouples and thermopiles for the measurement of radiation intensity were developed, and later the yet more sensitive bolometer. But the most important development in detector radiometry was the development and construction by Anders Jonas Ångström in 1893 of the first standard detector, an electrically calibrated bolometer. In this instrument, the steady-state temperature rise produced at the detector by a radiation source was first measured. The detector was then heated by an electric current to the same steady-state temperature. Assuming that the heat losses were the same, the power in the two cases would also be the same, and since the dissipated electrical power is very easy to measure with high accuracy, the radiant power is also measured. Such an instrument would in due course be called an "absolute radiometer" but, as we shall see, the quantitative determination of the uncertainties in its use is not a trivial task. Nevertheless, research in this new technique flourished in the early years of the century.

---

<sup>252</sup> Perley G. Nutting, *Outlines of Applied Optics* (Philadelphia: Blakiston's, 1912): 201.



The Bureau, born in the same year that Planck published his paper on his radiation law, became deeply involved in photometric standards from the beginning. It adopted the British candle as the unit of luminous intensity (visible flux per unit solid angle) but chose to maintain it by carbon-filament incandescent lamps calibrated by the Physikalisch-Technische Reichsanstalt (PTR) against their primary standard Hefner (amyl acetate) lamp, and corrected for the known relationship of that unit to the British unit.<sup>253</sup>

Rather more important for radiometry was the work of William W. Coblentz, who followed on the work of Ångström on electrically compensated detectors, but using a very sensitive bismuth-silver thermopile. Coblentz used the instrument to measure the radiation from a Hefner lamp, a standard sperm candle, and carbon-filament incandescent lamps. He found the last to be the best as secondary standards, writing "such a lamp has every desideratum of a standard of radiation, when calibrated against a blackbody as the primary standard of radiation."<sup>254</sup> In a later paper he investigated the bismuth-silver thermopile extensively, using it in thirteen different receivers. He obtained an inaccuracy of the order of 1 percent, and came to the conclusion that "one can consider the present device a primary instrument for evaluating radiant energy in absolute measure."<sup>255</sup>

Of course, to complete the chain he had to know the constants in the Planck and Stefan-Boltzmann laws, so he set out on perhaps his best known work: the measurement of the Stefan-Boltzmann constant. For this study he used an electrically compensated bolometer to measure the radiant flux from a blackbody. The value he obtained, using 11 differently prepared receivers in 304 measurements, was  $5.72 \times 10^{-12}$  watt  $\text{cm}^{-2} \text{deg}^{-4}$ . The accuracy was about 1 percent.<sup>256</sup> Due to an unfortunate coincidence, this figure agreed to within 0.1% with the value of the Stefan-Boltzmann constant as calculated from what was soon discovered to be an erroneous set of values for the fundamental constants. It would not be until 1970 that the error in the measured quantity would be reduced to less than 1 percent.

In the next fifty years, radiometry and photometry made some advances. The laboratory blackbody became recognized as the primary standard of optical radiation, many new types of sources were developed, and new detectors—particularly photoelectric—were developed. But as a branch of physics, radiometry lagged and assumed more of a supportive role in such emerging fields as atmospheric physics, in the development of infrared and ultraviolet spectrophotometers, and in military and space applications of radiation.

<sup>253</sup> Two excellent papers illustrate the Bureau's photometric work at the time. They are: E. P. Hyde, "A Comparison of the Unit of Luminous Intensity of the United States With Those of Germany, England, and France," *Bulletin of the Bureau of Standards* 3 (1907): 65-80; E. B. Rosa and G. W. Middlekauff, "Carbon Filament Lamps as Photometric Standards," *Proceedings of the American Institute of Electrical Engineers* 29 (1910): 1191-1205.

<sup>254</sup> W. W. Coblentz, "Measurements on Standards of Radiation in Absolute Value," *Bulletin of the Bureau of Standards* 11 (1915): 92.

<sup>255</sup> W. W. Coblentz and W. B. Emerson, "Studies of Instruments for Measuring Radiant Energy in Absolute Value: An Absolute Thermopile," *Bulletin of the Bureau of Standards* 12 (1915-1916): 550.

<sup>256</sup> W. W. Coblentz, "Present Status of the Determination of the Constant of Total Radiation From a Black Body," *Bulletin of the Bureau of Standards* 12 (1915-1916): 577.

Beginning in 1960 things began to change. In the area of sources, the Bureau introduced a tungsten-strip lamp as a new standard of spectral radiance for the wavelength range from the near ultraviolet to the infrared.<sup>257</sup> The announcing publication also described the construction and use of a blackbody for calibration of the lamp. Three years later another lamp was introduced, covering the same wavelength range but with higher power and radiant efficiency, to be used as a new standard for spectral irradiance.<sup>258</sup> This was calibrated by the tungsten-strip lamp just described, so that it too was indirectly calibrated against a blackbody. Finally, with this kind of source, in 1966 the Bureau issued another tungsten-filament lamp to be used as a standard of total irradiance.<sup>259</sup> The standard of total irradiance had been a 50 W carbon-filament lamp, used since Coblentz calibrated it against a laboratory blackbody in 1913. Now the need for higher accuracy and wider irradiance range required developing new standards, and tungsten-filament lamps of 100 W, 500 W, and 1000 W were chosen for the new standards. Thus, with the issuance of these three new types of lamps, new radiometric standards were made available. In addition to these new lamp standards, the reader will recall the synchrotron which is an almost ideal source of radiation in the vacuum ultraviolet. In addition to this technique were developments in the hydrogen arc which permitted the introduction of the deuterium arc as a transfer standard of spectral radiance and irradiance, which extended the range of calibrations to the vacuum ultraviolet.

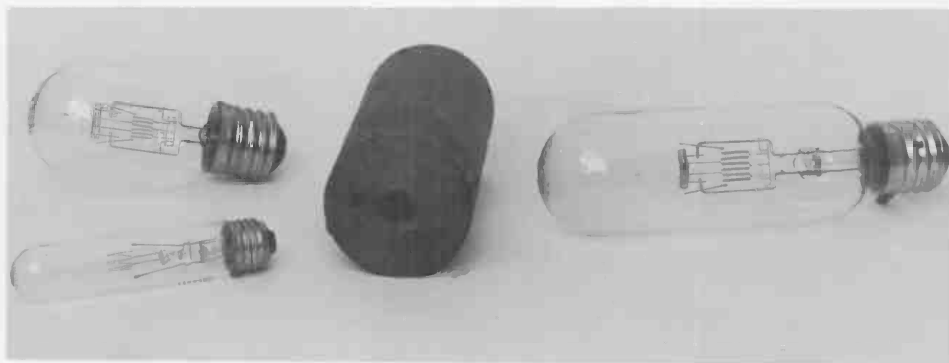

Tungsten-filament lamp standards adopted by NBS in 1966. These standards increased the accuracy and range of irradiance measurements beyond those possible with the previously used carbon-filament lamps. The blackbody (center) was used to calibrate the lamps.

<sup>257</sup> R. Stair, R. G. Johnston, and E. W. Halbach, "Standard of Spectral Radiance for the Region of 0.25 to 2.6 Microns," *Journal of Research of the National Bureau of Standards* 64A (1960): 291-296.

<sup>258</sup> R. Stair, W. E. Schneider, and J. K. Jackson, "A New Standard of Spectral Irradiance," *Applied Optics* 2 (1963): 1151-1154.

<sup>259</sup> R. Stair, W. E. Schneider, and W. B. Fussell, "The New Tungsten Filament Lamp Standards of Total Irradiance," *Applied Optics* 6 (1967): 101-105.

Driven by the needs of the space program and laser calibration was the field of detector-based radiometry, and this led to the development of electrically calibrated radiometers for "traditional photometric and radiometric applications. . . solar radiation . . . and laser applications." In addition, a "long standing discrepancy. . . between the measured and calculated values of the Stefan-Boltzmann constant has been resolved,"<sup>260</sup> so that experiment and theory now agreed to within approximately 0.1 percent.<sup>261</sup> From the Bureau came work in two directions. First there was the work of Jon Geist which we will summarize here.<sup>262</sup> Second, there was the work of a group in the Electromagnetics Division in Boulder using a pyroelectric detector, to measure the power of laser beams.<sup>263</sup>

The work of Geist was part of a larger IBS program initiated in 1968 on optical radiation measurements. In Technical Note 594-1, Geist describes in detail the design and construction of an electrically calibrated thermopile-type radiometer, and an exhaustive analysis of the magnitudes of the various errors that could enter into the design. As we have seen, the radiometric scales obtained with such an instrument have traditionally been called "absolute" although, as pointed out by Geist, they are no more absolute than scales obtained by calibration against a blackbody, either directly or indirectly. But the latter types of measurements depend on the knowledge of the constants in the Planck and Stefan-Boltzmann radiation laws, upon the knowledge of the thermodynamic temperature (no small task at 1000 K or higher), and the experimental realization of a blackbody. The thermopile-type of measurements in principle require only the measurement of temperature rise and electric power, both of which are much simpler and far more accurate measurements.

Numerous errors can, of course, creep into the construction of an electrically calibrated instrument. To determine these errors and their effects, Geist identified two philosophies in the design and construction of measuring instruments. The first philosophy attempts to minimize all errors, while the second does not necessarily minimize the magnitude of the errors, but rather minimizes the uncertainty with which they can be measured, and then corrects for them. Geist argues that an instrument built to the second philosophy is more useful for the realization of measurement scales than one built on the first philosophy, which is more suited for the transfer of scales. As a result, the second philosophy guided the effort. In short, Geist set out to build a primary-standard radiometer.

---

<sup>260</sup> Geist, "Trends in the Development of Radiometry": 538.

<sup>261</sup> W. R. Blevin and W. J. Brown, "A Precise Measurement of the Stefan-Boltzmann Constant," *Metrologia* 7 (1971): 15-29; J. M. Kendall, Sr., and C. M. Berdahl, "Two Blackbody Radiometers of High Accuracy," *Applied Optics* 9 (1970): 1082-1091.

<sup>262</sup> Jon Geist, *Optical Radiation Measurements: Fundamental Principles of Absolute Radiometry and the Philosophy of This NBS Program (1968 to 1971)*, Natl. Bur. Stand. (U.S.) Technical Note 594-1; June 1972.

<sup>263</sup> C. A. Hamilton, G. W. Day, and R. J. Phelan, Jr., *An Electrically Calibrated Pyroelectric Radiometer System*, Natl. Bur. Stand. (U.S.) Technical Note 678; March 1976.

We can only give a sketchy account of the instrument, its analysis, and its use. Basically it consisted of a receiver disk upon whose upper side the radiation flux to be measured fell. This side was coated with some type of high-radiation-absorptance coating, i.e., some type of blackening. Attached to the disk was a thermopile of circular construction consisting of copper-constantan thermocouples in a radial arrangement. Also attached to the disk was a resistance heater to measure the power necessary to raise the receiver disk to the same temperature as did the radiation. To provide a stable thermal environment, the entire assembly was placed in an isothermal chamber with an aperture whose dimensions were accurately known, and through which the radiation fell on the receiver surface. The whole assembly, including the chamber, measured  $12.5 \text{ cm} \times 8.3 \text{ cm} \times 5 \text{ cm}$ .

There are a set of "easy" errors, and a set of "hard" errors in the instrument. The measurements with "easy" errors were:

- The voltage across the thermopile
- The voltage across the heater
- The current in the heater
- The area of the aperture.

The measurements or conditions with "hard" errors were:

- Not all of the incident radiation is absorbed by the high-absorbtion coating
- Not all of the heater power is absorbed by the receiver
- The power generated in the heater leads modifies the temperature distribution in the radiometer
- The incident flux also modifies the temperature distribution in the chamber
- The temperature distribution in the receiver and high-absorptance coating is different when receiving radiation from that when being electrically heated.

All the easy errors involve only well-known customary measurements that are made routinely and accurately in any well-equipped laboratory. The "hard" errors are quite different. To determine their magnitude required first an exhaustive mathematical analysis of the physical processes involved and their sensitivity to errors. And the determination of their magnitudes and the uncertainties in the magnitudes required painstaking experimentation.

One of the radiometers, ECR-10 (for Electrically Compensated Receiver), was used as a pyrheliometer (i.e., for the measurement of solar radiation) in the Third International Pyrheliometer Comparison held at Davos, Switzerland, in September 1970. Interestingly, it was compared against Ångström 210, built on the Ångström design.<sup>264</sup> The results showed that the ratio of results with Ångström 210 was 1.0180 with a limit of error of  $\pm 0.0063$ , or 0.63 percent. While this level of uncertainty was somewhat disappointing, it was felt that with some serious effort the error limits could be lowered to 0.1 percent.

<sup>264</sup> As a footnote of historical interest, Jon Geist informed us that one of the pyrheliometers used in the comparisons was actually built by Ångström.

## Standard Reference Materials (SRMs)

Production and sales of SRMs continued during the period. By 1968, 669 different kinds were available and the total sales numbered approximately 43 000 units. Indeed, there were requests for far more kinds of SRMs than could be developed and produced, and the newly formed Office of Standard Reference Materials had to set priorities on which of the requested materials were chosen for preparation. A few of the newer materials, culled from the Annual Reports, were:

- Lead isotopic composition standards were designed for the calibration of mass spectrometers used in the determination of the isotopic composition of lead in rocks, meteorites, and ores to determine their ages. Along the same line were natural-ratio isotopic composition standards for chlorine, bromine, copper, silver, and chromium. These were produced as part of a program on atomic weights. (1968)
- A second viscosity-of-glass standard was made available for use in the calibration of the viscosity-measuring instruments used in glass production. (1965)

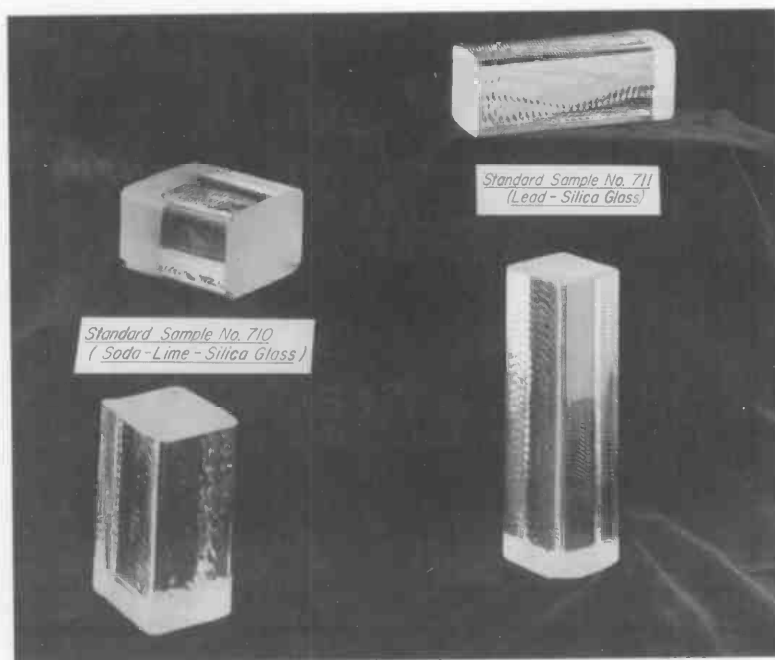

NBS glass-viscosity standards are used to calibrate glass viscometers, particularly those utilized in high-speed mass production processes. Viscosity must be held to close tolerances to obtain glass products of uniform thickness, shape, and strength.

- Glass beads for neutron flux measurements were prepared from three different glasses enriched in boron-10, along with one of several activators that is potentially radioactive via neutron absorption. These materials were developed as a straightforward way to determine slow-neutron flux. Dysprosium glass and indium glass materials are alternate absolute standards, while cobalt glass is a secondary, or transfer, standard. (1965)
- A freezing-point SRM meeting all of the requirements of a fixed point on the International Practical Temperature Scale was prepared from zinc with a purity of 99.9999 percent. The zinc point replaced the sulfur point on the IPTS, and important step in the maintenance of the temperature scale. (1967)

Perhaps the most exciting development was the production of standards for use in clinical laboratories that would lead the Bureau into the whole new field of clinical standards. The clinical SRM program began by using only its own funds, but was soon given generous support from the National Institute for General Medical Sciences of the National Institutes of Health.

In the early sixties, clinical tests—mostly carried out on automated equipment—were a large and growing activity. It was estimated that 750 million to 1 billion tests were run annually, and the rate was increasing at 10 percent to 15 percent per year.<sup>265</sup> But all was not well with these measurements. In 1963, the College of American Pathologists (CAP) had conducted a national survey of over 1000 clinical laboratories on the analysis of cholesterol. The laboratories were sent two cholesterol solutions for analysis, and the results were disturbing. They showed variations ranging from 25 percent to 50 percent,<sup>266</sup> caused largely by the “systemic bias not only in a given method, but also between methods.”<sup>267</sup> Standards were available for instrument calibration, but the CAP concluded that they varied in purity and were not suitable.<sup>268</sup>

As result of this survey, the CAP and the American Association of Clinical Chemistry (AACC), following a meeting of many associations interested in high-purity cholesterol,<sup>269</sup> approached the Bureau about producing a standard sample of cholesterol of certified purity. It was expected that the program would extend beyond cholesterol. It was a classic case of the need for a standard sample to bring a measurement system under control.

<sup>265</sup> “Clinical and Biomedical Standards,” *Technical News Bulletin* 53 (1969): 92-94.

<sup>266</sup> Annual Report for 1968: 30.

<sup>267</sup> More exactly, in 1949 the precision of laboratory measurements was  $\pm 23\%$ . By 1969, two years after the introduction of the Bureau’s cholesterol SRM, the precision was  $\pm 18.5\%$ . By 1986, after the introduction in 1981 of a serum cholesterol SRM, the precision was  $\pm 6\%$ . (Figures provided by Harry S. Hertz.)

<sup>268</sup> “Clinical and Biomedical Standards”: 92.

<sup>269</sup> D. S. Young and T. W. Mears, “Measurement and Standard Reference Materials in Clinical Chemistry,” *Clinical Chemistry* 14 (1968): 929-943.

By December 1967, the cholesterol SRM was completed and sales began. It consisted of a material obtained from Distillation Products Industries of Rochester, New York, where the natural product was purified according to the method of Louis F. Fieser,<sup>270</sup> as set forth in the joint AACC and CAP specifications. The purity determination, carried out under the direction of Robert Schaffer and by far the hardest part of the project, was done by gas chromatography; thin-layer chromatography; and mass, infrared, and nuclear-magnetic-resonance spectrometry.<sup>271</sup> The SRM was certified as being  $99.4 \pm 0.3$  percent pure. Later, other methods were used to assay the samples, but it was still a long job.<sup>272</sup>

Cholesterol was only the first of a long line of clinical SRMs. By 1969 three other materials had joined it: urea, uric acid, and creatinine. By 1979 there were thirty, including organics, metal organics, and inorganics. The Bureau had become the national center for standards for clinical laboratories.

\* \* \*

In 1970, the Bureau announced the availability of a new class of materials. Named Research Materials (RMs), they were designed to provide research workers in materials science with materials of very high uniformity so that researchers in different laboratories could all be assured of working on material of the same composition. What made RMs different from SRMs was that the Bureau did not certify any property for the former, as it did for the latter. Unlike SRMs, Research Materials were not designed to calibrate measuring instruments, but rather to make the results of research more meaningful for having been achieved on a constant, uniform material, even though such quantities as impurity level and perfection were not necessarily well known. While the Bureau did not provide a certificate with an RM, it did provide a "Report of Investigation," generally a scientific paper, with the accuracy of its results the sole responsibility of the author.

The first RM offered was ultra-high purity aluminum. Offered in both polycrystalline rods (25.4 mm  $\times$  4.17 mm) and single-crystal cubes (approximately 1 cm on a side), the material had an extremely high resistivity ratio (resistance at 273 K divided by the resistance at 4.2 K), denoting extremely high purity. The impurity level was estimated to be 0.25 parts per million molar.

Never big sellers, by 1979, the Bureau offered eight RMs, including a homogeneous river sediment for "testing radiochemical procedures for the assay of radioactivity in sediments or soils," and albacore tuna for use in determining elements present in trace concentration.<sup>273</sup>

---

<sup>270</sup> L. F. Fieser, "Cholesterol and Companions VII. Steroid Dibromides," *Journal of the American Chemical Society* 75 (1953): 5421-5422.

<sup>271</sup> Young and Mears, "Measurement and Standard Reference Materials in Clinical Chemistry": 939.

<sup>272</sup> R. W. Seward and R. Mavrodineanu, *Standard Reference Materials: Summary of the Clinical Laboratory Standards Issued by the National Bureau of Standards*, Natl. Bur. Stand. (U.S.) Special Publication 260-71; November 1981.

<sup>273</sup> *NBS Standard Reference Materials Catalog, 1979-80 Edition*, Natl. Bur. Stand. (U.S.) Special Publication 260; 1979: 77.

## Standard Reference Data

The Bureau, at the behest of the Federal Council for Science and Technology (FCST) in 1963, and in 1968 under the Standard Reference Data Act, became responsible for the operation of the National Standard Reference Data System (NSRDS). The program never became as large as optimistically projected at its inception.<sup>274</sup> Thus, in 1966, the Bureau projected the program to grow from \$1.2 million in 1966 to \$20 million in 1972, with \$8 million to be spent in-house, and \$12 million to be contracted out.<sup>275</sup> Reality was much harsher; the FY 1972 appropriations were approximately \$2.1 million.<sup>276</sup> The program nevertheless flourished and by the time the NSRDS legislation was passed, it was producing a steady stream of data compilations. Appropriations were growing, albeit at a rate that euphemistically could only be called leisurely. But other agencies, and the Bureau's RTS appropriation coupled to reprogramming, helped. And the data centers, both inside and outside the Bureau, had other sources of funds.

By 1970 there were thirty-four established data centers associated with the NSRDS, fifteen of them at the Bureau. In addition, individual "one-shot" projects for special data compilations or critical reviews were supported. Some of the data centers outside the Bureau received no funding from the Office of Standard Reference Data (OSRD), but nevertheless were associated with the system, as had originally been envisioned by the Bureau and the FCST.

The whole technical program was divided into seven areas: (1) Thermodynamic and Transport Properties, (2) Atomic and Molecular Data, (3) Chemical Kinetics, (4) Solid State Data, (5) Nuclear Data, (6) Colloid and Surface Properties, and (7) Mechanical Properties. In addition to these areas, research on the use of computers for data processing and dissemination was carried out.

In response to needs for data for industry and for national defense—and to some extent for historical reasons—the heaviest concentrations of data were found in thermodynamic and transport properties, with eleven data centers (two from the Bureau), and in atomic and molecular data with nine centers (seven from the Bureau). The least emphasized areas, at that time, were colloid and surface properties with one center, and mechanical properties with none.

---

<sup>274</sup> *Critical Evaluation of Data in the Physical Sciences—A Status Report on the National Standard Reference Data System, June 1970*, David R. Lide, Jr., ed., Natl. Bur. Stand. (U. S.) Technical Note 553; September 1970.

<sup>275</sup> Appropriations Hearings for 1967: 674.

<sup>276</sup> House Committee on Appropriations, Subcommittee on Departments of State, Justice, and Commerce, the Judiciary, and Related Agencies, *Departments of State, Justice, and Commerce, the Judiciary, and Related Agencies Appropriations for 1972: Hearings Before a Subcommittee of the Committee on Appropriations*, 92d Cong., 1st sess., National Bureau of Standards, 20 April 1971:1150. These figures represent only those funds controlled by the OSRD. The actual expenditures for data evaluation were much higher, because of support from other agencies and from RTS funds of the NBS technical divisions.



We cannot possibly describe all the work carried out. In thermodynamics and transport properties alone, seventeen projects were actively pursued in 1970, and fifteen monographs published between 1968 and 1970. We can at least list a few of the projects and centers drawn from the areas enumerated above to give a feeling for the type of work supported by the NSRDS.

- Selected values of chemical thermodynamic properties, Donald D. Wagman and William H. Evans, Physical Chemistry Division, NBS.
- Thermal conductivity of selected materials, Y. S. Touloukian, Thermo-physical Properties Research Center, Purdue University.
- Thermodynamic data on organic compounds, Bruno J. Zwolinski, Texas A&M University.
- Atomic Energy Levels Data Center, William C. Martin, Charlotte Moore Sitterly, Optical Physics Division, NBS.
- Atomic Collision Cross Section Information Center, Lee J. Kieffer, JILA, NBS/University of Colorado.
- Chemical Kinetics Data Center, David Garvin, Physical Chemistry Division, NBS.
- Critical evaluation of the gas phase reaction kinetics of the hydroxyl radical, William E. Wilson, Jr., Battelle Memorial Institute.
- Crystal Data Center, Helen M. Ondik, Inorganic Materials Division, NBS.
- Superconductive Materials Data Center, Benjamin W. Roberts, General Electric Research and Development Center.
- Diffusion in Metals Data Center, John R. Manning, Metallurgy Division, NBS.
- Photonuclear data, Everett G. Fuller, Linac Radiation Division, NBS.
- Electrochemical properties of interfaces, Johannes Lyklema, Agricultural University of Wageningen, The Netherlands.

It can be said that by 1970 the NSRDS was an established part of the Bureau's activities and the Nation's scientific infrastructure.

## Weights and Measures for the States

In 1832, Secretary of the Treasury Lewis McLane, in the course of his coinage and customhouse functions, directed Ferdinand R. Hassler, his superintendent of the Coast Survey, to prepare copies of a set of standards that Hassler had recommended in reports he had prepared at the secretary's request. These were standards of length, weight, and volume derived from British standards, and in due course they were adopted by the Treasury. Congress, recognizing the value of uniformity in weights and measures, in an 1836 joint resolution directed the secretary to deliver copies of Hassler's standards "to the governor of each State in the Union . . . to the end that a uniform standard of weights and measures may be established throughout the United States." These were the first nationwide standards in the country, and were quickly adopted by the states as their legal standards, although the Congress had not legalized them. In 1864, Great Britain authorized the use of the metric system along with its own imperial system, and Congress, following suit in 1866, legalized the metric system in the United States. In that same year, the Congress, in another joint resolution, directed the secretary of the treasury to furnish each state with a set of metric weights and measures standards. By 1880 this had been largely accomplished and practically all states had weights and measures standards.<sup>277</sup>

But circumstances in the states had changed. As Allen Astin testified in 1965:

"Since that time the States that have become members of the Union have acquired standards by one way or another. We provided them for the two most recent States, Alaska and Hawaii, but many of the States have lost their standards and none of them has standards adequate to meet the demands of standards metrology, the standards of measurement."<sup>278</sup>

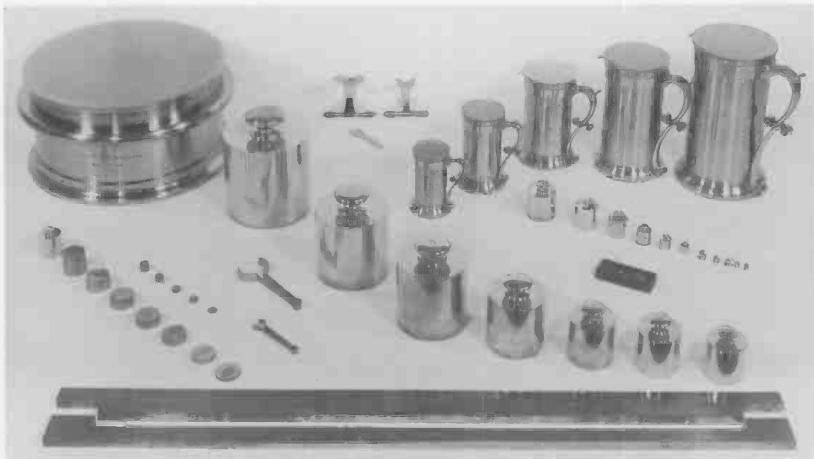

Customary standards furnished to the states under the Joint Resolution of 1836.

<sup>277</sup> See MFP, 24-28 for an account of this early history, and MFP, 515-526 for a biography of F. R. Hassler.

<sup>278</sup> Appropriations Hearings for 1966: 494-495.

A 13-year program provided working weights and measures laboratories with uniform and accurate standards in all of the 53 States and territories. The 95-piece set of weights, measures, and weighing instruments are standards in both the U.S. customary system and the metric system.



The State of Maryland received its set of weights and measures on April 3, 1970 in the Bureau's Red Auditorium.

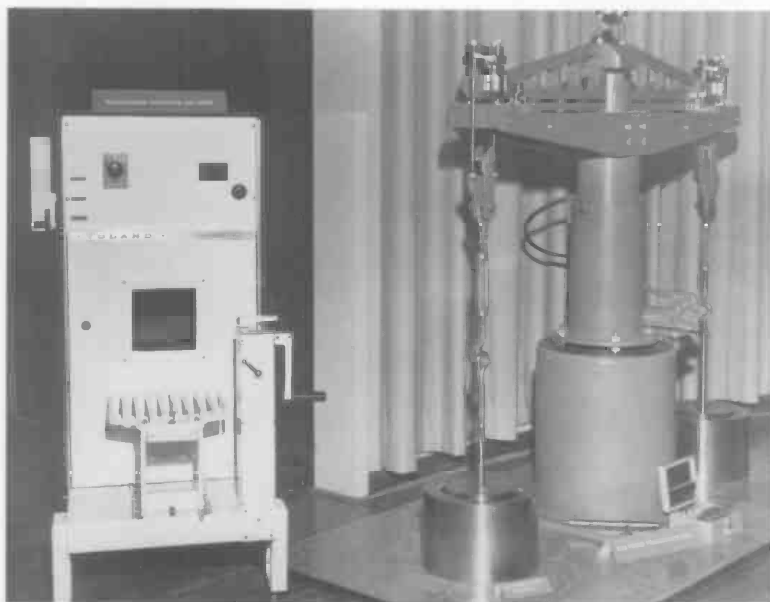

The 30 kilogram precision balance, the 2500 pound precision balance, and the 500 pound mass standard received by the State of Maryland.

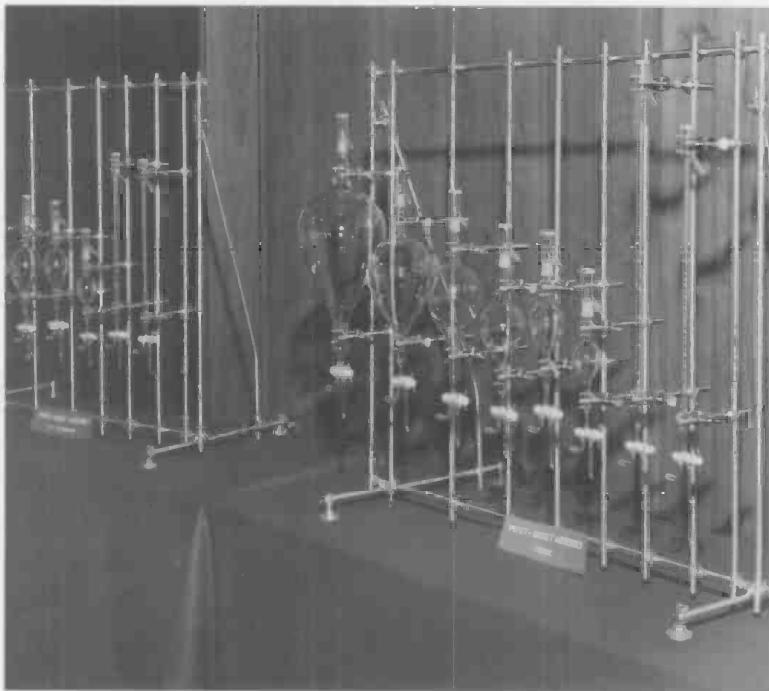

Sixteen volume standards, including 12 pipets and 4 burets, were part of the set received by the State of Maryland.



A portion of the 67 mass standards (metric and avoirdupois) presented to the State of Maryland are shown here.

He therefore requested \$500 000 to begin a program of constructing and distributing standards for the states, and providing training in their use. It was expected that each set of standards, plus the associated training, would cost about \$40 000, and that the \$500 000 would be enough to equip about one-fourth of the states. After a modicum of discussion about why the states could not pay for the standards, and being reassured that free distribution would help attain national uniformity plus the fact that each of the states could be expected to create a new or expanded weights and measures laboratory and qualified personnel, the Congress appropriated the funds necessary to start the program.<sup>279</sup>

Each state was to receive a complete set of stainless steel weights in both metric and customary units, from 30 kilograms to 1 milligram, and from 50 pounds to 0.000 001 pound, plus two 500 pound stacking weights; various graduated tapes and rules and a 16-foot-long bench equipped with a precision microscope and tension weights; volumetric standards from 5 liters to 1 milliliter, and from 5 gallons to 1 minim (0.003 76 cubic inches); and five precision balances from 100 gram capacity to 5000 pound capacity. All were, of course, to be calibrated or adjusted by the Bureau before distribution.

The schedule, which called for equipping ten states per year and completion of the program in a few years, could not be maintained, nor could the \$40 000 price. By 1973, 40 states had been equipped and the price had doubled, partly because the specifications had been raised. The complete equipping of the 53 states and territories was not completed until 1978. But upon its completion it could be said that for the first time in its history the Nation was equipped to provide complete uniformity in weights and measures, and all measurements in trade and commerce were at least in principle traceable to the national standards maintained by the Bureau.

### Federal Information Processing Standards

It will be recalled that under the Brooks Act (PL 89-306), the Bureau, through the secretary of commerce, was given responsibility "to make appropriate recommendations to the President relating to the establishment of uniform Federal automatic data processing standards." The task of fulfilling this responsibility, along with the others spelled out in the legislation, was given to the newly formed Center for Computer Sciences and Technology. Under policy guidance from the Bureau of the Budget, the program of the center was separated into four elements: Advisory and Consulting Services, Standards, Research, and Computer Services. Standards was by far the largest program, spending approximately \$4.24 million out of a total of \$9.35 million in the period FY 1965 to FY 1971.<sup>280</sup>

<sup>279</sup> "Ten States to Receive New Standards," *Technical News Bulletin* 50 (1966): 181; "Three States Receive New Weights and Measures Standards," *Technical News Bulletin* 52 (1968): 30-31; "Three States Receive Weights and Measures Standards," *Dimensions* 57 (1973): 191; and "For Good Measure," *Dimensions* 62 (11) (1978): 2-7. The last article gives a good, short historical account of the history of weights and measures distribution, and of the relationship of the states, who have the responsibility to enforce weights and measures in the marketplace, with the Bureau, which has the custody of the national standards.

<sup>280</sup> Center for Computer Sciences and Technology, "Brooks Bill Issue Study of the National Bureau of Standards," NBS Report 10608, September 1971.

To implement its responsibilities, the Bureau divided the CCST standards area into four categories: (1) Hardware standards, including such items as character recognition, interchange codes and media, transmission, interface, and keyboards; (2) Software standards, including programming languages and operating systems; (3) Applications standards; and (4) Data standards, including representation of data elements and codes, and formats.<sup>281</sup> Also, because these standards had to be used in all agencies of the Federal Government, the Bureau recognized that it needed to “coordinate its activities on an interagency basis.” For this purpose it formed a series of ad-hoc task groups designed to provide advice to the Bureau on specific standards, to make recommendations on specific problems, and to develop draft proposals.<sup>282</sup> The chairs of these task groups in turn were collected into an Advisory Committee, for which the chair was the chief of the Office of Information Processing Standards. Other members included representatives from the BOB and General Services Administration (GSA), the other main agencies besides the Bureau having functions under the Brooks Act, and other persons as necessary.

With policy guidance from the BOB, a new publication series called the Federal Information Processing Standards Publications or, more commonly, FIPS PUBS, was initiated. These publications were to be used in the promulgation of standards, for establishing new standards, and in clarifying existing ones. The Bureau was also directed to maintain a FIPS PUBS Register, which was the “official source within the Federal Government for information pertaining to the approval, implementation, and maintenance of Federal Information Processing Standards. . . .”<sup>283</sup>

Because the development of these standards required coordination with the myriad interested parties both in the Government and in the private sector, standards did not come immediately. On March 11, 1968—some two and one-half years after the enactment of the Brooks Act—three automatic data processing (or FIPS) standards were approved by President Johnson. The most important of the three was the first, which established the USA Standard Code for Information Interchange (USASCII), which consisted of 128 seven-bit binary numbers used to represent 32 control characters and 96 symbols—letters, numbers, punctuation marks, and the other customary symbols used in the English language. The whole was referred to as a “coded character set.”

Developed in an effort begun in 1960 by the American Standards Association (ASA), now the American National Standards Institute (ANSI), USASCII was recommended by the International Standards Organization (ISO) and the International Telegraph and Telephone Consultative Committee (CCITT). All computers procured by the Federal Government after July 1, 1969, had to be capable of using USASCII. As is well-known to all users of PC word processors, the ASCII set, as it is now known, is based on the eight-bit binary, or 256 characters. Those beyond 128 are often called

---

<sup>281</sup> *General Description of the Federal Information Processing Standards Register*, Natl. Bur. Stand. (U.S.) Federal Information Processing Standards Publication 0; November 1, 1968: 3.

<sup>282</sup> “FIPS Coordinating and Advisory Committee,” *Technical News Bulletin* 53 (1969): 185-187.

<sup>283</sup> *General Description of the Federal Information Processing Standards Register*: 1-2.

the "extended ASCII character set." Also approved at the same time were standards for recording the code on magnetic and paper tape. With this capability, all future computers in the Federal Government were expected to be able to communicate with one another.<sup>284</sup>

By 1971, six more standards had been issued, including such items as calendar dates, metropolitan statistical areas, and state name abbreviations. These were developed through the program the BOB had developed in response to its own responsibilities under the Brooks Act. Six more were approved on June 18, 1971, by the director of the Office of Management and Budget (OMB), the successor of the BOB. These six were technically based standards developed under the Bureau's program.<sup>285</sup> By Executive Order 11717, on May 9, 1973, the responsibilities of OMB with respect to Government-wide data processing standards were transferred to the secretary of commerce.<sup>286</sup>

## THE GENERAL RESEARCH

### Superconducting Semiconductors

Approximately half the program of the Institute for Basic Standards was concerned with the measurement of the physical properties of well-defined substances.<sup>287</sup> Due to its close association with the temperature scale, IBS had assumed responsibility for many thermodynamic and transport properties. This kind of work was carried out in the Heat Division and the Solid State Physics Section of the Atomic Physics Division, among others. Thus it was not surprising that a joint study of superconductivity in semiconductors should take place between workers from these two organizational units.

The possibility that semiconductors might exhibit superconductivity had intrigued scientists for some time, and in two 1964 papers, Marvin L. Cohen of the University of California, Berkeley, analyzed the problem in great detail.<sup>288</sup> He showed that under appropriate conditions—high charge carrier density, large electron effective mass, high dielectric constant, strong interaction between electrons and lattice vibrations—semiconductors could indeed be expected to show superconductivity.

---

<sup>284</sup> "President Approves Federal ADP Standards: USACII to Extend Compatibility," *Technical News Bulletin* 52 (1968): 173.

<sup>285</sup> Center for Computer Sciences and Technology, "Brooks Bill Issue Study of the National Bureau of Standards": VI.6-VI.9.

<sup>286</sup> Executive Order 11717, May 9, 1973. *Code of Federal Regulations*, Title 3, 1971-1975 Compilation: 766-768.

<sup>287</sup> Annual Report for 1968: 61.

<sup>288</sup> M. L. Cohen, "Superconductivity in Many-Valley Semiconductors and in Semimetals," *Physical Review* 134 (1964): A511-A521; M. L. Cohen, "The Existence of a Superconducting State in Semiconductors," *Reviews of Modern Physics* 36 (1964): 240-243.

Very quickly, and almost simultaneously, groups from the Naval Research Laboratory (NRL) and the Bureau reacted. At the NRL the work was with germanium tellurides of several different compositions, and the material showed superconductivity below about 0.3 K.<sup>289</sup> At the Bureau, James F. Schooley of the Cryogenic Physics Section and William R. Hosler of the Solid State Physics Section, with the collaboration of Cohen, worked with the semiconductor strontium titanate, a material

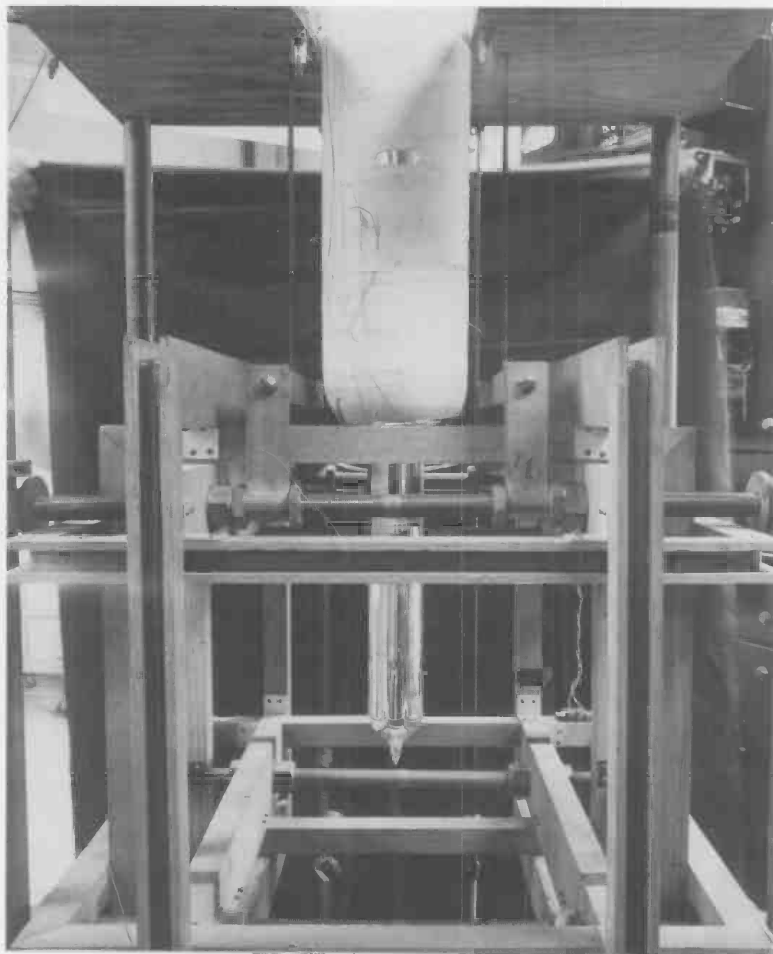

Using the apparatus formerly employed in the parity experiments, a University of California/NBS group found that superconductivity could occur in oxide semiconductors. The group included Marvin L. Cohen, professor of physics at UC; his student Calvin S. Koonce, Hans P. R. Frederikse and William R. Hosler of the NBS Solid State Physics Section; and James F. Schooley, Ernest Ambler, Jack H. Colwell, and Earl R. Pfeiffer of the NBS Cryogenic Physics Section.

<sup>289</sup> R. A. Hein, J. W. Gibson, R. Mazelsky, R. C. Miller, and J. K. Hulm, "Superconductivity in Germanium Telluride," *Physical Review Letters* 12 (1964): 320-322.





Earl R. Pfeiffer (left) and Calvin S. Koonce positioned a Dewar inside a magnet in preparation for an experiment to determine the superconducting transition temperature of strontium titanate as a function of conduction electron concentration.

with which the Solid State Physics Section had a great deal of experience. An oxide semiconductor, it had the advantage that the number of carriers could be controlled by reduction, a relatively easy process of heating the material in either a vacuum oven or in the presence of hydrogen. Single crystals were available and remained intact during the processing.

The material did indeed show superconductivity between 0.2 K and 0.3 K. Moreover, experiments on the Meissner effect (the property of a superconductor that causes it to exclude all magnetic fields from its interior) showed that the material was a

type II or "hard" superconductor.<sup>290</sup> Later, more extensive experiments were carried out. Samples covering carrier densities over a three-decade range showed that, as the carrier density was increased, the transition temperature rose, reached a maximum at a carrier density of  $10^{21}$  per cubic centimeter, and then decreased again. The transition temperature covered was from 0.05 K to 0.30 K. Its behavior followed that predicted theoretically by Cohen and his student Calvin S. Koonce.<sup>291</sup> Strontium titanate was the first known oxide superconducting semiconductor. But it was a single oxide. Had there been leisure to try multiple oxides, the high-transition-temperature superconductor revolution that occurred in the mid-eighties might have occurred some twenty years earlier.

### Electron Scattering From Nuclei

The Bureau's linear electron accelerator was accepted from the contractor in October 1965. One of the most natural things to do with the powerful 150 MeV accelerator was to study the atomic nucleus by electron scattering, and the time for such studies was propitious. In 1970 Samuel Penner, of the Linac Radiation Division, wrote:

For many years it has been said that electron scattering is a powerful tool for the study of nuclear structure, because quantum electrodynamics is a very accurate theory and because the weakness of the electromagnetic interaction allows accurate theoretical interpretation of experimental results. In spite of these advantages, electron scattering has in the past contributed little to our understanding of the nucleus, in contrast to the vast amount of information obtained by reaction studies employing nuclear particles (protons, alphas, etc.). This situation has changed greatly in recent times, and electron-scattering is at last proving its great value as an experimental technique for the study of nuclear properties.

As a result of recent improvements in experimental techniques and apparatus we are now able to perform detailed and accurate experiments which yield valuable information on nuclear structure. . . .

The main reasons that we are now able to perform experiments of this quality are: (1) the development of the modern electron linear accelerator . . . ; (2) better understanding of the principles of beam transport . . . ; (3) improvements in the design and construction of magnetic spectrometers . . . ; (4) the development of multi-channel "ladder" detector systems; (5) improved methods of beam current monitoring; and (6) the use of on-line computer systems. . . .<sup>292</sup>

<sup>290</sup> J. F. Schooley, W. R. Hosler, and M. L. Cohen, "Superconductivity in Semiconducting  $\text{SrTiO}_3$ ," *Physical Review Letters* 12 (1964): 474-475.

<sup>291</sup> J. F. Schooley, W. R. Hosler, E. Ambler, J. H. Becker, M. L. Cohen, and C. S. Koonce, "Dependence of the Superconducting Transition Temperature on Carrier Concentration in Semiconducting  $\text{SrTiO}_3$ ," *Physical Review Letters* 14 (1965): 305-307; "Superconducting Transition Temperatures of Strontium Titanate Semiconductor," *Technical News Bulletin* 52 (1968): 48-49.

<sup>292</sup> Samuel Penner, *Experimental Techniques for Electron Scattering Investigations*, Natl. Bur. Stand. (U.S.) Technical Note 523; April 1970: 1-2.

Electron scattering can indeed provide basic information on nuclear structure. From elastic scattering studies comes information about nuclear sizes and shapes, and from inelastic scattering comes information about the energy level structure of nuclei, including the spin, parity, and transition strength of the excited nuclear states. But before the LINAC beam could be used for any of this work, it was necessary to build a spectrometer required to study atomic spectra and obtain information about atomic states. Such a spectrometer was built by Samuel Penner, John W. Lightbody, Jr., and Sherman P. Fivozinsky of the Linac Radiation Division. In a typical experiment, the beam from the LINAC was impinged on a target of the material to be studied, and the scattered electrons passed through a solid-angle-defining slit. They then passed through a momentum-selecting bending and focusing spectrometer magnet, and were finally detected by a focal-plane array of small, solid-state detectors. Operated under computer control, the final output of such measurements was a plot of the number of scattered electrons per unit of energy per incident electron vs. the energy of the scattered electron for a given scattering angle or momentum transfer. The energy resolution of the whole instrument was 0.08 percent—sufficient for high-quality work.

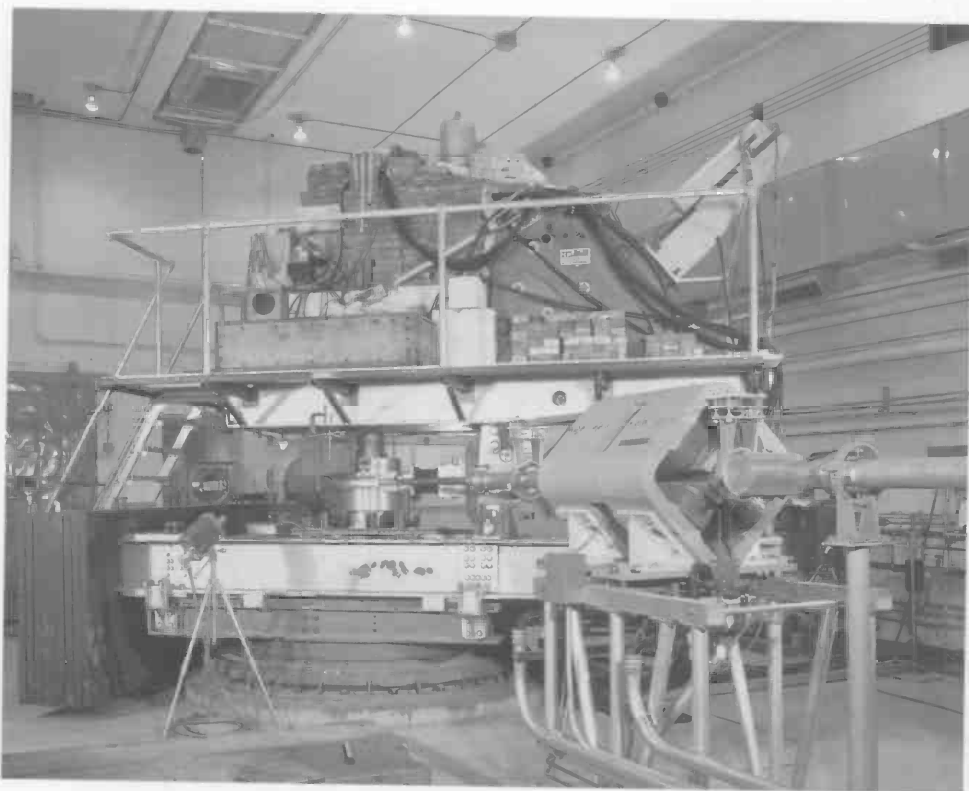

The NBS electron scattering spectrometer.

In collaboration with guest workers from MIT, the University of Maryland, Catholic University, American University, the University of Massachusetts, Virginia Polytechnic Institute, and the Laboratoire de l'Accélérateur Linéaire, Orsay, France, quite a number of different nuclei were studied. In all cases, the main object was to compare experimental results with the predictions of theory. The Bureau leaders in the studies were Lightbody, Penner, and Fivozinsky. Thus, in one of the first experiments, form factors for the excitation of low-lying states of  $O^{16}$  were determined.<sup>293</sup> Another of the points of interest was the comparison of the giant resonance in  $C^{12}$  with that in the isotope  $C^{13}$ , with the result that "the addition of a neutron to the even-even  $C^{12}$  system results in a major restructuring of the giant resonance strength."<sup>294</sup> Other studies in this fruitful area were concerned with the electron scattering sum rule for  $C^{12}$  (1970); elastic scattering from  $Ti^{46}$ ,  $Ti^{48}$ ,  $Ti^{50}$ , (1971); electron scattering for one- and two-phonon vibrational states (1972); electron scattering from Zn isotopes (1972); quadrupole and hexadecapole deformation parameters of  $Sm^{152}$  (and other heavy deformed nuclei) by electron scattering (1972); electron scattering studies of vibrator-spectrum nuclei:  $Cr^{52}$ ,  $Pd^{116}$ ,  $Cd^{114}$ ,  $Sn^{116}$  (1972); electron scattering from low-lying states in  $C^{14}$ , (1972); low  $q^2$  electron scattering from the 15.109 MeV state of  $C^{12}$  and conserved-vector-current test (1973); and electron scattering from  $F^{19}$  and  $Ca^{40}$  (1973). An outpouring of basic research in nuclear physics came from the new instrument.

### Making the Draft Lottery Impartial

The first draft lottery since World War II was held in December 1969, and questions were raised about its impartiality, or randomness. To ensure that a second lottery, planned for July 1, 1970, would be impartial, the Selective Service System (SSS) asked the Bureau to provide it with sets of twenty-five "random calendars" and twenty-five random permutations of the numbers 1 to 365.<sup>295</sup> These calendars and permutations were to be used to determine the priority order in which youths born on a given day in 1951 would be drafted. One of the random calendars would be used to determine the sequence in which dates would be entered into 365 red capsules, and one of the random permutations would determine the order in which numbers used to determine the priority, or "rank," were placed into 365 green capsules. A second permutation would determine the order in which the red and green capsules were

<sup>293</sup> J. C. Bergstrom, W. Bertozzi, S. Kowalski, X. K. Maruyama, J. W. Lightbody, Jr., S. P. Fivozinsky, and S. Penner, "Electroexcitation of the Low-Lying States of  $O^{16}$ ," *Physical Review Letters* 24 (1970): 152-155.

<sup>294</sup> J. W. Lightbody, Jr., and S. Penner, "Electroexcitation of the  $C^{12}$  Giant Resonance," *Physical Review Letters* 24 (1970): 274-276; J. C. Bergstrom, H. Crannell, F. J. Kline, J. T. O'Brien, J. W. Lightbody, Jr., and S. P. Fivozinsky, "Electroexcitation of the Giant Resonance of  $^{13}C$ ," *Physical Review C* 4 (1971): 1514-1532. Giant resonances are excitations of the nucleus that occur with great strength in a narrow energy region. Usually studied by excitation with gamma radiation, they can also be studied by inelastic electron scattering. The nucleus can lose its excitation by emitting a gamma ray, or, in some cases, a particle. Three types of giant resonances are known: electric dipole, magnetic dipole, and electric quadrupole.

<sup>295</sup> J. R. Rosenblatt and J. J. Filliben, "Randomization and the Draft Lottery," *Science* 171 (1971): 306-308; "NBS Provides Random Tables for Use in Draft Lottery," *Technical News Bulletin* 54 (1970): 196-197.

loaded into two drums from which drawings would alternately be made. This procedure would give the order in which men, based on their birthdays, would be called up in the draft. No bias was to be allowed to enter the system.

The mathematical problem was to generate fifty random permutations of the numbers 1 to 365, twenty-five to be used for calendars, and twenty-five to be used for ranking.<sup>296</sup> These could have been generated on a computer, but there already existed thirty-eight tables of random permutation of numbers 1 to 500, and twenty tables for numbers 1 to 1000.<sup>297</sup> Aside from saving work, use of these published tables had the added advantage of permitting the work to be reproduced. Cutting off the first tables at 365 yielded thirty-eight tables. By cutting the second tables into one set for numbers 1 to 365, and a second set for numbers 501 to 865, forty permutations 1 to 365 were formed. This gave seventy-eight permutations of numbers 1 to 365.<sup>298</sup> These had to be cut down to fifty tables.

To do this, two sets of the seventy-eight permutation tables were prepared, one from which the calendars would come, and the other for the ranking permutation. Then numbers between 1 and 78 were selected by the throws of three dice, thrown by three members of an advisory panel for the project, and referenced to other existing permutation tables from Moses and Oakford's *Tables of Random Permutations*. These again were random permutations, but now of numbers from 1 to 78. The adopted protocol was that if the number was between 1 and 25, the priority permutation for that number would be chosen, and the calendar permutation discarded. For numbers from 26 to 50, the opposite would be done. For numbers from 51 to 78, both calendar and priority permutations with those numbers would be discarded. In this way, twenty-five calendars and twenty-five priority permutations were chosen, each one sealed in an unmarked envelope, and delivered to the SSS, the Bureau's work having been accomplished. As near as mathematics could determine, everything was totally random and impartial.

On June 29, two days before the actual drawing, an official lottery witness chose one of the sealed envelopes containing random calendars. He chose the one that contained calendar number 53, and the dates of the year were placed into 365 red capsules in the sequence of dates for this calendar. Similarly, one of the twenty-five rank, or priority, envelopes was chosen. It contained permutation number 43, and priorities 1 to 365 were placed into 365 green capsules in the order of permutation number 43. Finally, to complete the process of preparation for the drawing, another envelope from the twenty-four remaining "priority" envelopes was chosen. It contained permutation number 45, and both the calendar and priority capsules were placed in their respective drums in the order of this permutation. It was about as random a process as could be imagined.

---

<sup>296</sup> The random calendar is nothing but a random permutation with a date attached to each number in the permutation. Thus, the problems of producing a permutation or a calendar are the same.

<sup>297</sup> Lincoln E. Moses and Robert V. Oakford, *Tables of Random Permutations* (Stanford, California: Stanford University Press, 1963).

<sup>298</sup> The reader may be interested to know that there are approximately  $2.51 \times 10^{778}$  such sets. The Bureau used only seventy-eight of them.

On July 1, 1970, with dignitaries and the press present, the drawing took place.<sup>299</sup> The calendar drum rotated for an hour, but the priority drum malfunctioned and rotated for only a half hour. Nevertheless, subsequent analysis showed that the mixing was successful. The first date chosen was number 259, or September 16, with a rank of 139. It was looked upon as a successful job for all concerned.

### Research at the Reactor

On December 7, 1967, at 3:55 in the afternoon, the Bureau's reactor, sporting its new acronym NBSR, achieved criticality, but was not ready for routine use.<sup>300</sup>



Staff of the Bureau's research reactor await celebration of the moment of criticality, which was achieved at 3:55 p.m. on December 7, 1967. Standing left to right in the foreground were the reactor's designers: Harry Landon, Carl Muehlhause, and Robert S. Carter. Seated in the foreground were Ray Meschke (at table) and Tawfik Raby (right). Standing left to right against the back wall were John Ring, James Knight, Nathan Bickford, and four Atomic Energy Commission officials.

<sup>299</sup> An apocryphal story relates that when it was announced that the procedure had been developed by the National Bureau of Standards, a large number of the press left. When asked why, one of the reporters said, "Well, if they're the guys who did this then nothing is going to go wrong, and that's not news."

<sup>300</sup> "NBS Reactor Achieves Criticality," *Technical News Bulletin* 52 (1968): 50.

Before such use, the reactor had to undergo extensive testing and mapping of its operating characteristics, the effect of loading and core configuration on the flux in the beam tubes had to be determined, and maps of the flux in the core had to be made so that fuel life could be estimated accurately. With these and other tests carried out, NBSR went into full 10 MW service in late summer, 1969.<sup>301</sup>

It had been planned that the NBS reactor would be a national facility, available to scientists from Government, industry and universities. In many cases, this would lead to cooperative work with scientists on the staff of the Bureau's Reactor Radiation Division. Thus the division had staff of two kinds: scientific researchers, and engineering and maintenance personnel. The former carried out their own research programs while the latter bore the division's responsibility to operate and maintain the reactor. The research staff actively sought out collaboration with research workers within and outside the Bureau, particularly those new to research on the reactor and not aware of its outside capabilities. These people often required instruction in working with neutron beams. Formal long-term interagency arrangements were sometimes made under which other-agency scientists were actually stationed at the reactor. One of the first such agreements was made in September 1970 with the local Naval Ordnance Laboratory (NOL), and later another was made with the Picatinny Arsenal when an army reactor in Watertown, Massachusetts, was shut down.<sup>302</sup> Finally, workers from other Bureau divisions used the reactor directly rather than in collaboration with reactor personnel. Prominent among these last were scientists from the nuclear physics programs of the Center for Radiation Research, and others from the Analytical Chemistry Division who routinely irradiated samples for neutron activation analysis and who, in fact, had their own laboratory in the Reactor Building. In its first year of operation, a total of twenty-five workers from other Bureau divisions spent sixteen man-years working at the reactor, either alone or cooperatively with reactor scientists. From outside the Bureau, thirty-two scientists spent twelve man-years of effort at the NBSR. It was a pace that would increase rapidly in later years.

By August 1970, experimental equipment at the reactor included four neutron and x-ray diffractometers, and a crystal time-of-flight instrument to be used in inelastic scattering studies. Under development was a triple-axis spectrometer for crystal-dynamics studies. A high-volume cold-neutron source that used D<sub>2</sub>O, heavy ice, was under development. It was completed in 1987 and used until 1994. A new cold source using liquid hydrogen was introduced in 1995. All the diffractometers were under the control of a single mini-computer, which operated on a time-shared basis.

A great deal of crystal structure work was carried out by combining x-ray and neutron-diffraction techniques in situations where the neutron's ability to "see" light elements was essential to the structure determination. Thus, the crystal structure of a number of complex metal organics and simpler molecules like phosphonium bromide

---

<sup>301</sup> *Reactor Radiation Division: Annual Progress Report for the Period Ending October 31, 1970*, Robert S. Carter, ed., Natl. Bur. Stand. (U.S.) Technical Note 567; March 1971; "Research at NBS Reactor," *Technical News Bulletin* 54 (1970): 174-176.

<sup>302</sup> "Cooperative Program Engages NBS Reactor," *Technical News Bulletin* 54 (1970): 157.

were worked out. Inelastic scattering was used in the study of the diffusion and modes of vibration of hydrogen in transition-metal hydrides, and in the study of the rotator phase in *n*-alkanes, specifically *n*-nonadecane (C<sub>19</sub>H<sub>40</sub>).

Liquids and amorphous solids were not neglected. The structure factor—from which the radial distribution function could be calculated—in liquid neon was determined to compare with theoretical calculations. Similarly, liquid aluminum was studied to determine the pair distribution function, and a program to study the structure of glassy solids was initiated. A great advantage of neutrons is that the neutron possesses a magnetic moment and hence can be scattered by other magnetic moments. Thus, in collaboration with workers from NOL, studies were carried out on rare-earth iron garnets, transparent magnetic fluorides such as RbNiF<sub>3</sub> and CsFeF<sub>3</sub>, and on cubic praseodymium compounds.

As already mentioned, other divisions of the Bureau were also users of the reactor facilities. One of the major users was the Activation Analysis Section of the Analytical Chemistry Division. For this section, the reactor was simply a source with which to irradiate their samples with neutrons of the proper energy, thus converting impurities or minor elements in their samples to radioactive species, so that subsequent measurements of the radioactivity would permit the determination of their concentration. The method is exceedingly sensitive. And the reactor was not the only neutron source used. Others were the 3 MeV and 14 MeV neutron generators in the CRR, and the LINAC for photon activation analysis.

Other nonreactor-division users were concerned with basic nuclear physics. Thus, there was a search for weak parity-violating interactions in the nucleon interactions—a program carried out in collaboration with scientists at Harvard University and Brookhaven National Laboratory. Other nuclear physics investigations concerned two-photon emission in (n,p) capture, decay characteristics of krypton isotopes, and nuclear orientation studies on Br<sup>82</sup>.

Finally, other organizations turned to the reactor for more prosaic—but not unimportant—work. In July 1970 the Bureau entered into an agreement with the Post Office Department, Internal Revenue Service, U.S. Geological Survey, Federal Bureau of Investigation, and the Food and Drug Administration for the use of the reactor for neutron-activation analysis. The bulk of the work would be for forensic purposes. Each of the agencies was lavish in praising the NBS reactor facility and the generous and knowledgeable assistance of the CRR staff.<sup>303</sup>

### Critical Phenomena

In 1954, Melville Green, a young theorist working on the statistical mechanics of fluids, was hired by the Heat Division. In keeping with Astin's desire to emphasize theoretical work, the division in 1960 created a section primarily concerned with theory called Statistical Physics and appointed Green as its chief. One of Green's principal interests at the time was the generalization of kinetic theory to dense gases, i.e., gases at high temperature.<sup>304</sup>

<sup>303</sup> *Reactor Radiation Division: Annual Progress Report for the Period Ending October 31, 1970*: 48-55.

<sup>304</sup> Interviews with Johanna M. H. L. Sengers and Jan V. Sengers.





Melville S. Green came to the Bureau in 1954 and from 1960 to 1968 was the first chief of the Heat Division's Statistical Physics Section. Phenomena at the critical point was the primary interest of this section.

It was perhaps inevitable that any group concerned with phenomena—particularly in fluids—at extremes of temperature and pressure should become concerned with phenomena near and at the critical point, where properties change rapidly and anomalously. For Green and his section, phenomena at the critical point, or more briefly “critical phenomena,” became the dominant interest.

The early sixties was an advantageous time to become involved with critical phenomena. Both theoretical and experimental investigations were discovering new information and converging towards new concepts. The predictions of classical “mean-field” theories for fluids (Johannes van der Waals), magnetism (Pierre Weiss), and order-disorder in alloys (William Lawrence Bragg, Evan J. Williams), which had been developed in the early half of the 20th century, and had many features in common, were shown to be quantitatively incorrect near the critical points of all these different systems. These mean-field theories, for example, predicted finite values for the heat capacity at constant volume (fluids) or at constant field (magnetic materials). Experimentally, however, it was found in both these systems that the heat capacity shows a lambda-like divergence, as had already been observed in liquid helium at the superfluid transition. Such logarithmic divergences are of great interest to theorists and

would have led to excitement even without the rigorous solution by Lars Onsager in 1942 of the Ising model in two dimensions, which showed such a logarithmic divergence for the critical-point heat capacity in magnetic materials.<sup>305</sup>

Further, near a critical point, fluids and magnetic materials develop long-range fluctuations which lead to the phenomenon of critical opalescence, once studied by Einstein and more precisely described by Leonard S. Ornstein and Frits Zernike. Green was one of the first to warn that the classical Ornstein-Zernike theory might be incorrect, and later experiments near the consolute (critical) point of partially miscible binary liquids proved him correct.

Perhaps the most exciting aspect of the field was the close analogy displayed by so many very dissimilar systems.<sup>306</sup> The shape of the coexistence curve of a fluid, or of partially miscible binary liquids near a critical point is, for instance, very like that of the curve of spontaneous magnetization of an uniaxial magnetic substance near its Curie point. Both of these shapes could be expressed by so-called power laws, connecting the difference of coexisting densities of fluids, coexisting compositions in binary liquids, and magnetization in magnetic materials, with a power of the temperature difference from the critical point. The exponent turned out to be the same in all these cases, but it did not have the mean-field value. Rather, the experimental values were reasonably close to those calculated for the three-dimensional Ising model at that time.

Analogous behavior was observed for other properties, such as compressibility in the fluid and susceptibility in the magnet. The power law, or critical exponent for this property, is different from that for heat capacity, but it is the same in different systems. Although in principle many different critical exponents could be defined, they are not all independent. They have been shown to obey equalities called scaling laws, so that only two of them are independent.

With the rapid growth of theoretical understanding of critical phenomena and a flood of new experiments throughout the world producing new results, it was a time of creative excitement in the Statistical Physics Section similar to that felt in the Free Radicals Program. It was spurred by Green, and spilled over to other sections of the Heat Division, such as the Equation of State Section under Joseph Hilsenrath, and to other divisions, such as the Polymers Division, where the study of critical opalescence in polystyrene-cyclohexane solutions was begun.<sup>307</sup>

Green saw that this ferment, both within and outside the Bureau, made the time auspicious for a conference on critical phenomena, particularly since much of the work in the area was carried out by workers in different fields who normally did not interact.

---

<sup>305</sup> Melville S. Green, "Introduction" in *Critical Phenomena: Proceedings of a Conference Held in Washington, D.C., April 1965*, M. S. Green and J. V. Sengers, eds. Natl. Bur. Stand. (U.S.) Miscellaneous Publication 273; December 1, 1966: ix-xi.

<sup>306</sup> J. V. Sengers and J. M. H. Levelt Sengers, "The Critical Region," *Chemical and Engineering News* 46, (June 10, 1968):104-118.

<sup>307</sup> D. McIntyre, A. Wims, and M. S. Green, "Critical Opalescence of Polystyrene Solutions," *Journal of Chemical Physics* 37 (1962): 3019-3021.

Green organized and held the Conference on Phenomena in the Neighborhood of Critical Points at the Bureau from April 5 to April 8, 1965.<sup>308</sup> Attended by about 170 scientists, including George E. Uhlenbeck, previous president of the American Physical Society, and Nobel laureates Peter J. Debye and Chen N. Yang, the conference had sessions on equilibrium critical phenomena in fluids, critical phenomena in ferromagnets and antiferromagnets, logarithmic singularities, elastic and inelastic scattering, and transport and relaxation phenomena. An extra session on the last day of the conference discussed new ideas stimulated by the deliberations. It is generally recognized that this event—the first conference on critical phenomena—was important in developing this field of basic science. It forcefully impressed the idea of critical-point universality on the international audience. And it gave a boost to this field which, in 1982, culminated in the Nobel Prize for Kenneth Wilson of Cornell University. In addition, it spurred new directions for study, such as wetting and interfaces, liquid-crystal phase transitions, fractals, turbulence, and chaos.

After the conference, Jan V. Sengers, co-editor of the conference proceedings and a member of Green's section, initiated his work on aspects of critical opalescence, and the dynamics of critical behavior, with members of the Polymers Division, work which continued after he left NBS to join the University of Maryland in 1968. His wife, Johanna (Anneke) Levelt Sengers, a member of the Equation of State Section but, in her own words "drawn into Green's orbit," published a seminal paper with guest scientist Matilde Vicentini-Missoni and Green on the form of the nonclassical scaling laws for the behavior of fluids near critical points.<sup>309</sup> Raymond Mountain, in Green's section, wrote a paper that is now a classic on the spectrum of scattered light near the fluid critical point.<sup>310</sup>

In 1968, Green left the Bureau for a post at Temple University. The legacy he left, however, lasts to this day. In the Heat Division practical applications of the theory of critical phenomena to fluids of industrial importance, such as steam, ethylene, and carbon dioxide, contributed to making the Bureau a world-renowned center of expertise on new applications such as phase separation, chemistry and chromatography in fluid mixtures. This practical expertise coexisted with fundamental investigations,<sup>311</sup> such as the proof that fluid critical exponents truly have Ising values, and that the nonclassical critical exponent for the viscosity is really the same in fluids and fluid mixtures.<sup>312</sup> Later work (late eighties and early nineties) in the Polymers Division on the dynamics of phase transitions in polymer mixtures is also a legacy of the work begun by Green.

<sup>308</sup> M. S. Green and J. V. Sengers, *Critical Phenomena*.

<sup>309</sup> M. S. Green, M. Vicentini-Missoni, and J. M. H. Levelt Sengers, "Scaling-Law Equation of State for Gases in the Critical Region," *Physical Review Letters* 18 (1967): 1113-1117; M. Vicentini-Missoni, J. M. H. Levelt Sengers, and M. S. Green, "Scaling Analysis of Thermodynamic Properties in the Critical Region of Fluids," *Journal of Research of the National Bureau of Standards* 73A (1969): 563-583.

<sup>310</sup> R. D. Mountain, "Spectral Distribution of Scattered Light in a Simple Fluid," *Reviews of Modern Physics* 38 (1966): 205-214.

<sup>311</sup> R. Hocken and M. R. Moldover, "Ising Critical Exponents in Real Fluids: An Experiment," *Physical Review Letters* 37 (1976): 29-32; S. C. Greer, "Coexistence Curves at Liquid-Liquid Critical Points: Ising Exponents and Extended Scaling," *Physical Review A* 14 (1976): 1770-1780.

<sup>312</sup> R. F. Berg and M. R. Moldover, "Critical Exponent for Viscosity," *Physical Review A* 42 (1990): 7183-7186.

## Fracture Mechanics Comes to the Bureau

In December 1963 Sheldon M. Wiederhorn, a chemical engineer trained at Columbia and the University of Illinois, and who had then studied ceramics at DuPont, joined the Inorganic Solids Division. John J. Gilman had recently shown how the study of the fracture of solids could be used to determine their surface energy,<sup>313</sup> and what happened next is best told in Wiederhorn's own words:

Being newly employed at the National Bureau of Standards (NBS), I was searching for an experiment on the mechanical behavior of solids that would fit into a program on ceramic science . . . [Gilman's] method of characterizing fracture behavior of single crystals appealed to me, as it was new and dealt with a fundamental property of materials. Therefore, I designed equipment to duplicate Gilman's experimental technique. The equipment was built but never used, for while awaiting its construction, I had the idea that launched me into my investigations on the fracture of glass.

I realized that glass fracture could be studied if a method were devised to guide a crack along the midplane of a glass plate, so that double cantilever beam specimens of the type used by Gilman could be made. . . . In my first experiment I scratched the midplane of a microscope slide with a diamond scribe and found to my delight that the scratch could be used both to introduce a crack and to guide it once introduced. Initial experiments on precracked microscope slides indicated that, at about one-half the load for immediate failure, cracks in glass moved in a slow and controllable manner. This observation was in apparent contradiction to the Griffith criterion for fracture, which predicted a critical stress for spontaneous failure.<sup>314</sup>

Wiederhorn did not yet know that delayed failure in glass, a portion of which he had just observed and which he would elucidate thoroughly, was well recognized and called "static fatigue."

Thus began a series of experiments that was to provide new insight into the fracture of glass and other brittle materials. Using microscope slides as specimens, and readily available laboratory equipment, he studied the motion of cracks as a function of load. Having learned from papers by Richard J. Charles and by William B. Hillig<sup>315</sup> that the fracture of glass was a kinetic process controlled by water in the atmosphere, he did a series of experiments at different atmospheric humidities, measuring the velocity of

<sup>313</sup> J. J. Gilman, "Direct Measurements of Surface Energies of Crystals," *Journal of Applied Physics* 31 (1960): 2208-2218.

<sup>314</sup> "This Week's Citation Classic," *Current Contents—Engineering, Technology, and Applied Sciences* 19 (January 4, 1988): 14.

<sup>315</sup> R. J. Charles, "A Review of Glass Strength" in *Progress in Ceramic Science*, vol. 1, J. E. Burke, ed. (New York: Pergamon Press, 1961): 1-38; W. B. Hillig, "Sources of Weakness and the Ultimate Strength of Brittle Amorphous Solids" in *Modern Aspects of the Vitreous State*, vol. 2, J. D. MacKenzie, ed. (Washington, D.C.: Butterworth, 1962): 152-198.



Sheldon M. Wiederhorn observed the motion of a crack in a soda-lime glass with the aid of a traveling microscope. The specimen, a microscope slide, could be seen within the environmental chamber with two hooks attached to one end. The hooks, in turn, were attached to the jig of a testing machine that applied a stress to the sample. At the same time, a continuous stream of the desired atmosphere entered the test chamber by way of the white tubing in the background.

cracks as a function of load. The results were startling. The behavior showed three distinct regions. At low loads the velocity increased exponentially with the load. This was followed by a region in which the velocity was independent of the load, and finally a third region where the crack grew essentially catastrophically. This type of behavior was the same at all humidities, but the effect of water vapor was dramatic, with the velocity increasing substantially as the atmospheric moisture content was increased.

The crack growth behavior had a ready explanation in terms of the reaction of glass with water. In the low-load region, the rate-limiting step is the reaction of glass with water at the crack tip. In region II, the constant-velocity region, the rate of crack advance is limited by the rate of transport of water to the crack tip, and finally, in the region where the behavior is independent of water, the intrinsic breaking strength of the glass is reached.

There were many ways to proceed from these results, for a whole new area of fracture science had been opened. First was the relatively minor matter—at least in this case—of using the overall load as the crack extension force. Modern fracture mechanics had shown that crack-tip stress was controlled by the so-called stress intensity factor, which, aside from geometric factors pertaining to the actual experimental situation, is the macroscopic stress multiplied by the square root of the crack length. In all later publications this factor was used in place of the load, and the work joined the mainstream of modern fracture mechanics. Second, the technique could be used to study other materials, and other vapors besides water. Sapphire was one of the first additional materials studied, and its behavior was rather similar to glass.<sup>316</sup> There was also the question of surface energies, the original impetus for the work. Such studies were carried out in sapphire, in various kinds of glasses, and in the semi-brittle material, solid sodium chloride.

There were even highly practical applications in proof-testing of brittle solids. Suppose that a structural part made of such a brittle material is to be tested. Generally, failure will arise from the presence of minute surface cracks. If the size of these were known, then the stress intensity factor at the service stress could be calculated, and, with crack-velocity data such as Wiederhorn's, the service life could be inferred. The size of these minute flaws is generally unknown, but an upper limit on the size can be determined by simply, but quickly, loading the item to a load well above the service load. If the item does not break, then the critical stress intensity factor, which is the stress intensity factor for catastrophic fracture, has not been exceeded, and from this the maximum size of the flaw can be calculated. Then, using the crack velocity data, the minimum service life can be determined. Other more sophisticated schemes can be developed.<sup>317</sup>

This work formed the first concerted program in fracture mechanics at the Bureau. It attracted considerable attention in the technical community, and both young and experienced scientists were attracted to joining it. The study of fracture in ceramic materials has been continuously and productively pursued at the Bureau since Wiederhorn's early work, much of it supported by the Office of Naval Research (ONR). Eventually a program in fracture that included theorists and work on the difficult problems of metal fracture was initiated, but it is fair to say that, at the Bureau, the genesis of fracture mechanics research was with Wiederhorn's work on the fracture of glass.

---

<sup>316</sup> S. M. Wiederhorn, "Fracture of Ceramics" in *Mechanical and Thermal Properties of Ceramics: Proceedings of a Symposium Held at Gaithersburg, Maryland, April 1-2, 1968*, J. B. Wachtman, Jr., ed., Natl. Bur. Stand. (U.S.) Special Publication 303; May 1969: 217-241.

<sup>317</sup> A. G. Evans and S. M. Wiederhorn, "Proof Testing of Ceramic Materials—an Analytical Basis for Failure Prediction," *International Journal of Fracture* 10 (1974): 379-392.

## The Investigation of the Point Pleasant Bridge Collapse

Like the Bureau's investigation of the failure of cargo ships during World War II, the investigation of another dramatic structural failure was carried out by the Metallurgy Division.<sup>318</sup>

On the western boundary of West Virginia, at the town of Point Pleasant, U.S. Highway 35 was carried over the Ohio river by a suspension bridge named the Point Pleasant bridge, but more often called the "Silver Bridge" because it was painted with aluminum paint. On December 15, 1967, while the bridge was crowded with afternoon rush-hour traffic, it suddenly collapsed, spilling people and vehicles into the river and onto its banks. Forty-six persons lost their lives. The newly-formed National Transportation Safety Board (NTSB) began an investigation that was to proceed for three years, although the cause of the collapse was known much earlier.<sup>319</sup>

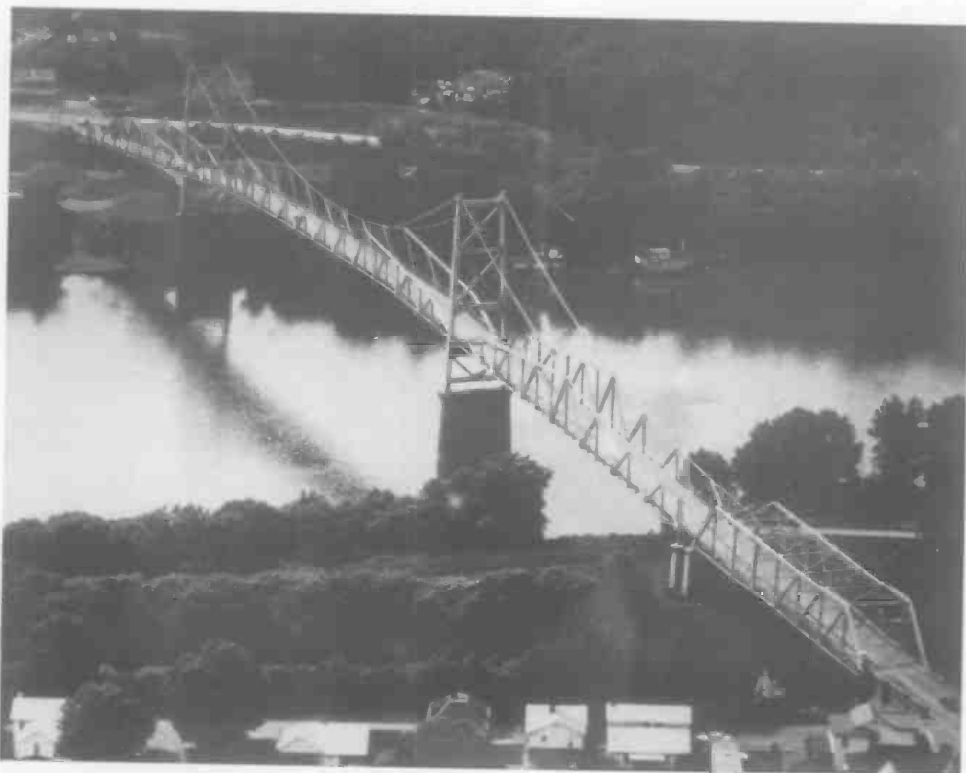

The Point Pleasant Bridge carried U.S. Highway 35 over the Ohio River from Point Pleasant, West Virginia, into Ohio before the bridge collapsed on December 15, 1967. (Courtesy of the West Virginia Department of Highways)

<sup>318</sup> John A. Bennett, "Metallurgical Examination and Mechanical Tests of Material From the Point Pleasant, W. Va. Bridge, Part 1," NBS Report 9981, February 14, 1969; J. A. Bennett and H. Mindlin, "Metallurgical Aspects of the Failure of the Point Pleasant Bridge," *Journal of Testing and Evaluation* 1 (1973): 152-161.

<sup>319</sup> National Transportation Safety Board, "Collapse of U.S. 35 Highway Bridge, Point Pleasant, West Virginia, December 15, 1967," NTSB SS-H-2, October 1968.

Although the bridge was a suspension bridge, its design was unusual in three ways. First, unlike more common suspension bridges in which the suspension members are large cables composed of drawn steel wires, in the Point Pleasant bridge the suspending members were two chains made of pairs of eyebars linked together—completely analogous to a bicycle chain except that the links in the chain were 55 feet long, with shanks 12 inches wide and 2 inches thick, and the eyes in the eyebars were 11.5 inches in diameter. Second, the chains were the top members of a stiffening truss in parts of the main and side spans. Third, the steel used for the eyebars was a relatively new material in the late twenties when the bridge was built. It was a medium carbon steel in the water-quenched and tempered condition. This provided a material of high yield strength, which lowered the construction cost.

Unfortunately, while behaving normally in an ordinary tensile test, the new steel had a low resistance to crack propagation. This was not recognized at the time the bridge was built. In January 1968, the Bureau of Public Roads of the Federal Highway Administration of the Department of Transportation, which was conducting the investigation with the NTSB, requested that the Bureau send a representative to examine the wreckage resulting from the collapse.<sup>320</sup> Hence, John A. Bennett of the Metallurgy Division, a scientist with many years experience in failure analysis, visited the site on January 22 and 23, 1968.

Upon returning, in a state of controlled excitement he reported his findings to the division chief, Elio Passaglia, and his assistant, Harry C. Burnett. He showed photographs of the fracture through one of the eyebars (serial number 330). On one side of the eye, the fracture was perfectly flat and radial, while on the other side there was considerable plastic deformation and tearing. In his report of the examination on January 26, 1968, he wrote:

I observed only one fracture that I consider to be of primary importance in connection with the collapse of the bridge; that is the fracture through the eye of the eybar which I believe bears the serial number 330. . . . I believe that this configuration of the fracture could have been produced only by a progressive cracking of the first side by loads whose maximum value did not cause appreciable plastic deformation of the eye. . . . When this first fracture was completed, the other side was subjected to an excessive load and failed rapidly, but with a fairly ductile tearing fracture. . . . I have been unable to conceive of any way in which this fracture could have occurred after any other failure in the eybar chain. I believe, therefore, that it is almost unquestionably the primary fracture in the collapse.<sup>321</sup>

Bennett's deduction was to prove completely correct, but it took a great deal of laboratory work before the deduction could be proved. While a complete, if not exhaustive, metallurgical examination was carried out,<sup>322</sup> the most crucial examinations were

<sup>320</sup> Bennett, "Metallurgical Examination": 1.

<sup>321</sup> *Ibid.*

<sup>322</sup> J. A. Bennett and M. R. Meyerson, "Metallurgical Examination and Mechanical Tests of Material from the Point Pleasant, W.Va. Bridge, Part 2," NBS Report 9981, February 14, 1969.





Figure 1: Inboard piece of the broken eye from the Point Pleasant Bridge. The north face is shown, and the lower side of the eye is at right.

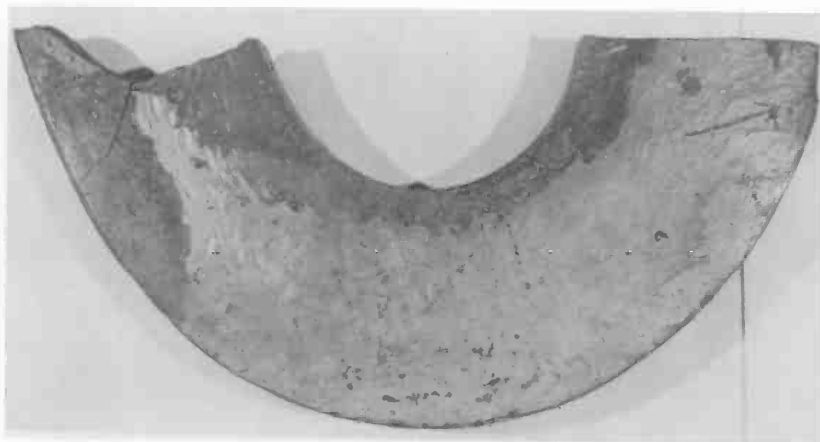

Figure 2: Outboard piece of the broken eye, as received, oriented as in figure 1.

those having to do with the nature of the fracture. Briefly, the fracture surfaces were examined and photographed. The markings indicated that the fracture had started at the surface of the eye hole at a point 0.1 inch from the face of the eye. At this point there was clear-cut evidence of a pre-existing crack which formed the site for the initiation of a crack that proceeded catastrophically from this point across the side of the bar.

The pre-existing crack was clam shell in shape, and only 0.12 inches deep and 0.28 inches long. Finding this crucial, pre-existing crack prompted an extensive search for other cracks. Many were found, all initiating in areas where there was heavy corrosion, suggesting that the mechanism of cracking was stress corrosion.

One of the crucial questions was whether the size of the pre-existing crack was sufficient to cause a brittle fracture. The question could only be answered by fracture mechanics data, and extensive investigations at Battelle Memorial Institute (one of several participants in the investigation), including one full-scale test on an eyebar, led to the conclusion that it was. Thus, the whole failure sequence likely started at this small, pre-existing crack.

The final conclusion was that a combination of factors was responsible for the collapse. These were:

1. The high hardness of the steel made it susceptible to stress corrosion cracking.
2. The close spacing of components in the eye joint made painting impossible, leading to a site where corrosion could take place.
3. The high design load in the eyebar chain resulted in a local stress at the inside of the eye greater than the yield strength of the new steel.
4. The low fracture toughness of the steel caused it to fail catastrophically from a strategically located crack only 0.12 inches deep.

The absence of any one of these would have prevented failure.

The collapse of the Point Pleasant Bridge had important repercussions. It was a case where, using the basic knowledge of materials available at the time of construction, everything was done correctly. But it was not recognized that such a steel could show stress corrosion, and fracture mechanics had not progressed to the point where the disastrous consequences of a  $\frac{1}{8}$  inch crack could be foreseen. It was a strong argument for basic research in materials science and engineering, and it provided strong support for the effectiveness of linear elastic fracture mechanics, which at that time was not as widely accepted as it is now. There were two important repercussions resulting from the collapse. The first was the closing and subsequent removal of a bridge at St. Marys, West Virginia, which was identical to the Silver Bridge. The second repercussion was that the FHWA undertook an investigation of cracks in all highway bridges. The bridges were not in good shape. And partly as a result of this investigation, and partly to reaffirm an activity it had carried out for most of its history, in 1968 the Metallurgy Division announced a program of service to Government agencies entitled Analysis of Material and Structural Failures.

## Atomic Weights and Isotopic Abundances

Atomic weights and isotopic abundances are crucially important in many realms of science.<sup>323</sup> In fundamental-constant work, accurate values are essential to the determination of Avogadro's number, the Faraday, and the gas constant R. Isotopic abundances for lead, argon, strontium, potassium, and a number of other elements are used in geochronology, and a comparison of terrestrial isotopic abundances with those in meteorite material give important clues to the formation of elements in cosmology. A particularly apt illustration, albeit now of limited use, was the relation between the atomic weight of silver, the Faraday, and the definition of the old international ampere, now superseded by the absolute ampere. In modern analytical chemistry, the technique of "isotope dilution mass spectrometry" (IDMS) is becoming a reference method for the determination of the major component in a mixture.<sup>324</sup>

With modern mass spectrometers, the best way of determining the atomic weight of multi-isotope elements is via the relative abundance of its isotopes, and, of course, their atomic masses. Then the atomic weight of the element is obtained as a simple average, which can be scaled to the atomic mass of carbon-12, taken as 12 units. Thus in principle the method is very simple. All that is necessary is to place the element in a mass spectrometer and determine both the masses and the relative abundances of the isotopes. In practice, however, the situation is not that simple. In order for the measurement to be made, the element must be vaporized, ionized, and the atoms counted or otherwise detected after passing through the apparatus. Now the various isotopes of the element do not behave the same way in this process. They will not necessarily evaporate, ionize, or be detected with equal efficiency. In the term of the trade, a "bias" or systematic error can exist.

A legacy of the Manhattan Project, however, provided a means of handling this problem. Nearly pure isotopes of many elements were produced and were made readily available in the project. From these nearly pure isotopes, synthetic mixtures of known composition could be made, and measuring these with the mass spectrometer system could provide a measure of the bias inherent in the measurement process described above. The synthetic mixture provided a means of calibrating the system and procedure. The isotopic abundances (generally expressed as ratios) produced by this laborious but accurate method are called "absolute isotopic abundances." The resulting atomic weights are the most accurate available. It is clear, of course, that samples must come from many different locations in order to check on the geographic variability, and to yield atomic weights that are indeed representative of terrestrial material.

With this capability, in the early sixties the Bureau began a long-term program to determine the atomic weights of various elements by solid-source mass spectrometry. As might be expected, the first element studied was silver. The value for the

---

<sup>323</sup> J. R. De Laeter, P. De Bièvre, and H. S. Peiser, "Isotope Mass Spectrometry in Metrology," *Mass Spectrometry Reviews* 11 (1992): 193-245.

<sup>324</sup> P. De Bièvre, J. R. De Laeter, H. S. Peiser, and W. P. Reed, "Reference Materials by Isotope Ratio Mass Spectrometry," *Mass Spectrometry Reviews* 12 (1993): 143-172.

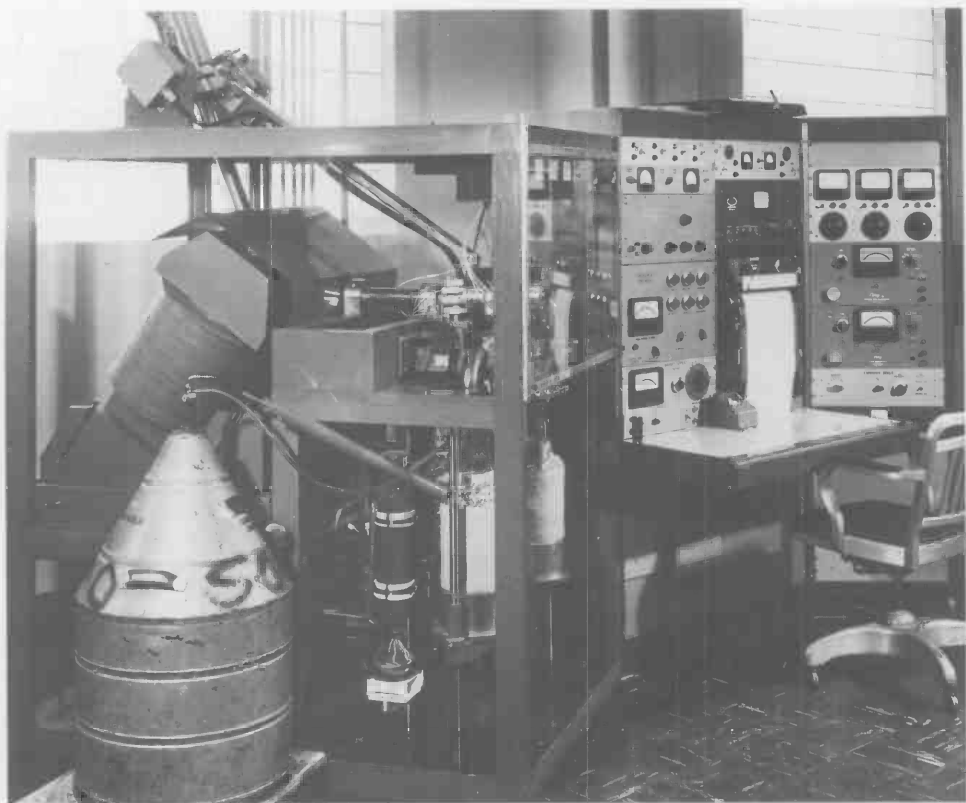

Mass spectrometer used for the determination of the atomic weights of silver, chlorine, bromine, and copper. Part of the large magnet used for deflection of the beam can be seen behind the top of the metallic Dewar at left.

abundance ratio was  $1.07547 \pm 0.0013$  for material from a number of different sources. However, material from Cobalt, Ontario, showed a statistically significant variation which later work did not substantiate.<sup>325</sup> The atomic weight was determined to be  $107.8685 \pm 0.0013$  on the  $C^{12} = 12$  scale.

With this work began a steady stream of other determinations. By 1982, values for twelve elements had been determined.<sup>326</sup> The NBS values were adopted (sometimes

<sup>325</sup> W. R. Shields, D. N. Craig, and V. H. Dibeler, "Absolute Isotopic Abundance Ratio and the Atomic Weight of Silver," *Journal of the American Chemical Society* 82 (1960): 5033-5036. W. R. Shields, E. L. Garner, and V. H. Dibeler, "Absolute Isotopic Abundance of Terrestrial Silver," *Journal of Research of the National Bureau of Standards* 66A (1962): 1-3.

<sup>326</sup> A core group of NBS scientists, which included William R. Shields, Thomas J. Murphy, Ernest L. Garner, Vernon H. Dibeler, Edward Cantazaro and, later, John W. Gramlich, Paul J. Paulsen, I. Lynus Barnes, Larry J. Moore, and Lura P. Dunstan, made determinations for silver, chlorine, copper, bromine, chromium, magnesium, lead, rubidium, rhenium, potassium, thallium, and strontium.

with minor revision) by the Commission on Atomic Weights and Isotopic Abundances, a standing committee of the International Union of Pure and Applied Chemistry.

The Bureau not only carried out the determinations, but it sold samples of some of the materials as SRMs. In 1965 it offered chlorine (as sodium chloride), copper metal, bromine (as sodium bromide), and silver (as silver nitrate). By 1970 it offered nine elements in twelve different SRMs, and by 1988 the numbers had increased to fifteen elements in twenty SRMs. Up to 1987, the Bureau sold certified isotopic-abundance SRMs for uranium, both depleted in  $U^{235}$  and enriched up to 93 percent  $U^{235}$ . In that year the Brunswick Laboratory of the Department of Energy began issuing Certified Reference Materials. These include the plutonium and uranium materials previously issued by the Bureau.

### A Program on Crystal Growth

In 1962, two years before the formation of the Institutes, the Bureau had quite a number of activities, both theoretical and experimental, on the growth and characterization of crystals. The work ranged from the crystal growth of organics (primarily polymers), to inorganic materials and metals. Growth was studied, as appropriate to the system, from solution, from the vapor, and from the melt. Characterization of crystals, or more broadly, materials, was concerned with the study of crystal defects—dislocations, point defects, stacking faults—and their effect on bulk properties. And purification by crystallization was actively pursued. This work, however, was not considered to be a program. Rather it was carried out by individual scientists furthering the mission of their individual organizational units. It was not an unproductive mode of operation.

Aware of the crucial importance of certain highly perfect crystals—and indeed all advanced materials—to military technology, Charles F. Yost, assistant director of materials science for the Advanced Research Projects Agency (ARPA) of the DOD, worked out with Irl C. Schoonover, then Bureau deputy director, “a program for accelerated research in those areas of crystal research that [are] judged to be of critical importance to the entire field of materials research.” A joint NBS/ARPA program on crystal growth and characterization was born, with ARPA funds providing for the expansion of the Bureau’s existing effort.<sup>327</sup>

While at first the program had only two categories of work—crystal growth and crystal characterization—it was expected that the work would develop “theory on the mechanism of crystal growth, experimental techniques for growth and study of crystals, interpretive analysis of observations on crystals examined by diverse methods, and data from the measurement of defect-sensitive properties of crystals.”<sup>328</sup> H. Steffen Peiser was the program coordinator, whose main function—at least in the early days—was to

---

<sup>327</sup> *Research on Crystal Growth and Defect Characterization at the National Bureau of Standards During the Period July to December, 1962*, H. Steffen Peiser, ed., Natl. Bur. Stand. (U.S.) Technical Note 174; March 15, 1963. Similar Technical Notes were issued semi-annually until 1967.

<sup>328</sup> *Ibid.*, 1.



Avery Horton of NBS water-polished a slice from a crystal of ammonium dihydrogen phosphate grown from solution in the NBS-ARPA crystal program. Strains and dislocations introduced into the crystal by abrasive polishing methods were avoided by this technique. After polishing, the crystal was examined by x-ray topography. These crystals were used to determine the inherent imperfections caused by growing variables.

imbue the program participants with the sense of belonging to a unified activity, for in the early days the work was no more than a continuation of what they had been doing. But the extra funds provided by ARPA were very welcome and soon led to an expansion of the effort.

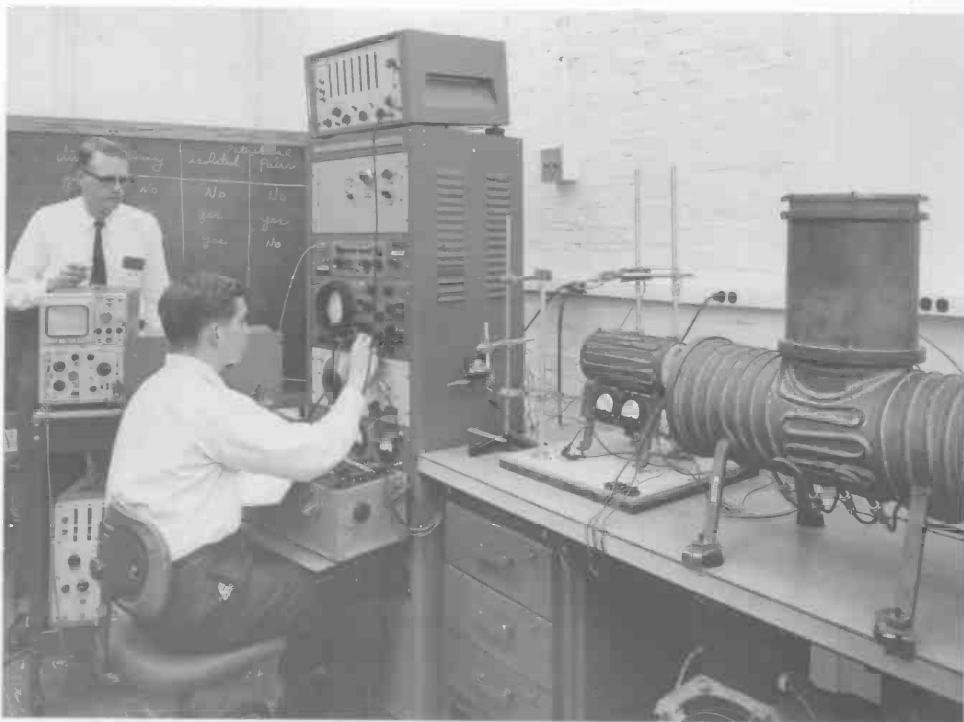

John B. Wachtman, Jr. (left), and Tomas Fridinger (center) made flexural measurements of rutile crystals at NBS. The specimen was held at the desired temperature (20 °C to 600 °C) in the furnace (right) and was oscillated at particular frequencies. The crystal resonated and any changes in the physical properties of the crystal were detected electronically and recorded. From these data, values for such data as internal friction were calculated.

The effort was not small. In July 1962 there were twenty-one projects in crystal growth and twenty-five in crystal characterization, with sixty-one scientists participating.<sup>329</sup> By December 1964, the program had swelled to twenty-five projects in crystal growth, twenty-seven in defect characterization, twenty-three in physical properties of crystalline materials, and sixteen in crystal chemistry. By then there were 181 participants—not all full-time—from the Washington Laboratories, and sixteen from Boulder, mostly from the Cryogenics Division.

With such a massive effort, we can give only a fleeting glimpse of the investigations, and the glimpse is as of mid-1964.<sup>330</sup> Thus, in crystal growth there were projects on the growth of dislocation-free metal crystals from the melt; on the kinetics of growth from the melt of metal crystals; on the theory of dendritic crystallization, which

<sup>329</sup> *Ibid.*, ii, 28-31.

<sup>330</sup> *Research on Crystal Growth and Characterization at the National Bureau of Standards January to June 1964*, Howard F. McMurdie, ed., Natl. Bur. Stand. (U.S.) Technical Note 251; October 19, 1964.

led to powerful work on morphological stability; field emission studies of crystallization; crystal growth by electrodeposition; the growth of large and highly perfect ammonium dihydrogen phosphate crystals from solution; spherulite growth from relatively pure systems; the crystallization of polypropylene from solution, which led to crystals whose habit can be described as a loosely woven place mat; and theoretical studies of whisker growth.

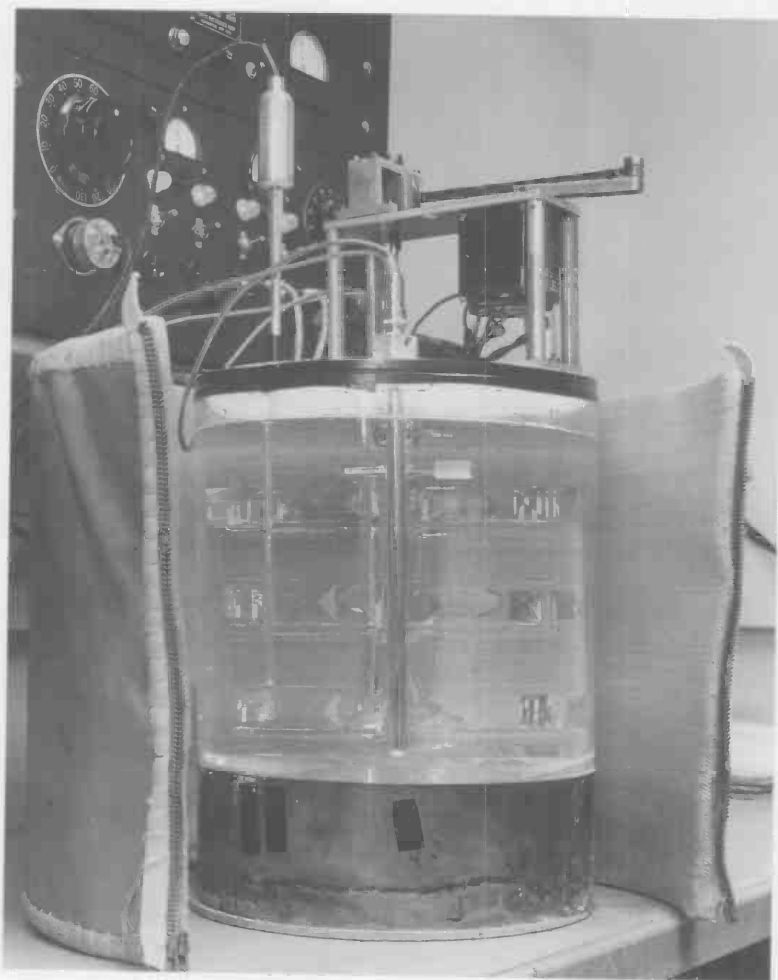

Nearly perfect single crystals of ammonium dihydrogen phosphate were grown from solution in a crystal growing bath. The zippered insulation jacket was removed only during inspection periods. The temperature-control mechanisms (background) and a mixing device (upper right) provided uniform temperature and concentration throughout the solution.



In the study of defects in metal crystals, dislocations and stacking faults received considerable attention. The high-temperature motion of dislocations in aluminum oxide was studied in the electron microscope using a special high-temperature stage. The fundamental electrical properties of commercially important semiconductor crystals were studied with very high precision, and standard measurement methods proposed. The effect of point defects on the dynamic properties of crystals was a continuing project. And the characterization of crystals by x-ray diffraction topography would eventually lead to a re-determination of Avogadro's constant.

In the broad category of physical properties of crystalline materials, which appears to include everything about all solids other than glasses, there were a number of solid-state studies of electronic properties, electron spin resonance and nuclear magnetic resonance studies, soft x-ray studies, and optical properties of some specialized compounds. Another broad field, crystal chemistry, was represented by studies of polymorphism in bismuth trioxide and other systems, the crystal chemistry of mineralized tissue (of great interest to the dental researchers), the radial distribution in glasses, and computer models for amorphous and crystalline phases in simple substances.

This broad and diverse program continued until 1966. At that time ARPA's interest began to change. Feeling it had sufficiently stimulated crystal growth research at the Bureau and elsewhere, it became more concerned with high-temperature and laser materials, and its support dropped accordingly. But much of the crystal growth and characterization research continued, with direct support by the Bureau and a few other agencies.

### **Silicon Resistivity**

In 1960, at the request of the American Society for Testing and Materials (ASTM) Committee F-1 on Materials for Electron Devices and Microelectronics, the then Instrumentation Division formed a program to investigate the problems associated with measurements on silicon wafers to be used in the manufacture of solid-state electronic components.<sup>331</sup> Supported at various times by ARPA, the United States Air Force Cambridge Laboratories, and NASA's Electronic Research Center, and with assistance (through ASTM) by the semiconductor industry, this program was to be technically fruitful, and in many ways it was a prototype for the interaction of the Bureau with other Government agencies and industry.

The most important of the measurements made on silicon wafers is room-temperature resistivity.<sup>332</sup> The reason this property is so important is that it is a measure of the impurity concentration, and this parameter is in turn the most important consideration

---

<sup>331</sup> In 1966 the name of the division was changed to Electronic Instrumentation, and Myron G. Domsitz replaced G. Franklin Montgomery as division chief. In 1969, the name and emphasis were changed to Electronic Technology Division. Domsitz remained chief.

<sup>332</sup> W. Murray Bullis, *Measurement Methods for the Semiconductor Device Industry—A Summary of NBS Activity*, Natl. Bur. Stand. (U.S.) Technical Note 511; December 1969; "Improved Semiconductor Resistivity Measurements," *Technical News Bulletin* 54 (1970): 198-200.

in device design. There were basically two methods in use for the measurement of resistivity: a two-probe method, deemed the more accurate but requiring more work; and a four-probe method which is much easier to carry out. For both methods, the resistivity is calculated from the voltage developed along the path of a known current through the specimen, and the geometry of the specimen. In the two-probe method, a rectangular parallelepiped is cut from the silicon wafer or boule. After polishing, the two ends of the specimen are coated with metal, making them equipotential surfaces, and current is passed from one of these surfaces to the other. Then, on the reasonable assumption that the current density is uniform across all intermediate planes, the resistivity is easily calculated from the dimensions of the specimen and the voltage developed across two planes parallel to the end surfaces, and separated by a known distance. The method is in principle exact and hence yields an accurate measurement, but suffers because the preparation of the rectangular bars is a long and tedious task. It is not useful for routine measurements.

The four-probe method is quite different. In it, four contact points, arranged in a straight line and with accurately known spacing, are pressed onto the silicon surface, and a known current is passed between the exterior probes. Voltage is measured between the two interior probes. No special cutting of a specimen is necessary, only the preparation of a polished surface. The problem here is to know the current distribution. The solution for a semi-infinite space is well known and results in a particularly simple formula for the resistivity. For finite-size circular specimens, correction factors to this formula to account for finite diameter and thickness and the location of the probe with respect to the center of the specimen had to be developed. The problem was solved, but not in closed form, so that tables had to be published.<sup>333</sup> Attesting to the interest in the topic, more than 1500 copies of the report were requested by industry. Also calculated were four-probe correction factors for the use of the four-probe method on rectangular bars.<sup>334</sup> The calculation required machine computation, but it led the way to a direct comparison between two- and four-probe methods on the same specimen.

Besides these results, a number of other factors needed investigation. These were the probe force, probe material, surface preparation, and probe wander—i.e., movement of the probe points from their expected positions. And, of course, the effect of temperature had to be considered. It was not trivial, for experiments showed that at room temperature, the temperature coefficient was about 1 percent per Celsius degree. Eventually, an electrical measuring circuit of proper input impedance and good accuracy was developed.

---

<sup>333</sup> Lydon J. Swartzendruber, *Correction Factor Tables for Four-Point Probe Resistivity Measurements on Thin, Circular Semiconductor Samples*, Natl. Bur. Stand. (U.S.) Technical Note 199; April 1964.

<sup>334</sup> Lydon J. Swartzendruber, *Calculations for Comparing Two-Point and Four-Point Probe Resistivity Measurements on Rectangular Bar Shaped Semiconductor Samples*, Natl. Bur. Stand. (U.S.) Technical Note 241; June 1, 1964.

While a standard for publication by ASTM was in preparation, several round-robin tests on the new techniques were run. Experienced laboratories achieved a standard deviation of somewhat less than 1 percent, five times better than was achieved with a 1964 standard, and sufficiently good for transactions at the buyer-seller material interface. Inexperienced laboratories, however, had considerable difficulty, caused primarily by unsatisfactory electrical measuring equipment.

One part of the planned program did not come to pass. It had been planned from the beginning that the Bureau would offer silicon SRMs certified for resistivity to be used in calibrating probes. However, a study showed that the available material was not sufficiently uniform "to provide the accuracy and reproducibility required by industry."<sup>335</sup> But the whole project was a fine example of cooperation between the Federal Government, in the form of the Bureau and interested other agencies, and the private sector in the form of producers and users of circuit-grade silicon, and a voluntary standards organization. By this cooperation, and largely because of the Bureau's work, an important industrial measurement in the Nation's National Measurement System had been substantially improved.

### Evaluating Nuclear Radiation Detectors

While work was going on to develop new measurement methods for the resistivity of silicon, the Electronic Technology Division, with support from the Division of Biology and Medicine of the Atomic Energy Commission (AEC), entered into a new program on the evaluation of semiconductor detectors for gamma radiation.<sup>336</sup> The problem was that while some detectors worked well, others, ostensibly the same, were unsatisfactory. And the only way to determine if a sample of starting material had the properties to yield a good detector was by manufacturing a detector and trying it out. Because of the manner of fabrication, this was a long and tedious process that required 8 to 10 weeks.

These detectors consisted of a relatively thick slab of intrinsic germanium (essentially the same number of electrons and holes) sandwiched between thin layers of *p*-type (current carriers are holes) and *n*-type (current carriers are electrons) material. The detector acts like a "solid-state ionization chamber." In use, a reverse bias is applied to the device and gamma rays reach the intrinsic region creating holes and electrons which flow to the *p*- and *n*-type layers, respectively. The total charge collected is proportional to the energy of the incident photon—when everything works properly.

The reason production took so long was the painstaking manufacturing process. Obtaining "essentially intrinsic" germanium meant the achievement of an unattainable level of purity in the starting material. As a result, it was slightly *p*-type, with a minute

<sup>335</sup> "Improved Semiconductor Resistivity Measurements," *Technical News Bulletin* 54 (September 1970): 198.

<sup>336</sup> A. H. Sher, "Lithium-Ion Drift Mobility in Germanium," *Journal of Applied Physics* 40 (1969): 2600-2607; "Evaluating Ge(Li) Nuclear Radiation Detectors: Cause of Defects Sought," *Technical News Bulletin* 53 (December 1969): 268-269.

amount of boron (which forms holes) added to make it so. Then the holes were filled by adding lithium, which enters the germanium lattice interstitially and is an electron donor. The process is called compensation, with the lithium electron compensating for the hole-forming boron. The lithium was introduced by field-aided diffusion, that is, by applying a very thin layer of lithium to one surface (in the form of a suspension in oil), applying a voltage of up to 1000 volts across the slab, and heating for as long as several weeks. The lithium must diffuse just enough, but not too much, for the device to work properly. The process is called "drifting" and these devices are labelled Ge(Li) detectors. Clearly, this "drifting" or "compensation" step was the most critical step in the fabrication process.

For this reason, Alvin H. Sher undertook to re-determine the mobility of lithium in germanium. Without explaining the process here, he obtained results that were significantly higher at room temperature than two results obtained previously. However, the germanium crystals used in the experiments were specially selected to be free of "impurities that might reduce the lithium mobility."<sup>337</sup> Other samples showed results that were a factor of 100 lower in lithium diffusion at room temperature. Other studies, such as resistivity, photoconductive decay carrier lifetime, and etch pit studies, were inconclusive. The only tenable conclusion was that the scatter in performance of these detectors was caused by variations in the impurity content, which in turn caused differences in the lithium mobility.

The Bureau did not solve the problem of germanium. It did provide six nomographs to "facilitate the fabrication and testing of" these detectors.<sup>338</sup> Two of these nomographs were concerned with processing and four with testing. The parameters identified in the nomographs concerned with processing were (1) time, temperature, applied bias, and drifted depth; and (2) lithium mobility, crystal resistivity, and oxygen concentration. For the other four, the parameters were (3) area, capacitance, and drifted depth for planar detectors; (4) the same parameters for coaxial detectors; (5) total spectral resolution, system noise, and detector resolution; and (6) detector resolution, gamma ray energy, and effective Fano factor.<sup>339</sup> The titles indicate which parameters the Bureau considered to be the critical parameters in the fabrication and testing of Ge(Li) nuclear radiation detectors.

<sup>337</sup> Sher, "Lithium-Ion Drift": 2605.

<sup>338</sup> Alvin H. Sher, *Nomographs for Use in Fabrication and Testing of Ge(Li) Detectors*, Natl. Bur. Stand. (U.S.) Technical Note 537; August 1970.

<sup>339</sup> The Fano factor gives the relationship between the number of pairs produced by the ionizing radiation and the variance of that number. Multiplied by 100 it could be called "% variance." It can be calculated theoretically from models of the fluctuation of the number of pairs produced per event, and thus is a measure of the theoretical accuracy possible in ionization methods of measuring the energy of radiation. U. Fano, "Ionization Yield of Radiations. II. The Fluctuations of the Number of Ions," *Physical Review* 72 (1947): 26-29.

## Building Research and the Performance Concept

One of the principal policies of the Institute for Applied Technology was variously called the "performance concept" or "performance criteria." More commonly known as performance standards, the concept specifies the function an item is to perform, rather than the materials from which it is made and the details of its construction. For example, a performance standard for a wall might enumerate such functions as the load it is to bear, the maximum rate of heat and sound transfer through it, and other such functions. Mention of the material of construction and method of manufacture would not necessarily be made. At the other extreme, existing construction standards were typically based on "narrowly drawn engineering specifications," such as 2×4 studs on 16 inch centers, with 3/4 inch exterior plywood siding, interior dry wall, and so forth. The importance of the concept was that it "provides for maximum expression of creativity and innovation among builders and manufacturers because attention is focused on the function of a particular system rather than on the system itself."<sup>340</sup>

Implementation of the performance concept is not simple. The performance in mind when the item functions is, of course, performance in service. To assess this performance, however, it is necessary to build the item, place it in service, and determine—either objectively by measurements or subjectively—how it performs. Such information is difficult to obtain, and the existence of a performance concept is not necessary to carry it out. It is relatively easy to assess performance in a test, as, for example, the thermal conductivity of a candidate wall construction. However it is hard to relate performance in a test to performance in service. The better the scientific knowledge relating performance to composition and structure, the easier and more valid will be the determination of the relationship between performance in a test to performance in service.

While the concept was applied to all IAT standards when possible, its greatest expression came in building research. James R. Wright, chief of the Building Research Division, in a discussion of the performance concept, recognized a number of sub-categories under the performance concept: Performance Requirement ("a qualitative statement describing a problem for which a solution is sought"); Performance Criteria ("give the set of characteristics that solutions must have"); Performance Specification ("comprehends all of the information in the underlying requirement and criteria"); and finally Performance Standards and Performance Codes.<sup>341</sup>

<sup>340</sup> Annual Report for 1966: 86.

<sup>341</sup> James R. Wright, "Measurement—Key to Performance," in *Performance of Buildings—Concept and Measurement: Proceedings of the 1st Conference in a Series of Conferences on Man and His Shelter Held at Gaithersburg, Maryland, September 23-25, 1968*, W. W. Walton and B. C. Cadoff, eds., Natl. Bur. Stand. (U.S.) Building Science Series 1; 1970: 11-19.

Some of these subcategories were put to the test in a series of investigations on the development of performance criteria and test methods for various building components: sanitary plumbing systems; exterior walls with respect to their air, moisture, and heat transfer, and with respect to their structural properties; and floor coverings.<sup>342</sup> The conclusions reached by Paul R. Achenbach during the course of a study of plumbing fixtures were generally applicable to all the investigations. Tests were, of course, carried out on full-size specimens, and in all cases the "adequate simulation of use conditions is a key ingredient in developing test procedures applicable to widely different materials." He also pointed out that many of the problems were multidisciplinary, and multidisciplinary laboratory efforts were necessary in the development of test methods. Developing performance measures was no easy matter.

More ambitious was the performance testing of a whole housing system.<sup>343</sup> In an investigation carried out for the Department of Housing and Urban Development, the Bureau evaluated the full-scale performance of a low-income housing system planned for construction in Detroit. The system used new concepts developed by Neal Mitchell of Harvard's Graduate School of Design. Using prefabricated, lightweight components, the housing system obtained its stiffness and rigidity by the interaction of its structural elements. This provided a lightweight, easily erected and expandable structure.

The Bureau erected the first floor of one unit in its structures laboratory since the full three stories of the unit exceeded the capacity of the laboratory. Stresses were applied to the first floor to represent those that would be present in the full structure under both normal service and potential ultimate loading conditions, and additional tests were carried out on system components. As part of the work, performance criteria for the evaluation of the structural safety of the design were developed. The work indicated that the design did not sacrifice safety for economy. In view of the significance of the Bureau's findings, the city of Detroit waived code requirements and issued a building permit for the project.

In a similar project, another prefabricated building was erected and evaluated in the Building Research Division environmental test chamber.<sup>344</sup> Prefabricated in Florida and trucked to the Bureau, this building was being developed for use as an advanced-base, relocatable structure by the U.S. Navy, which sponsored the Bureau's work.

<sup>342</sup> Paul R. Achenbach, "Performance Testing of Sanitary Plumbing Fixtures," in *Performance of Buildings*: 65-73; Henry E. Robinson, "Performance Testing of Exterior Walls: Air, Moisture, and Heat Transfer," in *Performance of Buildings*: 75-76; Robert G. Mathey and Thomas W. Reichard, "Performance Testing of Exterior Walls: Structural Properties," in *Performance of Buildings*: 77-84; Winthrop C. Wolfe and William C. Cullen, "Performance Testing of Floor Coverings," in *Performance of Buildings*: 85-92.

<sup>343</sup> Edward O. Pfrang, "Performance Testing of a Low-Cost Housing System," in *Performance of Buildings*: 49-60; Edward O. Pfrang and Felix Y. Yokel, *Structural Performance Evaluation of a Building System*, Natl. Bur. Stand. (U.S.) Building Science Series 25; November 25, 1969; "Performance of Low-Income Housing: Phoenix Project Studied," *Technical News Bulletin* 53 (1969): 84-85.

<sup>344</sup> Annual Report for 1969: 149; "Prefabricated Building Undergoes Evaluation," *Technical News Bulletin* 53 (1969): 154-155.



The first factory-built module constructed for the Department of Housing and Urban Development Operation Breakthrough program was tested and evaluated by the Bureau. The full-scale structure was subjected to racking and floor and wall impact tests.

The building was constructed of panels made of sheet aluminum bonded to a paper honeycomb structure, with the panels set on an I-beam foundation. Loads were applied to the building to simulate snow and wind loads, and other tests measured air leakage and heat loss. With the capability of the chamber to provide ambient exterior temperatures from  $-50^{\circ}\text{F}$  to  $150^{\circ}\text{F}$ , and exterior relative humidities from 10 percent to 90 percent, performance was evaluated over the whole range of environmental conditions anticipated in service. As a result of the tests, the Bureau recommended design changes to improve the thermal and structural performance of these buildings.

### **Disaster Investigation**

We saw in the investigation of the Point Pleasant Bridge collapse how the Bureau was requested to visit the disaster site, and subsequently to participate in an investigation of the cause of the failure. We also saw how the Metallurgy Division reaffirmed its long-standing policy of assisting other agencies in the investigation of material and structural failures. Generally speaking, the work involved in this failure analysis activity, in which a single structure or piece of equipment had failed, was laboratory

work designed to determine the initial cause of the failure—to find the responsible flaw or malfunction. As such, the work was concerned with fractographic investigations, the determination of how well material properties met specifications, and similar activities. The investigation of the accident site—reassembly of pieces, questioning of witnesses, and other such activities—was not part of the Bureau's investigations.

In the period covered by this chapter, the Building Research Division, became involved in a related activity: disaster investigation. Here the concern was—and remains—to determine how different types of structures withstood natural disasters: floods, hurricanes, tornadoes, and earthquakes. The concern was to obtain information which could be used in new building codes to prevent—as far as possible—damage or destruction in such harsh environments. Unlike the failure-analysis investigations, these disaster studies were almost entirely field work, determining first of all the character of the natural phenomenon causing the disaster, and then the response of various structures to it. It was, therefore, not necessarily concerned with the detailed analysis of an individual structure, but rather on the behavior of classes of structures—why some withstood the phenomena and others did not.

As if designed to illustrate the scope of the work, natural disasters of four different types sparked investigations within a few years' time:

- A flood caused extensive damage in Fairbanks, Alaska, in August 1967.<sup>345</sup>
- Hurricane Camille occurred in August 1969.<sup>346</sup>
- A tornado hit Lubbock, Texas, on May 11, 1970.
- An earthquake measuring 6.6 on the Richter scale occurred in the San Fernando area of California on February 9, 1971.

We will illustrate this type of work by briefly describing what the Bureau did in the last two investigations.

In 1970, Lubbock was a city of about 150 000 persons in the Texas Panhandle, 115 miles south of Amarillo.<sup>347</sup> At 9:15 p.m. on May 11, a radar echo was picked up, indicating a tornado ten miles east of the city. About twenty minutes later, another radar echo and visual sighting placed the tornado near the center of the city, from whence, as indicated by subsequent damage, it followed a course north by northeast. At 10 p.m. it passed the Weather Bureau office at the Lubbock airport northeast of the city, where at 10:02 p.m. winds measured 89 mph, and 1.8 in. of rain fell in one hour. The tornado continued on a northeast path and eventually left the city.

<sup>345</sup> Annual Report for 1968: 126.

<sup>346</sup> Annual Report for 1970: 132-133.

<sup>347</sup> N. F. Somes, R. D. Dijkers, and T. H. Boone, *Lubbock Tornado: A Survey of Building Damage in an Urban Area*, Natl. Bur. Stand. (U.S.) Technical Note 558; March 1971.



It was a severe tornado. The death toll was twenty-six, and property loss was estimated at \$200 million, with 460 single-family detached homes destroyed, 489 severely damaged, and 754 sustaining minor damage. In addition, 80 mobile homes were destroyed and 30 were severely damaged. Because such natural disasters provide unparalleled full-scale tests of building construction, the Building and Research Division sent a three-man team (the authors of the cited report) to carry out an investigation. On May 14-16, the team carried out thorough photographic, ground, and helicopter surveys of the damage along the path of the tornado.

The survey found that the "predominant type of building damage . . . was the loss of roof coverings and roof structures," and goes on to detail the differences in the behavior of various kinds of asphalt shingle roofs, clay tile roofs, and metal roofs, where inadequate fastening resulted in large areas of the roof being stripped from its support. In many places complete roof structures were lost, indicating that uplift forces had not been sufficiently considered in design. Other areas investigated were glazing, masonry veneer, flying debris, and mobile homes, where the level of the damage could have been reduced by using over-the-roof ties. The two principal conclusions were that "currently accepted good practice for the design and construction of buildings . . . against wind loads . . . would . . . have greatly reduced the damage observed at Lubbock; and, following the theme of the research program of the division, "research is needed to develop performance criteria with respect to wind loads."

The San Fernando earthquake investigation followed much the same lines.<sup>348</sup> The quake occurred on February 9, 1971, at 6:41 a.m., killing sixty-four and causing \$500 million in damages. Within twenty-four hours, at the request of the White House Office of Emergency Preparedness, four members of the Building and Research Division were at the site, examining homes, schools, hospitals, roads, bridges, public services, and flood control facilities. An abbreviated list of their findings follows:

1. Present procedures used to update design regulations should be evaluated to find more expeditious ways to incorporate new knowledge into design. To put it another way, changes in the building codes had not kept up with increases in knowledge.<sup>349</sup>
2. As a corollary to this observation, the Bureau team recommended that the earthquake hazard evaluation of older structures built under older codes begin immediately.

---

<sup>348</sup> H. S. Lew, E. V. Leyendecker, and R. D. Dikkers, *Engineering Aspects of the 1971 San Fernando Earthquake*, Natl. Bur. Stand. (U.S.) Building Science Series 40; December 1971. A synopsis of this is in "Report on the San Fernando Earthquake," *Technical News Bulletin* 56 (1972): 99-100.

<sup>349</sup> Originally this recommendation read, "An immediate review should be made of the adequacy of present design requirements for seismic design." Such a review began in 1972 under NSF and NBS sponsorship. (Richard N. Wright, memorandum to Elio Passaglia, February 23, 1993. History Project File; Chapter 5; Folder Disasters)

3. Deformation and deflection should be considered along with strength in the design of earthquake-resistant structures. Since it is difficult for a rigid structure to withstand the large displacements imposed on it by the earthquake, design should be flexible enough to accept the imposed large displacements.
4. Hazards created by overhead objects such as ceiling fixtures, emergency lights, suspended ceilings, and similar components should be kept in mind in their design and placement.
5. Walls with large openings, such as required for garages, should be given adequate strength and stiffness.
6. The report also recommended use of flexible joints and automatic cutoff valves to reduce and limit damages to underground water, sewage, and gas lines.
7. Elevator design should be reviewed to improve the likelihood that elevators perform adequately during and after disasters.

From the initiation of the disaster investigation program, the Building Research Division and its successors have kept a team of engineers at the ready to investigate such natural disasters.

### **Experiments in Fire and Smoke**

In 1969 John W. Davis, chairman of the Subcommittee on the National Bureau of Standards of the House Committee on Science and Astronautics, requested that the Bureau prepare a report entitled, "A Review of the Fire Problem and a Proposed Program to Implement the Fire Research and Safety Act of 1968." Authored by John A. Rockett, Alexander F. Robertson, and John F. Christian of the Fire Research Section, the report was printed as a Committee Print in 1970. The authors provided a description of the program under the main headings "Programs Designed Primarily at Reducing Death and Injuries," "Programs Directed at Fire Department Operations," "Fire Losses" (a data collection program), and "Incremental Building Costs." Much of the program was nontechnical, but featured within it were specific projects on fires in buildings and the hazards of smoke. These topics led to a number of technical questions. The Bureau had been at work in these areas even before the enactment of the Fire Research and Safety Act, and a quick summary of three of them follows.

In 1968 the Bureau had an unparalleled opportunity to study the effects of controlled fires in buildings at little cost to itself.<sup>350</sup> Briefly, the Pratt Institute's School of Architecture, with a grant from Housing and Urban Development, built a two-story building with two wings: one of concrete construction and the other of steel frame construction. The two-story structure located in Carteret, New Jersey, was planned to permit technical evaluation of construction materials being considered for use in high-

---

<sup>350</sup> "NBS Studies Fire Safety of Apartment Units," *Technical News Bulletin* 52 (1968): 3-4.



NBS engineers and technicians made last-minute inspections of the instrumentation used to monitor the full-scale burnout of the test building designed by the Pratt Institute. The steel wing (left) and the concrete wing (right) were joined by wooden stairs and a platform.

rise structures. The primary aim of the fire studies was to obtain information on the protection of occupants, and the prevention of fire spread to other apartments and buildings. The Bureau was called in to carry out the fire tests.

In one of the rooms of an apartment, lattice-type cribs constructed of  $2 \times 4$  Douglas fir were placed so as to provide a fuel loading of six pounds per square foot—about average for an apartment. Extensive temperature measurements were provided in the fire room and in adjacent rooms. Windows were open in the fire room but closed in the others. Other measurements included floor deflection, smoke density, and the detection and measurement of toxic fumes. The floor above the fire room was loaded to forty pounds per square foot to represent the structural design load. Fire tests were conducted in both the concrete and steel structures on the ground and second floors.

The tests showed that a small amount of flaming penetrated to the room above, primarily through the development of separations between ceilings and walls, and some smoke and fire penetrated through openings for electrical outlets. Toxic gas measurements were not sufficiently accurate to provide a measure of the hazard from that source. In both the steel and concrete constructions there was no evidence of structural failure, although premature failure of a suspended ceiling did occur. These tests provided valuable experience and data on full-size housing units.

Since the costs of such tests were significant, it was important to study the development of fires in small enclosures where controlled conditions could be used and possibly provide useful information at relatively low cost. Also, it was important to try to find a way to scale the experiments so that fire behavior in large, room-sized enclosures could be predicted.

A series of such experiments was carried out by Daniel Gross and Alexander F. Robertson.<sup>351</sup> Enclosures of three different sizes, but with the same 1:1:2 width:height:length ratios, were constructed of nonflammable structural material. A rectangular opening (a "window") of variable area was made in one end to provide air for the fire. Within the enclosure a crib of sticks of unfinished cellulose-based fiberboard was constructed. The enclosure was placed on a platform scale and, during the burning, measurements were made of the mass burn-up rate as well as changes in the concentration of O<sub>2</sub>, CO, and CO<sub>2</sub>. By adjusting the window opening area, the burning could be controlled from smoldering to fully developed burning.

The importance of the results lay in the development of scaling relationships. During fully developed flaming, the burning rate was approximately constant, and a "ventilation parameter" of the window area multiplied by the square root of the window vertical dimension (to take into account the convective air flow in and out of the window) was developed. A log-log plot of all the burning rates against this parameter produced approximately a single straight line for all the data. However, the data were segregated depending on the nature of the enclosure, so that the data lay in three separate regions on the line. Further, normalizing those data by dividing by the square of the linear dimension ratio produced two nearly straight lines, one for smoldering and another for flaming. All the data fell together on these two lines. The effect of enclosure size had been approximately scaled into the fire behavior. Evident on the plots was a region at high burning rates where the burning rate was rapid and independent of the window area, as if there were no enclosure. An approximate method of scaling fires for room size had been achieved.

The final area of concern was smoke density measurement.<sup>352</sup> In recognition of the critical nature of smoke in causing death and injury in accidental fires, two projects (among others) emphasized the need for better definition and measurement of the properties of smoke aerosols. One HUD-sponsored project sought to provide a convenient and technically sound method for the laboratory measurement of the smoke generated by burning interior finish materials in building fires. This led to the development of a "Smoke Density Chamber" which subsequently became commercially available and

---

<sup>351</sup> D. Gross and A. F. Robertson, "Experimental Fires in Enclosures," in *Tenth Symposium (International) on Combustion* (Pittsburgh, Pa.: The Combustion Institute, 1965): 931-942.

<sup>352</sup> The author is grateful to Daniel Gross for the following paragraph, which he wrote and is used here with minor editorial change.

was adopted as an ASTM Standard.<sup>353</sup> Features of the method included the use of both flaming and nonflaming exposures, the use of an optical density scale for measuring light transmission through the enclosed aerosol, and expressing the results (total smoke generated or instantaneous generation rate) in terms of a nondimensional factor involving the appropriate geometrical parameters: the "specific optical density." This development led to an FAA-sponsored project in which the Smoke Density Chamber was used to measure the smoke generated by materials used on the interior surfaces of passenger aircraft. The project followed shortly after a survivable crash in which half the plane's occupants died from toxic and vision effects of smoke.

## SUMMARY

In the period covered by this chapter, there were important changes in the Bureau and in its role in the Nation. While its traditional concerns had been toward the development of science, technology, and industry, a spate of new legislation gave the Bureau added responsibilities arising from social and consumer equity and safety considerations. These new responsibilities occasionally brought the Bureau to the uncomfortable position of being a quasi-regulatory agency, writing mandatory standards. These new responsibilities had a sufficiently profound impact on NBS that its director, cognizant of the Bureau's traditional functions and not knowing where these new trends would lead, labelled the Bureau an "evolving institution." From the point of view that the Bureau was the Nation's corporate laboratory, and that there was no other institution with the requisite capabilities to shoulder these responsibilities, the addition to the Bureau's duties seems understandable, indeed even natural. However, temporarily, at least, they brought the Bureau to a new but uncomfortable arena.

During this period the Bureau moved to a spacious and beautiful new home where the facilities far surpassed those of its old but beloved (by many of the "old timers") home at Van Ness and Connecticut Avenues in Washington, D.C. In the process it acquired two outstanding new facilities, the LINAC and a nuclear reactor, along with a great deal of modern equipment. With the infusion since Condon's days—and continued by Astin—of the thrust toward basic research, and of scientists conversant with modern methods, the new facilities made the Bureau a world-class scientific institution in every sense of the phrase.

The end of the period marked a historical turning point in the Bureau's existence. In 1969, Allen V. Astin, the Bureau's director for seventeen years, retired. Except for his Director of Administration Robert S. Walleigh, Astin was the last person in an upper management position who had been at the Bureau in prewar days. The leadership of

---

<sup>353</sup> D. Gross, J. J. Loftus, and A. F. Robertson, "Method for Measuring Smoke From Burning Materials" in *Symposium on Fire Test Methods—Restraint and Smoke 1966*, American Society for Testing and Materials (ASTM) Special Technical Publication 422; 1967: 166-204; *Standard Test Method for the Specific Optical Density of Smoke Generated by Solid Materials*, American Society for Testing and Materials (ASTM) Standard E 662.

the Bureau was entrusted to a new cadre of vigorous young leaders, carefully assembled and nurtured since the late forties and early fifties. But the Bureau never broke with its past. The new leadership was too aware of its history and tradition to break away from them summarily. Rather, they built on those traditions following the demands of the times and did not weaken the institution.

As it did in many other institutions, the increasing importance of relevance forced changes on the Bureau. Beginning with Planning, Programming, and Budgeting, the new demands for justification of old and new programs forced upon the Bureau new activities and structures. This gave rise to the Office of Program Planning and Evaluation, which began haltingly and in a small way, but exercised an increasingly profound effect on Bureau management.

Through the whole period the technical work flourished. From the measurement of laser frequencies to the Josephson effect; from fracture mechanics to critical phenomena; from disaster investigations to electron scattering by nuclei; from clinical SRMs to bridge failures; from superconducting semiconductors to new radiometric standards; from the resistivity of silicon to performance standards for buildings, the technical work was sound, interesting, and to the point. It further enhanced the Bureau's reputation.

This page intentionally left blank

# APPENDIX A

## TABLES

<b>Table 1</b> <b>GNP and R &amp; D EXPENDITURES</b> Billions of Dollars						
Year	GNP	Total National R & D	Total Federal R & D	Federal In House R & D	Federal to Industry R & D	Industry In House R & D
1953	364.6	5.124	2.753	1.010	1.430	2.245
1960	503.7	13.523	8.738	1.726	6.081	4.516
% average annual growth	5.45	23.42	31.06	10.13	46.46	14.45
GNP figures from <i>Historical Statistics of the United States: Colonial Times to 1970. Part 1</i> (Washington, D.C.: Bureau of the Census, 1975): 224 R & D expenditures from <i>National Pattern of Science and Technology Resources: 1987</i> (Washington, D.C.: National Science Foundation, 1988) Table B-1, p. 38; Table B-5, p. 46.						

<b>Table 2</b> <b>GNP and R &amp; D EXPENDITURES</b> Billions of Dollars							
Year	GNP	Total National R & D	Total Federal R & D	Federal In House R & D	Federal National Basic Research	Total Federal Basic Research	Federal In House Basic Research
1957	441.1	9.912	6.119	1.220	0.857	0.408	0.122
1964	632.4	19.412	12.553	2.838	2.559	1.595	0.364
% average annual growth	6.20	13.41	15.02	18.95	28.37	41.56	28.34
<i>Historical Statistics of the United States: Colonial Times to 1970. Part 1 and 2</i> (Washington, D.C.: Bureau of the Census, 1975): 224, 965.							



Year	NBS Appropriations			Non-Appropriated Funds <sup>3</sup>	Total Funds <sup>4</sup>	
	RTS Funds <sup>1</sup>		Other Funds <sup>2</sup>		Current	Constant
	Current	Constant				
1961	19.58	27.80	0.0	19.26	38.84	55.14
1962	23.36	32.75	0.40	21.40	45.16	63.31
1963	27.78	38.49	0.71	20.90	49.39	68.44
1964	28.12	38.39	1.89	26.03	56.04	76.51
1965	31.76	42.54	1.03	32.88	65.67	87.96
1966	28.66	37.33	0.94	23.80	53.40	69.55
1967	30.77	38.84	0.36	27.13	58.26	73.53
1968	32.28	39.03	0.58	28.43	61.49	74.11
1969	36.10	41.69	0.94	29.03	66.07	76.30
1970	39.80	43.64	1.02	33.44	74.26	81.43

<sup>1</sup> Research and Technical Services (RTS) funds.

<sup>2</sup> Includes Office of Technical Services, Civilian Industrial Technology, and Special Foreign Currency funds.

<sup>3</sup> Reimbursable funds from consultative, advisory, administrative and technical services; research and development programs supported by other Federal agencies or nongovernmental sources; the performance of various tests and calibrations, and the manufacture and sale of standard reference materials for other Government agencies and the public; and the sale of technical documents to the public.

<sup>4</sup> Does not include the construction and facilities program.

From the NBS Annual Reports for the respective years. Constant amounts are based on 1972 dollars using the GDP deflator.

Year	Full-Time Permanent Staff	Other Staff <sup>1</sup>	Total Paid Staff	Research Associates and Guest Workers	Total NBS Staff
1961	3273	646	3919	305	4224
1962	3477	539	4016	169	4185
1963	3518	642	4160	197	4357
1964	3905	475	4380	177	4557
1965	4002	592	4594	199	4793
1966	3569	441	4010	116	4126
1967	3612 <sup>(2)</sup>	386	3998	199	4197
1968	3519 <sup>(2)</sup>	353	3872	147	4019
1969	3433 <sup>(2)</sup>	570	4003	150	4153
1970	3366	687	4053	131	4184

<sup>1</sup> Summer, Post Doctoral Research Fellows, Part-Time, Intermittent, and Temporary.

<sup>2</sup> Post Doctoral Research Fellows included as FTPS.

From the NBS Annual Reports for the respective years.

---

## APPENDIX B

---

### ACRONYMS DICTIONARY

AACC	American Association of Clinical Chemistry
ACS	American Chemical Society
ADP	Automatic Data Processing
AEC	Atomic Energy Commission
AID	Agency for International Development
AIME	American Institute of Mining, Metallurgical, and Petroleum Engineers
AIP	American Institute of Physics
ANSI	American National Standards Institute
ARIB	Asphalt Roofing Industry Bureau
ARPA	Advanced Research Projects Agency
ASA	American Standards Association
ASCI	American Standard Code for Information Interchange
ASSS	American-Soviet Science Society
ASTM	American Society for Testing and Materials
BBB	Better Business Bureau
BIPM	International Bureau of Weights and Measures (Bureau International des Poids et Mesures)
BOB	Bureau of the Budget
BSA	Board of Standards and Appeals, New York City
BuAer	Bureau of Aeronautics, U.S. Navy
CAP	College of American Pathologists
CCC	Commodity Credit Corporation
CCIR	International Radio Consultative Committee (Comité Consultatif International des Radiocommunications)
CCIT	International Telegraph and Telephone Consultative Committee (Comité Consultatif International Telegraphique et Telephonique)
CCST	Center for Computer Sciences and Technology
CCT	Consultative Committee on Thermometry
CGPM	General Conference for Weights and Measures (Conférence Générale des Poids et Mesures)
CIPM	International Committee for Weights and Measures (Comité International des Poids et Mesures)
CIT	Civilian Industrial Technology
CRM	Certified Reference Material
CRPL	Central Radio Propagation Laboratory
CSC	Civil Service Commission
DOC	Department of Commerce
DOD	Department of Defense
DOT	Department of Transportation
EEO	Equal Employment Opportunity
ESSA	Environmental Science Services Administration
FAA	Federal Aviation Agency
FBI	Federal Bureau of Investigation
FCC	Face Centered Cubic
FCST	Federal Council for Science and Technology
FHWA	Federal Highway Administration
FIPS	Federal Information Processing Standards
FIPS PUBS	Federal Information Processing Standards Publications

FOSDIC	Film Optical Scanning Device for Input to Computers
FTC	Federal Trade Commission
GR-S	Government Rubber-Styrene
GSA	General Services Administration
HHFA	Housing and Home Finance Agency
HUAC	House Committee on Un-American Activities
HUD	Department of Housing and Urban Development
IAT	Institute for Applied Technology
IAU	International Astronomical Union
IBS	Institute for Basic Standards
ICBM	Intercontinental Ballistic Missile
ICC	Interstate Commerce Commission
ICSU	International Conference of Scientific Unions
IDA	Institute for Defense Analysis
IDMS	Isotope Dilution Mass Spectrometry
IGY	International Geophysical Year
IMR	Institute for Materials Research
INA	Institute for Numerical Analysis
IPTS	International Practical Temperature Scale
IQSY	International Year of the Quiet Sun
IRPL	Interservice Radio Propagation Laboratory
ISO	International Standards Organization
JILA	Joint Institute for Laboratory Astrophysics
JPCRD	<i>Journal of Physical and Chemical Reference Data</i>
LORAN	Long Range Navigation
MAP	Measurement Assurance Program
MDE	Modular Design of Electronics
MIT	Massachusetts Institute of Technology
MPE	Mechanized Production of Electronics
NACA	National Advisory Committee for Aeronautics
NAE	National Academy of Engineering
NAML	National Applied Mathematics Laboratories
NAS	National Academy of Sciences
NASA	National Aeronautics and Space Administration
NATO	North Atlantic Treaty Organization
NBBB	National Better Business Bureau
NBS	National Bureau of Standards
NBSR	National Bureau of Standards Reactor
NCASF	National Council of American-Soviet Friendship
NCSL	National Conference of Standards Laboratories
NDRC	National Defense Research Committee
NHSB	National Highway Safety Bureau
NIC	National Inventors Council
NIH	National Institutes of Health
NIPS	National Institutes for Physical Sciences
NIST	National Institute of Standards and Technology
NOL	Naval Ordnance Laboratory

NRC	National Research Council
NRL	Naval Research Laboratory
NSF	National Science Foundation
NSRDS	National Standard Reference Data System
NTIS	National Technical Information System
NTSB	National Transportation Safety Bureau
OBBS	Oakland Better Business Bureau
ODM	Office of Defense Mobilization
OII	Office of Invention and Innovation
OMB	Office of Management and Budget
ONR	Office of Naval Research
OSRD	Office of Scientific Research and Development
OSRD	Office of Standard Reference Data
OSRM	Office of Standard Reference Materials
OST	Office of Science and Technology
OSWM	Office of Standard Weights and Measures
OTS	Office of Technical Services
OVSR	Office of Vehicle Systems Research
OWM	Office of Weights and Measures
PBS	Public Buildings Service
POD	Post Office Department
PPB	Planning-Programming-Budgeting
PSAC	President's Science Advisory Committee
PTB	Physikalisch-Technische Bundesanstalt
PTR	Physikalisch-Technische Reichsanstalt
RM	Research Material
RTS	Research and Technical Services
SAE	Society of Automotive Engineers
SCLC	Southern Christian Leadership Conference
SCOOP	Scientific Computation of Optimum Programs
SEAC	Standards Eastern Automatic Computer
SI	International System of Units ( <i>Système International d'Unités</i> )
SLAC	Stanford Linear Accelerator Center
SRM	Standard Reference Material
SSCSB	Senate Select Committee on Small Business
SSS	Selective Service System (SSS)
SURF	Synchrotron Ultra-Violet Radiation Facility
SWAC	Standards Western Automatic Computer
TAD	Technical Analysis Division
UN	United Nations
USASCII	USA Standard Code for Information Interchange
UT	Universal Time

This page intentionally left blank

---

## APPENDIX C

---

### LEGISLATION RELATING TO THE ORGANIZATION, FUNCTIONS, AND ACTIVITIES OF THE NATIONAL BUREAU OF STANDARDS

July 12, 1894, 28 Stat. 101 (Public Law 105—53d Congress, 2d session)

CHAP. 131.—An Act To define and establish the units of electrical measure.

*Be it enacted by the Senate and House of Representatives of the United States of America in Congress assembled,* That from and after the passage of this Act the legal units of electrical measure in the united States shall be as follows:

First. The unit of resistance shall be what is known as the international ohm, which is substantially equal to one thousand million units of resistance of the centimeter-gram-second system of electro-magnetic units, and is represented by the resistance offered to an unvarying electric current by a column of mercury at the temperature of melting ice fourteen and four thousand five hundred and twenty-one ten-thousandths grams in mass, of a constant cross-sectional area, and of the length of one hundred and six and three-tenths centimeters.

Second. The unit of current shall be what is known as the international ampere, which is one-tenth of the unit of current of the centimeter-gram-second system of electro-magnetic units, and is the practical equivalent of the unvarying current, which, when passed through a solution of nitrate of silver in water in accordance with standard specifications, deposits silver at the rate of one thousand one hundred and eighteen millionths of a gram per second.

Third. The unit of electro-motive force shall be what is known as the international volt, which is the electro-motive force that, steadily applied to a conductor whose resistance is one international ohm, will produce a current of an international ampere, and is practically equivalent to one thousand fourteen hundred and thirty-fourths of the electro-motive force between the poles or electrodes of the voltaic cell known as Clark's cell, at a temperature of fifteen degrees centigrade, and prepared in the manner described in the standard specification.

Fourth. The unit of quantity shall be what is known as the international coulomb, which is the quantity of electricity transferred by a current of one international ampere in one second.

Fifth. The unit of capacity shall be what is known as the international farad, which is the capacity of a condenser charged to a potential of one international volt by one international coulomb of electricity.

Sixth. The unit of work shall be the Joule, which is equal to ten million units of work in the centimeter-gram-second system, and which is practically equivalent to the energy expended in one second by an international ampere in an international ohm.

Seventh. The unit of power shall be the Watt, which is equal to ten million units of power in the centimeter-gram-second system, and which is practically equivalent to the work done at the rate of one Joule per second.

Eighth. The unit of induction shall be the Henry, which is the induction in a circuit when the electro-motive force induced in this circuit is one international volt while the inducing current varies at the rate of one Ampere per second.

SEC. 2. That it shall be the duty of the National Academy of Sciences to prescribe and publish, as soon as possible after the passage of this Act, such specifications of details as shall be necessary for the practical application of the definitions of the ampere and volt hereinbefore given, and such specifications shall be the standard specifications herein mentioned.

Approved, July 12, 1894.

\* \* \* \* \*

March 3, 1901, 31 Stat. 1449 (Public Law 177—56th Congress, 2d session)

The first organic act for the National Bureau of Standards.

CHAP. 872.—An Act To establish the National Bureau of Standards.

*Be it enacted by the Senate and House of Representatives of the United States of America in Congress assembled,* That the Office of Standard Weights and Measures shall hereafter be known as the National Bureau of Standards.

SEC. 2. That the functions of the bureau shall consist in the custody of the standards; the comparison of the standards used in scientific investigations, engineering, manufacturing, commerce, and educational institutions with the standards adopted or recognized by the Government; the construction, when necessary, of standards, their multiples and subdivisions; the testing and calibration of standard measuring apparatus; the solution of problems which arise in connection with standards; the determination of physical constants and the properties of materials, when such data are of great importance to scientific or manufacturing interests and are not to be obtained of sufficient accuracy elsewhere.

SEC. 3. That the bureau shall exercise its functions for the Government of the United States; for any State or municipal government within the United States; or for any scientific society, educational institution, firm, corporation, or individual within the United States engaged in manufacturing or other pursuits requiring the use of standards or standard measuring instruments. All requests for the services of the bureau shall be made in accordance with the rules and regulations herein established.

SEC. 4. That the officers and employees of the bureau shall consist of a director, at an annual salary of five thousand dollars; one physicist, at an annual salary of three thousand five hundred dollars; one chemist, at an annual salary of three thousand five hundred dollars; two assistant physicists or chemists, each at an annual salary of two thousand two hundred dollars; one laboratory assistant, at an annual salary of one thousand four hundred dollars; one laboratory assistant, at an annual salary of one thousand two hundred dollars; one secretary, at an annual salary of two thousand dollars; one clerk, at an annual salary of one thousand two hundred dollars; one messenger, at an annual salary of seven hundred and twenty dollars; one engineer, at an annual salary of one thousand five hundred dollars; one mechanician, at an annual salary of one thousand four hundred dollars; one watchman, at an annual salary of seven hundred and twenty dollars, and one laborer, at an annual salary of six hundred dollars.

SEC. 5. That the director shall be appointed by the President, by and with the advice and consent of the Senate. He shall have the general supervision of the bureau, its equipment, and the exercise of its functions. He shall make an annual report to the Secretary of the Treasury, including an abstract of the work done during the year and a financial statement. He may issue, when necessary, bulletins for public distribution, containing such information as may be of value to the public or facilitate the bureau in the exercise of its functions.

SEC. 6. That the officers and employees provided for by this Act, except the director, shall be appointed by the Secretary of the Treasury, at such time as their respective services may become necessary.

SEC. 7. That the following sums of money are hereby appropriated: For the payment of salaries provided for by the Act, the sum of twenty-seven thousand one hundred and forty dollars, or so much thereof as may be necessary; toward the erection of a suitable laboratory, of fireproof construction, for the use and occupation of said bureau, including all permanent fixtures, such as plumbing, piping, wiring, heating, lighting, and ventilation, the entire cost of which shall not exceed the sum of two hundred and fifty thousand dollars, one hundred thousand dollars; for equipment of said laboratory, the sum of ten thousand dollars; for a site for said laboratory, to be approved by the visiting committee hereinafter provided for and purchased by the Secretary of the Treasury, the sum of twenty-five thousand dollars, or so much thereof as may be necessary; for the payment of the general expenses of said bureau, including books and periodicals, furniture, office expenses, stationery and printing, heating and lighting, expenses of the visiting committee, and contingencies of all kinds, the sum of five thousand dollars, or so much thereof as may be necessary, to be expended under the supervision of the Secretary of the Treasury.

SEC. 8. That for all comparisons, calibrations, tests, or investigations, except those performed for the Government of the United States or State governments within the United States, a reasonable fee shall be charged, according to a schedule submitted by the director and approved by the Secretary of the Treasury.

SEC. 9. That the Secretary of the Treasury shall, from time to time, make regulations regarding the payment of fees, the limits of tolerance to be attained in standards submitted for verification, the sealing of standards, the disbursement and receipt of moneys, and such other matters as he may deem necessary for carrying this Act into effect.

SEC. 10. That there shall be a visiting committee of five members, to be appointed by the Secretary of the Treasury, to consist of men prominent in the various interests involved, and not in the employ of the Government. This committee shall visit the bureau at least once a year, and report to the Secretary of the Treasury upon the efficiency of its scientific work and the condition of its equipment. The members of this committee shall serve without compensation, but shall be paid the actual expenses incurred in attending its meetings. The period of service of the members of the original committee shall be so arranged that one member shall retire each year, and the appointments thereafter to be for a period of five years. Appointments made to fill vacancies occurring other than in the regular manner are to be made for the remainder of the period in which the vacancy exists.

Approved, March 3, 1901.

\* \* \* \* \*

May 20, 1918, 40 Stat 556 (Public Law 152—65th Congress, 2d session) "Overman Act."

First official interagency transfer of funds to the Bureau of Standards. The work was done in support of military agencies during World War I.

CHAP. 78.—An Act Authorizing the President to coordinate or consolidate executive bureaus, agencies, and offices, and for other purposes, in the interest of economy and the more efficient concentration of the Government.

*Be it enacted by the Senate and House of Representatives of the United States of America in Congress assembled*, That for the national security and defense, for the successful prosecution of the war, for the support and maintenance of the Army and Navy, for the better utilization of resources and industries, and for the more effective exercise and more efficient administration by the President of his powers as Commander in Chief of the land and naval forces the President is hereby authorized to make such redistribution of functions among executive agencies as he may deem necessary, including any functions, duties, and powers hitherto by law conferred upon any executive department, commission, bureau, agency, office, or officer, in such manner as in his judgment shall seem best fitted to carry out the purposes of this Act, and to this end is authorized to make such regulations and to issue such orders as he may deem necessary, which regulations and orders shall be in writing and shall be filed with the head of the department affected and constitute a public record: *Provided*, That the Act shall remain in force during the continuance of the present war and for six months after the termination of the war by the proclamation of the treaty of peace, or at such earlier time as the President may designate: *Provided further*, That the termination of this Act shall not affect any act done or any right or obligation accruing or accrued pursuant to the Act and during the time that this Act is in force: *Provided further*, That the authority by this Act granted shall be exercised only in matters relating to the conduct of the present war.

SEC. 2. That in carrying out the purposes of this Act the President is authorized to utilize, coordinate, or consolidate any executive or administrative commissions, bureaus, agencies, offices, or officers now existing by law, to transfer any duties or powers from one existing department, commission, bureau, agency, office, or officer to another, to transfer the personnel thereof or any part of it either by detail or assignment, together with the whole or any part of the records and public property belonging thereto.

\* \* \* \* \*



May 29, 1920, 41 Stat 681 (Public Law 231—66th Congress, 2d session)

Beginning of transferred funds to the Bureau of Standards as authorized in appropriations legislation.

CHAP. 214.—An Act Making appropriations for the legislative, executive, and judicial expenses of the Government for the fiscal year ending June 30, 1921, and for other purposes.

During the fiscal year 1921, the head of any department or independent establishment of the Government having funds available for scientific investigations and requiring cooperative work by the Bureau of Standards on scientific investigations within the scope of the functions of that Bureau, and which it is unable to perform within the limits of its appropriations, may, with the approval of the Secretary of Commerce, transfer to the Bureau of Standards such sums as may be necessary to carry on such investigations. The Secretary of the Treasury shall transfer on the books of the Treasury Department any sums which may be authorized hereunder and such amounts shall be placed to the credit of the Bureau of Standards for the performance of work for the department or establishment from which the transfer is made. (41 Stat. 683)

\* \* \* \* \*

May 14, 1930, 46 Stat. 327 (Public Law 219—71st Congress, 2d session)

CHAP. 275.—An Act Authorizing the establishment of a national hydraulic laboratory in the Bureau of Standards of the Department of Commerce and the construction of a building therefor.

*Be it enacted by the Senate and House of Representatives of the United States of America in Congress assembled,* That there is hereby authorized to be established in the Bureau of Standards of the Department of Commerce a national hydraulic laboratory for the determination of fundamental data useful in hydraulic research and engineering, including laboratory research relating to the behavior and control of river and harbor waters, the study of hydraulic structures and water flow, and the development and testing of hydraulic instruments and accessories: *Provided,* That no test, study, or other work on a problem or problems connected with a project the prosecution of which is under the jurisdiction of any department or independent agency of the government shall be undertaken in the laboratory herein authorized until a written request to do such work is submitted to the Director of the Bureau of Standards by the head of the department or independent agency charged with the execution of such project: *And provided further,* That any State or political subdivision thereof may obtain a test, study, or other work on a problem connected with a project the prosecution of which is under the jurisdiction of such State or political subdivision thereof.

SEC. 2. There is hereby authorized to be appropriated, out of any money in the Treasury not otherwise appropriated, not to exceed \$350,000, to be expended by the Secretary of Commerce for the construction and installation upon the present site of the Bureau of Standards in the District of Columbia of a suitable hydraulic laboratory building and such equipment, utilities, and appurtenances thereto as may be necessary.

Approved, May 14, 1930.

\* \* \* \* \*

June 30, 1932, 47 Stat. 382 (Public Law 212—72d Congress, 1st session) "Economy Act of 1932."

SEC. 312.—An amendment to section 8 of the Act establishing the National Bureau of Standards authorized payment of fees, except for other Federal agencies, for Bureau of Standards tests and calibrations.

SEC. 601.—The policy of transferred funds was restated and made general throughout the Federal Government.

[CHAPTER 314]

#### AN ACT

Making appropriations for the Legislative Branch of the Government for the fiscal year ending June 30, 1933, and for other purposes.

SEC. 312. Section 8 of the Act entitled "An Act to establish the National Bureau of Standards", approved March 3, 1901, as amended and supplemented [U.S.C., title 15, sec. 276], is amended to read as follows:

"SEC. 8. For all comparisons, calibrations, tests, or investigations, performed by the National Bureau of Standards under the provisions of this Act, as amended and supplemented, except those performed for the Government of the United States or State governments within the United States, a fee sufficient in each case to compensate the National Bureau of Standards for the entire cost of the services rendered shall be charged, according to a schedule prepared by the Director of the National Bureau of Standards and approved by the Secretary of Commerce. All moneys received from such sources shall be paid into the Treasury to the credit of miscellaneous receipts." (47 Stat. 410)

.....

SEC. 601. Section 7 of the Act entitled "An Act making appropriations for fortifications and other works of defense, for the armament thereof, and for the procurement of heavy ordnance for trial and service, for the fiscal year ending June 30, 1921, and for other purposes", approved May 21, 1920 [U.S.C., title 31, sec. 686], is amended to read as follows:

"SEC. 7. (a) Any executive department or independent establishment of the Government, or any bureau or office thereof, if funds are available therefor and if it is determined by the head of such executive department, establishment, bureau, or office to be in the interest of the Government so to do, may place orders with any other such department, establishment, bureau, or office for materials, supplies, equipment, work, or services of any kind that such requisitioned Federal agency may be in a position to supply or equipped to render, and shall pay promptly by check to such Federal agency as may be requisitioned, upon its written request, either in advance or upon the furnishing or performance thereof, all or part of the estimated or actual cost thereof, as determined by such department, establishment, bureau, or office as may be requisitioned; but proper adjustments on the basis of the actual cost of the materials, supplies, or equipment furnished, or work or services performed, paid for in advance, shall be made as may be agreed upon by the departments, establishments, bureaus, or offices concerned: *Provided, however,* That if such work or services can be as conveniently or more cheaply performed by private agencies such work shall be let by competitive bids to such private agencies. Bills rendered, or requests for advance payments made, pursuant to any such order, shall not be subject to audit or certification in advance of payment. (47 Stat. 417)

\* \* \* \* \*

August 1, 1947, 61 Stat. 715 (Public Law 313—80th Congress, 1st session)

From time to time amendments to this act extended the authority to other agencies, revised the number of positions allotted, and the salary range. In 1965, NBS had twelve appointees under this law.

[CHAPTER 433]

#### AN ACT

To authorize the creation of additional positions in the professional and scientific service in the War and Navy Departments.

*Be it enacted by the Senate and House of Representatives of the United States of America in Congress assembled,* That the Secretary of War is authorized to establish and fix the compensation for, within the War Department, not more than thirty positions, and the Secretary of the Navy is authorized to establish and fix the compensation for, within the Naval establishment, not more than fifteen positions in the professional and scientific service, each such position being established to effectuate those research and development functions, relating to the national defense, military and naval medicine, and any and all other activities of the War Department or Naval Establishment which require the services of specially qualified scientific or professional personnel: *Provided,* That the rates of compensation for positions established pursuant to the provisions of this Act shall not be less than \$10,000 per annum nor more than \$15,000 per annum, and shall be subject to the approval of the Civil Service Commission.

SEC. 2. Positions created pursuant to this Act shall be included in the classified civil service of the United States, but appointments to such positions shall be made without competitive examination upon approval of the proposed appointee's qualifications by the Civil Service Commission or such officers or agents as it may designate for this purpose.

\* \* \* \* \*

October 15, 1949, 63 Stat. 886 (Public Law 366—81st Congress, 1st session)  
Authorization for the Boulder Laboratories.

[CHAPTER 703]

AN ACT

To authorize the construction and equipment of a radio laboratory building for the National Bureau of Standards, Department of Commerce.

*Be it enacted by the Senate and House of Representatives of the United States of America in Congress assembled,* That there is hereby authorized to be constructed and equipped for the National Bureau of Standards a suitable radio laboratory building, together with necessary utilities and appurtenances thereto, under a limit of cost of \$4,475,000: *Provided,* That such limit of cost may be exceeded or shall be reduced by an amount equal to the percentage increase or decrease, if any, in construction costs generally dating from March 1, 1948, as determined by the Federal works Administrator.

SEC. 2. The Secretary of Commerce is authorized to acquire, by purchase, condemnation, or otherwise (including transfer with or without compensation from Federal agencies), such lands, estates in lands, and appurtenances thereto as may in his opinion be necessary or desirable for the construction of buildings to house activities of the National Bureau of Standards: *Provided,* That the site therefor shall be selected after consultation with the Director of the National Bureau of Standards.

SEC. 3. There are hereby authorized to be appropriated to the Secretary of Commerce, out of any moneys in the Treasury not otherwise appropriated, such sums as may be necessary to carry out the provisions of this Act: *Provided,* That such sums so appropriated, except such part thereof as may be necessary for the incidental expenses of the Department of Commerce, shall be transferred to the Public Buildings Administration in the Federal works Agency.

Approved October 25, 1949.

\* \* \* \* \*

October 25, 1949, 63 Stat. 905 (Public Law 386—81st Congress, 1st session)

Authorization for a guided-missile research laboratory ultimately located on the site of a former United States Naval Hospital at Corona, California.

[CHAPTER 728]

AN ACT

To authorize the construction and equipment of a guided-missile research laboratory building for the National Bureau of Standards, Department of Commerce.

*Be it enacted by the Senate and House of Representatives of the United States of America in Congress assembled,* That there is hereby authorized to be constructed and equipped for the National Bureau of Standards a research laboratory building, suitable for use as a guided-missile laboratory, together with necessary utilities and appurtenances thereto, under a limit of cost of \$1,900,000: *Provided,* That such limit of cost may be exceeded or shall be reduced by an amount equal to the percentage increase or decrease, if any, in construction cost generally dating from June 1, 1948, as determined by the Federal Works Administrator: *Provided further,* That such limit of cost shall not be exceeded by more than 10 per centum.

SEC. 2. The Secretary of Commerce is authorized to acquire, by purchase, condemnation, or otherwise (including transfer with or without compensation from Federal agencies), such lands, estates in lands, and appurtenances thereto as may in his opinion be necessary or desirable for the construction of a building to house activities of such laboratory for the National Bureau of Standards: *Provided,* That the site therefor shall be selected after consultation with the Director of the National Bureau of Standards.

SEC. 3. There are hereby authorized to be appropriated to the Secretary of Commerce, out of any moneys in the Treasury not otherwise appropriated, such sums as may be necessary to carry out the provisions of this Act: *Provided,* That such sums so appropriated, except such part thereof as may be necessary for the incidental expenses of the Department of Commerce, shall be transferred to the Public Buildings Administration in the Federal Works Agency.

Approved October 25, 1949.

\* \* \* \* \*

October 28, 1949, 63 Stat. 954 (Public Law 429—81st Congress, 1st session) *Classification Act of 1949*. The number of positions for the whole Civil Service in grades GS-16, GS-17, and GS-18 were specified. Periodic revisions in number and salary were made. In 1965, the National Bureau of Standards had 39 appointees in GS-16 and 29 in GS-17.

[CHAPTER 782]

#### AN ACT

To establish a standard schedule of rates of basic compensation for certain employees of the Federal Government; to provide an equitable system for fixing and adjusting the rates of basic compensation of individual employees; to repeal the Classification Act of 1923, as amended; and for other purposes.

*Be it enacted by the Senate and House of Representatives of the United States of America in Congress assembled*, That this Act may be cited as the "Classification Act of 1949".

#### TITLE I—DECLARATION OF POLICY

SEC. 101. It is the purpose of this Act to provide a plan for classification of positions and for rates of basic compensation whereby—

- (1) in determining the rate of basic compensation which an officer or employee shall receive, (A) the principle of equal pay for substantially equal work shall be followed, and (B) variations in rates of basic compensation paid to different officers and employees shall be in proportion to substantial differences in the difficulty, responsibility, and qualification requirements of the work performed and to the contributions of officers and employees to efficiency and economy in the service; and
- (2) individual positions shall, in accordance with their duties, responsibilities, and qualification requirements, be so grouped and identified by classes and grades, as defined in section 301, and the various classes shall be so described in published standards, as provided for in title IV, that the resulting position-classification system can be used in all phases of personnel administration.

\* \* \* \* \*

January 23, 1950, 3 C.F.R. 76 (1950).

#### EXECUTIVE ORDER 10096

PROVIDING FOR A UNIFORM PATENT POLICY FOR THE GOVERNMENT WITH RESPECT TO INVENTIONS MADE BY GOVERNMENT EMPLOYEES AND FOR THE ADMINISTRATION OF SUCH POLICY.

WHEREAS inventive advances in scientific and technological fields frequently result from governmental activities carried on by Government employees; and

WHEREAS the Government of the United States is expending large sums of money annually for the conduct of these activities; and

WHEREAS these advances constitute a vast national resource; and

WHEREAS it is fitting and proper that the inventive product of functions of the Government, carried out by Government employees, should be available to the Government in appropriate instances; and

WHEREAS the rights of Government employees in their inventions should be recognized in appropriate instances; and

WHEREAS the carrying out of the policy of this order requires appropriate administrative arrangements:

NOW, THEREFORE, by virtue of the authority vested in me by the Constitution and statutes, and as President of the United States and Commander in Chief of the Armed Forces of the United States, in the interest of the establishment and operation of a uniform patent policy for the Government with respect to inventions made by Government employees, it is hereby ordered as follows:

1. The following basic policy is established for all Government agencies with respect to inventions hereafter made by any Government employee:

- (a) The Government shall obtain the entire right, title and interest in and to all inventions made by any Government employee (1) during working hours, or (2) with a contribution by the Government of facilities, equipment, materials, funds, or information, or of time or services of other Government

employees on official duty, or (3) which bears a direct relation to or are made in consequence of the official duties of the inventor.

(b) In any case where the contribution of the Government, as measured by any one or more of the criteria set forth in paragraph (a) last above, to the invention is insufficient equitably to justify a requirement of assignment to the Government of the entire right, title and interest to such invention, or in any case where the Government has insufficient interest in an invention to obtain entire right, title and interest therein (although the Government could obtain same under paragraph (a) above), the Government agency concerned, subject to the approval of the Chairman of the Government Patents Board . . . shall leave title to such invention in the employee, subject, however, to the reservation to the Government of a non-exclusive, irrevocable, royalty-free license in the invention with power to grant licenses for all governmental purposes, such reservation, in the terms thereof, to appear, where practicable, in any patent, domestic or foreign, which may issue on such invention. . . .

\* \* \* \* \*

March 13, 1950, effective May 24, 1950, 64 Stat. 1263 (Reorganization Plan No. 5 of 1950)

The functions of all the officers of the National Bureau of Standards were transferred to the Secretary of Commerce, with power vested in him to authorize their performance or the performance of any of his functions by any of the officers or employees of the National Bureau of Standards.

#### REORGANIZATION PLAN NO. 5 OF 1950

Prepared by the President and transmitted to the Senate and the House of Representatives in Congress assembled, March 13, 1950, pursuant to the provisions of the Reorganization Act of 1949, approved June 20, 1949.

#### DEPARTMENT OF COMMERCE

SECTION 1. *Transfer of functions to the Secretary.*—(a) Except as otherwise provided in subsection (b) of this section, there are hereby transferred to the Secretary of Commerce all functions of all other officers of the Department of Commerce and all functions of all agencies and employees of such Department. . . .

SEC. 2. *Performance of functions of Secretary.*—The Secretary of Commerce may from time to time make such provisions as he shall deem appropriate authorizing the performance by any other officer, or by any agency or employee, of the Department of Commerce of any function of the Secretary, including any function transferred to the Secretary, including any function transferred to the Secretary by the provisions of this reorganization plan. . . .

SEC. 4. *Incidental transfers.*—The Secretary of Commerce may from time to time effect such transfers with the Department of Commerce of any of the records, property, personnel, and unexpended balances (available or to be made available) of appropriations, allocations, and other funds of such Department as he may deem necessary in order to carry out the provisions of this reorganization plan.

\* \* \* \* \*

June 29, 1950, 64 Stat. 275 (Public Law 583, 81st Congress, 2d session) *Deficiency Appropriation Act, 1950.*  
Beginning of the Working Capital Fund for the National Bureau of Standards.

[CHAPTER 405]

#### AN ACT

Making appropriations to supply deficiencies in certain appropriations for the fiscal year ending June 30, 1950, and for other purposes.

#### NATIONAL BUREAU OF STANDARDS WORKING CAPITAL FUND

For the establishment of a working capital fund, to be available without fiscal year limitation, for expenses necessary for the maintenance and operation of the National Bureau of Standards, including the furnishing of facilities and services to other Government agencies, not to exceed \$3,000,000. Said fund shall be established as a special deposit account and shall be reimbursed from applicable appropriations of said Bureau for

the work of said Bureau, and from funds of other Government agencies for facilities and services furnished to such agencies pursuant to law. Reimbursements so made shall include handling and related charges; reserves for depreciation of equipment and accrued leave; and building construction and alterations directly related to the work for which reimbursement is made. (64 Stat. 279)

\* \* \* \* \*

July 21, 1950, 64 Stat. 369 (Public Law 617, 81st Congress, 2d session)

The basic definitions of the act of 1894 were kept but eliminated the alternative definitions specifying devices which were not correct, gave clear legal effect in the United States to a world-wide agreement on electrical units and standards which had been obtained by the National Bureau of Standards, and established in scientific terms definitions of the units of light which had never been specifically established by Federal statutes.

[CHAPTER 484]

#### AN ACT

To redefine the units and establish the standards of electrical and photometric measurements.

*Be it enacted by the Senate and House of Representatives of the United States of America in Congress assembled,* That from and after the date this Act is approved, the legal units of electrical and photometric measurement in the United States of America shall be those defined and established as provided in the following sections.

SEC. 2. The unit of electrical resistance shall be the ohm, which is equal to one thousand million units of resistance of the centimeter-gram-second system of electromagnetic units.

SEC. 3. The unit of electric current shall be the ampere, which is one-tenth of the unit of current of the centimeter-gram-second system of electromagnetic units.

SEC. 4. The unit of electromotive force and of electric potential shall be the volt, which is the electromotive force that, steadily applied to a conductor whose resistance is one ohm, will produce a current of one ampere.

SEC. 5. The unit of electric quantity shall be the coulomb, which is the quantity of electricity transferred by a current of one ampere in one second.

SEC. 6. The unit of electrical capacitance shall be the farad, which is the capacitance of a capacitor that is charged to a potential of one volt by one coulomb of electricity.

SEC. 7. The unit of electrical inductance shall be the henry, which is the inductance in a circuit such that an electromotive force of one volt is induced in the circuit by variation of an inducing current at the rate of one ampere per second.

SEC. 8. The unit of power shall be the watt, which is equal to ten million units of power in the centimeter-gram-second system, and which is the power required to cause an unvarying current of one ampere to flow between points differing in potential by one volt.

SEC. 9. The units of energy shall be (a) the joule, which is equivalent to the energy supplied by a power of one watt operating for one second, and (b) the kilowatt-hour, which is equivalent to the energy supplied by a power of one thousand watts operating for one hour.

SEC. 10. The unit of intensity of light shall be the candle, which is one-sixtieth of the intensity of one square centimeter of a perfect radiator, known as a "black body", when operated at the temperature of freezing platinum.

SEC. 11. The unit of flux of light shall be the lumen, which is the flux in a unit of solid angle from a source of which the intensity is one candle.

SEC. 12. It shall be the duty of the Secretary of Commerce to establish the values of the primary electric and photometric units in absolute measure, and the legal values for these units shall be those represented by, or derived from, national reference standards maintained by the Department of Commerce.

SEC. 13. The Act of July 12, 1894 (Public Law Numbered 105, Fifty-third Congress), entitled "An Act to define and establish the units of electrical measure", is hereby repealed.

Approved July 21, 1950.

\* \* \* \* \*

July 22, 1950, 64 Stat. 371 (Public Law 619, 81 Congress, 2d session)

First major restatement of Bureau functions since 1901. The Act rewrote section 2 in its entirety and expanded its provisions to cover the standards and measurements functions and activities of the Department of Commerce.

[CHAPTER 486]

#### AN ACT

To amend section 2 of the Act of March 3, 1901 (31 Stat. 1449), to provide basic authority for the performance of certain functions and activities of the Department of Commerce, and for other purposes.

*Be it enacted by the Senate and House of Representatives of the United States of America in Congress assembled,* That section 2 of the Act of March 3, 1901 (31 Stat. 1449), as amended, be, and the same hereby is, further amended so as to read in full as follows:

"SEC. 2. The Secretary of Commerce (hereinafter referred to as the 'Secretary') is authorized to undertake the following functions:

"(a) The custody, maintenance, and development of the national standards of measurement, and the provision of means and methods for making measurements consistent with those standards, including the comparison of standards used in scientific investigations, engineering, manufacturing, commerce, and educational institutions with the standards adopted or recognized by the Government.

"(b) The determination of physical constants and properties of materials when such data are of great importance to scientific or manufacturing interests and are not to be obtained of sufficient accuracy elsewhere.

"(c) The development of methods for testing materials, mechanisms, and structures, and the testing of materials, supplies, and equipment, including items purchased for use of Government departments and independent establishments.

"(d) Cooperation with other governmental agencies on scientific and technical problems.

"(e) Advisory service to Government agencies on scientific and technical problems.

"(f) Invention and development of devices to serve special needs of the Government.

"In carrying out the functions enumerated in the section, the Secretary is authorized to undertake the following activities and similar ones for which need may arise in the operations of Government agencies, scientific institutions, and industrial enterprises:

"(1) the construction of physical standards;

"(2) the testing, calibration, and certification of standards and standard measuring apparatus;

"(3) the study and improvement of instruments and methods of measurements;

"(4) the investigation and testing of railroad track scales, elevator scales, and other scales used in weighing commodities for interstate shipment;

"(5) cooperation with the States in securing uniformity in weights and measures laws and methods of inspection;

"(6) the preparation and distribution of standard samples such as those used in checking chemical analyses, temperature, color, viscosity, heat of combustion, and other basic properties of materials; also the preparation and sale or other distribution of standard instruments, apparatus and materials for calibration of measuring equipment;

"(7) the development of methods of chemical analysis and synthesis of materials, and the investigation of the properties of rare substances;

"(8) the study of methods of producing and of measuring high and low temperatures; and the behavior of materials at high and at low temperatures;

"(9) the investigation of radiation, radioactive substances, and X-rays, their uses, and means of protection of persons from their harmful effects;

"(10) the study of the atomic and molecular structure of the chemical elements, with particular reference to the characteristics of the spectra emitted, the use of spectral observations in determining chemical composition of materials, and the relation of molecular structure to the practical usefulness of materials;

"(11) the broadcasting of radio signals for standard frequency;

"(12) the investigation of the conditions which affect the transmission of radio waves from their source to a receiver;

“(13) the compilation and distribution of information on such transmission of radio waves as a basis for choice of frequencies to be used in radio operation;

“(14) the study of new technical processes and methods of fabrication of materials in which the Government has a special interest; also the study of methods of measurement and technical processes used in the manufacture of optical glass and pottery, brick, tile, terra cotta, and other clay products;

“(15) the determination of properties of building materials and structural element, and encouragement of their standardization and most effective use, including investigation of fire-resisting properties of building materials and conditions under which they may be most efficiently used, and the standardization of types of appliances for fire prevention;

“(16) metallurgical research, including study of alloy steels and light metal alloys; investigation of foundry practice, casting, rolling, and forging; prevention of corrosion of metals and alloys; behavior of bearing metals; and development of standards for metals and sands;

“(17) the operation of a laboratory of applied mathematics;

“(18) the prosecution of such research in engineering, mathematics, and the physical sciences as may be necessary to obtain basic data pertinent to the functions specified herein; and

“(19) the compilation and publication of general scientific and technical data resulting from the performance of the functions specified herein or from other sources when such data are of importance to scientific or manufacturing interests or to the general public, and are not available elsewhere, including demonstrations of the results of the Bureau’s work by exhibits or otherwise as may be deemed most effective.”

SEC. 2. The Act of March 3, 1901 (31 Stat. 1449), as amended, be, and the same hereby is, further amended by inserting at the end thereof the following sections:

“SEC. 11. For all services rendered for other Government agencies by the Secretary in the performance of functions specified herein, the Department of Commerce may be reimbursed in accordance with section 601 of the Economy Act of June 30, 1932.

“SEC. 12. In the absence of specific agreement to the contrary, equipment purchased by the Department of Commerce from transferred or advanced funds in order to carry out an investigation authorized herein for another Government agency shall become the property of the Department of Commerce for use in subsequent investigations.

“SEC. 13. (a) The Secretary of Commerce is authorized to accept and utilize gifts or bequests of real or personal property for the purpose of aiding and facilitating the work authorized herein.

“(b) For the purpose of Federal income, estate, and gift taxes, gifts and bequests accepted by the Secretary of Commerce under the authority of the Act shall be deemed to be gifts and bequests to or for the use of the United States.”

Approved July 22, 1950

\* \* \* \* \*

September 9, 1950, 64 Stat. 823 (Public Law 776—81st Congress, 2d session)

The Technical Documentation Center in the Department of Commerce was transferred to the National Bureau of Standards in 1964. Reorganized and renamed the Clearinghouse for Federal Scientific and Technical Information, it provided inexpensive unclassified information about government-sponsored research and development in national programs.

[CHAPTER 936]

#### AN ACT

To provide for the dissemination of technological, scientific, and engineering information to American business and industry, and for other purposes.

*Be it enacted by the Senate and House of Representatives of the United States of America in Congress assembled,* That the purpose of this Act is to make the results of technological research and development more readily available to industry and business, and to the general public, by clarifying and defining the functions and responsibilities of the Department of Commerce as a central clearinghouse for technical information which is useful to American industry and business.



CLEARINGHOUSE FOR TECHNICAL INFORMATION

SEC. 2. The Secretary of Commerce (hereinafter referred to as the "Secretary") is hereby directed to establish and maintain within the Department of Commerce a clearinghouse for the collection and dissemination of scientific, technical, and engineering information, and to this end to take such steps as he may deem necessary and desirable—

(a) To search for, collect, classify, coordinate, integrate, record, and catalog such information from whatever sources, foreign and domestic, that may be available;

(b) To make such information available to industry and business, to State and local governments, to other agencies of the Federal Government, and to the general public, through the preparation of abstracts, digests, translations, bibliographies, indexes, and microfilm and other reproductions, for distribution either directly or by utilization of business, trade, technical, and scientific publications and services;

(c) To effect, within the limits of his authority as now or hereafter defined by law, and with the consent of competent authority, the removal of restrictions on the dissemination of scientific and technical data in cases where consideration of national security permit the release of such data for the benefit of industry and business.

\* \* \* \* \*

June 30, 1953, 67 Stat. 111 (Public Law 88—83d Congress, 1st session) *Flammable Fabrics Act*.

Mandatory flammability standards were set for wearing apparel and fabrics in interstate commerce. The standards relied on the voluntary commercial standards adopted by industry working with the National Bureau of Standards over several years to produce these standards for the industry.

Public Law 88

CHAPTER 164

AN ACT

To prohibit the introduction or movement in interstate commerce of articles of wearing apparel and fabrics which are so highly flammable as to be dangerous when worn by individuals, and for other purposes.

STANDARD OF FLAMMABILITY

SEC. 4. (a) Any fabric or article of wearing apparel shall be deemed so highly flammable within the meaning of section 3 of this Act as to be dangerous when worn by individuals if such fabric or any uncovered or exposed part of such article of wearing apparel exhibits rapid and intense burning when tested under the conditions and in the manner prescribed in the Commercial Standard promulgated by the Secretary of Commerce effective January 30, 1953, and identified as "Flammability of Clothing Textiles, Commercial Standard 191-53", or exhibits a rate of burning in excess of that specified in paragraph 3.11 of the Commercial Standard promulgated by the Secretary of Commerce effective May 22, 1953, and identified as "General Purpose Vinyl Plastic Film, Commercial Standard 192-53". For the purposes of this Act, such Commercial Standard 191-53 shall apply with respect to the hats, gloves, and footwear.

(b) If at any time the Secretary of Commerce finds that the Commercial Standards referred to in subsection (a) of this section are inadequate for the protection of the public interest, he shall submit to the Congress a report setting forth his findings together with such proposals for legislation as he deems appropriate. (67 Stat. 112)

\* \* \* \* \*

June 20, 1956, 70 Stat. 314 (Public Law 604—84th Congress, 2d session)

Formal approval for the construction of new Bureau laboratories at Gaithersburg.

Public Law 604

CHAPTER 415

AN ACT

Making appropriations for the Department of Commerce and related agencies for the fiscal year ending June 30, 1957, and for other purposes.

NATIONAL BUREAU OF STANDARDS

Construction of facilities: For acquisition of necessary land and to initiate the design of the facilities to be constructed thereon for the National Bureau of Standards outside of the District of Columbia to remain available until expended, \$930,000, to be transferred to the General Services Administration. (70 Stat. 321)

\* \* \* \* \*

August 2, 1956, 70 Stat. 953 (Public Law 930—84th Congress, 2d session)

The Secretary of Commerce was directed to prescribe commercial standards for a safety device which would enable the refrigerator door to be opened from the inside. The National Bureau of Standards, with the cooperation of the refrigerator manufacturing industry, engaged in experiments to determine the basic criteria of reasonable safety which manufacturers could incorporate in the design of their refrigerators for preventing the suffocation of children entrapped in refrigerators.

Public Law 930

CHAPTER 890

AN ACT

To require certain safety devices on household refrigerators shipped in interstate commerce.

SEC. 3. The Secretary of Commerce shall prescribe and publish in the Federal Register commercial standards for devices which, when used in or on household refrigerators, will enable the doors thereof to be opened easily from the inside; and the standards first established under this section shall be so prescribed and published not later than one year after the date of the enactment of this Act.

\* \* \* \* \*

August 3, 1956, 70 Stat. 959 (Public Law 940, 84th Congress, 2d session)

The Organic Act of the National Bureau of Standards was amended by Section 7 of this law which authorized the Bureau to retain fees received from the public for services performed, and allowed the Bureau to charge fixed prices for services performed for other agencies. Section 12 (a) incorporated authority for use of the Working Capital Fund in the Organic Act, and permitted changes in the accounting treatment under the fund.

Public Law 940

AN ACT

To amend the Act of March 3, 1901 (31 Stat. 1449) as amended, to incorporate in the Organic Act of the National Bureau of Standards the authority to use the Working Capital Fund, and to permit certain improvements in fiscal practices.

"SEC. 7. The Secretary shall charge for services performed under the authority of section 3 of this Act, except in cases where he determines that the interest of the Government would be best served by waiving the charge. Such charges may be based upon fixed prices or cost. The appropriation or fund bearing the cost of the services may be reimbursed, or the Secretary may require advance payment subject to such adjustment on completion of the work as may be agreed upon.

"Sec. 12. (a) The National Bureau of Standards is authorized to utilize in the performance of its functions the Working Capital Fund established by the Act of June 29, 1950 (64 Stat. 275), and additional amounts as from time to time may be required for the purposes of said fund are hereby authorized to be appropriated.

\* \* \* \* \*

November 4, 1963, 77 Stat. 299 (Public Law 88-165, 88th Congress, 1st session)

Public Law 88-165

AN ACT

To amend the Act redefining the units and establishing the standards of electrical and photometric measurements to provide that the candela shall be the unit of luminous intensity.

*Be it enacted by the Senate and House of Representatives of the United States of America in Congress assembled,* That the Act entitled "An Act to redefine the units and establish the standards of electrical and photometric measurement" (Act of July 21, 1950; (64 Stat. 370) is amended by deleting the word "candle" wherever it appears and inserting in lieu thereof the word "candela".

Approved November 4, 1963.

\* \* \* \* \*

October 30, 1965, 79 Stat. 1127 (Public Law 89-306—89th Congress, 1st session) "Brooks Act"

As the technical representative of the Department of Commerce, the National Bureau of Standards established the Center for Computer Sciences and Technology to improve the effectiveness and efficiency of the government's use of computers.

Public Law 89-306

AN ACT

To provide for the economic and efficient purchase, lease, maintenance, operation, and utilization of automatic data processing equipment by Federal departments and agencies.

"AUTOMATIC DATA PROCESSING EQUIPMENT

"(f) The Secretary of Commerce is authorized (1) to provide agencies, and the Administrator of General Services in the exercise of the authority delegated in this section, with scientific and technological advisory services relating to automatic data processing and related systems, and (2) to make appropriate recommendations to the President relating to the establishment of uniform Federal automatic data processing standards. The Secretary of Commerce is authorized to undertake the necessary research in the sciences and technologies of automatic data processing computer and related systems, as may be required under provisions of this subsection. (70 Stat. 1128)

\* \* \* \* \*

September 9, 1966, 80 Stat. 718 (Public Law 89-563—89th Congress, 2d session) *National Traffic and Motor Vehicle Safety Act of 1966.*

The Secretary of Commerce was to use the facilities of the National Bureau of Standards to initiate and conduct research, testing, development, and evaluation in cooperation with other Federal departments and agencies. The brake fluid and seat belt legislation passed in 1962 and 1963 was repealed by this broader law.

Public Law 89-563

AN ACT

To provide for a coordinated national safety program and establishment of safety standards for motor vehicles in interstate commerce to reduce accidents involving motor vehicles and to reduce the death and injuries occurring in such accidents.

SEC. 103. (f) In prescribing standards under this section, the Secretary shall—

(1) consider relevant available motor vehicle safety data, including the results of research, development, testing and evaluation activities conducted pursuant to the Act; . . . (80 Stat. 719)

\* \* \* \* \*

October 15, 1966, 80 Stat. 931 (Public Law 89-670—89th Congress, 2d session) *Department of Transportation Act*.

The functions, powers, and duties given to the Secretary of Commerce under the *National Traffic and Motor Vehicle Safety Act of 1966* were transferred to the Secretary of Transportation. The Office of Vehicle Systems Research was formed at the National Bureau of Standards in March 1967.

Public Law 89-670

AN ACT

To establish a Department of Transportation and for other purposes.

TRANSFERS TO DEPARTMENT

SEC. 6. (a) There are hereby transferred to and vested in the Secretary all functions, powers, and duties of the Secretary of Commerce and other offices and officers of the Department of Commerce under—

(6) the following laws relating generally to traffic and highway safety:

(A) The National Traffic and Motor Vehicle Safety Act of 1966 (80 Stat. 718).

(B) The Highway Safety Act of 1966 (80 Stat. 731).

\* \* \* \* \*

November 3, 1966, 80 Stat. 1296 (Public Law 89-755—89th Congress, 2d session) *Fair Packaging and Labeling Act*.

The National Bureau of Standards was given the responsibility to work with industry to reduce the number of package sizes, and to make labels more informative.

Public Law 89-755

AN ACT

To regulate interstate and foreign commerce by preventing the use of unfair or deceptive methods of packaging or labeling of certain consumer commodities distributed in such commerce, and for other purposes.

SEC. 5. (d) Whenever the Secretary of Commerce determines that there is undue proliferation of the weights, measures, or quantities in which any consumer commodity or reasonably comparable consumer commodities are being distributed in packages for sale at retail and such undue proliferation impairs the reasonable ability of consumers to make value comparisons with respect to such consumer commodity or commodities, he shall request manufacturers, packers, and distributors of the commodity or commodities to participate in the development of a voluntary product standard for such commodity or commodities under the procedures for the development of voluntary products standards established by the Secretary pursuant to section 2 of the Act of March 3, 1901 (31 Stat. 1449, as amended; 15 U.S.C. 272). Such procedures shall provide adequate manufacturer, packer, distributor, and consumer representation.

(e) If (1) after one year after the date on which the Secretary of Commerce first makes the request of manufacturers, packers, and distributors to participate in the development of a voluntary product standard as provided in subsection (d) of this section, he determines that such a standard will not be published pursuant to the provisions of such subsection (d), or (2) if such a standard is published and the Secretary of Commerce determines that it has not been observed, he shall promptly report such determination to the Congress with a statement of the efforts that have been made under the voluntary standards program and his recommendation as to whether Congress should enact legislation providing regulatory authority to deal with the situation in question. (80 Stat. 1299)

REPORTS TO THE CONGRESS

SEC. 8. Each officer or agency required or authorized by the Act to promulgate regulations for the packaging or labeling of any consumer commodity, or to participate in the development of voluntary product standards with respect to any consumer commodity under procedures referred to in section 5 (d) of this Act, shall transmit to the Congress in January of each year a report containing a full and complete description of the activities of that officer or agency for the administration and enforcement of this Act during the preceding fiscal year.

COOPERATION WITH STATE AUTHORITIES

SEC. 9. (a) A copy of each regulation promulgated under this Act shall be transmitted promptly to the Secretary of Commerce, who shall (1) transmit copies thereof to all appropriate State officers and agencies, and (2) furnish to such State officers and agencies information and assistance to promote to the greatest practicable extent uniformity in State and Federal regulation of the labeling of consumer commodities.

(b) Nothing contained in this section shall be construed to impair or otherwise interfere with any program carried into effect by the Secretary of Health, Education, and Welfare under other provisions of law in cooperation with State government or agencies, instrumentalities, or political subdivisions thereof. (80 Stat. 1300)

\* \* \* \* \*

December 14, 1967, 81 Stat. 568 (Public Law 90-189—90th Congress, 1st session)

*The Flammable Fabrics Act* amendments provided a mechanism for continued evaluation and revision to keep the requirements up-to-date and extended coverage to flammable interior furnishings. The Secretary of Commerce was given the responsibility of developing mandatory flammability standards when necessary. NBS had the responsibility of providing the necessary technical information.

Public Law 90-189

AN ACT

To amend the Flammable Fabrics Act to increase the protection afforded consumers against injurious flammable fabrics.

SEC. 3. Section 4 of the Flammable Fabrics Act is amended to read as follows:

"REGULATION OF FLAMMABLE FABRICS

"SEC. 4. (a) Whenever the Secretary of Commerce finds on the basis of the investigations or research conducted pursuant to section 14 of this Act that a new or amended flammability standard or other regulation, including labeling, for a fabric, related material, or product may be needed to protect the public against unreasonable risk of the occurrence of fire leading to death or personal injury, or significant property damage, he shall institute proceedings for the determination of an appropriate flammability standard (including conditions and manner of testing) or other regulation or amendment thereto for such fabric, related material, or product.

"(b) Each standard, regulation, or amendment thereto promulgated pursuant to this section shall be based on findings that such standard, regulation, or amendment thereto is needed to adequately protect the public against unreasonable risk of the occurrence of fire leading to death, injury, or significant property damage, is reasonable, technologically practicable, and appropriate, is limited to such fabrics, related materials, or products which have been determined to present such unreasonable risks, and shall be stated in objective terms. Each such standard, regulation, or amendment thereto, shall become effective twelve months from the date on which such standard, regulation, or amendment is promulgated, unless the Secretary of Commerce finds for good cause shown that an earlier or later effective date is in the public interest and publishes the reason for such finding. Each such standard or regulation or amendment thereto shall exempt fabrics, related materials, or products in inventory or with the trade as of the date on which the standard, regulation, or amendment thereto, becomes effective except that, if the Secretary finds that any such fabric, related material, or product is so highly flammable as to be dangerous when used by consumers for the purpose for which it is intended, he may under such conditions as the Secretary may prescribe, withdraw, or limit the exemption for such fabric, related material, or product. (81 Stat. 569)

\* \* \* \* \*

March 1, 1968, 82 Stat. 34 (Public Law 90-259—90th Congress, 2d session) *Fire Research and Safety Act of 1968*.

The Fire Research and Safety Office was created to carry out the activities of the program.

Public Law 90-259

#### AN ACT

To amend the Organic Act of the National Bureau of Standards to authorize a fire research and safety program, and for other purposes.

#### Title I—FIRE RESEARCH AND SAFETY PROGRAM

##### DECLARATION OF POLICY

SEC. 101. The Congress finds that a comprehensive fire research and safety program is needed in this country to provide more effective measures of protection against the hazards of death, injury, and damage to property. The Congress finds that it is desirable and necessary for the Federal Government, in carrying out the provisions of this title, to cooperate with and assist public and private agencies. The Congress declares that the purpose of this title is to amend the Act of March 3, 1901, as amended, to provide a national fire research and safety program including the gathering of comprehensive fire data; a comprehensive fire research program; fire safety education and training programs; and demonstrations of new approaches and improvements in fire prevention and control, and reduction of death, personal injury, and property damage. Additionally, it is the sense of Congress that the Secretary should establish a fire research and safety center for administering this title and carrying out its purposes, including appropriate fire safety liaison and coordination.

##### AUTHORIZATION OF PROGRAM

SEC. 102. The Act entitled "An Act to establish the National Bureau of Standards", approved March 3, 1901, as amended (15 U.S.C. 271-278e, is further amended by adding the following sections:

"SEC. 16. The Secretary of Commerce (hereinafter referred to as the 'Secretary') is authorized to—

"(a) Conduct directly or through contracts or grants—

"(1) investigations of fires to determine their causes, frequency of occurrence, severity, and other pertinent factors;

"(2) research into the causes and nature of fires, and the development of improved methods and techniques for fire prevention, fire control, and reduction of death, personal injury, and property damage;

"(3) educational programs to—

"(A) inform the public of fire hazards and fire safety techniques, and

"(B) encourage avoidance of such hazards and use of such techniques;

"(4) fire information reference services, including the collection, analysis, and dissemination of data, research results, and other information, derived from this program or from other sources and related to fire protection, fire control, and reduction of death, personal injury, and property damage;

"(5) educational and training programs to improve, among other things—

"(A) the efficiency, operation, and organization of fire services, and

"(B) the capability of controlling unusual fire-related hazards and fire disasters; and

"(6) projects demonstrating—

"(A) improved or experimental programs of fire prevention, fire control, and reduction of death, personal injury, and property damage,

"(B) application of fire safety principles in construction, or

"(C) improvement of the efficiency, operation, or organization of the fire services.

"(b) Support by contracts or grants the development, for use by educational and other nonprofit institutions, of—

"(1) fire safety and fire protection engineering or science curriculums; and

"(2) fire safety courses, seminars, or other instructional materials and aids for the above curriculums or other appropriate curriculums or courses of instruction.

"SEC. 17. With respect to the functions authorized by section 16 of this Act—

"(a) Grants may be made only to States and local governments, other non-Federal public agencies, and nonprofit institutions. Such a grant may be up to 100 per centum of the total cost of the project for which such grant is made. The Secretary shall require, whenever feasible, as a condition of approval of a grant, that the recipient contribute money, facilities, or services to carry out the purpose for which the grant is sought. For the purposes of this section, 'State' means any State of the United States, the District of Columbia, the Commonwealth of Puerto Rico, the Virgin Islands, Guam, the Canal Zone, American Samoa, and the Trust Territory of the Pacific Islands; and 'public agencies' includes combinations or groups of States or local governments.

"(b) The Secretary may arrange with and reimburse the heads of other Federal departments and agencies for the performance of any such functions, and, as necessary or appropriate, delegate any of his powers under this section or section 16 of this Act with respect to any part thereof, and authorize the redelegation of such powers.

"(c) The Secretary may perform such functions without regard to section 3648 of the Revised Statutes (31 U.S.C. 529).

"(d) The Secretary is authorized to request any Federal department or agency to supply such statistics, data, program reports, and other materials as he deems necessary to carry out such functions. Each such department or agency is authorized to cooperate with the Secretary and, to the extent permitted by law, to furnish such materials to the Secretary. The Secretary and the heads of other departments and agencies engaged in administering programs related to fire safety shall, to the maximum extent practicable, cooperate and consult in order to insure fully coordinated efforts.

"(e) The Secretary is authorized to establish such policies, standards, criteria, and procedures and to prescribe such rules and regulations as he may deem necessary or appropriate to the administration of such functions or this section, including rules and regulations which—

"(1) provide that a grantee will from time to time, but not less often than annually, submit a report evaluating accomplishments of activities funded under section 16, and

"(2) provide for fiscal control, sound accounting procedures, and periodic reports to the Secretary regarding the application of funds paid under section 16."

\* \* \* \* \*

July 11, 1968, 82 Stat. 339 (Public Law 90-396—90th Congress, 2d session) *Standard Reference Data Act*.

This Act authorized the National Bureau of Standards to coordinate a National system for providing scientific data to science and industry, thereby strengthening and increasing the effectiveness of the Bureau's standard reference data operation.

Public Law 90-396

#### AN ACT

To provide for the collection, compilation, critical evaluation, publication, and sale of standard reference data.

#### DECLARATION OF POLICY

SECTION 1. The Congress hereby finds and declares that reliable standardized scientific and technical reference data are of vital importance to the progress of the Nation's science and technology. It is therefore the policy of the congress to make critically evaluated reference data readily available to scientists, engineers, and the general public. It is the purpose of this Act to strengthen and enhance this policy.

SEC. 2. For the purposes of this Act—

(a) The term "standard reference data" means quantitative information, related to a measurable physical or chemical property of a substance or system of substances of known composition and structure, which is critically evaluated as to its reliability under section 3 of this Act.

(b) The term "Secretary" means the Secretary of Commerce.

SEC. 3. The Secretary is authorized and directed to provide or arrange for the collection, compilation, critical evaluation, publication, and dissemination of standard reference data. In carrying out this program, the Secretary shall, to the maximum extent practicable, utilize the reference data services and facilities of other agencies and instrumentalities of the Federal Government and of State and local governments, persons, firms, institutions, and associations, with their consent and in such a manner as to avoid duplication of those services and facilities. All agencies and instrumentalities of the Federal Government are encouraged to exercise their duties and functions in such manner as will assist in carrying out the purpose of this Act. This section shall be deemed complementary to existing authority, and nothing herein is intended to repeal, supersede, or diminish existing authority or responsibility of any agency or instrumentality of the Federal Government.

SEC. 4. To provide for more effective integration and coordination of standard reference data activities, the Secretary, in consultation with other interested Federal agencies, shall prescribe and publish in the Federal Register such standards, criteria, and procedures for the preparation and publication of standard reference data as may be necessary to carry out the provisions of this Act.

SEC. 5. Standard reference data conforming to standards established by the Secretary may be made available and sold by the Secretary or by a person or agency designated by him. To the extent practicable and appropriate, the prices established for such data may reflect the cost of collection, compilation, evaluation, publication, and dissemination of the data, including administrative expenses; and the amounts received shall be subject to the Act of March 3, 1901, as amended (15 U.S.C. 271-278e).

SEC. 6. (a) Notwithstanding the limitations contained in section 9 of title 17 of the United States Code, the Secretary may secure copyright and renewal thereof on behalf of the United States as author or proprietor in all or any part of any standard reference data which he prepares or makes available under this Act, and may authorize the reproduction and publication thereof by others.

(b) The publication or republication by the Government under this Act, either separately or in a public document, of any material in which copyright is subsisting shall not be taken to cause any abridgment or annulment of the copyright or to authorize any use or appropriation of such material without the consent of the copyright proprietor.

SEC. 7. There are authorized to be appropriated to carry out this Act, \$1.86 million for the fiscal year ending June 30, 1969. Notwithstanding the provisions of any other law, no appropriations for any fiscal year may be made for the purpose of this Act after fiscal year 1969 unless previously authorized by the Congress.

SEC. 8. This Act may be cited as the "Standard Reference Data Act."

Approved July 11, 1968.

\* \* \* \* \*

August 9, 1968, 82 Stat. 693 (Public Law 90-472—90th Congress, 2d session) "Metric System Study".

The Act authorized a study of the effect upon the United States of increased use of the Metric System throughout the world and development of recommendations for an action program to deal with the problem.

Public Law 90-472

#### AN ACT

To authorize the Secretary of Commerce to make a study to determine the advantages and disadvantages of increased use of the metric system in the United States.

*Be it enacted by the Senate and House of Representatives of the United States of America in Congress assembled,* That the Secretary of Commerce is hereby authorized to conduct a program of investigation, research, and survey to determine the impact of increasing worldwide use of the metric system on the United States; to appraise the desirability and practicability of increasing the use of metric weights and measures in the United States; to study the feasibility of retaining and promoting by international use of dimensional and other engineering standards based on the customary measurement units of the United States; and to evaluate the costs and benefits of alternative courses of action which may be feasible for the United States.



SEC. 2. In carrying out the program described in the first section of this Act, the Secretary, among other things, shall—

(1) investigate and appraise the advantages and disadvantages to the United States in international trade and commerce, and in military and other areas of international relations, of the increased use of an international standardized system of weights and measures;

(2) appraise economic and military advantages and disadvantages of the increased use of the metric system in the United States or of the increased use of such system in specific fields and the impact of such increased use upon those affected;

(3) conduct extensive comparative studies of the systems of weights and measures used in educational, engineering, manufacturing, commercial, public, and scientific areas, and the relative advantages and disadvantages, and degree of standardization of each in its respective field;

(4) investigate and appraise the possible practical difficulties which might be encountered in accomplishing the increased use of the metric system of weights and measures generally or in specific fields or areas in the United States;

(5) permit appropriate participation by representatives of United States industry, science, engineering, and labor, and their associations, in the planning and conduct of the program authorized by the first section of this Act, and in the evaluation of the information secured under such program; and

(6) consult and cooperate with other government agencies, Federal, State, and local, and, to the extent practicable, with foreign governments and international organizations.

SEC. 3. In conducting the studies and developing the recommendations required in this Act, the Secretary shall give full consideration to the advantages, disadvantages, and problems associated with possible changes in either the system of measurement units or the related dimensional and engineering standards currently used in the United States, and specifically shall—

(1) investigate the extent to which substantial changes in the size, shape, and design of important industrial products would be necessary to realize the benefits which might result from general use of metric units of measurement in the United States;

(2) investigate the extent to which uniform and accepted engineering standards based on the metric system of measurement units are in use in each of the fields under study and compare the extent to such use and the utility and degree of sophistication of such metric standards with those in use in the United States; and

(3) recommend specific means of meeting the practical difficulties and costs in those areas of the economy where any recommended change in the system of measurement units and related dimensional and engineering standards would raise significant practical difficulties or entail significant costs of conversion.

SEC. 4. The Secretary shall submit to the Congress such interim reports as he deems desirable, and within three years after the date of the enactment of this Act, a full and complete report of the findings made under the program authorized by this Act, together with such recommendations as he considers to be appropriate and in the best interests of the United States.

SEC. 5. From funds previously appropriated to the Department of Commerce, the Secretary is authorized to utilize such appropriated sums as are necessary, but not to exceed \$500,000, to carry out the purposes of this Act for the first year of the program.

SEC. 6. This Act shall expire thirty days after the submission of the final report pursuant to section 3.

Approved August 9, 1968.

\* \* \* \* \*

October 27, 1972, 86 Stat. 1207 (Public Law 92-573—92d Congress, 2d session) *Consumer Product Safety Act*.

This Act established the Consumer Product Safety Commission and transferred the regulatory functions of the Secretary of Commerce under the Flammable Fabrics Act and the "Refrigerator Safety Devices Act" to the Commission. The National Bureau of Standards provided technical support to the CPSC.

AN ACT

To protect consumers against unreasonable risk of injury from hazardous products, and for other purposes.

COOPERATION WITH STATES AND WITH OTHER FEDERAL AGENCIES

SEC. 29. (d) The Commission shall, to the maximum extent practicable, utilize the resources and facilities of the National Bureau of Standards, on a reimbursable basis, to perform research and analyses related to risks of injury associated with consumer products (including fire and flammability risks), to develop test methods, to conduct studies and investigations, and to provide technical advice and assistance in connection with the functions of the Commission.

TRANSFERS OF FUNCTIONS

SEC. 30. (a) The functions of the Secretary of Health, Education, and Welfare under the Federal Hazardous Substances Act (15 U.S.C. 1261 et seq.) and the Poison Prevention Packaging Act of 1970 are transferred to the Commission. The functions of the Administrator of the Environmental Protection Agency and of the Secretary of Health, Education, and Welfare under the Acts amended by subsections (b) through (f) of section 7 of the Poison Prevention Packaging Act of 1970, to the extent such functions relate to the administration and enforcement of the Poison Prevention Packaging Act of 1970, are transferred to the Commission.

(b) The functions of the Secretary of Health, Education, and Welfare, the Secretary of Commerce, and the Federal Trade Commission under the Flammable Fabrics Act (15 U.S.C. 1191 et seq.) are transferred to the Commission. The functions of the Federal Trade Commission under the Federal Trade Commission Act, to the extent such functions relate to the administration and enforcement of the Flammable Fabrics Act, are transferred to the Commission.

(c) The functions of the Secretary of Commerce and the Federal Trade Commission under the Act of August 2, 1956 (15 U.S.C. 1211) are transferred to the Commission.

(d) A risk of injury which is associated with consumer products and which could be eliminated or reduced to a sufficient extent by action taken under the Federal Hazardous Substances Act, the Poison Prevention Packaging Act of 1970, or the Flammable Fabrics Act may be regulated by the commission only in accordance with the provisions of those Acts.

(e) (1) (A) All personnel, property, records, obligations, and commitments, which are used primarily with respect to any function transferred under the provisions of subsections (a), (b) and (c) of this section shall be transferred to the Commission, except those associated with fire and flammability research in the National Bureau of Standards. The transfer of personnel pursuant to this paragraph shall be without reduction in classification or compensation for one year after such transfer, except that the Chairman of the Commission shall have full authority to assign personnel during such one-year period in order to efficiently carry out functions transferred to the Commission under this section. (86 Stat. 1231)

\*\*\*\*\*

October 27, 1972, 86 Stat. 1234 (Public Law 92-574—92d Congress, 2d session) *Noise Control Act of 1972*.

The Administrator of the Environmental Protection Agency was authorized to conduct research on the effects, measurement, and control of noise.

Public Law 92-574

AN ACT

To control the emission of noise detrimental to the human environment, and for other purposes.

SEC. 14 (1) (B) development of improved methods and standards for measurement and monitoring of noise, in cooperation with the National Bureau of Standards, Department of Commerce; (86 Stat. 1245)

\*\*\*\*\*

September 3, 1974, 88 Stat. 1069 (Public Law 93-409—93d Congress, 2d session) *Solar Heating and Cooling Demonstration Act of 1974*.

The National Bureau of Standards was directed to determine what constituted an effective solar heating and cooling system.

Public Law 93-409

#### AN ACT

To provide for the early development and commercial demonstration of the technology of solar heating and combined solar heating and cooling systems.

SEC. 2. (b) It is therefore declared to be the policy of the United States and the purpose of this Act to provide for the demonstration within a three-year period of the practical use of solar heating technology, and to provide for the development and demonstration within a five-year period of the practical use of combined heating and cooling technology. (88 stat. 1069)

#### DEFINITIONS

SEC. 3. For purposes of this Act—

(1) the term "solar heating", with respect to any building, means the use of solar energy to meet such portion of the total heating needs of such building (including hot water), or such portion of the needs of such building for hot water (where its remaining heating needs are met by other methods), as may be required under performance criteria prescribed by the Secretary of Housing and Urban Development utilizing the services of the Director of the National Bureau of Standards, and in consultation with the Director of the National Science Foundation, and the Administrator of the National Aeronautics and Space Administration;

(2) the terms "solar heating and cooling" and "combined solar heating and cooling", with respect to any building, mean the use of solar energy to provide both such portion of the total heating needs of such building (including hot water) and such portion of the total cooling needs of such building, or such portion of the needs of such building for hot water (where its remaining heating needs are met by other methods) and such portion of the total cooling needs of a building, as may be required under performance criteria prescribed by the Secretary of Housing and Urban Development utilizing the services of the Director of the National Bureau of Standards, and in consultation with the Director of the National Science Foundation, and the Administrator of the National Aeronautics and Space Administration, and such term includes cooling by means of nocturnal heat radiation, by evaporation, or by other methods of meeting peakload energy requirements at nonpeakload times; (88 Stat. 1070)

#### DEVELOPMENT AND DEMONSTRATION OF SOLAR HEATING SYSTEMS TO BE USED IN RESIDENTIAL DWELLINGS

SEC. 5. (a) The Administrator and the Secretary shall promptly initiate and carry out a program, as provided in this section, for the development and demonstration of solar heating systems (including collectors, controls, and thermal storage) for use in residential dwellings.

(b) (1) Within 120 days after the date of the enactment of this Act, the Secretary, utilizing the services of the Director of the National Bureau of Standards and in consultation with the Administrator and the Director, shall determine, prescribe, and publish—

(A) interim performance criteria for solar heating components and systems to be used in residential dwellings, and

(B) interim performance criteria (relating to suitability for solar heating) for such dwellings themselves, taking into account in each instance climatic variations existing between different geographic areas.

(2) As soon as possible after the publication of the performance criteria prescribed under paragraph (1), the Secretary, in consultation with the Director of the National Bureau of Standards and the Administrator, will select on the basis of open competition a number of designs for various types of residential dwellings suitable for and adapted to the installation of solar heating systems meeting the performance criteria prescribed under paragraph (1) (A). (88 Stat. 1070)

DEVELOPMENT AND DEMONSTRATION OF COMBINED SOLAR HEATING AND COOLING SYSTEMS  
TO BE USED IN RESIDENTIAL DWELLINGS

SEC. 6. (a) The Administrator and the Secretary shall promptly initiate and carry out a program, as provided in this section, for the development and demonstration of combined solar heating and cooling systems (including collectors, controls, and thermal storage) for use in residential dwellings.

(b) (1) As soon as possible after the date of the enactment of this Act, the Secretary, utilizing the services of the Director of the National Bureau of Standards and in consultation with the Administrator and the Director, shall determine, prescribe, and publish—

(A) interim performance criteria for combined solar heating and cooling components and systems to be used in residential dwellings, and

(B) interim performance criteria (relating to suitability for solar heating and cooling) for such dwellings themselves, taking into account in each instance climatic variations existing between different geographic areas.

(2) As soon as possible after the publication of the performance criteria prescribed under paragraph (1) (and if possible before the completion of the research and development provided for in subsection (c)), the Secretary, in consultation with the Director of the National Bureau of Standards and the Administrator, will select on the basis of open competition a number of designs for various types of residential dwellings suitable for and adapted to the installation of combined solar heating and cooling systems meeting the performance criteria prescribed under paragraph (1) (A). (88 Stat. 1072)

DEVELOPMENT AND DEMONSTRATION OF SOLAR HEATING AND COMBINED SOLAR HEATING  
AND COOLING SYSTEMS FOR COMMERCIAL BUILDINGS

SEC. 9. The Administrator, in consultation with the Secretary, the Director, the Administrator of General Services, and the Director of the National Bureau of Standards and concurrently with the conduct of the programs under sections 5 and 6, shall enter into arrangements with appropriate Federal agencies to carry out such projects and activities (including demonstration projects) with respect to apartment buildings, office buildings, factories, crop-drying facilities and other agricultural structures, public buildings (including schools and colleges), and other non-residential, commercial, or industrial buildings, taking into account the special needs of and individual differences in such buildings based upon size, function, and other relevant factors, as may be appropriate for the early development and demonstration of solar heating and combined solar heating and cooling systems suitable and effective for use in such buildings. (88 Stat. 1074)

COORDINATION, MONITORING, AND LIAISON

SEC. 11. (a) The Secretary, utilizing the services of the Director of the National Bureau of Standards and in coordination with such other Government agencies as may be appropriate, shall—

(1) monitor the performance and operation of solar heating and combined solar heating and cooling systems installed in residential dwellings under this Act;

(2) collect and evaluate data and information on the performance and operation of solar heating and combined solar heating and cooling systems installed in residential dwellings under this Act; and

(3) from time to time, carrying out such studies and investigations and take such other actions, including the submission of special reports to the Congress when appropriate, as may be necessary to assure that the programs for which the Secretary is responsible under this Act effectively carry out the policy of this Act. (88 Stat. 1074)

DISSEMINATION OF INFORMATION AND OTHER ACTIONS TO PROMOTE PRACTICAL USE OF  
SOLAR HEATING AND COOLING TECHNOLOGIES

SEC. 12. (a) The Secretary shall take all possible steps to assure that full and complete information with respect to the demonstrations and other activities conducted under this Act is made available to Federal, State, and local authorities, the building industry and related segments of the economy, the scientific and technical community, and the public at large, both during and after the close of the programs under this Act,

with the objective of promoting and facilitating to the maximum extent feasible the early and widespread practical use of solar energy for the heating and cooling of buildings throughout the United States. In accordance with regulations prescribed under section 16 such information shall be disseminated on a coordinated basis by the Secretary, the Administrator, the Director of the National Bureau of Standards, the Director, the Commissioner of the Patent Office, and other appropriate Federal offices and agencies. (88 Stat. 1075)

#### REGULATIONS

SEC. 16. The Administrator and the Secretary in consultation with the Director of the National Bureau of Standards, the Director, the Administrator of the General Services Administration, the Secretary of Defense, and other appropriate officers and agencies, shall prescribe such regulations as may be necessary or appropriate to carry out this Act promptly and efficiently. Each such officer or agency, in consultation with the Administrator and the Secretary, may prescribe such regulations as may be necessary or appropriate to carry out his or its particular functions under this Act promptly and efficiently. (88 Stat. 1078).

\* \* \* \* \*

October 29, 1974, 88 Stat. 1535 (Public Law 93-498—93d Congress, 2d session) *Federal Fire Prevention and Control Act of 1974*.

The establishment of the Center for Fire Research reorganized and strengthened the fire research programs at the National Bureau of Standards.

Public Law 93-498

#### AN ACT

To reduce losses of life and property, through better fire prevention and control, and for other purposes.

#### PURPOSES

SEC. 3. It is declared to be the purpose of Congress in this Act to—

- (1) reduce the Nation's losses caused by fire through better fire prevention and control;
- (2) supplement existing programs of research, training, and activities by State and local governments;
- (3) establish the National Fire Prevention and Control Administration and the Fire Research Center within the Department of Commerce; and
- (4) establish an intensified program of research into the treatment of burn and smoke injuries and the rehabilitation of victims of fires within the National Institutes of Health. (88 Stat. 1536)

#### FIRE RESEARCH CENTER

SEC. 18. The Act of March 3, 1901 (15 U.S.C. 278), is amended by striking out sections 16 and 17 (as added by title I of the Fire Prevention and Control Act of 1968) and by inserting in lieu thereof the following new section:

"SEC. 16. (a) There is hereby established within the Department of Commerce a Fire Research Center which shall have the mission of performing and supporting research on all aspects of fire with the aim of providing scientific and technical knowledge applicable to the prevention and control of fires. The content and priorities of the research program shall be determined in consultation with the Administrator of the National Fire Prevention and Control Administration. In implementing this section, the Secretary is authorized to conduct, directly or through contracts or grants, a fire research program, including—

"(1) basic and applied fire research for the purpose of arriving at an understanding of the fundamental processes underlying all aspects of fire. Such research shall include scientific investigations of—

"(A) the physics and chemistry of combustion processes;

"(B) the dynamics of flame ignition, flame spread, and flame extinguishment;

"(C) the composition of combustion products developed by various sources and under various environmental conditions;

“(D) the early stages of fires in buildings and other structures, structural subsystems and structural components in all other types of fires, including, but not limited to, forest fires, brush fires, fires underground, oil blowout fires, and water-borne fires, with the aim of improving early detection capability;

“(E) the behavior of fires involving all types of buildings and other structures and their contents (including mobile homes and highrise buildings, construction materials, floor and wall coverings, coatings, furnishings, and other combustible materials), and all other types of fires, including forest fires, brush fires, fires underground, oil blowout fires, and waterborne fires;

“(F) the unique fire hazards arising from the transportation and use, in industrial and professional practices, of combustible gases, fluids, and materials;

“(G) design concepts for providing increased fire safety consistent with habitability, comfort, and human impact in buildings and other structures; and

“(H) such other aspects of the fire process as may be deemed useful in pursuing the objectives of the fire research program;

“(2) research into the biological, physiological, and psychological factors affecting human victims of fire, and the performance of individual members of fire services, including—

“(A) the biological and physiological effects of toxic substances encountered in fires;

“(B) the trauma, cardiac conditions, and other hazards resulting from exposure to fire;

“(C) the development of simple and reliable tests for determining the cause of death from fires;

“(D) improved methods of providing first aid to victims of fires;

“(E) psychological and motivational characteristics of persons who engage in arson, and the prediction and cure of such behavior;

“(F) the conditions of stress encountered by firefighters, the effects of such stress, and the alleviation and reduction of such conditions; and

“(G) such other biological, psychological, and physiological effects of fire as have significance for purposes of control or prevention of fires; and

“(3) operation tests, demonstration projects, and fire investigations in support of the activities set forth in this section.

“The Secretary shall insure that the results and advances arising from the work of the research program are disseminated broadly. He shall encourage the incorporation, to the extent applicable and practicable, of such results and advances in building codes, fire codes, and other relevant codes, test methods, fire service operations and training, and standards. The Secretary is authorized to encourage and assist in the development and adoption of uniform codes, test methods, and standards aimed at reducing fire losses and costs of fire protection.

“(b) For the purposes of this section there is authorized to be appropriated not to exceed \$3,500,000 for the fiscal year ending June 30, 1975 and not to exceed \$4,000,000 for the fiscal year ending June 30, 1976.” (88 Stat. 1545).

\* \* \* \* \*

December 31, 1974, 88 Stat. 1878 (Public Law 93-577—93d Congress, 2d session) *Federal Nonnuclear Energy Research and Development Act of 1974*.

The Office of Energy Related Inventions was established to help the Energy Research and Development Administration evaluate non-nuclear energy ideas.

Public Law 93-577

#### AN ACT

To establish a national program for research and development in nonnuclear energy sources.

#### ENERGY-RELATED INVENTIONS

SEC. 14. The National Bureau of Standards shall give particular attention to the evaluation of all promising energy-related inventions, particularly those submitted by individual inventors and small companies for the purpose of obtaining direct grants from the Administrator. The National Bureau of Standards is authorized to promulgate regulations in the furtherance of this section. (88 Stat. 1894)

\* \* \* \* \*

From the *United States Code, 1946 edition, Containing the General and Permanent Laws of the United States, in Force on January 2, 1947, pp. 1446-1447.*

Chapter 7.—THE BUREAU OF STANDARDS

Sec.

- 271. Bureau established.
- 272. Functions of Bureau.
- 273. Functions; for whom exercised.
- 274. Director; powers and duties; report.
- 275. Appointment of officers and employees.
- 276. Fees.
- 277. Regulations.
- 278. Visiting committee.
- 279. Absence of Director.
- 280. Apprentices; promotion.
- 281. Testing materials for District of Columbia.
- 282. National hydraulic laboratory; establishment; purpose; study of Federal and State projects.

§ 271. Bureau established.

The Office of Standard Weights and Measures shall be known as the National Bureau of Standards. (Mar. 3, 1901, ch. 872, § 1, 31 Stat. 1449.)

§ 272. Functions of Bureau.

The functions of the bureau shall consist in the custody of the standards; the comparison of the standards used in scientific investigations, engineering, manufacturing, commerce, and educational institutions with the standards adopted or recognized by the Government; the construction, when necessary, of standards, their multiples and subdivisions; the testing and calibration of standard measuring apparatus; the solution of problems which arise in connection with standards; the determination of physical constants and the properties of materials, when such data are of great importance to scientific or manufacturing interests and are not to be obtained of sufficient accuracy elsewhere. (Mar. 3, 1901, ch. 872, § 2, 31 Stat. 1449.)

§ 273. Functions; for whom exercised.

The bureau shall exercise its functions for the Government of the United States; for any State or municipal government within the United States; or for any scientific society, educational institution, firm, corporation, or individual within the United States engaged in manufacturing or other pursuits requiring the use of standards or standard measuring instruments. All requests for the services of the bureau shall be made in accordance with the rules and regulations herein established in sections 276 and 277 of this title. (Mar. 3, 1901, ch. 872, § 3, 31 Stat. 1449.)

§ 274. Director; powers and duties; report.

The director shall be appointed by the President, by and with the advice and consent of the Senate. He shall have the general supervision of the bureau, its equipment, and the exercise of its functions. He shall make an annual report to the Secretary of Commerce, including an abstract of the work done during the year and a financial statement. He may issue, when necessary, bulletins for public distribution, containing such information as may be of value to the public or facilitate the bureau in the exercise of its functions. (Mar. 3, 1901, ch. 872, § 5, 31 Stat. 1449; Feb. 14, 1903, ch. 552, § 10, 32 Stat. 829; Mar. 4, 1913, ch. 141, § 1, 37 Stat. 736.)

§ 275. Appointment of officers and employees.

The officers and employees of the bureau, except the director, shall be appointed by the Secretary of Commerce at such time as their respective services may become necessary. (Mar. 3, 1901, ch. 872, § 6, 31 Stat. 1450; Feb. 14, 1903, ch. 552, § 10, 32 Stat. 829; Mar. 4, 1913, ch. 141, § 1, 37 Stat. 736.)

§ 276. Fees.

For all comparisons, calibrations, tests, or investigations, performed by the National Bureau of Standards under sections 271—278 of this title, as amended and supplemented, except those performed for the Government of the United States or State governments within the United States, a fee sufficient in each case to compensate the National Bureau of Standards for the entire cost of the services rendered shall be charged, according to a schedule prepared by the Director of the National Bureau of Standards and approved by the Secretary of Commerce. All moneys received from such sources shall be paid into the Treasury to the credit of miscellaneous receipts. (Mar. 3, 1901, ch. 872, § 8, 31 Stat. 1450; Feb. 14, 1903, ch. 552, § 10, 32 Stat. 829; Mar. 4, 1913, ch. 141, § 1, 37 Stat. 736; June 30, 1932, ch. 314, § 312, 47 Stat. 410.)

§ 277. Regulations.

The Secretary of Commerce shall, from time to time, make regulations regarding the payment of fees, the limits of tolerance to be attained in standards submitted for verification, the sealing of standards, the disbursement and receipt of moneys, and such other matters as he may deem necessary for carrying this Act into effect sections 271—278 of this title. (Mar. 3, 1901, ch. 872, § 9, 31 Stat. 1450; Feb. 14, 1903, ch. 552, § 10, 32 Stat. 829; Mar. 4, 1913, ch. 141, § 1, 37 Stat. 736.)

§ 278. Visiting committee.

There shall be a visiting committee of five members, to be appointed by the Secretary of Commerce, to consist of men prominent in the various interests involved, and not in the employ of the Government. This committee shall visit the bureau at least once a year, and report to the Secretary of Commerce upon the efficiency of its scientific work and the condition of its equipment. The members of this committee shall serve without compensation, but shall be paid the actual expenses incurred in attending its meetings. The period of service of the members of the committee shall be so arranged that one member shall retire each year, and the appointments to be for a period of five years. Appointments made to fill vacancies occurring other than in the regular manner are to be made for the remainder of the period in which the vacancy exists. (Mar. 3, 1901, ch. 872, § 10, 31 Stat. 1450; Feb. 14, 1903, ch. 552, § 10, 32 Stat. 829; Mar. 4, 1913, ch. 141, § 1, 37 Stat. 736.)

§ 279. Absence of Director.

In the case of the absence of the Director of the Bureau of Standards the Secretary of Commerce may designate some officer of said bureau to perform the duties of the director during his absence. (Mar. 4, 1911, ch. 237, § 1, 36 Stat. 1231; Mar. 4, 1913, ch. 141, § 1, 37 Stat. 736.)

§ 280. Apprentices; promotion.

Apprentices in the Bureau of Standards may be promoted after satisfactory apprenticeship, with the approval of the Civil Service Commission, to positions corresponding to the journeyman grades for which their duties logically prepare them, without regard to apportionment: *Provided*, That they thus acquire no rights to transfer to other lines of work. (July 16, 1914, ch. 141, § 1, 38 Stat. 502.)

§ 281. Testing materials for District of Columbia.

Materials for fireproof buildings, other structural materials, and all materials, other than materials for paving and for fuel, purchased for and to be used by the government of the District of Columbia, when necessary in the judgment of the commissioners to be tested, shall be tested by the Bureau of Standards under the same conditions as similar testing is required to be done for the United States Government. (Mar. 4, 1913, ch. 150, 37 Stat. 945.)

§ 282. National hydraulic laboratory; establishment; purpose; study of Federal and State projects.

There is authorized to be established in the Bureau of Standards of the Department of Commerce a national hydraulic laboratory for the determination of fundamental data useful in hydraulic research and engineering, including laboratory research relating to the behavior and control of river and harbor waters, the study of hydraulic structures and water flow, and the development and testing of hydraulic instruments and



accessories; *Provided*, That no test, study, or other work on a problem or problems connected with a project the prosecution of which is under the jurisdiction of any department or independent agency of the Government shall be undertaken in the laboratory herein authorized until a written request to do such work is submitted to the Director of the Bureau of Standards by the head of the department or independent agency charged with the execution of such project: *And provided further*, That any State or political subdivision thereof may obtain a test, study, or other work on a problem connected with a project the prosecution of which is under the jurisdiction of such State or political subdivision thereof. (May 14, 1930, ch. 275, § 1, 46 Stat. 327.)

\* \* \* \* \*

From the *United States Code, 1952 edition, Containing the General and Permanent Laws of the United States, in Force on January 2, 1953*, pp. 1825-1830.

## Chapter 7.—THE BUREAU OF STANDARDS

Sec.

- 271. Bureau established.
- 272. Functions of Secretary.
- 273. Functions; for whom exercised.
- 274. Director; powers and duties; report.
- 275. Appointment of officers and employees.
- 276. Fees.
- 277. Regulations.
- 278. Visiting committee.
- 278a. Reimbursement from other Government agencies for services rendered.
- 278b. Ownership of equipment transferred to carry out investigations.
- 278c. Acceptance of gifts and bequests.
- 279. Absence of Director.
- 280. Apprentices; promotion.
- 281. Testing materials for District of Columbia.
- 282. National hydraulic laboratory; establishment; purpose; study of Federal and State projects.
- 283, 284. Omitted.
- 285. Availability of funds; functions and activities.
- 286. Same; construction and improvement of buildings and facilities.

§ 271. Bureau established.

The Office of Standard Weights and Measures shall be known as the National Bureau of Standards. (Mar. 3, 1901, ch. 872, § 1, 31 Stat. 1449.)

§ 272. Functions of Secretary.

The Secretary of Commerce (hereinafter referred to as the "Secretary") is authorized to undertake the following functions:

(a) The custody, maintenance, and development of the national standards of measurement, and the provision of means and methods for making measurements consistent with those standards, including the comparison of standards used in scientific investigations, engineering, manufacturing, commerce, and educational institutions with the standards adopted or recognized by the Government.

(b) The determination of physical constants and properties of materials when such data are of great importance to scientific or manufacturing interests and are not to be obtained of sufficient accuracy elsewhere.

(c) The development of methods for testing materials, mechanisms, and structures, and the testing of materials, supplies, and equipment, including items purchased for use of Government departments and independent establishments.

(d) Cooperation with other governmental agencies and with private organizations in the establishment of standard practices, incorporated in codes and specifications.

(e) Advisory service to Government agencies on scientific and technical problems.

(f) Invention and development of devices to serve special needs of the Government.

In carrying out the functions enumerated in this section, the Secretary is authorized to undertake the following activities and similar ones for which need may arise in the operations of Government agencies, scientific institutions, and industrial enterprises:

(1) the construction of physical standards;

(2) the testing, calibration, and certification of standards and standard measuring apparatus;

(3) the study and improvement of instruments and methods of measurements;

(4) the investigation and testing of railroad track scales, elevator scales, and other scales used in weighing commodities for interstate shipment;

(5) cooperation with the States in securing uniformity in weights and measures laws and methods of inspection;

(6) the preparation and distribution of standard samples such as those used in checking chemical analyses, temperature, color, viscosity, heat of combustion, and other basic properties of materials; also the preparation and sale or other distribution of standard instruments, apparatus and materials for calibration of measuring equipment;

(7) the development of methods of chemical analysis and synthesis of materials, and the investigation of the properties of rare substances;

(8) the study of methods of producing and of measuring high and low temperatures; and the behavior of materials at high and at low temperatures;

(9) the investigation of radiation, radioactive substances, and X-rays, their uses, and means of protection of persons from their harmful effects;

(10) the study of the atomic and molecular structure of the chemical elements, with particular reference to the characteristics of the spectra emitted, the use of spectral observations in determining chemical composition of materials, and the relation of molecular structure to the practical usefulness of materials;

(11) the broadcasting of radio signals of standard frequency;

(12) the investigation of the conditions which affect the transmission of radio waves from their source to a receiver;

(13) the compilation and distribution of information on such transmission of radio waves as a basis for choice of frequencies to be used in radio operations;

(14) the study of new technical processes and methods of fabrication of materials in which the Government has a special interest; also the study of methods of measurement and technical processes used in the manufacture of optical glass and pottery, brick, tile, terra cotta, and other clay products;

(15) the determination of properties of building materials and structural elements, and encouragement of their standardization and most effective use, including investigation of fire-resisting properties of building materials and conditions under which they may be most efficiently used, and the standardization of types of appliances for fire prevention;

(16) metallurgical research, including study of alloy steels and light metal alloys; investigation of foundry practice, casting, rolling, and forging; prevention of corrosion of metals and alloys; behavior of bearing metals; and development of standards for metals and sands;

(17) the operation of a laboratory of applied mathematics;

(18) the prosecution of such research in engineering, mathematics, and the physical sciences as may be necessary to obtain basic data pertinent to the functions specified herein; and

(19) the compilation and publication of general scientific and technical data resulting from the performance of the functions specified herein or from other sources when such data are of importance to scientific or manufacturing interests or to the general public, and are not available elsewhere, including demonstration of the results of the Bureau's work by exhibits or otherwise as may be deemed most effective. (Mar. 3, 1901, ch. 872, § 2, 31 Stat. 1449; July 22, 1950, ch. 486, § 1, 64 Stat. 371.)

§ 273. Functions; for whom exercised.

That the bureau shall exercise its functions for the Government of the United States; for any State or municipal government within the United States; or for any scientific society, educational institution, firm, corporation, or individual within the United States engaged in manufacturing or other pursuits requiring the use of standards or standard measuring instruments. All requests for the services of the bureau shall be made in accordance with the rules and regulations herein established in sections 276 and 277 of this title. (Mar. 3, 1901, ch. 872, § 3, 31 Stat. 1449.)

§ 274. Director; powers and duties; report.

The director shall be appointed by the President, by and with the advice and consent of the Senate. He shall have the general supervision of the bureau, its equipment, and the exercise of its functions. He shall make an annual report to the Secretary of Commerce, including an abstract of the work done during the year and a financial statement. He may issue, when necessary, bulletins for public distribution, containing such information as may be of value to the public or facilitate the bureau in the exercise of its functions. (Mar. 3, 1901, ch. 872, § 5, 31 Stat. 1449; Feb. 14, 1903, ch. 552, § 10, 32 Stat. 829; Mar. 4, 1913, ch. 141, § 1, 37 Stat. 736.)

§ 275. Appointment of officers and employees.

The officers and employees of the bureau, except the director, shall be appointed by the Secretary of Commerce at such time as their respective services may become necessary. (Mar. 3, 1901, ch. 872, § 6, 31 Stat. 1450; Feb. 14, 1903, ch. 552, § 10, 32 Stat. 829; Mar. 4, 1913, ch. 141, § 1, 37 Stat. 736.)

§ 276. Fees.

For all comparisons, calibrations, tests, or investigations, performed by the National Bureau of Standards under sections 271—278c of this title, as amended and supplemented, except those performed for the Government of the United States or State governments within the United States, a fee sufficient in each case to compensate the National Bureau of Standards for the entire cost of the services rendered shall be charged, according to a schedule prepared by the Director of the National Bureau of Standards and approved by the Secretary of Commerce. All moneys received from such sources shall be paid into the Treasury to the credit of miscellaneous receipts. (Mar. 3, 1901, ch. 872, § 8, 31 Stat. 1450; Feb. 14, 1903, ch. 552, § 10, 32 Stat. 829; Mar. 4, 1913, ch. 141, § 1, 37 Stat. 736; June 30, 1932, ch. 314, § 312, 47 Stat. 410.)

§ 277. Regulations.

The Secretary of Commerce shall, from time to time, make regulations regarding the payment of fees, the limits of tolerance to be attained in standards submitted for verification, the sealing of standards, the disbursement and receipt of moneys, and such other matters as he may deem necessary for carrying this Act into effect sections 271—278c of this title. (Mar. 3, 1901, ch. 872, § 9, 31 Stat. 1450; Feb. 14, 1903, ch. 552, § 10, 32 Stat. 829; Mar. 4, 1913, ch. 141, § 1, 37 Stat. 736.)

§ 278. Visiting committee.

There shall be a visiting committee of five members, to be appointed by the Secretary of Commerce, to consist of men prominent in the various interests involved, and not in the employ of the Government. This committee shall visit the bureau at least once a year, and report to the Secretary of Commerce upon the efficiency of its scientific work and the condition of its equipment. The members of this committee shall serve without compensation, but shall be paid the actual expenses incurred in attending its meetings. The period of service of the members of the committee shall be so arranged that one member shall retire each year, and the appointments to be for a period of five years. Appointments made to fill vacancies occurring other than in the regular manner are to be made for the remainder of the period in which the vacancy exists. (Mar. 3, 1901, ch. 872, § 10, 31 Stat. 1450; Feb. 14, 1903, ch. 552, § 10, 32 Stat. 829; Mar. 4, 1913, ch. 141, § 1, 37 Stat. 736.)

§ 278a. Reimbursement from other Government agencies for services rendered.

For all services rendered for other Government agencies by the Secretary in the performance of functions specified in sections 271—278c of this title, the Department of Commerce may be reimbursed in accordance with section 606 of Title 31. (Mar. 3, 1901, ch. 872, § 11, as added July 22, 1950, ch. 486, § 2, 64 Stat. 371.)

§ 278b. Ownership of equipment transferred to carry out investigations.

In the absence of specific agreement to the contrary, equipment purchased by the Department of Commerce from transferred or advanced funds in order to carry out an investigation authorized in sections 271—278c of this title for another Government agency shall become the property of the Department of Commerce for use in subsequent investigations. (Mar. 3, 1901, ch. 872, § 12, as added July 22, 1950, ch. 486, § 2, 64 Stat. 371.)

§ 278c. Acceptance of gifts and bequests.

(a) The Secretary of Commerce is authorized to accept and utilize gifts or bequests of real or personal property for the purpose of aiding and facilitating the work authorized in sections 271—278c of this title.

(b) For the purpose of Federal income, estate, and gift taxes, gifts and bequests accepted by the Secretary of Commerce under the authority of sections 271—278c of this title shall be deemed to be gifts and bequests to or for the use of the United States. (Mar. 3, 1901, ch. 872, § 13, as added July 22, 1950, ch. 486, § 2, 64 Stat. 371.)

§ 279. Absence of Director.

In the case of the absence of the Director of the Bureau of Standards the Secretary of Commerce may designate some officer of said bureau to perform the duties of the director during his absence. (Mar. 4, 1911, ch. 237, § 1, 36 Stat. 1231; Mar. 4, 1913, ch. 141, § 1, 37 Stat. 736.)

§ 280. Apprentices; promotion.

Apprentices in the Bureau of Standards may be promoted after satisfactory apprenticeship, with the approval of the Civil Service Commission, to positions corresponding to the journeyman grades for which their duties logically prepare them, without regard to apportionment: *Provided*, That they thus acquire no rights to transfer to other lines of work. (July 16, 1914, ch. 141, § 1, 38 Stat. 502.)

§ 281. Testing materials for District of Columbia.

Materials for fireproof buildings, other structural materials, and all materials, other than materials for paving and for fuel, purchased for and to be used by the government of the District of Columbia, when necessary in the judgment of the commissioners to be tested, shall be tested by the Bureau of Standards under the same conditions as similar testing is required to be done for the United States Government. (Mar. 4, 1913, ch. 150, 37 Stat. 945.)

§ 282. National hydraulic laboratory; establishment; purpose; study of Federal and State projects.

There is authorized to be established in the Bureau of Standards of the Department of Commerce a national hydraulic laboratory for the determination of fundamental data useful in hydraulic research and engineering, including laboratory research relating to the behavior and control of river and harbor waters, the study of hydraulic structures and water flow, and the development and testing of hydraulic instruments and accessories; *Provided*, That no test, study, or other work on a problem or problems connected with a project the prosecution of which is under the jurisdiction of any department or independent agency of the Government shall be undertaken in the laboratory herein authorized until a written request to do such work is submitted to the Director of the Bureau of Standards by the head of the department or independent agency charged with the execution of such project: *And provided further*, That any State or political subdivision thereof may obtain a test, study, or other work on a problem connected with a project the prosecution of which is under the jurisdiction of such State or political subdivision thereof. (May 14, 1930, ch. 275, § 1, 46 Stat. 327.)

§§ 283, 284. Omitted.

§ 285. Availability of funds; functions and activities.

Funds now or hereafter appropriated to the National Bureau of Standards shall be available for the following activities: (a) The purchase, repair, and cleaning of uniforms for guards; (b) the repair and alteration of buildings, and other plant facilities; (c) the rental of laboratory and office space in the District of Columbia and in the field; (d) the purchase of reprints from trade journals or other periodicals of articles prepared officially by Government employees; (e) the furnishing of food and shelter without repayment therefor to employees of the Government at Arctic stations; and (f) in the conduct of observations on radio propagation phenomena in the Arctic region, the appointment of employees at base rates established by the Secretary of Commerce which shall not exceed such maximum rates as may be specified from time to time in the appropriation concerned, and without regard to the civil service and classification laws and sections 911—913, 921, and 922 of Title 5. (July 21, 1950, ch 485, § 1, 64 Stat. 370.)

§ 286. Same; construction and improvement of buildings and facilities.

Within the limits of funds which may be appropriated therefor, the Secretary of Commerce is authorized to make improvements to existing buildings, grounds, and other plant facilities, including construction of minor buildings and other facilities of the National Bureau of Standards in the District of Columbia and in the field to house special apparatus or material which must be isolated from other activities: *Provided*, That no improvement shall be made nor shall any building be constructed under this authority at a cost in excess of \$25,000, unless specific provision is made therefor in the appropriation concerned. (July 21, 1950, ch. 485, § 2, 64 Stat. 371.)

\* \* \* \* \*

Chapter 7.—THE BUREAU OF STANDARDS

Sec.

- 271. Bureau established.
- 272. Functions of Secretary.
- 273. Functions; for whom exercised.
- 274. Director; powers and duties; report.
- 275. Appointment of officers and employees.
- 275a. Service charges.
- 276. Ownership of facilities.
- 277. Regulations.
- 278. Visiting committee.
- 278a. Acceptance of gifts and bequests.
- 278b. Working Capital Fund.
  - (a) Utilization; appropriations.
  - (b) Availability of Fund.
  - (c) Reimbursements.
  - (d) Credits.
  - (e) Cost defined.
  - (f) Distribution of earnings; restoration of prior impairment.
- 278c. Acquisition of land for field sites.
- 278d. Construction and improvement of buildings and facilities.
- 278e. Functions and activities.
- 279. Absence of Director.
- 280. Apprentices; promotion.
- 281. Testing materials for District of Columbia.
- 282. National hydraulic laboratory; establishment; purpose; study of Federal and State projects.
- 283, 284. Omitted.
- 285, 286. Repealed.

§ 271. Bureau established.

The Office of Standard Weights and Measures shall be known as the National Bureau of Standards. (Mar. 3, 1901, ch. 872, § 1, 31 Stat. 1449.)

§ 272. Functions of Secretary.

The Secretary of Commerce (hereinafter referred to as the "Secretary") is authorized to undertake the following functions:

- (a) The custody, maintenance, and development of the national standards of measurement, and the provision of means and methods for making measurements consistent with those standards, including the comparison of standards used in scientific investigations, engineering, manufacturing, commerce, and educational institutions with the standards adopted or recognized by the Government.
- (b) The determination of physical constants and properties of materials when such data are of great importance to scientific or manufacturing interests and are not to be obtained of sufficient accuracy elsewhere.
- (c) The development of methods for testing materials, mechanisms, and structures, and the testing of materials, supplies, and equipment, including items purchased for use of Government departments and independent establishments.
- (d) Cooperation with other governmental agencies and with private organizations in the establishment of standard practices, incorporated in codes and specifications.
- (e) Advisory service to Government agencies on scientific and technical problems.
- (f) Invention and development of devices to serve special needs of the Government.

In carrying out the functions enumerated in this section, the Secretary is authorized to undertake the following activities and similar ones for which need may arise in the operations of Government agencies, scientific institutions, and industrial enterprises:

- (1) the construction of physical standards;
- (2) the testing, calibration, and certification of standards and standard measuring apparatus;
- (3) the study and improvement of instruments and methods of measurements;
- (4) the investigation and testing of railroad track scales, elevator scales, and other scales used in weighing commodities for interstate shipment;
- (5) cooperation with the States in securing uniformity in weights and measures laws and methods of inspection;
- (6) the preparation and distribution of standard samples such as those used in checking chemical analyses, temperature, color, viscosity, heat of combustion, and other basic properties of materials; also the preparation and sale or other distribution of standard instruments, apparatus and materials for calibration of measuring equipment;
- (7) the development of methods of chemical analysis and synthesis of materials, and the investigation of the properties of rare substances;
- (8) the study of methods of producing and of measuring high and low temperatures; and the behavior of materials at high and at low temperatures;
- (9) the investigation of radiation, radioactive substances, and X-rays, their uses, and means of protection of persons from their harmful effects;
- (10) the study of the atomic and molecular structure of the chemical elements, with particular reference to the characteristics of the spectra emitted, the use of spectral observations in determining chemical composition of materials, and the relation of molecular structure to the practical usefulness of materials;
- (11) the broadcasting of radio signals of standard frequency;
- (12) the investigation of the conditions which affect the transmission of radio waves from their source to a receiver;
- (13) the compilation and distribution of information on such transmission of radio waves as a basis for choice of frequencies to be used in radio operations;
- (14) the study of new technical processes and methods of fabrication of materials in which the Government has a special interest; also the study of methods of measurement and technical processes used in the manufacture of optical glass and pottery, brick, tile, terra cotta, and other clay products;
- (15) the determination of properties of building materials and structural elements, and encouragement of their standardization and most effective use, including investigation of fire-resisting properties of building materials and conditions under which they may be most efficiently used, and the standardization of types of appliances for fire prevention;
- (16) metallurgical research, including study of alloy steels and light metal alloys; investigation of foundry practice, casting, rolling, and forging; prevention of corrosion of metals and alloys; behavior of bearing metals; and development of standards for metals and sands;
- (17) the operation of a laboratory of applied mathematics;
- (18) the prosecution of such research in engineering, mathematics, and the physical sciences as may be necessary to obtain basic data pertinent to the functions specified herein; and
- (19) the compilation and publication of general scientific and technical data resulting from the performance of the functions specified herein or from other sources when such data are of importance to scientific or manufacturing interests or to the general public, and are not available elsewhere, including demonstration of the results of the Bureau's work by exhibits or otherwise as may be deemed most effective. (Mar. 3, 1901, ch. 872, § 2, 31 Stat. 1449; July 22, 1950, ch. 486, § 1, 64 Stat. 371.)

§ 273. Functions; for whom exercised.

That the bureau shall exercise its functions for the Government of the United States; for any State or municipal government within the United States; or for any scientific society, educational institution, firm, corporation, or individual within the United States engaged in manufacturing or other pursuits requiring the use of standards or standard measuring instruments. All requests for the services of the bureau shall be made in accordance with the rules and regulations herein established in sections 276 and 277 of this title. (Mar. 3, 1901, ch. 872, § 3, 31 Stat. 1449.)

§ 274. Director; powers and duties; report.

The director shall be appointed by the President, by and with the advice and consent of the Senate. He shall have the general supervision of the bureau, its equipment, and the exercise of its functions. He shall make an annual report to the Secretary of Commerce, including an abstract of the work done during the year and a financial statement. He may issue, when necessary, bulletins for public distribution, containing such information as may be of value to the public or facilitate the bureau in the exercise of its functions. (Mar. 3, 1901, ch. 872, § 5, 31 Stat. 1449; Feb. 14, 1903, ch. 552, § 10, 32 Stat. 829; Mar. 4, 1913, ch. 141, § 1, 37 Stat. 736.)

§ 275. Appointment of officers and employees.

The officers and employees of the bureau, except the director, shall be appointed by the Secretary of Commerce at such time as their respective services may become necessary. (Mar. 3, 1901, ch. 872, § 6, 31 Stat. 1450; Feb. 14, 1903, ch. 552, § 10, 32 Stat. 829; Mar. 4, 1913, ch. 141, § 1, 37 Stat. 736.)

§ 275a. Service charges.

The Secretary shall charge for services performed under the authority of section 273 of this title, except in cases where he determines that the interest of the Government would be best served by waiving the charge. Such charges may be based upon fixed prices or costs. The appropriation or fund bearing the cost of the services may be reimbursed, or the Secretary may require advance payment subject to such adjustment on completion of the work as may be agreed upon. (Mar. 3, 1901, ch. 872, § 7, as added Aug. 3, 1956, ch. 906, § 1, 70 Stat. 959.)

§ 276. Ownership of facilities.

In the absence of specific agreement to the contrary, additional facilities, including equipment, purchased pursuant to the performance of services authorized by section 273 of this title shall become the property of the Department of Commerce. (Mar. 3, 1901, ch. 872, § 8, 31 Stat. 1450; Feb. 14, 1903, ch. 552, § 10, 32 Stat. 829; Mar. 4, 1913, ch. 141, § 1, 37 Stat. 736; June 30, 1932, ch. 314, § 312, 47 Stat. 410; Aug. 3, 1956, ch. 906, § 1, 70 Stat. 959.)

§ 277. Regulations.

The Secretary of Commerce shall, from time to time, make regulations regarding the payment of fees, the limits of tolerance to be attained in standards submitted for verification, the sealing of standards, the disbursement and receipt of moneys, and such other matters as he may deem necessary for carrying this Act into effect sections 271—278b of this title. (Mar. 3, 1901, ch. 872, § 9, 31 Stat. 1450; Feb. 14, 1903, ch. 552, § 10, 32 Stat. 829; Mar. 4, 1913, ch. 141, § 1, 37 Stat. 736.)

§ 278. Visiting committee.

There shall be a visiting committee of five members, to be appointed by the Secretary of Commerce, to consist of men prominent in the various interests involved, and not in the employ of the Government. This committee shall visit the bureau at least once a year, and report to the Secretary of Commerce upon the efficiency of its scientific work and the condition of its equipment. The members of this committee shall serve without compensation, but shall be paid the actual expenses incurred in attending its meetings. The period of service of the members of the committee shall be so arranged that one member shall retire each year, and the appointments to be for a period of five years. Appointments made to fill vacancies occurring other than in the regular manner are to be made for the remainder of the period in which the vacancy exists. (Mar. 3, 1901, ch. 872, § 10, 31 Stat. 1450; Feb. 14, 1903, ch. 552, § 10, 32 Stat. 829; Mar. 4, 1913, ch. 141, § 1, 37 Stat. 736.)

§ 278a. Acceptance of gifts and bequests.

(a) The Secretary of Commerce is authorized to accept and utilize gifts or bequests of real or personal property for the purpose of aiding and facilitating the work authorized herein.

(b) For the purpose of Federal income, estate, and gift taxes, gifts and bequests accepted by the Secretary of Commerce under the authority of sections 271-278b of this title shall be deemed to be gifts and bequests to or for the use of the United States. (Mar. 3, 1901, ch. 872, § 11, as added July 22, 1950, ch. 486, § 2, 64 Stat. 371, and amended Aug. 3, 1956, ch. 906, § 2, 70 Stat. 959; Sept. 2, 1958, Pub. L. 85-890, § 2, 72 Stat. 1712.)



§ 278b. Working Capital Fund.

(a) Utilization; appropriations.

The National Bureau of Standards is authorized to utilize in the performance of its functions the Working Capital Fund established by the Act of June 29, 1950 (64 Stat. 275), and additional amounts as from time to time may be required for the purposes of said fund are authorized to be appropriated.

(b) Availability of Fund.

The working capital of the fund shall be available for obligation and payment for any activities authorized by sections 271-278b of this title, and for any activities for which provision is made in the appropriations which reimburse the fund.

(c) Reimbursements.

In the performance of authorized activities, the Working Capital Fund shall be available and may be reimbursed for expenses of hire of automobile, hire of consultants, and travel to meetings, to the extent that such expenses are authorized for the appropriations of the Department of Commerce.

(d) Credits.

The fund may be credited with advances and reimbursement, including receipts from non-Federal sources, for services performed under the authority of section 273 of this title.

(e) Cost defined.

As used in sections 271-278b of this title, the term "cost" shall be construed to include directly related expenses and appropriate charges for indirect and administrative expenses.

(f) Distribution of earnings; restoration of prior impairment.

The amount of any earned net income resulting from the operation of the fund at the close of each fiscal year shall be paid into the general fund of the Treasury: *Provided*, That such earned net income may be applied first to restore any prior impairment of the fund. (Mar. 3, 1901, ch. 872, § 12, as added July 22, 1950, ch. 486, § 2, 64 Stat. 371, and amended Aug. 3, 1956, ch. 906, § 2, 70 Stat. 959.)

§ 278c. Acquisition of land for field sites.

To the extent that funds are specifically appropriated therefor, the Secretary of Commerce is authorized to acquire land for such field sites as are necessary for the proper and efficient conduct of the activities authorized herein. (Mar. 3, 1901, ch. 872, § 13, as added Sept. 2, 1958, Pub. L. 85-890, § 1, 72 Stat. 1711.)

§ 278d. Construction and improvement of buildings and facilities.

Within the limits of funds which are appropriated for the National Bureau of Standards, the Secretary of Commerce is authorized to undertake such construction of buildings and other facilities and to make such improvements to existing buildings, grounds, and other facilities occupied or used by the National Bureau of Standards as are necessary for the proper and efficient conduct of the activities authorized herein: *Provided*, That no improvement shall be made nor shall any building be constructed under this authority at a cost in excess of \$40,000 unless specific provision is made therefor in the appropriation concerned. (Mar. 3, 1901, ch. 872, § 14, as added Sept. 2, 1958, Pub. L. 85-890, § 1, 72 Stat. 1711.)

§ 278e. Functions and activities.

In the performance of the functions of the National Bureau of Standards and the Secretary of Commerce is authorized to undertake the following activities: (a) The purchase, repair, and cleaning of uniforms for guards; (b) the repair and alteration of buildings and other plant facilities; (c) the rental of field sites and laboratory, office, and warehouse space; (d) the purchase of reprints from technical journals or other periodicals and the payment of page charges for the publication of research papers and reports in such journals; (e) the furnishing of food and shelter without repayment therefor to employees of the Government at Arctic and Antarctic stations; (f) for the conduct of observations on radio propagation phenomena in the Arctic or Antarctic regions, the appointment of employees at base rates established by the Secretary of Commerce which shall not exceed such maximum rates as may be specified from time to time in the appropriation concerned, and without regard to the civil service and classification laws and sections 911-913, 921, and 922 of Title 5; and (g) the erection on leased property of specialized facilities and working and living quarters when the Secretary of Commerce determines that this will best serve the interests of the Government. (Mar. 3, 1901, ch. 872, § 15, as added Sept. 2, 1958, Pub. L. 85-890, § 1, 72 Stat. 1711.)

§ 279. Absence of Director.

In the case of the absence of the Director of the Bureau of Standards the Secretary of Commerce may designate some officer of said bureau to perform the duties of the director during his absence. (Mar. 4, 1911, ch. 237, § 1, 36 Stat. 1231; Mar. 4, 1913, ch. 141, § 1, 37 Stat. 736.)

§ 280. Apprentices; promotion.

Apprentices in the Bureau of Standards may be promoted after satisfactory apprenticeship, with the approval of the Civil Service Commission, to positions corresponding to the journeyman grades for which their duties logically prepare them, without regard to apportionment: *Provided*, That they thus acquire no rights to transfer to other lines of work. (July 16, 1914, ch. 141, § 1, 38 Stat. 502.)

§ 281. Testing materials for District of Columbia.

Materials for fireproof buildings, other structural materials, and all materials, other than materials for paving and for fuel, purchased for and to be used by the government of the District of Columbia, when necessary in the judgment of the commissioners to be tested, shall be tested by the Bureau of Standards under the same conditions as similar testing is required to be done for the United States Government. (Mar. 4, 1913, ch. 150, 37 Stat. 945.)

§ 282. National hydraulic laboratory; establishment; purpose; study of Federal and State projects.

There is authorized to be established in the Bureau of Standards of the Department of Commerce a national hydraulic laboratory for the determination of fundamental data useful in hydraulic research and engineering, including laboratory research relating to the behavior and control of river and harbor waters, the study of hydraulic structures and water flow, and the development and testing of hydraulic instruments and accessories; *Provided*, That no test, study, or other work on a problem or problems connected with a project the prosecution of which is under the jurisdiction of any department or independent agency of the Government shall be undertaken in the laboratory herein authorized until a written request to do such work is submitted to the Director of the Bureau of Standards by the head of the department or independent agency charged with the execution of such project: *And provided further*, That any State or political subdivision thereof may obtain a test, study, or other work on a problem connected with a project the prosecution of which is under the jurisdiction of such State or political subdivision thereof. (May 14, 1930, ch. 275, § 1, 46 Stat. 327.)

§ 283, 284. Omitted.

§ 285, 286. Repealed. Pub. L. 85-890, 3, Sept. 2, 1958, 72 Stat. 1712.

From the *United States Code, 1964 edition, Containing the General and Permanent Laws of the United States, in Force on January 3, 1965*, pp. 2824-2829.

Chapter 7.—THE BUREAU OF STANDARDS

Sec.

- 271. Bureau established.
- 272. Functions of Secretary.
- 273. Functions; for whom exercised.
- 274. Director; powers and duties; report.
- 275. Appointment of officers and employees.
- 275a. Service charges.
- 276. Ownership of facilities.
- 277. Regulations.
- 278. Visiting committee.
- 278a. Repealed
- 278b. Working Capital Fund.
  - (a) Utilization; appropriations.
  - (b) Availability of Fund.
  - (c) Reimbursements.
  - (d) Credits.
  - (e) Cost defined.
  - (f) Distribution of earnings; restoration of prior impairment.
- 278c. Acquisition of land for field sites.
- 278d. Construction and improvement of buildings and facilities.
- 278e. Functions and activities.
- 279. Absence of Director.
- 280. Apprentices; promotion.
- 281. Testing materials for District of Columbia.
- 282. National hydraulic laboratory; establishment; purpose; study of Federal and State projects.
- 283, 284. Omitted.
- 285, 286. Repealed.

§ 271. Bureau established.

The Office of Standard Weights and Measures shall be known as the National Bureau of Standards.  
(Mar. 3, 1901, ch. 872, § 1, 31 Stat. 1449.)

§ 272. Functions of Secretary.

The Secretary of Commerce (hereinafter referred to as the "Secretary") is authorized to undertake the following functions:

(a) The custody, maintenance, and development of the national standards of measurement, and the provision of means and methods for making measurements consistent with those standards, including the comparison of standards used in scientific investigations, engineering, manufacturing, commerce, and educational institutions with the standards adopted or recognized by the Government.

(b) The determination of physical constants and properties of materials when such data are of great importance to scientific or manufacturing interests and are not to be obtained of sufficient accuracy elsewhere.

(c) The development of methods for testing materials, mechanisms, and structures, and the testing of materials, supplies, and equipment, including items purchased for use of Government departments and independent establishments.

(d) Cooperation with other governmental agencies and with private organizations in the establishment of standard practices, incorporated in codes and specifications.

(e) Advisory service to Government agencies on scientific and technical problems.

(f) Invention and development of devices to serve special needs of the Government.

In carrying out the functions enumerated in this section, the Secretary is authorized to undertake the following activities and similar ones for which need may arise in the operations of Government agencies, scientific institutions, and industrial enterprises:

- (1) the construction of physical standards;
- (2) the testing, calibration, and certification of standards and standard measuring apparatus;
- (3) the study and improvement of instruments and methods of measurements;
- (4) the investigation and testing of railroad track scales, elevator scales, and other scales used in weighing commodities for interstate shipment;
- (5) cooperation with the States in securing uniformity in weights and measures laws and methods of inspection;
- (6) the preparation and distribution of standard samples such as those used in checking chemical analyses, temperature, color, viscosity, heat of combustion, and other basic properties of materials; also the preparation and sale or other distribution of standard instruments, apparatus and materials for calibration of measuring equipment;
- (7) the development of methods of chemical analysis and synthesis of materials, and the investigation of the properties of rare substances;
- (8) the study of methods of producing and of measuring high and low temperatures; and the behavior of materials at high and at low temperatures;
- (9) the investigation of radiation, radioactive substances, and X-rays, their uses, and means of protection of persons from their harmful effects;
- (10) the study of the atomic and molecular structure of the chemical elements, with particular reference to the characteristics of the spectra emitted, the use of spectral observations in determining chemical composition of materials, and the relation of molecular structure to the practical usefulness of materials;
- (11) the broadcasting of radio signals of standard frequency;
- (12) the investigation of the conditions which affect the transmission of radio waves from their source to a receiver;
- (13) the compilation and distribution of information on such transmission of radio waves as a basis for choice of frequencies to be used in radio operations;
- (14) the study of new technical processes and methods of fabrication of materials in which the Government has a special interest; also the study of methods of measurement and technical processes used in the manufacture of optical glass and pottery, brick, tile, terra cotta, and other clay products;
- (15) the determination of properties of building materials and structural elements, and encouragement of their standardization and most effective use, including investigation of fire-resisting properties of building materials and conditions under which they may be most efficiently used, and the standardization of types of appliances for fire protection;
- (16) metallurgical research, including study of alloy steels and light metal alloys; investigation of foundry practice, casting, rolling, and forging; prevention of corrosion of metals and alloys; behavior of bearing metals; and development of standards for metals and sands;
- (17) the operation of a laboratory of applied mathematics;
- (18) the prosecution of such research in engineering, mathematics, and the physical sciences as may be necessary to obtain basic data pertinent to the functions specified herein; and
- (19) the compilation and publication of general scientific and technical data resulting from the performance of the functions specified herein or from other sources when such data are of importance to scientific or manufacturing interests or to the general public, and are not available elsewhere, including demonstration of the results of the Bureau's work by exhibits or otherwise as may be deemed most effective. (Mar. 3, 1901, ch. 872, § 2, 31 Stat. 1449; July 22, 1950, ch. 486, § 1, 64 Stat. 371.)

§ 273. Functions; for whom exercised.

That the bureau shall exercise its functions for the Government of the United States; for any State or municipal government within the United States; or for any scientific society, educational institution, firm, corporation, or individual within the United States engaged in manufacturing or other pursuits requiring the use of standards or standard measuring instruments. All requests for the services of the bureau shall be made in accordance with the rules and regulations herein established in sections 276 and 277 of this title. (Mar. 3, 1901, ch. 872, § 3, 31 Stat. 1449.)

§ 274. Director; powers and duties; report.

The director shall be appointed by the President, by and with the advice and consent of the Senate. He shall have the general supervision of the bureau, its equipment, and the exercise of its functions. He shall make an annual report to the Secretary of Commerce, including an abstract of the work done during the year and a financial statement. He may issue, when necessary, bulletins for public distribution, containing such information as may be of value to the public or facilitate the bureau in the exercise of its functions. (Mar. 3, 1901, ch. 872, § 5, 31 Stat. 1449; Feb. 14, 1903, ch. 552, § 10, 32 Stat. 829; Mar. 4, 1913, ch. 141, § 1, 37 Stat. 736.)

§ 275. Appointment of officers and employees.

The officers and employees of the bureau, except the director, shall be appointed by the Secretary of Commerce at such time as their respective services may become necessary. (Mar. 3, 1901, ch. 872, § 6, 31 Stat. 1450; Feb. 14, 1903, ch. 552, § 10, 32 Stat. 829; Mar. 4, 1913, ch. 141, § 1, 37 Stat. 736.)

§ 275a. Service charges.

The Secretary shall charge for services performed under the authority of section 273 of this title, except in cases where he determines that the interest of the Government would be best served by waiving the charge. Such charges may be based upon fixed prices or costs. The appropriation or fund bearing the cost of the services may be reimbursed, or the Secretary may require advance payment subject to such adjustment on completion of the work as may be agreed upon. (Mar. 3, 1901, ch. 872, § 7, as added Aug. 3, 1956, ch. 906, § 1, 70 Stat. 959.)

§ 276. Ownership of facilities.

In the absence of specific agreement to the contrary, additional facilities, including equipment, purchased pursuant to the performance of services authorized by section 273 of this title shall become the property of the Department of Commerce. (Mar. 3, 1901, ch. 872, § 8, 31 Stat. 1450; Feb. 14, 1903, ch. 552, § 10, 32 Stat. 829; Mar. 4, 1913, ch. 141, § 1, 37 Stat. 736; June 30, 1932, ch. 314, § 312, 47 Stat. 410; Aug. 3, 1956, ch. 906, § 1, 70 Stat. 959.)

§ 277. Regulations.

The Secretary of Commerce shall, from time to time, make regulations regarding the payment of fees, the limits of tolerance to be attained in standards submitted for verification, the sealing of standards, the disbursement and receipt of moneys, and such other matters as he may deem necessary for carrying this Act into effect sections 271—278e of this title. (Mar. 3, 1901, ch. 872, § 9, 31 Stat. 1450; Feb. 14, 1903, ch. 552, § 10, 32 Stat. 829; Mar. 4, 1913, ch. 141, § 1, 37 Stat. 736.)

§ 278. Visiting committee.

There shall be a visiting committee of five members, to be appointed by the Secretary of Commerce, to consist of men prominent in the various interests involved, and not in the employ of the Government. This committee shall visit the bureau at least once a year, and report to the Secretary of Commerce upon the efficiency of its scientific work and the condition of its equipment. The members of this committee shall serve without compensation, but shall be paid the actual expenses incurred in attending its meetings. The period of service of the members of the committee shall be so arranged that one member shall retire each year, and the appointments to be for a period of five years. Appointments made to fill vacancies occurring other than in the regular manner are to be made for the remainder of the period in which the vacancy exists. (Mar. 3, 1901, ch. 872, § 10, 31 Stat. 1450; Feb. 14, 1903, ch. 552, § 10, 32 Stat. 829; Mar. 4, 1913, ch. 141, § 1, 37 Stat. 736.)

§ 278a. Repealed. Pub. L. 88-611, § 4 (a)(1), Oct. 2, 1964, 78 Stat. 991.

§ 278b. Working Capital Fund.

(a) Utilization; appropriations.

The National Bureau of Standards is authorized to utilize in the performance of its functions the Working Capital Fund established by the Act of June 29, 1950 (64 Stat. 275), and additional amounts as from time to time may be required for the purposes of said fund are authorized to be appropriated.

(b) Availability of Fund.

The working capital of the fund shall be available for obligation and payment for any activities authorized by sections 271-278e of this title, and for any activities for which provision is made in the appropriations which reimburse the fund.

(c) Reimbursements.

In the performance of authorized activities, the Working Capital Fund shall be available and may be reimbursed for expenses of hire of automobile, hire of consultants, and travel to meetings, to the extent that such expenses are authorized for the appropriations of the Department of Commerce.

(d) Credits.

The fund may be credited with advances and reimbursement, including receipts from non-Federal sources, for services performed under the authority of section 273 of this title.

(e) Cost defined.

As used in sections 271-278e of this title, the term "cost" shall be construed to include directly related expenses and appropriate charges for indirect and administrative expenses.

(f) Distribution of earnings; restoration of prior impairment.

The amount of any earned net income resulting from the operation of the fund at the close of each fiscal year shall be paid into the general fund of the Treasury: *Provided*, That such earned net income may be applied first to restore any prior impairment of the fund. (Mar. 3, 1901, ch. 872, § 12, as added July 22, 1950, ch. 486, § 2, 64 Stat. 371, and amended Aug. 3, 1956, ch. 906, § 2, 70 Stat. 959.)

§ 278c. Acquisition of land for field sites.

To the extent that funds are specifically appropriated therefor, the Secretary of Commerce is authorized to acquire land for such field sites as are necessary for the proper and efficient conduct of the activities authorized herein. (Mar. 3, 1901, ch. 872, § 13, as added Sept. 2, 1958, Pub. L. 85-890, § 1, 72 Stat. 1711.)

§ 278d. Construction and improvement of buildings and facilities.

Within the limits of funds which are appropriated for the National Bureau of Standards, the Secretary of Commerce is authorized to undertake such construction of buildings and other facilities and to make such improvements to existing buildings, grounds, and other facilities occupied or used by the National Bureau of Standards as are necessary for the proper and efficient conduct of the activities authorized herein: *Provided*, That no improvement shall be made nor shall any building be constructed under this authority at a cost in excess of \$40,000 unless specific provision is made therefor in the appropriation concerned. (Mar. 3, 1901, ch. 872, § 14, as added Sept. 2, 1958, Pub. L. 85-890, § 1, 72 Stat. 1711.)

§ 278e. Functions and activities.

In the performance of the functions of the National Bureau of Standards and the Secretary of Commerce is authorized to undertake the following activities: (a) The purchase, repair, and cleaning of uniforms for guards; (b) the repair and alteration of buildings and other plant facilities; (c) the rental of field sites and laboratory, office, and warehouse space; (d) the purchase of reprints from technical journals or other periodicals and the payment of page charges for the publication of research papers and reports in such journals; (e) the furnishing of food and shelter without repayment therefor to employees of the Government at Arctic and Antarctic stations; (f) for the conduct of observations on radio propagation phenomena in the Arctic or Antarctic regions, the appointment of employees at base rates established by the Secretary of Commerce which shall not exceed such maximum rates as may be specified from time to time in the appropriation concerned, and without regard to the civil service and classification laws and sections 911-913, 921, and 922 of Title 5; and (g) the erection on leased property of specialized facilities and working and living quarters when the Secretary of Commerce determines that this will best serve the interests of the Government. (Mar. 3, 1901, ch. 872, § 15, as added Sept. 2, 1958, Pub. L. 85-890, § 1, 72 Stat. 1711.)

§ 279. Absence of Director.

In the case of the absence of the Director of the Bureau of Standards the Secretary of Commerce may designate some officer of said bureau to perform the duties of the director during his absence. (Mar. 4, 1911, ch. 237, § 1, 36 Stat. 1231; Mar. 4, 1913, ch. 141, § 1, 37 Stat. 736.)

§ 280. Apprentices; promotion.

Apprentices in the Bureau of Standards may be promoted after satisfactory apprenticeship, with the approval of the Civil Service Commission, to positions corresponding to the journeyman grades for which their duties logically prepare them, without regard to apportionment: *Provided*, That they thus acquire no rights to transfer to other lines of work. (July 16, 1914, ch. 141, § 1, 38 Stat. 502.)

§ 281. Testing materials for District of Columbia.

Materials for fireproof buildings, other structural materials, and all materials, other than materials for paving and for fuel, purchased for and to be used by the government of the District of Columbia, when necessary in the judgment of the commissioners to be tested, shall be tested by the Bureau of Standards under the same conditions as similar testing is required to be done for the United States Government. (Mar. 4, 1913, ch. 150, 37 Stat. 945.)

§ 282. National hydraulic laboratory; establishment; purpose; study of Federal and State projects.

There is authorized to be established in the Bureau of Standards of the Department of Commerce a national hydraulic laboratory for the determination of fundamental data useful in hydraulic research and engineering, including laboratory research relating to the behavior and control of river and harbor waters, the study of hydraulic structures and water flow, and the development and testing of hydraulic instruments and accessories; *Provided*, That no test, study, or other work on a problem or problems connected with a project the prosecution of which is under the jurisdiction of any department or independent agency of the Government shall be undertaken in the laboratory herein authorized until a written request to do such work is submitted to the Director of the Bureau of Standards by the head of the department or independent agency charged with the execution of such project: *And provided further*, That any State or political subdivision thereof may obtain a test, study, or other work on a problem connected with a project the prosecution of which is under the jurisdiction of such State or political subdivision thereof. (May 14, 1930, ch. 275, § 1, 46 Stat. 327.)

§ 283, 284. Omitted.

§ 285, 286. Repealed. Pub. L. 85-890, 3, Sept. 2, 1958, 72 Stat. 1712.

\* \* \* \* \*

From the *United States Code, 1970 edition, Containing the General and Permanent Laws of the United States, in Force on January 20, 1971*, pp. 3231-3240.

Chapter 7.—THE BUREAU OF STANDARDS

Sec.

- 271. Bureau established.
- 272. Functions of Secretary.
- 273. Functions; for whom exercised.
- 274. Director; powers and duties; report.
- 275. Appointment of officers and employees.
- 275a. Service charges.
- 276. Ownership of facilities.
- 277. Regulations.
- 278. Visiting committee.
- 278a. Repealed
- 278b. Working Capital Fund.
  - (a) Utilization; appropriations.
  - (b) Availability of Fund.
  - (c) Reimbursements.
  - (d) Credits.
  - (e) Cost defined.
  - (f) Distribution of earnings; restoration of prior impairment.
- 278c. Acquisition of land for field sites.
- 278d. Construction and improvement of buildings and facilities.
- 278e. Functions and activities.
- 278f. Fire research and safety program; functions of Secretary of Commerce.
  - (a) Investigations for determination of pertinent factors; prevention, control, and reduction of effects, methods and techniques; educational programs; fire information reference services; demonstration projects.
  - (b) Engineering or science curriculums; instructional materials and aids. 278g. Same; general provisions.
  - (a) Eligibility for grants; amount; conditions; definitions.
  - (b) Reimbursement of Federal agencies; delegation of powers.
  - (c) Advances of public moneys.
  - (d) Cooperation of Federal agencies.
  - (e) Administration of functions; rules and regulations.
- 279. Absence of Director.
- 280. Apprentices; promotion.
- 281. Testing materials for District of Columbia.
- 282. National hydraulic laboratory; establishment; purpose; study of Federal and State projects.
- 283. Repealed
- 284. Transfer of materials, supplies, and equipment to Bureau for Arctic ionosphere observation by Departments of Army, Navy, and Air Force.
- 285, 286. Repealed.

§ 271. Bureau established.

The Office of Standard Weights and Measures shall be known as the National Bureau of Standards. (Mar. 3, 1901, ch. 872, § 1, 31 Stat. 1449.)

§ 272. Functions of Secretary.

The Secretary of Commerce (hereinafter referred to as the "Secretary") is authorized to undertake the following functions:



(a) The custody, maintenance, and development of the national standards of measurement, and the provision of means and methods for making measurements consistent with those standards, including the comparison of standards used in scientific investigations, engineering, manufacturing, commerce, and educational institutions with the standards adopted or recognized by the Government.

(b) The determination of physical constants and properties of materials when such data are of great importance to scientific or manufacturing interests and are not to be obtained of sufficient accuracy elsewhere.

(c) The development of methods for testing materials, mechanisms, and structures, and the testing of materials, supplies, and equipment, including items purchased for use of Government departments and independent establishments.

(d) Cooperation with other governmental agencies and with private organizations in the establishment of standard practices, incorporated in codes and specifications.

(e) Advisory service to Government agencies on scientific and technical problems.

(f) Invention and development of devices to serve special needs of the Government.

In carrying out the functions enumerated in this section, the Secretary is authorized to undertake the following activities and similar ones for which need may arise in the operations of Government agencies, scientific institutions, and industrial enterprises:

(1) the construction of physical standards;

(2) the testing, calibration, and certification of standards and standard measuring apparatus;

(3) the study and improvement of instruments and methods of measurements;

(4) the investigation and testing of railroad track scales, elevator scales, and other scales used in weighing commodities for interstate shipment;

(5) cooperation with the States in securing uniformity in weights and measures laws and methods of inspection;

(6) the preparation and distribution of standard samples such as those used in checking chemical analyses, temperature, color, viscosity, heat of combustion, and other basic properties of materials; also the preparation and sale or other distribution of standard instruments, apparatus and materials for calibration of measuring equipment;

(7) the development of methods of chemical analysis and synthesis of materials, and the investigation of the properties of rare substances;

(8) the study of methods of producing and of measuring high and low temperatures; and the behavior of materials at high and at low temperatures;

(9) the investigation of radiation, radioactive substances, and X-rays, their uses, and means of protection of persons from their harmful effects;

(10) the study of the atomic and molecular structure of the chemical elements, with particular reference to the characteristics of the spectra emitted, the use of spectral observations in determining chemical composition of materials, and the relation of molecular structure to the practical usefulness of materials;

(11) the broadcasting of radio signals of standard frequency;

(12) the investigation of the conditions which affect the transmission of radio waves from their source to a receiver;

(13) the compilation and distribution of information on such transmission of radio waves as a basis for choice of frequencies to be used in radio operations;

(14) the study of new technical processes and methods of fabrication of materials in which the Government has a special interest; also the study of methods of measurement and technical processes used in the manufacture of optical glass and pottery, brick, tile, terra cotta, and other clay products;

(15) the determination of properties of building materials and structural elements, and encouragement of their standardization and most effective use, including investigation of fire-resisting properties of building materials and conditions under which they may be most efficiently used, and the standardization of types of appliances for fire prevention;

(16) metallurgical research, including study of alloy steels and light metal alloys; investigation of foundry practice, casting, rolling, and forging; prevention of corrosion of metals and alloys; behavior of bearing metals; and development of standards for metals and sands;

(17) the operation of a laboratory of applied mathematics;

(18) the prosecution of such research in engineering, mathematics, and the physical sciences as may be necessary to obtain basic data pertinent to the functions specified herein; and

(19) the compilation and publication of general scientific and technical data resulting from the performance of the functions specified herein or from other sources when such data are of importance to scientific or manufacturing interests or to the general public, and are not available elsewhere, including demonstration of the results of the Bureau's work by exhibits or otherwise as may be deemed most effective. (Mar. 3, 1901, ch. 872, § 2, 31 Stat. 1449; July 22, 1950, ch. 486, § 1, 64 Stat. 371.)

§ 273. Functions; for whom exercised.

That the bureau shall exercise its functions for the Government of the United States; for any State or municipal government within the United States; or for any scientific society, educational institution, firm, corporation, or individual within the United States engaged in manufacturing or other pursuits requiring the use of standards or standard measuring instruments. All requests for the services of the bureau shall be made in accordance with the rules and regulations herein established in sections 276 and 277 of this title. (Mar. 3, 1901, ch. 872, § 3, 31 Stat. 1449.)

§ 274. Director; powers and duties; report.

The director shall be appointed by the President, by and with the advice and consent of the Senate. He shall have the general supervision of the bureau, its equipment, and the exercise of its functions. He shall make an annual report to the Secretary of Commerce, including an abstract of the work done during the year and a financial statement. He may issue, when necessary, bulletins for public distribution, containing such information as may be of value to the public or facilitate the bureau in the exercise of its functions. (Mar. 3, 1901, ch. 872, § 5, 31 Stat. 1449; Feb. 14, 1903, ch. 552, § 10, 32 Stat. 829; Mar. 4, 1913, ch. 141, § 1, 37 Stat. 736.)

§ 275. Appointment of officers and employees.

The officers and employees of the bureau, except the director, shall be appointed by the Secretary of Commerce at such time as their respective services may become necessary. (Mar. 3, 1901, ch. 872, § 6, 31 Stat. 1450; Feb. 14, 1903, ch. 552, § 10, 32 Stat. 829; Mar. 4, 1913, ch. 141, § 1, 37 Stat. 736.)

§ 275a. Service charges.

The Secretary shall charge for services performed under the authority of section 273 of this title, except in cases where he determines that the interest of the Government would be best served by waiving the charge. Such charges may be based upon fixed prices or costs. The appropriation or fund bearing the cost of the services may be reimbursed, or the Secretary may require advance payment subject to such adjustment on completion of the work as may be agreed upon. (Mar. 3, 1901, ch. 872, § 7, as added Aug. 3, 1956, ch. 906, § 1, 70 Stat. 959.)

§ 276. Ownership of facilities.

In the absence of specific agreement to the contrary, additional facilities, including equipment, purchased pursuant to the performance of services authorized by section 273 of this title shall become the property of the Department of Commerce. (Mar. 3, 1901, ch. 872, § 8, 31 Stat. 1450; Feb. 14, 1903, ch. 552, § 10, 32 Stat. 829; Mar. 4, 1913, ch. 141, § 1, 37 Stat. 736; June 30, 1932, ch. 314, § 312, 47 Stat. 410; Aug. 3, 1956, ch. 906, § 1, 70 Stat. 959.)

§ 277. Regulations.

The Secretary of Commerce shall, from time to time, make regulations regarding the payment of fees, the limits of tolerance to be attained in standards submitted for verification, the sealing of standards, the disbursement and receipt of moneys, and such other matters as he may deem necessary for carrying this Act into effect sections 271—278e of this title. (Mar. 3, 1901, ch. 872, § 9, 31 Stat. 1450; Feb. 14, 1903, ch. 552, § 10, 32 Stat. 829; Mar. 4, 1913, ch. 141, § 1, 37 Stat. 736.)

§ 278. Visiting committee.

There shall be a visiting committee of five members, to be appointed by the Secretary of Commerce, to consist of men prominent in the various interests involved, and not in the employ of the Government. This committee shall visit the bureau at least once a year, and report to the Secretary of Commerce upon the efficiency of its scientific work and the condition of its equipment. The members of this committee shall serve without compensation, but shall be paid the actual expenses incurred in attending its meetings. The period of service of the members of the committee shall be so arranged that one member shall retire each year, and the appointments to be for a period of five years. Appointments made to fill vacancies occurring other than in the regular manner are to be made for the remainder of the period in which the vacancy exists. (Mar. 3, 1901, ch. 872, § 10, 31 Stat. 1450; Feb. 14, 1903, ch. 552, § 10, 32 Stat. 829; Mar. 4, 1913, ch. 141, § 1, 37 Stat. 736.)

§ 278a. Repealed. Pub. L. 88-611, § 4 (a)(1), Oct. 2, 1964, 78 Stat. 991.

§ 278b. Working Capital Fund.

(a) Utilization; appropriations.

The National Bureau of Standards is authorized to utilize in the performance of its functions the Working Capital Fund established by the Act of June 29, 1950 (64 Stat. 275), and additional amounts as from time to time may be required for the purposes of said fund are authorized to be appropriated.

(b) Availability of Fund.

The working capital of the fund shall be available for obligation and payment for any activities authorized by sections 271-278e of this title, and for any activities for which provision is made in the appropriations which reimburse the fund.

(c) Reimbursements.

In the performance of authorized activities, the Working Capital Fund shall be available and may be reimbursed for expenses of hire of automobile, hire of consultants, and travel to meetings, to the extent that such expenses are authorized for the appropriations of the Department of Commerce.

(d) Credits.

The fund may be credited with advances and reimbursement, including receipts from non-Federal sources, for services performed under the authority of section 273 of this title.

(e) Cost defined.

As used in sections 271-278e of this title, the term "cost" shall be construed to include directly related expenses and appropriate charges for indirect and administrative expenses.

(f) Distribution of earnings; restoration of prior impairment.

The amount of any earned net income resulting from the operation of the fund at the close of each fiscal year shall be paid into the general fund of the Treasury: *Provided*, That such earned net income may be applied first to restore any prior impairment of the fund. (Mar. 3, 1901, ch. 872, § 12, as added July 22, 1950, ch. 486, § 2, 64 Stat. 371, and amended Aug. 3, 1956, ch. 906, § 2, 70 Stat. 959.)

§ 278c. Acquisition of land for field sites.

To the extent that funds are specifically appropriated therefor, the Secretary of Commerce is authorized to acquire land for such field sites as are necessary for the proper and efficient conduct of the activities authorized herein. (Mar. 3, 1901, ch. 872, § 13, as added Sept. 2, 1958, Pub. L. 85-890, § 1, 72 Stat. 1711.)

§ 278d. Construction and improvement of buildings and facilities.

Within the limits of funds which are appropriated for the National Bureau of Standards, the Secretary of Commerce is authorized to undertake such construction of buildings and other facilities and to make such improvements to existing buildings, grounds, and other facilities occupied or used by the National Bureau of Standards as are necessary for the proper and efficient conduct of the activities authorized herein: *Provided*, That no improvement shall be made nor shall any building be constructed under this authority at a cost in excess of \$40,000 unless specific provision is made therefor in the appropriation concerned. (Mar. 3, 1901, ch. 872, § 14, as added Sept. 2, 1958, Pub. L. 85-890, § 1, 72 Stat. 1711.)

§ 278e. Functions and activities.

In the performance of the functions of the National Bureau of Standards and the Secretary of Commerce is authorized to undertake the following activities: (a) The purchase, repair, and cleaning of uniforms for guards; (b) the repair and alteration of buildings and other plant facilities; (c) the rental of field sites and laboratory, office, and warehouse space; (d) the purchase of reprints from technical journals or other periodicals and the payment of page charges for the publication of research papers and reports in such journals; (e) the furnishing of food and shelter without repayment therefor to employees of the Government at Arctic and Antarctic stations; (f) for the conduct of observations on radio propagation phenomena in the Arctic or Antarctic regions, the appointment of employees at base rates established by the Secretary of Commerce which shall not exceed such maximum rates as may be specified from time to time in the appropriation concerned, and without regard to the civil service and classification laws and sections 911-913, 921, and 922 of Title 5; and (g) the erection on leased property of specialized facilities and working and living quarters when the Secretary of Commerce determines that this will best serve the interests of the Government. (Mar. 3, 1901, ch. 872, § 15, as added Sept. 2, 1958, Pub. L. 85-890, § 1, 72 Stat. 1711.)

§ 278f. Fire research and safety program; functions of Secretary of Commerce.

The Secretary of Commerce (hereinafter referred to as the "Secretary") is authorized to—

- (a) Investigations for determination of pertinent factors; prevention, control, and reduction of effects, methods and techniques; educational programs; fire information reference services; demonstration projects.

Conduct directly or through contracts or grants—

(1) investigations of fires to determine their causes, frequency of occurrence, severity, and other pertinent factors;

(2) research into the causes and nature of fires, and the development of improved methods and techniques for fire prevention, fire control, and reduction of death, personal injury, and property damage;

(3) educational programs to—

(A) inform the public of fire hazards and fire safety techniques, and

(B) encourage avoidance of such hazards and use of such techniques;

(4) fire information reference services, including the collection, analysis, and dissemination of data, research results, and other information, derived from this program or from other sources and related to fire protection, fire control, and reduction of death, personal injury, and property damage;

(5) educational and training programs to improve, among other things—

(A) The efficiency, operation, and organization of fire services, and

(B) The capability of controlling unusual fire-related hazards and fire disasters; and

(6) projects demonstrating—

(A) improved or experimental programs of fire prevention, fire control, and reduction of death, personal injury, and property damage,

(B) application of fire safety principles in construction, or

(C) improvement of the efficiency, operation, or organization of the fire services.

- (b) Engineering or science curriculums; instructional materials and aids.

Support by contracts or grants the development, for use by educational and other nonprofit institutions, of—

(1) fire safety and fire protection engineering or science curriculums; and

(2) fire safety courses, seminars, or other instructional materials and aids for the above curriculums or other appropriate curriculums or courses of instruction.

(Mar. 3, 1901, ch. 872, § 16, as added Mar. 1, 1968, Pub. L. 90-259, title I, § 102, 83 Stat. 35.)

§ 278g. Same; general provisions.

With respect to the functions authorized by section 278 of this title—

(a) Eligibility for grants; amount; conditions; definitions.

Grants may be made only to States and local governments, other non-Federal public agencies, and nonprofit institutions. Such a grant may be up to 100 per centum of the total cost of the project for which such grant is made. The Secretary shall require, whenever feasible, as a condition of approval of a grant, that the recipient contribute money, facilities, or services to carry out the purpose for which the grant is sought. For the purposes of this section, "State" means any State of the United States, the District of Columbia, the Commonwealth of Puerto Rico, the Virgin Islands, Guam, the Canal Zone, American Samoa, and the Trust Territory of the Pacific Islands; and "public agencies" includes combinations or groups of States or local governments.

(b) Reimbursement of Federal agencies; delegation of powers.

The Secretary may arrange with and reimburse the heads of other Federal departments and agencies for the performance of any such functions, and, as necessary or appropriate, delegate any of his powers under this section or section 278f of this title with respect to any part thereof, and authorize the redelegation of such powers.

(c) Advances of public moneys.

The Secretary may perform such functions without regard to section 529 of Title 31.

(d) Cooperation of Federal agencies.

The Secretary is authorized to request any Federal department or agency to supply such statistics, data, program reports, and other materials as he deems necessary to carry out such functions. Each such department or agency is authorized to cooperate with the Secretary and, to the extent permitted by law, to furnish such materials to the Secretary. The Secretary and the heads of other departments and agencies engaged in administering programs related to fire safety shall, to the maximum extent practicable, cooperate and consult in order to insure fully coordinated efforts.

(e) Administration of functions; rules and regulations.

The Secretary is authorized to establish such policies, standards, criteria, and procedures and to prescribe such rules and regulations as he may deem necessary or appropriate to the administration of such functions or this section, including rules and regulations which—

(1) provide that a grantee will from time to time, but not less often than annually, submit a report evaluating accomplishments of activities funded under section 278f of this title, and

(2) provide for fiscal control, sound accounting procedures, and periodic reports to the Secretary regarding the application of funds paid under section 278f of this title.

(Mar. 3, 1901, ch. 872, § 17, as added Mar. 1, 1968, Pub. L. 90-259, title I, § 102, 82 Stat. 35.)

§ 279. Absence of Director.

In the case of the absence of the Director of the Bureau of Standards the Secretary of Commerce may designate some officer of said bureau to perform the duties of the director during his absence. (Mar. 4, 1911, ch. 237, § 1, 36 Stat. 1231; Mar. 4, 1913, ch. 141, § 1, 37 Stat. 736.)

§ 280. Apprentices; promotion.

Apprentices in the Bureau of Standards may be promoted after satisfactory apprenticeship, with the approval of the Civil Service Commission, to positions corresponding to the journeyman grades for which their duties logically prepare them, without regard to apportionment: *Provided*, That they thus acquire no rights to transfer to other lines of work. (July 16, 1914, ch. 141, § 1, 38 Stat. 502.)

§ 281. Testing materials for District of Columbia.

Materials for fireproof buildings, other structural materials, and all materials, other than materials for paving and for fuel, purchased for and to be used by the government of the District of Columbia, when necessary in the judgment of the commissioners to be tested, shall be tested by the Bureau of Standards under the same conditions as similar testing is required to be done for the United States Government. (Mar. 4, 1913, ch. 150, 37 Stat. 945.) ?

§ 282. National hydraulic laboratory; establishment; purpose; study of Federal and State projects.

There is authorized to be established in the Bureau of Standards of the Department of Commerce a national hydraulic laboratory for the determination of fundamental data useful in hydraulic research and engineering, including laboratory research relating to the behavior and control of river and harbor waters, the study of hydraulic structures and water flow, and the development and testing of hydraulic instruments and accessories; *Provided*, That no test, study, or other work on a problem or problems connected with a project the prosecution of which is under the jurisdiction of any department or independent agency of the Government shall be undertaken in the laboratory herein authorized until a written request to do such work is submitted to the Director of the Bureau of Standards by the head of the department or independent agency charged with the execution of such project: *And provided further*, That any State or political subdivision thereof may obtain a test, study, or other work on a problem connected with a project the prosecution of which is under the jurisdiction of such State or political subdivision thereof. (May 14, 1930, ch. 275, § 1, 46 Stat. 327.)

§ 283. Repealed. Pub. L. 89-554, § 8(a), Sept. 6, 1966, 80 Stat. 655, 656.

§ 284. Transfer of materials, supplies, and equipment to Bureau for Arctic ionosphere observation by Departments of Army, Navy, and Air Force.

§ 285, 286. Repealed. Pub. L. 85-890, § 3, Sept. 2, 1958, 72 Stat. 1712.

#### Chapter 7A.—STANDARD REFERENCE DATA PROGRAM

Sec.

290. Congressional declaration of policy.

290a. Definitions.

290b. Collection, compilation, critical evaluation, publication and dissemination of standard reference data.

290c. Standards, criteria, and procedures for preparation and publication of standard reference data; publication in Federal Register.

290d. Sale of standard reference data; cost recovery; proceeds subject to Bureau of Standards.

290e. United States copyright and renewal rights.

290f. Authorization of appropriations.

§ 290. Congressional declaration of policy.

The Congress hereby finds and declares that reliable standardized scientific and technical reference data are of vital importance to the progress of the Nation's science and technology. It is therefore the policy of the Congress to make critically evaluated reference data readily available to scientists, engineers, and the general public. It is the purpose of this chapter to strengthen and enhance this policy. (Pub. L. 90-396, § 1, July 11, 1968, 82 Stat. 339.)

§ 290a. Definitions.

For the purposes of this chapter—

(a) The term "standard reference data" means quantitative information, related to a measurable physical or chemical property of a substance or system of substances of known composition and structure, which is critically evaluated as to its reliability under section 290b of this title.

(b) The term "Secretary" means the Secretary of Commerce. (Pub. L. 90-396, § 2, July 11, 1968, 82 Stat. 340.)

§ 290b. Collection, compilation, critical evaluation, publication and dissemination of standard reference data.

The Secretary is authorized and directed to provide or arrange for the collection, compilation, critical evaluation, publication, and dissemination of standard reference data. In carrying out this program, the Secretary shall, to the maximum extent practicable, utilize the reference data services and facilities of other agencies and instrumentalities of the Federal Government and of State and local governments, persons, firms, institutions, and associations, with their consent and in such a manner as to avoid duplication of those services and facilities. All agencies and instrumentalities of the Federal Government are encouraged to exercise their duties and functions in such manner as will assist in carrying out the purpose of this chapter. This section shall be deemed complementary to existing authority, and nothing herein is intended to repeal, supersede, or diminish existing authority or responsibility of an agency or instrumentality of the Federal government. (Pub. L. 90-396, § 3, July 11, 1968, 82 Stat. 340.)

§ 290c. Standards, criteria, and procedures for preparation and publication of standard reference data; publication in Federal Register.

To provide for more effective integration and coordination of standard reference data activities, the Secretary, in consultation with other interested Federal agencies, shall prescribe and publish in the Federal Register such standards, criteria, and procedures for the preparation and publication of standard reference data as may be necessary to carry out the provisions of this chapter. (Pub. L. 90-396, § 4, July 11, 1968, 82 Stat. 340.)

§ 290d. Sale of standard reference data; cost recovery; proceeds subject to Bureau of Standards.

Standard reference data conforming to standards established by the Secretary may be made available and sold by the Secretary or by a person or agency designated by him. To the extent practicable and appropriate, the prices established for such data may reflect the cost of collection, compilation, evaluation, publication, and dissemination of the data, including administrative expenses; and the amounts received shall be subject to the Act of March 3, 1901, as amended. (Pub. L. 90-396, § 5, July 11, 1968, 82 Stat. 340.)

§ 290e. United States copyright and renewal rights.

(a) Notwithstanding the limitations contained in section 8 of Title 17, the Secretary may secure copyright and renewal thereof on behalf of the United States as author or proprietor in all or any part of any standard reference data which he prepares or makes available under this chapter, and may authorize the reproduction and publication thereof by others.

(b) The publication or republication by the Government under this chapter, either separately or in a public document, or any material in which copyright is subsisting shall not be taken to cause any abridgment or annulment of the copyright or to authorize any use or appropriation of such material without the consent of the copyright proprietor. (Pub. L. 90-396, § 6, July 11, 1968, 82 Stat. 340.)

§ 290f. Authorization of appropriations.

There are authorized to be appropriated to carry out this chapter, \$1.86 million for the fiscal year ending June 30, 1969. Notwithstanding the provisions of any other law, no appropriations for any fiscal year may be made for the purpose of this chapter after fiscal year 1969 unless previously authorized by legislation hereafter enacted by the Congress. (Pub. L. 90-396, 7, July 11, 1968, 82 Stat. 340.)



This page intentionally left blank

## APPENDIX D

### THE NATIONAL BUREAU OF STANDARDS IN THE FEDERAL ADMINISTRATION

#### UNITED STATES PRESIDENTS

William McKinley  
1897-1901

Theodore Roosevelt  
1901-9

William Howard Taft  
1909-13

Woodrow Wilson  
1913-21

Warren G. Harding  
1921-23

Calvin Coolidge  
1923-29

Herbert C. Hoover  
1929-33

Franklin D. Roosevelt  
1933-45

Harry S. Truman  
1945-53

Dwight D. Eisenhower  
1953-61

John F. Kennedy  
1961-63

Lyndon B. Johnson  
1963-69

Richard M. Nixon  
1969-74

#### DEPARTMENT SECRETARIES

Lyman J. Gage  
Secretary of Treasury  
1897-1901

Leslie M. Shaw  
1901

George B. Cortelyou  
Secretary of Commerce  
and Labor, 1903-4

Victor H. Metcalf  
1904-6

Oscar S. Straus  
1906-9

Charles Nagel  
1909-13

William C. Redfield  
Secretary of Commerce  
1913-19

Joshua W. Alexander  
1919-21

Herbert C. Hoover  
1921-28

William F. Whiting  
1928-29

Robert P. Lamont  
1929-32

Roy D. Chapin  
1932-33

Daniel C. Roper  
1933-39

Harry L. Hopkins  
1939-40

Jesse Jones  
1940-45

Henry A. Wallace  
1945-46

W. Averell Harriman  
1947-48

Charles W. Sawyer  
1948-52

Sinclair Weeks  
1952-58

Lewis L. Strauss  
1958-59

Frederick H. Mueller  
1959-61

Luther H. Hodges  
1961-65

John T. Conner  
1965-67

Alex B. Trowbridge  
1967-68

Cyrus R. Smith  
1968-69

Maurice H. Stans  
1969-1972

#### NBS DIRECTORS

Samuel W. Stratton  
1901-22

George K. Burgess  
1922-32

Lyman J. Briggs  
1932-46  
Edward U. Condon  
1946-51

Allen V. Astin  
1951-68

Lewis M. Branscomb  
1969-71

This page intentionally left blank

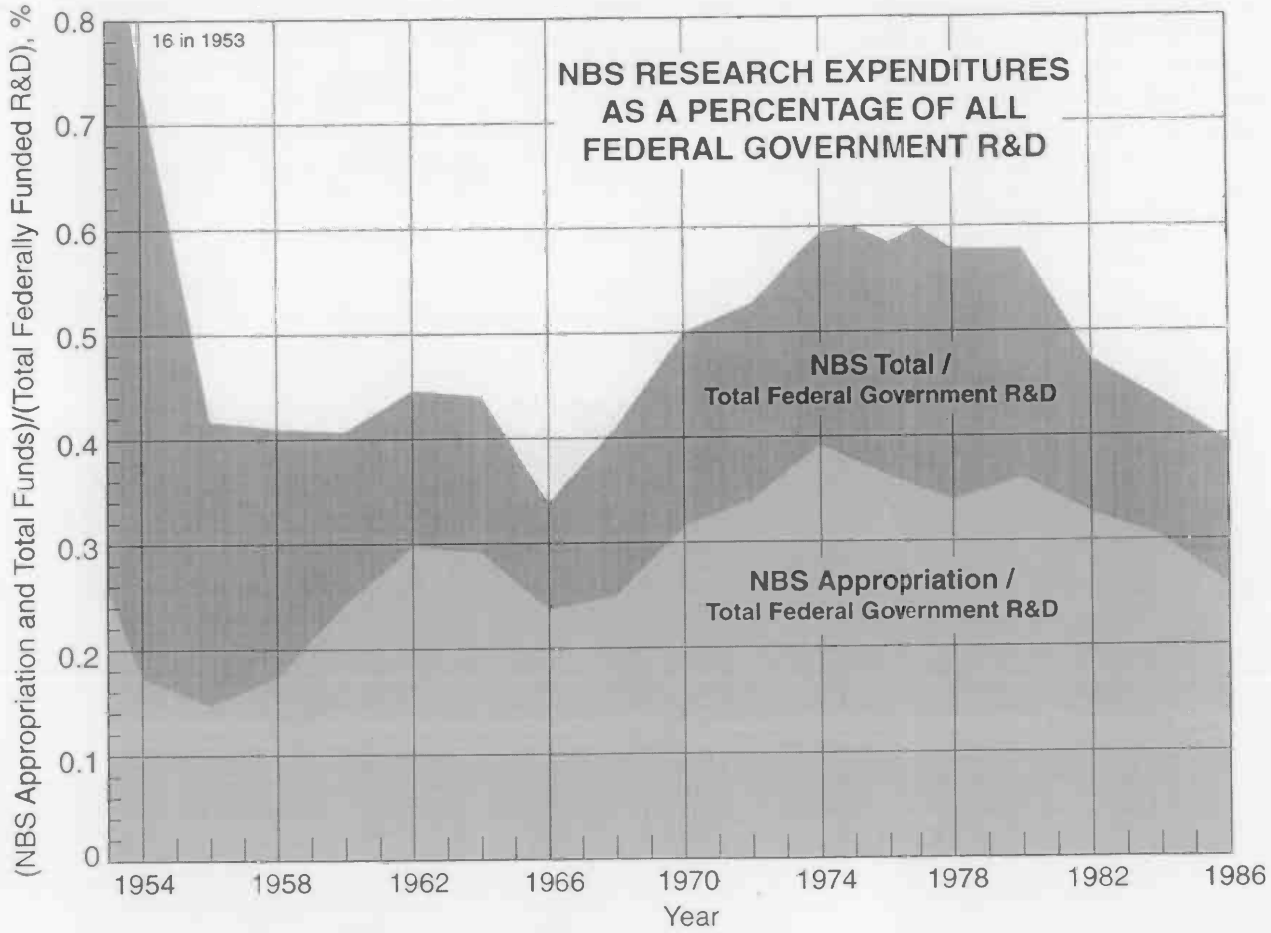

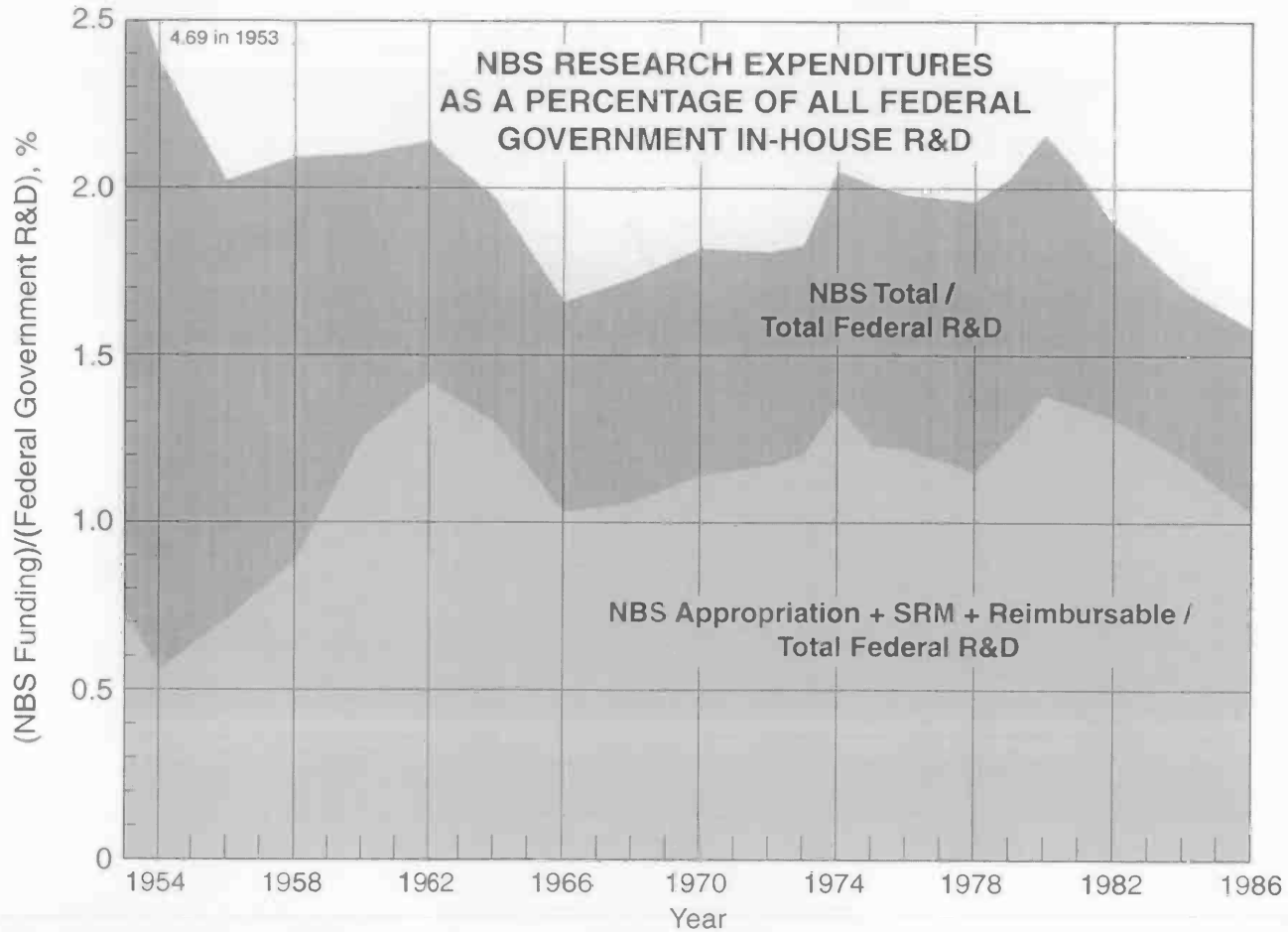

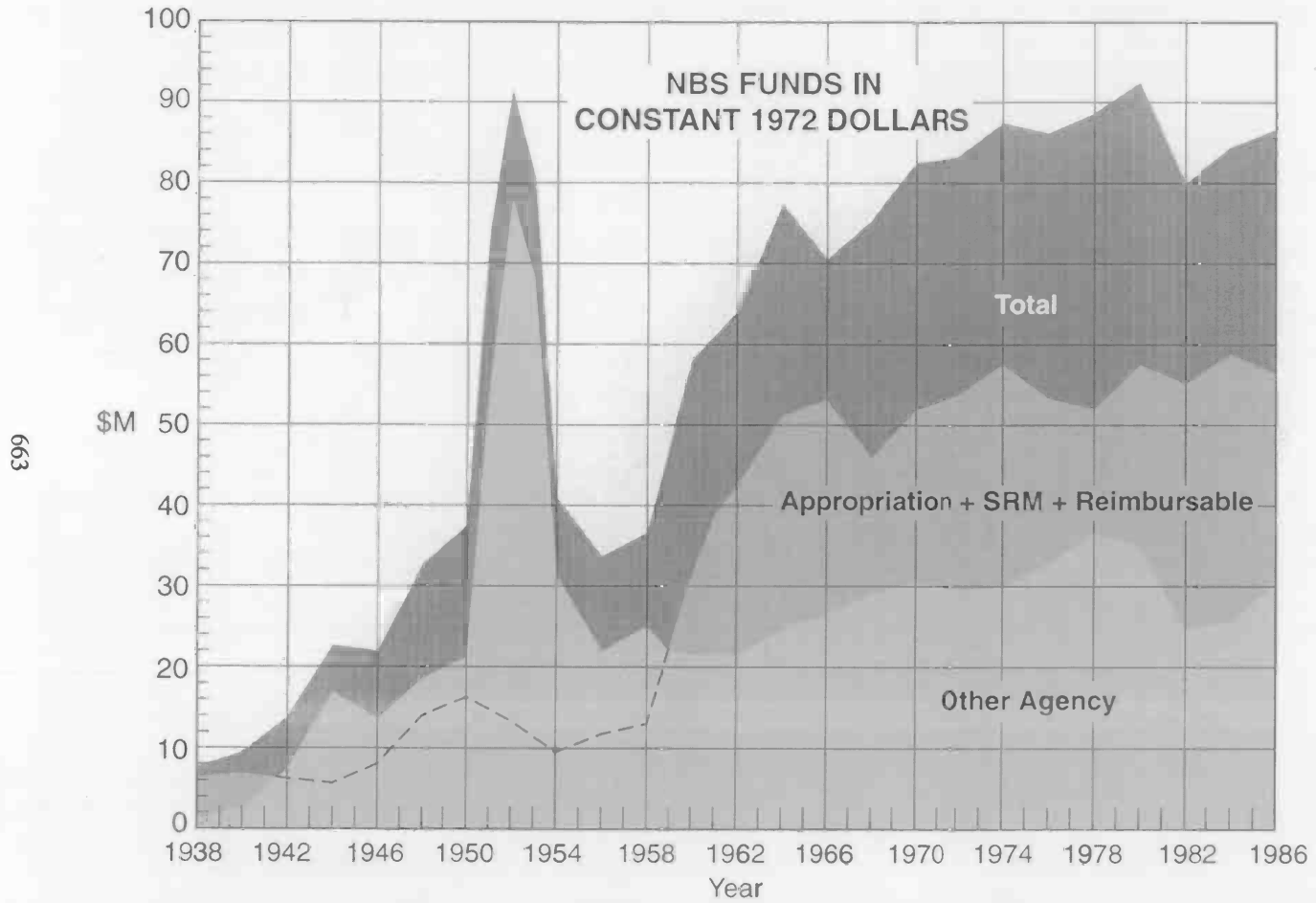

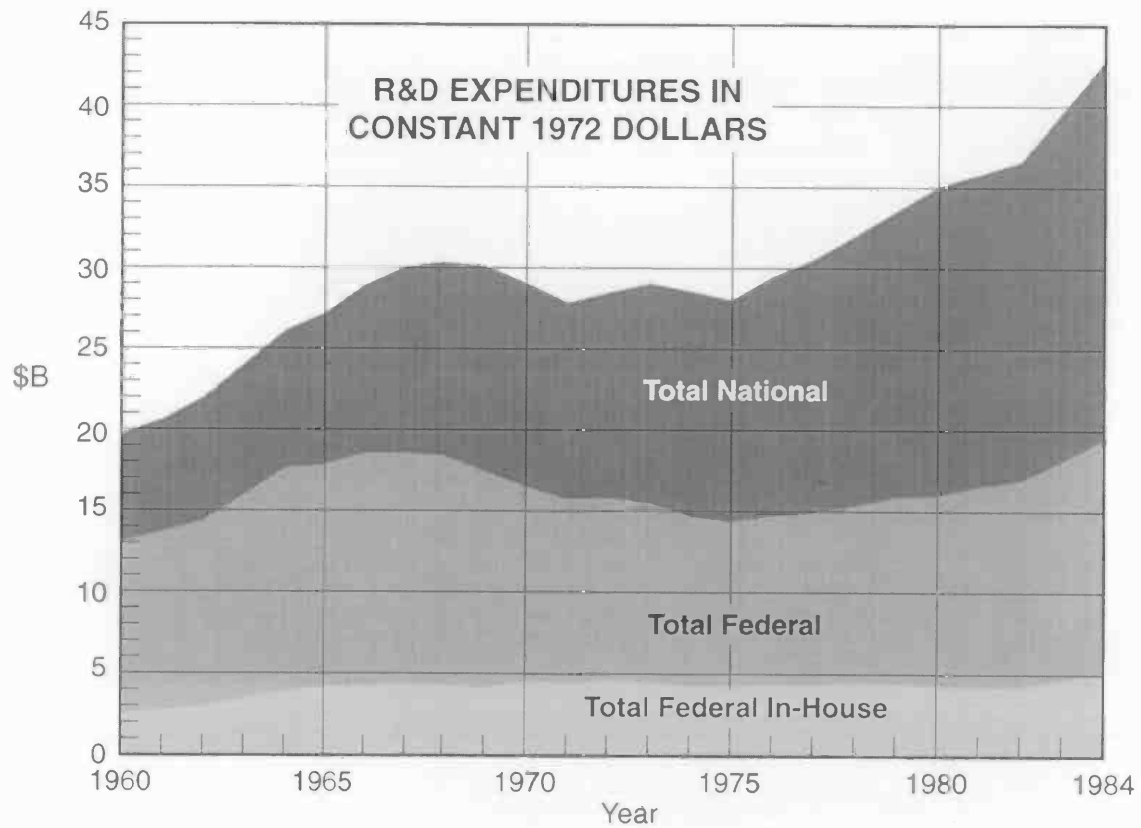

---

## APPENDIX F

---

### MEMBERS OF THE VISITING COMMITTEE OF THE SECRETARY OF COMMERCE TO NBS AND NIST<sup>1</sup>

	<i>Term</i>
ALBERT LADD COLBY . . . . .	1901-07
Consulting engineer in metallurgy, South Bethlehem, Pa., and secretary, Association of American Steel Manufacturers.	
DR. ELIHU THOMSON . . . . .	1901-18
Electrical engineer, General Electric Co., Lynn, Mass.	
DR. IRA REMSEN . . . . .	1901-09
Director of Chemical Laboratory and president, Johns Hopkins University.	
DR. HENRY S. PRITCHETT . . . . .	1901-10
President, Massachusetts Institute of Technology; later president, Carnegie Foundation for the Advancement of Teaching.	
PROF. EDWARD L. NICHOLS . . . . .	1901-11
Professor of physics, Cornell University.	
DR. ROBERT S. WOODWARD . . . . .	1908-12
President, Carnegie Institution of Washington.	
PROF. HENRY M. HOWE . . . . .	1909-14
Professor of metallurgy, Columbia University.	
PROF. ARTHUR G. WEBSTER . . . . .	1910-15
Director, Physics Laboratory, Clark University.	
PROF. JOHN F. HAYFORD . . . . .	1912-21
Director, College of Engineering, Northwestern University.	
PROF. ARTHUR E. KENNELLY . . . . .	1912-17
Professor of electrical engineering, Harvard University.	
JOHN R. FREEMAN . . . . .	1915-24, 1926-31
Consulting engineer, Providence, R.I.	
PROF. WILLIAM A. NOYES . . . . .	1915-20
Director, Chemical Laboratory, University of Illinois.	
PROF. JOSEPH S. AMES . . . . .	1917-22
Director, Physical Laboratory, Johns Hopkins University.	
PROF. FRED W. McNAIR . . . . .	1921-23
President, Michigan College of Mines, Houghton, Mich.	
PROF. WILDER D. BANCROFT . . . . .	1920-25
Professor of physical chemistry, Cornell University.	
DR. AMBROSE SWASEY . . . . .	1921-26
Chairman of the Board, Warner & Swasey Co., Cleveland, Ohio.	
DR. SAMUEL W. STRATTON . . . . .	1923-31
President, Massachusetts Institute of Technology.	

---

<sup>1</sup> Sources: NARG 167, NBS Box 296; NARG 40, files of Secretary of Commerce, 67009/5; current files, Office of the Director, NBS.



	<i>Term</i>
GANO DUNN . . . . .	1923-48
President, J. G. White Engineering Corp., New York.	
PROF. WILLIAM F. DURAND . . . . .	1924-29
Professor of mechanical engineering, Leland Stanford University.	
DR. WILLIS R. WHITNEY . . . . .	1925-30
Director, General Electric Research Laboratory, Schenectady, N.Y.	
DR. CHARLES F. KETTERING . . . . .	1929-34, 1947-52
Director of research and vice president, General Motors Corp.	
DR. CHARLES L. REESE . . . . .	1930-35
Consulting chemist to E. I. du Pont de Nemours & Co.	
MORRIS E. LEEDS . . . . .	1931-41
President, Leeds & Northrup Co., Philadelphia, Pa.	
DR. KARL T. COMPTON . . . . .	1931-47
President, Massachusetts Institute of Technology.	
DR. WILLIAM D. COOLIDGE . . . . .	1935-49
Vice president and director of research, General Electric Co.	
DR. FRANK B. JEWETT . . . . .	1935-45
Vice president in charge of research and development, American Telephone & Telegraph Co.; president, National Academy of Sciences.	
DR. VANNEVAR BUSH . . . . .	1942-46
President, Carnegie Institution of Washington; director, Office of Scientific Research and Development.	
DR. HAROLD C. UREY . . . . .	1945-50
Research professor of chemistry, University of Chicago.	
DR. EUGENE P. WIGNER . . . . .	1946-51
Metallurgical Laboratory, University of Chicago; director of research, Clinton Laboratories, Oak Ridge, Tenn.	
DR. ROBERT F. MEHL . . . . .	1948-53
Director, Metals Research Laboratory, Carnegie Institute of Technology.	
DR. DONALD H. MENZEL . . . . .	1949-54
Chairman, Department of Astronomy, Harvard University; associate director, Harvard Observatory.	
DR. DETLEV W. BRONK . . . . .	1950-60
President, Johns Hopkins University.	
PROF. JOHN H. VAN VLECK . . . . .	1951-56
Dean, Division of Applied Science, Harvard University.	
DR. MERVIN J. KELLY . . . . .	1952-62
President, Bell Telephone Laboratories.	
DR. CLYDE E. WILLIAMS . . . . .	1953-58
Director, Battelle Memorial Institute, Columbus, Ohio.	
DR. CRAWFORD H. GREENEWALT . . . . .	1954-64
President, E. I. du Pont de Nemours & Co.	
PROF. FREDERICK SEITZ . . . . .	1956-61
Chairman, Department of Physics, University of Illinois.	
DR. LLOYD V. BERKNER . . . . .	1957-62
Scientific research administrator; chairman, Space Science Board, National Academy of Sciences.	

	<i>Term</i>
PROF. CHARLES H. TOWNES..... Department of Physics, Columbia University, consultant, Brookhaven National Laboratories.	1960-65
EMANUEL R. PRYORE..... Vice president and chief scientist, International Business Machines, Incorporated.	1962-72
ELMER W. ENGSTROM..... President, Radio Corporation of America.	1963-71
PAUL C. CROSS..... President, Mellon Institute.	1964-69
NORMAN F. RAMSEY..... Department of Physics, Harvard University.	1965-70, 1982-87
ROBERT L. SPROULL..... Vice president, University of Rochester.	1966-71
JACK E. GOLDMAN..... Senior vice president, Research and Development, Xerox Corp.	1969-74
JAMES C. FLETCHER..... President, University of Utah.	1970-71

This page intentionally left blank

# APPENDIX G

## NBS AUTHORIZED PERSONNEL CHART

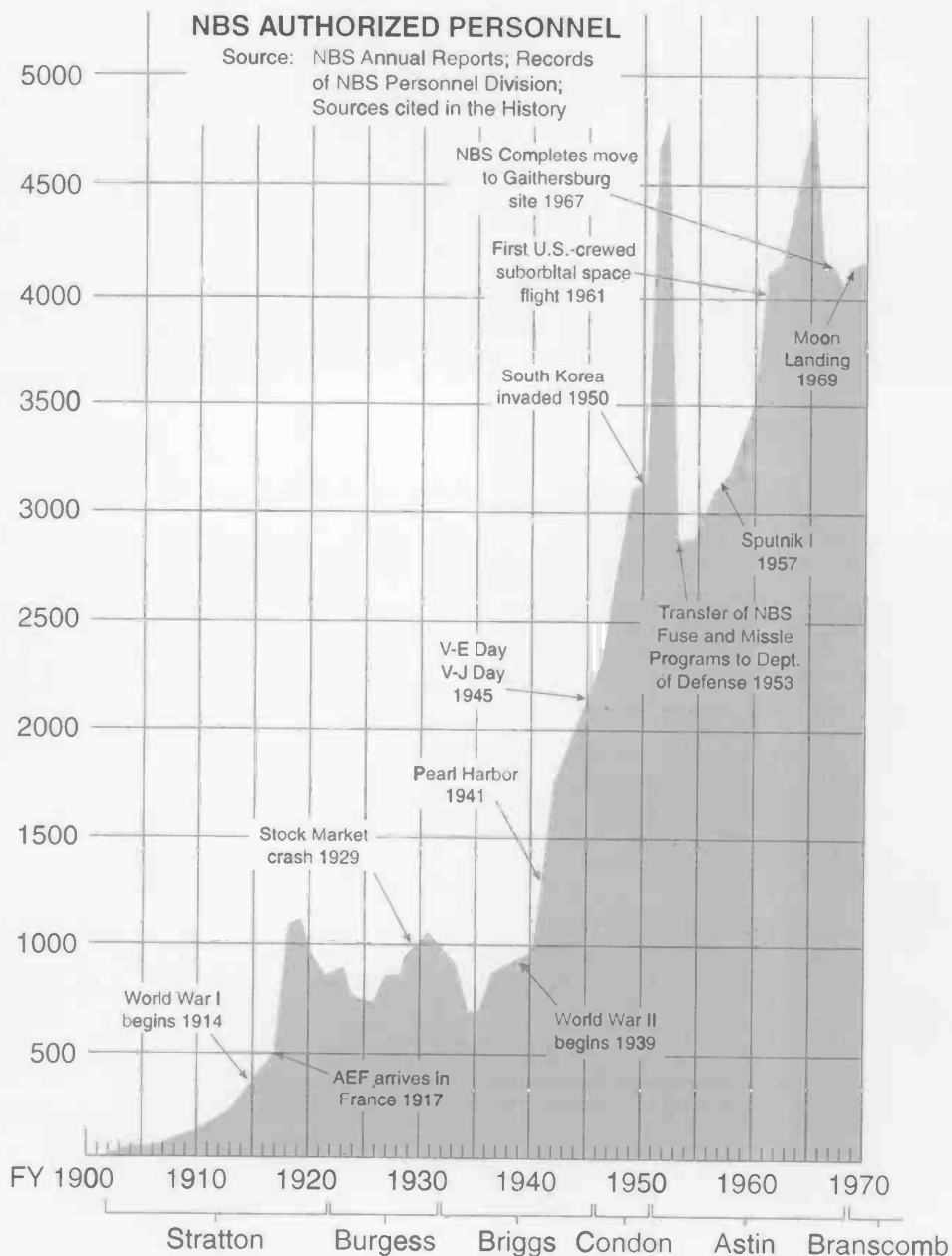

This page intentionally left blank

---

## APPENDIX H

---

### NBS/NIST PUBLICATIONS

#### Aeronautic Instruments Circulars

TL589.U47  
No. 1-51 (1918-1921)

These technical circulars discussed the principles involved in the various aeronautic instruments and the methods of testing employed by the Aeronautic Instruments Section. The confidential reports were duplicated for temporary use and served to make the results immediately available for the instruction of the experts engaged in aviation work in the technical divisions of the Army and Navy. They were not for publication.

#### Aeronautic Power Plants Reports

TL521.A33  
No. 3-53 (1918-1919)

These technical reports were results of investigations by the NBS Airplane Power Plant Section for the National Advisory Committee for Aeronautics. The reports were confidential for use by the Army, Navy, and authorized civilians.

#### Annual Reports

QC100.U55  
Fiscal Year 1902–Fiscal Year 1985

The title varies and includes:

*Annual Report of the Director of the National Bureau of Standards for the Fiscal Year Ended . . .*

(June 30, 1902–June 30, 1903)

*Annual Report of the Director of the Bureau of Standards to the Secretary of Commerce and Labor for the Fiscal Year Ended . . .* (June 30, 1904–June 30, 1912)

*Annual Report of the Director, Bureau of Standards to the Secretary of Commerce for the Fiscal Year Ended . . .* (June 30, 1913–June 30, 1921)

*Annual Report of the Director of the Bureau of Standards to the Secretary of Commerce for the Fiscal Year Ended . . .* (June 30, 1922–June 30, 1932)

*Reprinted from the Annual Report of the Secretary of Commerce. Bureau of Standards.* (1933)

*Reprinted from the Annual Report of the Secretary of Commerce. National Bureau of Standards.* (1934-1942)

The *Annual Reports of the National Bureau of Standards* for the fiscal years 1943, 1944, and 1945 were not published because of economy measures taken during World War II. The manuscripts for these annual reports were submitted to the secretary of commerce in typewritten form.

*Annual Report of the National Bureau of Standards. Reprinted from the Annual Report of the Secretary of Commerce.* (1946-1948)

*Annual Report . . . National Bureau of Standards.* (1949-1952)

*Biennial Report 1953 and 1954, National Bureau of Standards.* From the Preface: At the scheduled time for the preparation and release of the 1953 report the Bureau was undergoing comprehensive survey by an Ad Hoc Committee [Kelly Committee] appointed by the secretary of commerce to "evaluate the present functions and operation of the NBS in relation to present national needs." A number of important changes affecting the over-all Bureau program were made as a result of this survey. It was considered more appropriate to delay the report for a year in order to include the complete recommendations of the Ad Hoc Committee rather than to report on them partially.

*Annual Report . . . National Bureau of Standards.* (1955-1957)  
*Research Highlights of the National Bureau of Standards. Annual Report, Fiscal Year . . .* (1958-1963)  
*Technical Highlights of the National Bureau of Standards. Annual Report, Fiscal Year . . .* (1964-1970)  
*NBS 1971 Annual Report.* SP-397 June 1972  
*National Bureau of Standards, NBS.* (1972) SP-367 Oct 1972  
*National Bureau of Standards, NBS.* [1973] SP-397 June 1974  
*NBS Annual Report Fiscal Year 1974.* SP-418 March 1975  
*National Bureau of Standards Annual Report FY 1975.* SP-437 Dec 1975  
*National Bureau of Standards, Perspectives on Standards.* (1976) SP-467 March 1977  
*Science on it's Way to Work, Activities of the National Bureau of Standards.*  
 [1977] SP-498 April 1978  
*National Bureau of Standards, A National Resource for Science and Technology, Fiscal Year 1978.*  
 SP-538 July 1979  
 1979 was not published.  
*National Bureau of Standards 1980.* SP-600 Jan 1981  
*National Bureau of Standards 1982.* [covered fiscal years 1981 and 1982] SP-643 Feb 1983  
*National Bureau of Standards.* [1983] SP-679 July 1984  
*National Bureau of Standards.* [1985] SP-679 July 1984, revised April 1986.  
 The last annual report in this series was published in 1986 as a revision of the previous report. The two publications differ in all but a few minor areas.

#### **Applied Mathematics Series**

QA3.U5

No. 1-63 (1948-1973)

This series contains mathematical tables, manuals and studies of special interest to physicists, engineers, chemists, biologists, mathematicians and others engaged in scientific and technical work. Some of the publications are reissues of the Mathematical Tables prepared by members of the Project for the Computation of Mathematical Tables. This series is inactive as none have been published since 1973.

#### **BASIC RADIO PROPAGATION PREDICTIONS SERIES**

This monthly series was prepared by the Interservice Radio Propagation Laboratory (IRPL) which was set up during WWII by the United States Joint Communications Board at NBS. The series succeeded "Radio Propagation Conditions," also prepared by the IRPL. The predictions series was initially restricted and available only to the military as a basic supplement to the IRPL's "Radio Propagation Handbook" issued by the military. Predictions were made three months in advance. May 1, 1946, the wartime IRPL ceased to exist and its duties and functions were assumed by the Central Radio Propagation Laboratory (CRPL) of the National Bureau of Standards. In July 1946 the series was made available by annual subscription to those concerned with radio communication in determining the best sky-wave frequencies over any path at any time of day for average conditions. In September 1947, various maps, charts, diagrams, and nomograms needed to make practical application of the world-contour charts were added with examples of their use.

##### **Basic Radio Propagation Predictions, IRPL Series D**

TK6570.B7U47

No. 1-22 (1944-June 1946)

Continued by: Basic Radio Propagation Predictions, CRPL Series D

##### **Basic Radio Propagation Predictions, CRPL Series D**

TK6570.B7U47

No. 23-220 (July 1946-1962)

Continues: Basic Radio Propagation Predictions, IRPL Series D

Superseded by: Ionospheric Predictions

### **Building and Housing**

TH1.U4

No. 1-18 (1923-1932)

This series contained reports of the work of the Building and Housing Division that included gathering and distributing scientific, practical, statistical, and other information tending to reduce costs, and encourage and improve construction and housing. It covered investigations for use in framing local building and plumbing codes, and a study of problems connected with city zoning. Information on the prices, production, consumption, and stocks of building materials, and on building activity was collected, analyzed, and distributed. Special attention was paid to factors bearing on the housing problem. The work included studies of building practices, and cooperative efforts to reduce seasonal operations and otherwise eliminate waste in the construction industries.

### **Building Materials and Structures Reports**

TA410.U48

No. 1-152 (1938-1959)

This series reported the results of Bureau investigations on the properties and suitability of new materials and new methods of construction. The program was carried out with the cooperation and advice of the housing agencies of the Government. The objective was to furnish the Government, the building industry, and the public with technical information that would be useful with particular reference to low-cost housing. This series was discontinued in July 1959 and papers on building technology were then published in the *Journal of Research*—usually *Section C. Engineering and Instrumentation*—or the Monograph series.

Building Science Series *see* NIST Building Science Series

Bulletin of the Bureau of Standards *see* Journal of Research

Circulars *see* National Bureau of Standards Circular

### **Commercial Standards**

QC100.U5553

Nos. 0-274 (1928-1966)

Commercial standards were voluntary, recorded standards agreed upon by producers, distributors, and consumers, covering terminology, types, classifications, grades, sizes, and use characteristics of manufactured products as a basis for better understanding between buyers and sellers. They generally included standard methods of test, rating, certification, and labeling, and provided a uniform basis for fair competition. Each standard included a list of members of the standing committee, a history of the project, and list of acceptors. After 1966 as *Commercial Standards* were revised, they became *Product Standards* and in 1969, *Voluntary Product Standards*.

### **Commercial Standards Monthly**

HD62.U3

Vol. [1]-9 (1925-1933)

This periodical was a review of progress in commercial simplification and standardization. It covered the national movement initiated by President Hoover for the reduction of needless sizes and varieties of products and the promotion of voluntary commercial standardization by industry.

### **Consumer Information Series**

TX335.A1U6

No. 1-10 (1970-1978)

This series contained practical information, based on NBS research and experience, covering areas of interest to the consumer. Easily understandable language and illustrations provide useful background knowledge for shopping in today's technological marketplace. This series is inactive as none have been published since 1978.



**CRPL Report**

QC503.U5

No. 1-1 - 9-10 (July 1946-1950)

Supersedes: IRPL Report

Reports prepared by the Central Radio Propagation Laboratory at NBS.

**CRPL-F, PART A: IONOSPHERIC DATA**

These bulletins represent a variety of data collected by IRPL, later CRPL, in the course of its research and service activities. The data were made available for use in research on radio propagation and the ionosphere, and in other geophysical applications.

**Ionospheric Data, IRPL-F**

QC503.U5

No. 1-22 (1944 - June 1946)

Continued by: Ionospheric Data, CRPL-F

**Ionospheric Data, CRPL-F**

QC503.U5

No. 23-134 (July 1946-1955)

Continues: Ionospheric Data, IRPL-F

Split into two parts: CRPL-F, Part A and CRPL-F, Part B

**CRPL-F, Part A: Ionospheric Data**

QC503.U5

No. 135-256 (1955-1965)

Continues in part: Ionospheric Data, CRPL-F

Continued as U.S. Environmental Science Services Administration. Institute for Telecommunication Sciences. CRPL-FA: Ionospheric Data

**CRPL-F, Part B: Solar-Geophysical Data**

QC503.U51

No. 135-256 (1955-1965)

Continues in part: Ionospheric Data, CRPL-F

Continued as U.S. Environmental Science Services Administration. Institute for Telecommunication Sciences. CRPL-FB: Solar-Geophysical Data

**DIMENSIONS**

During World War I the Bureau originally issued the *Confidential Bulletin* as an information bulletin for the military of ordnance work done by the Bureau. The name was changed to *Technical News Bulletin* (TNB) and the first issue, no. 26, June 20, 1919, was also issued as *Confidential Bulletin* no. 26, June 20, 1919. These two publications were the same except for information items concerning ordnance that were blanked out of the TNB.

The *Technical News Bulletin*, available by annual subscription, summarized the current research, development, and test activities of the Bureau. The articles were brief, with emphasis on the results of research and their significance, chosen for their importance to other scientists, engineers, and to industry. Resumes of longer research reports, important national and international conferences on fundamental science in which the Bureau represented the Nation, and a bibliography of all publications by members of the staff as published were included. The Bulletin was designed to give a succinct account of the current work of the Bureau.

*Dimensions* continued the TNB in a popular magazine format to inform scientists, engineers, businessmen, industry, teachers, students, and consumers of the latest advances in science and technology, with primary emphasis on the work at NBS. It highlighted and reviewed such issues as energy research, fire protection, building technology, metric conversion, pollution abatement, health and safety, and consumer product performance in addition to Bureau programs in measurement standards and techniques, properties of matter and materials, engineering standards and services, instrumentation, and automatic data processing.

**Confidential Bulletin**

T1.U45

No. 1-26 (Dec. 15, 1917–June 20, 1919)

Continued by: Technical News Bulletin of the Bureau of Standards

**Technical News Bulletin of the Bureau of Standards**

T1.U45

No. 26-204 (1919-1934)

Continued by: Technical News Bulletin of the National Bureau of Standards

**Technical News Bulletin of the National Bureau of Standards**

T1.U45

No. 205– Vol. 57 no. 7 (May 1934–July 1973)

(after no. 356, Dec. 1946, changed to volume numbering with Vol. 31 no. 1, Jan. 1947)

Continues: Technical News Bulletin of the Bureau of Standards

Continued by: *Dimensions: the Magazine of the National Bureau of Standards*

**Dimensions: the Magazine of the National Bureau of Standards**

T1.U45

Vol. 57 no. 8–Vol. 65 no. 8 (Aug. 1973–Oct. 1981)

Continues: Technical News Bulletin of the National Bureau of Standards

Additional title: *Dimensions/NBS*

**Federal Information Processing Standards Publications**

JK468.A8A3

No. 0 (1968)–present

This series is the official publication relating to standards and guidelines developed for Federal computer systems by the National Institute of Standards and Technology and promulgated under the Federal Property and Administrative Services Act of 1949, Section 111(d), as amended by the Computer Security Act of 1987, Public Law 100-235 (101 Stat. 1724) January 8, 1988.

**Federal Specifications**

The Bureau developed specifications for the purchase of supplies (other than foods and drugs) for the Federal Government. These specifications were generally recognized as dependable guides by many large organizations and purchasing agencies in achieving purchasing economy. The Bureau endorsed these specifications and published them for distribution. The first one published by the Bureau was Circular 13, *Standard Specifications for the Purchase of Carbon-Filament Incandescent Lamps*, in 1907. The first official U.S. Government specification, authorized by Presidential order, was published as Bureau Circular C33, *United States Government Specification for Portland Cement*, in 1912. Specifications were published in the Circular and Miscellaneous Publications series.

In 1921 The Federal Specifications Board was created by the Bureau of the Budget to unify specifications already available to government agencies. Bureau specifications accepted by the Board became official standards and were binding on all departments of the Federal Government.

### **Gage Section Communications**

TJ1166.U5  
1919-1920

The various communications of the Gage Section of the Weights and Measures Division contained information about the practical problems of gauges and gauging methods including work carried out with the National Screw Thread Commission.

Handbooks *see* NIST Handbooks

### **Hydraulic Laboratory. Bulletin. Series B: Hydraulic Laboratories in the United States**

TC1.U5  
(1933 and 1935, 1st rev.)

This series updated *Hydraulic Laboratories in the United States of America*, giving descriptions of 47 hydraulic laboratories in the United States.

### **HYDRAULIC RESEARCH IN THE UNITED STATES**

These reports represented a cooperative attempt on the part of the hydraulic laboratories in the United States to bring about the effective interchange of information relating to research projects being carried out in these laboratories. NBS served as a central agency to compile, publish and distribute information related to current hydraulic laboratory research.

### **Hydraulic Laboratory. Bulletin. Series A: Current Hydraulic Laboratory Research in the United States**

TC1.U51  
No. 1-10 (1933-1942)  
Continued by: *Hydraulic Research in the United States*

### **Hydraulic Research in the United States**

TC1.U51  
Vol. 11-14 (1947-1950)  
Continues: Hydraulic Laboratory. Bulletin. Series A: Current Hydraulic Laboratory Research in the United States

In 1951 *Hydraulic Research in the United States* became part of the Miscellaneous Publications series, and an annual issue was published, keeping the title *Hydraulic Research in the United States*. In 1969 the series name changed to Special Publications and the frequency of publication of *Hydraulic Research* became biennial. In 1972 the title changed to *Hydraulic Research in the United States and Canada*. Publication of this title ended in 1978.

Miscellaneous Publications 201, 205, 208, 210, 215, 218, 221, 224, 227, 231, 238, 245, 249, 261, 270, 280  
Special Publications 316, 346, 382, 443, 497, 583

### **International Aircraft Standards**

TL671.1.U5  
(1917-1918)

*International Aircraft Standards*, adopted by the International Aircraft Standards Board, were specifications that resulted from testing done at NBS. The classification of specifications covered general inspection and testing instructions, raw materials, fabricated material, and fabricated parts.

### **Ionospheric Predictions**

TK6570.B7U47

No. 1-36 (1963-1965)

Supersedes: Basic Radio Propagation Predictions, CRPL Series D

The CRPL *Ionospheric Predictions* were issued monthly as an aid in determining the best sky-wave frequencies over any transmission path, at any time of day, for average conditions for the month. Issued three months in advance, each issue provided tables of numerical coefficients that defined the functions describing the predicted worldwide distribution of foF2 and M(3000)F2 and maps for each even hour of Universal Time of MUF(Aero)F2 and MUF(4000)F2.

### **IRPL Report**

TK6540.U5

No. 1-35 (1943-June 1946)

Superseded by: CRPL Report

Reports prepared by the Interservice Radio Propagation Laboratory at NBS.

### **Journal of Physical and Chemical Reference Data**

Q199.J65

Vol. 1 (1972)– present

This journal provides critically evaluated physical and chemical property data and critical reviews of measurement techniques. It is not an outlet for original experimental measurements or for review articles of a descriptive or primarily theoretical nature. The National Standard Reference Data System is one source of contributions to the Journal. JPCRD is published by the American Chemical Society and the American Institute of Physics for NIST.

### **JOURNAL OF RESEARCH**

Results of research in science and technology were reported in the *Scientific Papers*. The first 14 volumes of the *Scientific Papers* were issued as the *Bulletin of the Bureau of Standards* and the separate papers were called "Reprints." Results of investigations of materials and methods of testing were reported in the *Technologic Papers*. In July 1928 the *Scientific Papers* and *Technologic Papers* were combined and issued under the title *Bureau of Standards Journal of Research*.

Complete scientific reports of the Bureau's research and development, both experimental and theoretical, in physics, chemistry, and engineering and the results of test and instrumentation activities in these fields were printed in the *Journal of Research*. The subject matter of the reports embraced all fields of work conducted at the Bureau. *Research Papers* were reprints of individual articles appearing in the monthly issues of the *Journal of Research*. They were made available in this form to serve the need of research workers, technical groups, and others for the separate papers relating to the particular subjects in which they cooperated or were interested. In July 1959 the Bureau began publishing the Journal in four separate sections, A, B, C, and D, and the *Research Papers* were discontinued. Issued six times a year.

*Journal of Research of the National Bureau of Standards, Section A. Physics and Chemistry* was of interest primarily to scientists working in these fields. It covered a broad range of physical and chemical research, with major emphasis on standards of physical measurement, fundamental constants, and properties of matter. Issued six times a year.

*Journal of Research of the National Bureau of Standards, Section B. Mathematics and Mathematical Physics* presented studies and compilations designed mainly for the mathematician and the theoretical physicist. Topics in mathematical statistics, theory of experiment design, numerical analysis, theoretical physics and chemistry, logical design and programming of computers and computer systems were covered, together with short numerical tables. In 1967 *Mathematics and Mathematical Physics* changed to *Mathematical Sciences*. Issued quarterly.

*Journal of Research of the National Bureau of Standards, Section C. Engineering and Instrumentation* reported research and development results of interest chiefly to the engineer and the applied scientist. It included many of the new developments in instrumentation resulting from the Bureau's work in physical measurement, data processing, and development of test methods. It also covered some of the work in acoustics, applied mechanics, building research, and cryogenic engineering. Issued quarterly. Ceased publication at end of 1972.

*Journal of Research of the National Bureau of Standards, Section D. Radio Propagation* reported research in radio propagation, communications, and upper atmospheric physics. Topics covered included propagation in ionized media, scattering by turbulence, effect of irregular terrain on propagation, diffraction and scattering by solid obstacles, propagation through time-varying media, surface waves, and antennas. In January 1964, *Radio Propagation* changed to *Radio Science*. Issued six times a year.

*Journal of Research of the National Bureau of Standards, Section D. Radio Science* was published monthly by the National Bureau of Standards in cooperation with the U.S. National Committee of the International Scientific Radio Union (URSI). It served as the principal publication outlet for the research of the NBS Central Radio Propagation Laboratory and the scientific activities of the USNC of URSI; it also carried selected papers from the NBS Radio Standards Laboratory. *Radio Science* presented research papers, as well as occasional survey articles, in radio propagation, communications, and radio science generally. Beginning with the January 1966 issue, *Radio Science* was published by the Environmental Science Services Administration (ESSA) after the transfer of the Central Radio Propagation Laboratory from NBS to ESSA. The scope and coverage remained the same. It continued to be cosponsored by the U.S. National Committee of the International Scientific Radio Union. The title of the journal was changed to simply *Radio Science* with new volume numbering.

In July 1977 Sections A and B were combined under its former title *Journal of Research of the National Bureau of Standards* and issued six times a year.

As of August 23, 1988, the National Bureau of Standards (NBS) became the National Institute of Standards and Technology (NIST) when the Omnibus Trade and Competitiveness Act was signed into law. The title was changed to *Journal of Research of the National Institute of Standards and Technology* with the Volume 93, no. 6 (November-December 1988) issue to reflect the organizational name change.

**Bulletin of the Bureau of Standards**

QC1.U5  
Vol. 1-14 (1904-1919)

**Scientific Papers of the Bureau of Standards**

QC1.U572  
Vol. 15-22 (1919-1928)  
Merged with: Technologic Papers of the Bureau of Standards, to form: Bureau of Standards Journal of Research

**Technologic Papers of the Bureau of Standards**

T1.U4  
Vol. 1-22 (1910-1928)  
Merged with: Scientific Papers of the Bureau of Standards, to form: Bureau of Standards Journal of Research

**Bureau of Standards Journal of Research**

QC1.U52

Vol. 1-12 (1928-1934)

Formed by the union of: Scientific Papers of the Bureau of Standards, and Technologic Papers of the Bureau of Standards

Continued by: Journal of Research of the National Bureau of Standards

**Journal of Research of the National Bureau of Standards**

QC1.U52

Vol. 13-62 (1934-1959)

Continues: Bureau of Standards Journal of Research

Split into four parts and continued by Sections A, B, C, and D

**Journal of Research of the National Bureau of Standards. Section A: Physics and Chemistry**

QC1.U522

Vol. 63A-81A (1959-1977)

Continues in part: Journal of Research of the National Bureau of Standards

Merged with: Journal of Research of the National Bureau of Standards. Section B, to form: Journal of Research of the National Bureau of Standards

**Journal of Research of the National Bureau of Standards. Section B: Mat' ematics and Mathematical Physics**

QA1.U57

Vol. 63B-71B (1959-1967)

Continues in part: Journal of Research of the National Bureau of Standards

Continued by: Journal of Research of the National Bureau of Standards. Section B: Mathematical Sciences

**Journal of Research of the National Bureau of Standards. Section B: Mathematical Sciences**

QA1.U57

Vol. 72B-81B (1968-1977)

Continues: Journal of Research of the National Bureau of Standards. Section B: Mathematics and Mathematical Physics

Merged with: Journal of Research of the National Bureau of Standards. Section A, to form: Journal of Research of the National Bureau of Standards

**Journal of Research of the National Bureau of Standards. Section C: Engineering and Instrumentation**

QC100.U5554

Vol. 63C-76C (1959-1972)

Continues in part: Journal of Research of the National Bureau of Standards

Ceased publication in 1972.

**Journal of Research of the National Bureau of Standards. Section D: Radio Propagation**

QC973.U46

Vol. 63D-67D (1959-1963)

Continues in part: Journal of Research of the National Bureau of Standards

Continued by: Journal of Research of the National Bureau of Standards. Section D: Radio Science

**Journal of Research of the National Bureau of Standards. Section D: Radio Science**

QC973.U46

Vol. 68D-69D (1964-1965)

Continues: Journal of Research of the National Bureau of Standards. Section D: Radio Propagation

Ceased publication by NBS in 1965.

**Journal of Research of the National Bureau of Standards**

QC1.U524

Vol. 82-93 no. 5 (1977-1988)

Formed by the union of its Sections A and B

Continued by: Journal of Research at the National Institute of Standards and Technology

**Journal of Research of the National Institute of Standards and Technology**

QC1.U524

Vol. 93 no. 6 (1988)-present

Continues: Journal of Research of the National Bureau of Standards

**LETTER CIRCULARS**

Letter Circulars 1-1040 are mimeographed, irregularly published lists of Bureau publications and references, and general information concerning specific subjects on which popular interest had been demonstrated by inquiries addressed to the Bureau. With no. 1041 (1966) the Letter Circulars changed from a report format to that of brochures, booklets, and charts. They are still an informal series and not subject to a review process.

**Letter Circular of the Bureau of Standards**

QC100.U5775

No. 1-411 (1921-1934)

**Letter Circular of the National Bureau of Standards**

QC100.U5775

No. 412-1040 (1934-1962)

No. 1041 (1966)-present

**Limitation of Variety Recommendations**

No. 1 (September 1, 1924)

Apparently only one "Elimination of Waste-Limitation of Variety Recommendation" was published (listed in "Publications of the Bureau of Standards, 1901-June 30, 1925," 7th ed. final, pg. 215. Circular no. 24) No mention of this series is made in the "Supplementary List of Publications of the Bureau of Standards, (July 1, 1925, to December 31, 1931)" or any thereafter.

**Mathematical Tables Series**

QA47.U51

No. 1-37 (1939-1946)

The tables (with the exception of MT15) were prepared by the Mathematical Tables Project for the computation of mathematical tables. The project, conducted by the Federal Works Agency, Work Projects Administration (WPA) for the city of New York, was under the sponsorship of, and tables made available through, the National Bureau of Standards. Selected for tabulation were functions of fundamental importance in pure and applied mathematics in the most useful range and interval of the argument. They are of special interest to physicists, engineers, chemists, biologists, mathematicians and others engaged in scientific and technical work.

In 1943 the project was administratively transferred from the WPA to the Bureau, but it remained in New York. When the National Applied Mathematics Laboratories was established at NBS in July 1947, the Mathematical Tables Project moved from New York to Washington, DC and became a part of the NAML's Computation Laboratory.

MT-18, MT-30, and MT-37 were originally printed as part of the series in the "Bulletin of the American Mathematical Society".

MT-19—MT-29, and MT-31—MT-36 were originally printed as part of the series in the "Journal of Mathematics and Physics".

Miscellaneous Publications *see* NIST Special Publications

Monographs *see* Monographs

#### NATIONAL BUREAU OF STANDARDS CIRCULARS

Circulars were compilations of information on various subjects related to the Bureau's scientific, technical, and engineering activities. They included not only the results of Bureau studies, but give data of general interest from other sources.

This series also contained *Recommended Specifications*, *United States Government Specifications*, and *United States Government Master Specifications* formerly issued by the Bureau. These bore a specification number in addition to the Bureau Circular number, but all of these specifications were canceled or superseded by *Federal Specifications*, now formulated by the Federal Specifications Board. The series was discontinued in June 1959 and "circular" material was directed to the *Journal of Research* and the Monograph series.

##### **Circular of Information of the National Bureau of Standards**

QC100.U554

No. 1-4 (1902-1903)

Continued by: Bureau Circular—Department of Commerce and Labor, Bureau of Standards

##### **Bureau Circular—Department of Commerce and Labor, Bureau of Standards**

QC100.U555

No. 1-20 (1903-1909)

Continues: Circular of Information of the National Bureau of Standards

Continued by: Circular of the Bureau of Standards

##### **Circular of the Bureau of Standards**

QC100.U555

No. 21-404 (1910-1934)

Continues: Bureau Circular—Department of Commerce and Labor, Bureau of Standards

Continued by: Circular of the National Bureau of Standards

##### **Circular of the National Bureau of Standards**

QC100.U555

No. 405-459 (1934-1948)

Continues: Circular of the Bureau of Standards

Continued by: National Bureau of Standards Circular

##### **National Bureau of Standards Circular**

QC100.U555

No. 460-603 (1947-1959)

Continues: Circular of the National Bureau of Standards

Superseded by: NBS Monograph

##### **National Bureau of Standards Reports**

Nos. 1000-10,987 (1951-1975)

These were usually preliminary or progress accounting documents intended for use within the government. Before material in the reports was formally published, it was subjected to additional evaluation and review. The reports were often called "graybacks" because of their gray covers.



**NBS-GCR Reports**

QC100.U6N25

70-1 (1970)—present

Grantee/Contractor reports are prepared by non-NIST persons or organizations working under grant or contract from NIST.

**NBS-GCR-ETIP Reports**

73-01—82-101 (1973-1982)

Grantee/Contractor reports prepared by non-NBS persons or organizations working under grant or contract from NBS on subjects specifically for the Experimental Technology Incentives Program.

**NBS Standard**

T1.U44 Vol. 1—vol. 26, no. 15 (October 1955-July 22, 1981)

This publication was the official NBS employee newsletter. All department of commerce individual agency newsletters were discontinued in 1981 as part of the secretary of commerce's goal to develop a more unified and cohesive department. The assistant secretary for administration established an employee newsletter to cover the entire Department of Commerce.

**NIST BUILDING SCIENCE SERIES**

This series disseminates technical information developed at NIST on building materials, components, systems, and whole structures. The series contains research results, test methods, and performance criteria related to the structural and environmental functions and the durability and safety characteristics of building elements and systems.

**Building Science Series**

TA435.U58

No. 0-49 (1965-1974)

Continued by: NBS Building Science Series

**NBS Building Science Series**

TA435.U58

No. 50-165 (1974-1987)

Continues: Building Science Series

Continued by: NIST Building Science Series

**NIST Building Science Series**

TA435.U58

No. 166 (1989)—present

Continues: NBS Building Science Series

**NIST HANDBOOKS**

These are recommended codes of engineering and industrial practice, including safety codes, developed in cooperation with the national organizations and others concerned. In many cases the recommended requirements are given official status through their incorporation in local ordinances by State and municipal regulatory bodies.

**Handbook of the Bureau of Standards**

QC1.U51  
No. 1-18 (1918-1934)  
Continued by: NBS Handbook

**NBS Handbook**

QC1.U51  
No. 19-145 (1934-1986)  
Continues: Handbook of the Bureau of Standards  
Continued by: NIST Handbook

**NIST Handbook**

QC1.U51  
No. 146 (1989)—present  
Continues: NBS Handbook

**NIST MONOGRAPHS**

Monographs are usually contributions to the technical literature which are too lengthy for publication in the *Journal of Research*. They often provide extensive compilations of information on subjects related to the Bureau's technical program. Until July 1959 most of this type of material was published in the Circular series.

**NBS Monograph**

QC100.U556  
No. 1-174 (1959-1986)  
Supersedes: National Bureau of Standards Circular  
Continued by: NIST Monograph

**NIST Monograph**

QC100.U556  
As of 11-20-89, no NIST Monographs have been published.  
Continues: NBS Monograph

**NIST SPECIAL PUBLICATIONS**

The Miscellaneous Publications series included material, which, because of its character or because of its size, did not fit into any of the other regular publication series. Some of these were charts, administrative pamphlets, directories of specifications, annual reports, weights and measures conference reports, and other subjects appropriate to this series. In 1968, the series title changed to Special Publication.

**Miscellaneous Publication—Bureau of Standards**

QC100.U57  
No. 1-132 (1918-1933)  
Continued by: Bureau of Standards Miscellaneous Publication

**Bureau of Standards Miscellaneous Publication**

QC100.U57  
No. 133-144 (1932-1934)  
Continues: Miscellaneous Publication—Bureau of Standards  
Continued by: Miscellaneous Publication—National Bureau of Standards

**Miscellaneous Publication—National Bureau of Standards**

QC100.U57

No. 145-294 (1934-1967)

Continues: Bureau of Standards Miscellaneous Publication

Continued by: NBS Special Publication

**NBS Special Publication**

QC100.U57

No. 295-749 (1968-1988)

Continues: Miscellaneous Publication—National Bureau of Standards

Continued by: NIST Special Publication

**NIST Special Publication**

QC100.U57

No. 750 (1988)—present

Continues: NBS Special Publication

**NIST TECHNICAL NOTES**

This series was initiated in 1959 to supplement the Bureau's regular publications program. Technical Notes provide a means for making available scientific data that are of transient or limited interest.

**NBS Technical Note**

QC100.U5753

No. 1-1321 (1959-1988)

Continued by: NIST Technical Note

Nos. 1250-1299, 1310, 1318 published as NIST Technical Notes.

**NIST Technical Note**

QC100.U5753

No. 1250 (1988)—present

Continues: NBS Technical Note

Nos. 1300-1309, 1311-1317, 1319-1321 published as NBS Technical Notes.

**NISTIR**

This is a special series of interim or final reports on work performed by NIST for outside sponsors (both government and nongovernment).

**NBSIR**

QC100.U56

No. 73-101—88-3836 (1973-1988)

**NISTIR**

QC100.U56

NO. 88-3837 (1988)—present

## NSRDS-NIST

The National Standard Reference Data Series provides quantitative data on the physical and chemical properties of materials, compiled from the world's literature and critically evaluated. It was developed under a worldwide program coordinated by NBS, under authority of the National Standard Data Act (Public Law 90-396). This series supplements the *Journal of Physical and Chemical Reference Data*.

### NSRDS-NBS

QC100.U573

No. 1-73 (1964-1987)

Continued by: NSRDS-NIST

### NSRDS-NIST

QC100.U573

As of 7/7/99, nothing has been published in the NSRDS-NIST series.

Continues: NSRDS-NBS

### Photographic Laboratory Circulars

TR395.U5

No. 1-2 (????-1920)

These were confidential reports of NBS tests for government agencies that were done in the Photographic Laboratory.

### Planning Report

QC100.U5P5

No. 1 (1980)– present

These are internal reports but shared with government or private agencies. The reports are prepared by the NBS/NIST Program Office or by private contractors.

Product Standards *see* Voluntary Product Standards

### PROJECTS AND PUBLICATIONS OF THE APPLIED MATHEMATICS DIVISION: A QUARTERLY REPORT

These were reports on the research and services of Division 11, the National Applied Mathematics Division.

#### Activities in Applied Mathematics

QA27.U5A31

(1946-1947)

Continued by: Projects and Publications of the National Applied Mathematics Laboratories: a Quarterly Report

#### Projects and Publications of the National Applied Mathematics Laboratories: a Quarterly Report

QA27.U5A32

(1947-1954)

Continues: Activities in Applied Mathematics

Continued by: Projects and Publications of the Applied Mathematics Division: a Quarterly Report

**Projects and Publications of the Applied Mathematics Division: a Quarterly Report**

QA27.U5A32

(1954-1964)

Continues: Projects and Publications of the National Applied Mathematics Laboratories: a Quarterly Report

**REFERENCE DATA REPORTS**

This was an informal communication of the National Standard Reference Data System (NSRDS) for the exchange of news and ideas about data centers, publications, meetings, and other activities related to data evaluation and dissemination. It ceased publication in April 1983.

**NSRDS News**

QC100.U57315

Issues for June 1966-May 1973 were originally published in the *Technical News Bulletin*; not published

Nov. 1974-Apr. 1975, Mar., June-Aug. 1976

June 1973—Nov./Dec. 1976

Superseded by: Reference Data Report

**Reference Data Report**

QC100.U57315

Vol. 1-7 (1977-April 1983)

Other title: NSRDS Reference Data Report

Supersedes: NSRDS News

Reports *see* National Bureau of Standards Reports

Scientific Papers of the Bureau of Standards *see* Journal of Research

**Simplified Practice Recommendations**

QC100.U564

No. 1-80 (1922-1927)

(1928-1966)

"Simplified Practice," in this series, meant reduction of excessive variety of manufactured products, or of methods. Simplified Practice Recommendations were records of stock items retained after superfluous variety had been eliminated. These recommendations were developed by voluntary cooperation among manufacturers, distributors, consumers, and others interested, through a regular procedure of the National Bureau of Standards established for that purpose—a procedure designed to insure not only the initial success of a program, but also its continued adjustment to meet changing industrial conditions.

Each printed booklet contained not only the specific recommendation itself, but also its history and development, the names of trade associations, firms, individuals, and others that approved the recommendation, and the personnel of the standing committee in charge of its maintenance and revisions as needed to keep them current with developments. The date from which each recommendation was effective was given. Beginning in 1966 as they were revised, Simplified Practice Recommendations changed to Product Standards and later to Voluntary Product Standards.

**Standards Yearbook**

QC100.U576  
(1927-1933)

This publication gave a summary of progress in the field of standardization in agencies, both governmental and private, throughout the world. The yearbook was originally designed as a companion volume to "Commerce Yearbook." The seven volumes were published as Miscellaneous Publications 77, 83, 91, 106, 119, 133, 139 but titled Standards Yearbook.

**Technical Information on Building Materials for Use in the Design of Low Cost Housing**

TH1.U5  
No. 1-61 (1936-1938)

These releases presented, very briefly, essential facts developed through research work at NBS and refer to longer publications where methods of investigation and results obtained were given in greater detail. They were prepared principally for the guidance of architectural and engineering staffs of federal agencies in the selection of materials for use in low-cost housing.

Technical Notes *see* NIST Technical Notes

Technologic Papers of the Bureau of Standards *see* Journal of Research

**VOLUNTARY PRODUCT STANDARDS**

This series provides requirements for sizes, types, quality and methods for testing various industrial products. These standards are developed cooperatively with interested government and industry groups, provide the basis for common understanding of product characteristics for both buyers and sellers, and are used voluntarily. Voluntary Product Standards include Commercial Standards (material requirements and quality criteria) and Simplified Practice Recommendations (sizes, models, and dimensions of commonly stocked items) revised since 1966. They are developed under procedures published by the Department of Commerce in Part 10, Title 15, of the "Code of Federal Regulations." The purpose of these standards is to establish nationally recognized requirements for products, and to provide all concerned interests with a basis for common understanding of the characteristics of the products. The National Institute of Standards and Technology administers the Voluntary Product Standards program as a supplement to the activities of the private sector standardizing organizations.

In 1979, private standards-writing organizations were encouraged by the Department of Commerce to develop voluntary product standards and it announced the withdrawal of all Voluntary Product Standards sponsored by NBS. Sponsorship of the standards was transferred to other institutions or private standards-writing organizations, or the standards were withdrawn. As of September 1997, three Voluntary Product Standards are still sponsored by NIST, but on a cost-reimbursable basis by private organizations.

**Product Standards**

QC100.U563  
No. 0-13 (1966-1969)  
Continued by: Voluntary Product Standards

**Voluntary Product Standards**

QC100.U563  
No. 14 (1969)—present  
Continues: Product Standards

This page intentionally left blank

---

## APPENDIX I

---

### ORGANIZATIONAL LEVELS OF THE NATIONAL BUREAU OF STANDARDS

MARCH 1950

<b>30</b>	<b>DIRECTOR'S OFFICE</b>	
	Director	Dr. Edward U. Condon
	Assistant to the Director	Hugh Odishaw
	Assistant to the Director	Nicholas E. Golovin
	Associate Director	Dr. Eugene C. Crittenden
	Associate Director	Dr. Wallace R. Brode
<b>31</b>	<b>OFFICE OF SCIENTIFIC PUBLICATIONS</b>	
.1	Library	Hugh Odishaw
.2	Technical Reports	Sarah Ann Jones
.3	Publications	W. Reeves Tilley
		Jesse L. Mathusa
<b>32</b>	<b>OFFICE OF WEIGHTS AND MEASURES</b>	
	Assistant Chief	Ralph W. Smith
		William S. Bussey
<b>1</b>	<b>ELECTRICITY AND OPTICS</b>	
	Assistant Chief	Dr. Francis B. Silsbee
.1	Resistance Measurements	Dr. Kasson S. Gibson
.2	Inductance and Capacitance	Dr. James L. Thomas
.3	Electrical Instruments	Dr. Charles Moon
.4	Magnetic Measurements	Dr. Francis M. Defandorf
.5	Photometry and Colorimetry	Raymond L. Sanford
.6	Optical Instruments	Dr. Kasson S. Gibson
.7	Photographic Technology	Dr. Irvine C. Gardner
.8	Electrochemistry	Raymond Davis
		Dr. George W. Vinal
<b>2</b>	<b>METROLOGY</b>	
	Assistant Chief	Dr. Wilmer Souder
.1	Length	David R. Miller
.2	Mass	Dr. Lewis V. Judson
.3	Time	Lloyd B. Macurdy
.4	Capacity, Density and Fluid Meters	Horace A. Bowman (Acting)
.6	Thermal Expansion	Howard S. Bean
.7	Dental Materials	Dr. Peter Hidnert
.8	Scales	Dr. Irl C. Schoonover
.9	Gage	H. Haig Russell
		David R. Miller
<b>3</b>	<b>HEAT AND POWER</b>	
.1	Temperature Measurements	Dr. Ferdinand G. Brickwedde
.2	Thermodynamics	Dr. Raymond E. Wilson
.3	Cryogenics	Dr. Ferdinand G. Brickwedde
.4	Engines and Lubrication	Russell B. Scott
.5	Engine Fuels	Samuel A. McKee
.6	Combustion	Dr. Frank L. Howard (Acting)
		Dr. Ernest F. Fiock



- 4 ATOMIC AND RADIATION PHYSICS**  
 Assistant Chief  
 Radioactivity Consultant  
 Stable Tracers Consultant
- 4A Atomic Physics Laboratory**
- .1 Spectroscopy
  - .2 Radiometry
  - .3 Mass Spectrometry
  - .4 Physical Electronics
  - .5 Electron Physics
  - .6 Atomic Physics
  - .7 Neutron Measurements
- 4R Radiation Physics Laboratory**
- .8 Nuclear Physics
  - .9 Radioactivity
  - .10 X-Rays
  - .11 Betatron
  - .12 Nucleonic Instrumentation
  - .13 Radiological Equipment
- 5 CHEMISTRY**  
 Assistant Chief
- .1 Paint, Varnish and Lacquer
  - .2 Surface Chemistry
  - .3 Organic Chemistry
  - .4 Analytical Chemistry
  - .5 Platinum Metals and Pure Substances
  - .6 Electrodeposition
  - .7 Gas Chemistry
  - .8 Physical Chemistry
  - .9 Thermochemistry and Hydrocarbons
  - .10 Spectrochemistry
- 6 MECHANICS**
- .1 Sound
  - .2 Mechanical Instruments
  - .3 Aerodynamics
  - .4 Engineering Mechanics
  - .5 Hydraulics
- 7 ORGANIC AND FIBROUS MATERIALS**  
 Assistant Chief  
 Consultant
- .1 Rubber
  - .2 Textiles
  - .3 Paper
  - .4 Leather
  - .5 Testing and Specifications
  - .7 Organic Plastics
- 8 METALLURGY**  
 Assistant Chief
- .1 Optical Metallurgy
  - .2 Thermal Metallurgy
- Dr. Robert D. Huntoon  
 Lauriston S. Taylor  
 Dr. Leon F. Curtiss  
 Dr. Fred L. Mohler  
 Dr. Robert D. Huntoon  
 Dr. William F. Meggers  
 Dr. Curtis J. Humphreys  
 Dr. Fred L. Mohler  
 Dr. Willard H. Bennet  
 Dr. Ladislaus L. Marton  
 Dr. John A. Hipple  
 Dr. Leon F. Curtiss  
 Lauriston S. Taylor  
 Dr. Ugo Fano  
 Lauriston S. Taylor (Acting)  
 Harold O. Wyckoff  
 Herman W. Koch  
 Harold O. Wyckoff (Acting)  
 Dr. Scott W. Smith
- Dr. Edward W. Wichers  
 Dr. William Blum  
 Eugene F. Hickson  
 Dr. James I. Hoffman  
 W. Harold Smith  
 Harry A. Bright  
 Dr. Raleigh Gilchrist  
 Dr. William Blum  
 Elmer R. Weaver  
 Dr. Edgar R. Smith  
 Dr. Frederick D. Rossini  
 Bourdon F. Scribner
- Dr. Walter Ramberg  
 Dr. Richard K. Cook  
 Dr. William G. Brombacher  
 Dr. Galen B. Schubauer  
 Bruce L. Wilson  
 Herbert N. Eaton
- Dr. Archibald T. McPherson  
 Dr. Gordon M. Kline  
 Dr. Robert Simha  
 Dr. Lawrence A. Wood  
 William D. Appel  
 Bourdon W. Scribner  
 Everett L. Wallace  
 Dr. Robert D. Stiehler  
 Dr. Gordon M. Kline
- Dr. John G. Thompson  
 William F. Roeser  
 George A. Ellinger  
 Thomas G. Digges

- |           |  |                               |
|-----------|--|-------------------------------|
| .3        | Mechanical Metallurgy                  | William F. Roeser             |
| .4        | Chemical Metallurgy                    | Harold E. Cleaves             |
| .5        | Experimental Foundry                   | Alexander I. Krynskiy         |
| .6        | Underground Corrosion                  | Dr. Irving A. Denison         |
| <b>9</b>  | <b>MINERAL PRODUCTS</b>                | Dr. Herbert Insley            |
| .1        | Porcelain and Pottery                  | Roman F. Geller               |
| .2        | Glass                                  | Clarence H. Hahner            |
| .3        | Refractories                           | Raymond A. Heindl             |
| .4        | Enameled Metals                        | William N. Harrison           |
| .5        | Building Stone                         | Daniel W. Kessler             |
| .6        | Concreting Materials                   | Raymond L. Blaine             |
| .7        | Constitution and Microstructure        | Howard F. McMurdie            |
| .8        | Chemistry of Mineral Products          | Dr. Lansing S. Wells          |
| <b>10</b> | <b>BUILDING TECHNOLOGY</b>             | Douglas E. Parsons            |
|           | Assistant Chief                        | George N. Thompson            |
| .1        | Structural Engineering                 | Douglas E. Parsons            |
| .2        | Fire Protection                        | Nolan D. Mitchell             |
| .3        | Heating and Air Conditioning           | Richard S. Dill               |
| .4        | Exterior and Interior Covering         | Dr. Hubert R. Snoke           |
| .5        | Codes and Specifications               | George N. Thompson            |
| <b>11</b> | <b>APPLIED MATHEMATICS</b>             | Dr. John H. Curtiss           |
|           | Assistant Chief                        | Dr. Edward W. Cannon          |
| .1        | Numerical Analysis                     | Dr. J. Berkley Rosser (UCLA)  |
| .2        | Computation                            | Dr. Franz L. Alt (Acting)     |
| .3        | Statistical Engineering                | Dr. Churchill Eisenhart       |
| .4        | Machine Development                    | Dr. Edward W. Cannon (Acting) |
| <b>12</b> | <b>COMMODITY STANDARDS</b>             | Edwin W. Ely                  |
|           | Assistant Chief                        | Floyd W. Reynolds             |
| .1        | Metal and Ceramic Products             | George Schuster               |
| .2        | Textiles and Apparel                   | Herbert A. Ehrman             |
| .3        | Mechanical Equipment                   | James W. Medley               |
| .4        | Packaging                              | William E. Braithwaite        |
| .5        | Chemical Products                      | Floyd W. Reynolds             |
| <b>13</b> | <b>ELECTRONICS AND ORDNANCE</b>        | Dr. Allen V. Astin            |
|           | Assistant Chief for Ordnance           | Wilbur S. Hinman, Jr.         |
|           | Assistant Chief for Aerophysics        | Dr. Harold K. Skramstad       |
|           | Electronics Consultant                 | Dr. Robert D. Huntoon         |
|           | Electronics Consultant                 | Dr. Chester H. Page           |
|           | <b>Electronic Standards Laboratory</b> |                               |
| .1        | Engineering Electronics                | Joseph G. Reid, Jr.           |
| .2        | Electron Tubes                         | Dr. John E. White             |
| .3        | Electronic Computers                   | Dr. Samuel N. Alexander       |
|           | <b>Ordnance Development Laboratory</b> | Wilbur S. Hinman, Jr.         |
| .4        | Ordnance Research                      | Dr. Harold Goldberg           |
| .5        | Ordnance Mechanics                     | Jacob Rabinow                 |
| .6        | Ordnance Electronics                   | P. Anthony Guarino            |
| .7        | Ordnance Engineering                   | Myron G. Domsitz              |
| .8        | Ordnance Tests                         | Theodore B. Godfrey           |

	<b>Guided Missile Branch</b>	
	.9 Missile Dynamics	Ralph A. Lamm
	.10 Missile Intelligence	Dr. Harold K. Skramstad
	.11 Missile Engineering	Dr. Fred S. Atchison
	.12 Missile Instrumentation	Ralph A. Lamm
	.13 Technical Services	William A. Wildhack James D. McLean (Acting)
<b>14</b>	<b>CENTRAL RADIO PROPAGATION LABORATORY</b>	
	Assistant Chief	Dr. Newbern Smith
	Assistant Chief	Alvin G. McNish
	Microwave Research Consultant	Kenneth A. Norton
	<b>Ionospheric Research Laboratory</b>	Dr. Thomas J. Carroll, Jr.
	.1 Upper Atmosphere Research	Alvin G. McNish
	.5 Ionospheric Research	Ross Bateman
	.7 Field Operations	Henry P. Hutchinson
	<b>Systems Research Laboratory</b>	
	.3 Regular Propagation Services	Walter B. Chadwick
	.4 Frequency Utilization Research	Kenneth A. Norton
	.6 Tropospheric Propagation Research	Jack W. Herbstreit (Acting)
	<b>Measurement Standards Laboratory</b>	
	.8 High Frequency Standards	William D. George
	.9 Microwave Standards	Dr. Harold Lyons
<b>M</b>	<b>BUDGET AND MANAGEMENT</b>	
	.1 Budget	Herbert E. Weifenbach
	.2 Management Planning	Edward E. Upperman
	.3 Procurement	Wilbur W. Bolton, Jr.
	.4 Property Management	Charles B. Kipps
	.5 Records and Communications	George B. Kefover
	.6 Accounting	Robert W. Lamberson
	.7 Special Services	Clinton G. Hall Frank D. Moncure (Acting)
<b>P</b>	<b>PERSONNEL</b>	
	Assistant Chief	Raymond L. Randall
	.1 Recruitment and Placement	William C. Fewell
	.2 Operations	Raymond L. Randall
	.3 Classification	Jessie B. Berkley
	.4 Medical Office	Lawrence L. Epperson
	.5 Education and Training	Dr. William Frank Joseph Hilsenrath
<b>E</b>	<b>PLANT</b>	
	Assistant Chief	William J. Ellenberger
	.1 Power Plant	Oscar L. Britt
	.2 Electrical Shop	Grover F. Hamby
	.3 Piping Shop	George V. Hall
	.4 Carpenter Shop	Raymond A. Watson
	.5 Paint Shop	Paul J. Robinson
	.6 General Service	Raymond E. Mothershead
	.7 Garage	Frank A. Peters
	.8 Guard	Harry C. Magruder
	.9 Grounds	Herman B. Burke
	.10 Janitorial	William R. David
	.11 Refrigeration and Air Conditioning	Adeeb J. Neam
	.12 Administrative and Engineering Office	Elridge G. Burke Vacant

**S****SHOPS**

- Assistant Chief
- Shop Superintendent
- .1 Design and Drafting
- .2 Instrument Shop No. 1
- .3 Instrument Shop No. 2
- .4 Instrument Shop No. 3
- .5 Instrument Shop No. 4
- .6 Instrument Shop No. 5
- .7 Welding and Sheet Metal Shop
- .8 Woodworking Shop
- .9 Shop Tools
- .10 Maintenance
- .11 Glassblowing Shop
- .12 Metals Storeroom

Paul S. Ballif  
 Winfield L. Drissel  
 John L. Hutton  
 Richard J. Hanrahan  
 Henry N. Philo  
 George A. Rheinbold  
 George W. Bicking, Jr.  
 Charles W. Hyder  
 Andrew J. Altman  
 Edward G. Clark  
 Paul D. Huntley  
 Lewis H. Brigham  
 Winfield L. Drissel  
 Leonardo Testa  
 James E. Mallory

**FIELD STATIONS****1****ELECTRICITY AND OPTICS**

Lamp Inspector, Brookline, MA  
 George Schnitzler

**2****METROLOGY**

Master Scale Depot, Clearing, IL  
 H. Haig Russell, Chief

**9****MINERAL PRODUCTS**

Cement Testing and Inspection Station, Allentown, PA  
 William N. Moyer, Chief

Cement Testing and Inspection Station, Riverside Cement Co., Riverside, CA  
 Donald N. Evans, Chief

Cement Testing and Inspection Station, Permanente Cement Co., Permanente, CA  
 Martin Defore, Chief

Cement Testing and Inspection Station, Sanitary Engineering Building, University of Washington,  
 Seattle, WA  
 Frank N. Winblade, Chief

Cement and Concrete Materials Testing Station, Denver, CO  
 Orson H. Cox, Chief

Materials Testing Station, San Francisco, CA  
 Otto C. Marek (Acting) Chief

**11****APPLIED MATHEMATICS**

Institute for Numerical Analysis, University of California at Los Angeles, Los Angeles, CA  
 Dr. J. Berkley Rosser (Acting) Chief

**13****ELECTRONICS**

Blossom Point Proving Ground, La Plata, MD  
 Adrian P. Suttan, Chief

Warren Grove Test Field, Warren Grove, Tuckerton, NJ  
 William A. Wildhack, Chief

14

**CENTRAL RADIO PROPAGATION LABORATORY**

Radio Propagation Field Station, Anchorage, AK  
Vernon H. Goerke, Chief

Radio Propagation Field Station, Point Barrow, AK  
Lloyd A. Lohr, Chief

Radio Propagation Field Station, Island of Guam  
Herschel C. Carmichael, Chief

Radio Propagation Field Station, Puunene, Maui, Territory of Hawaii  
Leo W. Honea, Chief

Radio Propagation Field Station, Palmyra Island, Honolulu, Territory of Hawaii  
Stephen S. Barnes, Chief (Acting)

Radio Propagation Field Station, Ramey Air Force Base, Puerto Rico  
Theodore R. Gilliland, Chief

Radio Propagation Field Station, Trinidad, B. W. I.  
Richard F. Carle, Chief

Radio Propagation Field Station, White Sands Proving Ground, Las Cruces, NM  
Earl E. Ferguson, Chief

Radio Propagation Field Station, Ft. Belvoir, VA  
Edward J. Wiewara, Chief

Radio Propagation Laboratory, Sterling, VA  
Victor C. Pineo, Chief

Radio Transmitting Station, Beltsville, MD  
Gordon H. Lester, Chief

MAY 1953

- 30 DIRECTOR'S OFFICE**  
Director  
Associate Director for Research  
Associate Director for Testing  
Associate Director for Ordnance  
\* Director Corona Laboratories  
Assistant Director for Administration  
Deputy Assistant Director for Administration  
Assistant to the Director  
Consultant
- 31 OFFICE OF SCIENTIFIC PUBLICATIONS**  
.1 Library  
.2 Technical Reports  
.3 Publications
- 32 OFFICE OF WEIGHTS AND MEASURES**  
Assistant Chief  
Chief Scale Section
- 33 OFFICE OF BASIC INSTRUMENTATION**  
Assistant to the Chief
- 1 ELECTRICITY**  
Assistant Chief  
.1 Resistance and Reactance  
.3 Electrical Instruments  
.4 Magnetic Measurements  
.5 Applied Electricity  
.8 Electrochemistry
- 2 OPTICS AND METROLOGY**  
Assistant Chief  
Assistant to the Chief  
.1 Photometry and Colorimetry  
.2 Optical Instruments  
.3 Photographic Technology  
.4 Length  
.5 Gage
- 3 HEAT AND POWER**  
.1 Temperature Measurements  
.2 Thermodynamics  
.3 Cryogenics  
.4 Engines and Lubrication  
.5 Engine Fuels  
\* .6 Cryogenic Engineering
- Dr. Allen V. Astin  
Dr. Wallace R. Brode  
Dr. Archibald T. McPherson  
Wilbur S. Hinman, Jr.  
Dr. Robert D. Huntoon (Corona)  
Nicholas E. Golovin  
Robert S. Walleigh  
Hugh Odishaw  
Dr. Eugene C. Crittenden
- Hugh Odishaw  
Sarah Ann Jones  
W. Reeves Tilley  
Jesse L. Mathusa
- William S. Bussey  
Malcolm W. Jensen  
H. Haig Russell
- William A. Wildhack  
Edward C. Lloyd
- Dr. Francis B. Silsbee  
Raymond L. Sanford  
Dr. James L. Thomas  
Dr. Francis M. Defandorf  
Raymond L. Sanford  
John L. Dalke  
Dr. Walter J. Hamer
- Dr. Irvine C. Gardner  
Dr. Kasson S. Gibson  
Leroy W. Tilton  
Dr. Kasson S. Gibson  
Dr. Irvine C. Gardner  
Raymond Davis  
Dr. Lewis V. Judson  
Irvin H. Fullmer (Acting)
- Dr. Ferdinand G. Brickwedde  
Dr. Raymond E. Wilson (Acting)  
Dr. Raymond E. Wilson  
Dr. Charles W. Beckett  
Dr. John R. Pellam  
James F. Swindells (Acting)  
Dr. Frank L. Howard  
Russell B. Scott (Boulder)

- 4 ATOMIC AND RADIATION PHYSICS**  
 Stable Tracer Consultant  
 Radioactive Tracer and Radioactivity Consultant
- 4A Atomic Physics Laboratory**
- .1 Spectroscopy
  - .2 Radiometry
  - .3 Mass Spectrometry
  - .4 Solid State Physics
  - .5 Electron Physics
  - .6 Atomic Physics
  - .7 Neutron Measurements
  - \* .15 Infrared Spectroscopy
- 4R Radiation Physics Laboratory**
- .8 Nuclear Physics
  - .9 Radioactivity
  - .10 X-Rays
  - .11 Betatron
  - .12 Nucleonic Instrumentation
  - .13 Radiological Equipment
  - .14 Radiation Instruments Branch,  
 Atomic Energy Commission
- 5 CHEMISTRY**  
 Assistant Chief
- .1 Organic Coatings
  - .2 Surface Chemistry
  - .3 Organic Chemistry
  - .4 Analytical Chemistry
  - .5 Inorganic Chemistry
  - .6 Electrodeposition
  - .7 Gas Chemistry
  - .8 Physical Chemistry
  - .9 Thermochemistry
  - .10 Spectrochemistry
  - .11 Pure Substances
- 6 MECHANICS**  
 Assistant Chief  
 Consultant
- .1 Sound
  - .2 Mechanical Instruments
  - .3 Aerodynamics
  - .4 Engineering Mechanics
  - .5 Hydraulics
  - .6 Mass
  - .7 Capacity, Density and Fluid Meters
- 7 ORGANIC AND FIBROUS MATERIALS**  
 Assistant Chief  
 Consultant
- .1 Rubber
  - .2 Textiles
  - .3 Paper
- Dr. Lauriston S. Taylor  
 Dr. Fred L. Mohler  
 Dr. Leon F. Curtiss
- Dr. William F. Meggers  
 Dr. Earle K. Plyler  
 Dr. Fred L. Mohler  
 Dr. Robert G. Breckenridge  
 Dr. Ladislaus L. Marton  
 Vacant  
 Dr. Leon F. Curtiss  
 Dr. Curtis J. Humphreys (Corona)  
 Dr. Harold O. Wyckoff  
 Dr. Ugo Fano  
 Dr. Wilfrid B. Mann  
 Dr. Harold O. Wyckoff  
 Dr. Herman W. Koch  
 Dr. Louis Costrell (Acting)  
 Dr. Scott W. Smith
- Robert L. Butenhoff
- Dr. Edward W. Wichers  
 Dr. James I. Hoffman  
 Paul T. Howard  
 Dr. James I. Hoffman  
 W. Harold Smith  
 Harry A. Bright  
 Dr. Raleigh Gilchrist  
 Dr. Abner Brenner  
 Elmer R. Weaver  
 Dr. Edgar R. Smith  
 Edward J. Prosen  
 Bourdon F. Scribner  
 Dr. Charles P. Saylor
- Dr. Walter Ramberg  
 Dr. William G. Brombacher  
 Dr. Wilmer Souder  
 Dr. Richard K. Cook  
 Dr. William G. Brombacher  
 Dr. Galen B. Schubauer  
 Bruce L. Wilson  
 Vacant  
 Lloyd B. Macurdy  
 Howard S. Bean
- Dr. Gordon M. Kline  
 Dr. Irl C. Schoonover  
 Dr. Wilmer Souder  
 Dr. Lawrence A. Wood  
 William D. Appel  
 Dr. Robert B. Hobbs

- .4 Leather
  - .5 Testing and Specifications
  - .6 Polymer Structure
  - .7 Organic Plastics
  - .8 Dental Research
- 8 METALLURGY**
- .1 Thermal Metallurgy
  - .2 Chemical Metallurgy
  - .3 Mechanical Metallurgy
  - .4 Corrosion
- 9 MINERAL PRODUCTS**  
Assistant Chief
- .1 Porcelain and Pottery
  - .2 Glass
  - .3 Refractories
  - .4 Enameled Metals
  - .6 Concreting Materials
  - .7 Constitution and Microstructure
  - .8 Chemistry of Mineral Products
- 10 BUILDING TECHNOLOGY**  
Assistant Chief  
Consultant  
Consultant  
Consultant
- .1 Structural Engineering
  - .2 Fire Protection
  - .3 Heating and Air Conditioning
  - .4 Floor, Roof and Wall Coverings
  - .5 Codes and Specifications
- 11 APPLIED MATHEMATICS**  
Assistant Chief
- \* .1 Numerical Analysis
  - .2 Computation
  - .3 Statistical Engineering
  - .4 Machine Development
- 12 ELECTRONICS**
- .1 Engineering Electronics
  - .2 Electron Tubes
  - .3 Electronic Computers
  - .4 Electronic Instrumentation
  - .5 Production Electronics
- 13 ORDNANCE DEVELOPMENT**  
Assistant Chief
- .1
  - .2
  - .3
- Everett L. Wallace  
Dr. Robert D. Stiehler  
Dr. Irl C. Schoonover  
Frank W. Reinhart  
William T. Sweeney
- Dr. John G. Thompson  
Thomas G. Digges  
LeRoy L. Wyman  
John A. Bennett  
George A. Ellinger
- Dr. Herbert Insley  
Clarence H. Hahner  
Roman F. Geller  
Clarence H. Hahner  
Raymond A. Heindl  
William N. Harrison  
Raymond L. Blaine  
Howard F. McMurdie  
Dr. Lansing S. Wells
- Douglas E. Parsons  
George N. Thompson  
William F. Roeser  
Nolan D. Mitchell  
John W. McBurney  
Douglas E. Parsons  
Dr. Alexander F. Robertson  
Richard S. Dill  
Dr. Hubert R. Snoke  
George N. Thompson
- Dr. Franz L. Alt (Acting)  
Dr. Edward W. Cannon  
Dr. Derrick H. Lehmer (UCLA)  
John Todd  
Dr. Churchill Eisenhart  
Dr. Edward W. Cannon
- Joseph G. Reid, Jr.  
Dr. Paul J. Selgin  
Dr. Robert T. Young  
Dr. Samuel N. Alexander  
Carroll Stansbury  
Robert L. Henry
- Myron G. Domsitz  
P. Anthony Guarino  
Paul E. Landis  
Leo Rubinowitz  
Harvey A. Pratt



.4		Dr. Roger W. Curtis
.5		Philip J. Franklin
.6		P. Anthony Guarino
.8		Theodore B. Godfrey
<b>14</b>	<b>CENTRAL RADIO PROPAGATION LABORATORY</b>	
	Assistant Chief	Dr. Newbern Smith
*	Assistant Chief	Alvin G. McNish
.3	Regular Propagation Services	Kenneth A. Norton (Boulder)
	<b>Ionospheric Research Laboratory</b>	Walter B. Chadwick
.1	Upper Atmosphere Research	Alvin G. McNish
.5	Ionospheric Research	Ross Bateman
	<b>Systems Research Laboratory</b>	
*	.4 Frequency Utilization Research	Kenneth A. Norton (Boulder)
*	.6 Tropospheric Propagation	Jack W. Herbstreit (Boulder)
	<b>Measurement Standards Laboratory</b>	
.8	High Frequency Standards	William D. George
.9	Microwave Standards	Dr. Harold Lyons
<b>15</b>	<b>MISSILE DEVELOPMENT</b>	
	Washington Office	Ralph A. Lamm (Corona)
.6	Combustion	Dr. Ernest F. Fiock
<b>16</b>	<b>ELECTROMECHANICAL ORDNANCE</b>	
	Assistant Chief	Jacob Rabinow
.1		Maurice Apstein
.2		Laurence M. Andrews
.3		Thomas E. Tuccinardi
.4		William M. Piper
.5		Milton Lipnick (Acting)
.6		William M. Piper (Acting)
.7		Walter A. Hereth (Acting)
		Israel Rotkin (Acting)
<b>17</b>	<b>ORDNANCE ELECTRONICS</b>	
	Deputy Chief	Harold Goldberg
	Assistant Chief	Donald P. Burcham
<b>17A</b>	<b>Research Branch</b>	Benjamin L. Sander
.1		Dr. Merril F. Distad
.2		Henry P. Kalmus
.3		Dr. Hans W. Kohler
.4		Milton Sanders
.5		John W. Seaton
		Franklin M. Fletcher
<b>17B</b>	<b>Development Branch</b>	Arthur E. Newlon
.6		Frank R. Edgarton
.7		Joseph Kaufman
.8		Joseph P. Spalding (Acting)

<b>40</b>	<b>ACCOUNTING</b> Deputy Chief .1 Accounting Operations .2 Internal Audit .3 Contract Audit	Gordon D. Horsburgh Willard K. Duckworth Vacant Joseph P. Gibala Edward E. Upperman
<b>41</b>	<b>PERSONNEL</b> Assistant Chief .1 Board of Civil Service Examiners .2 Recruitment and Placement .3 Classification .4 Employee Relations .5 Operations and Procedures .6 Medical Office	George R. Porter Frankie R. Keyser Edith N. Fimple Karl L. Hafen Charles V. Ramey Ruth B. Armsby Helen V. Courtney Dr. Charles P. Waite
<b>42</b>	<b>ADMINISTRATIVE SERVICES</b> Assistant Chief .1 Records and Communications .2 Special Services .3 Janitorial Services .4 Guard Services .5 Transportation Services .6 Deputy Security Officer .7 Test Administration	Harry P. Dalzell Richard D. Althaus Robert W. Lamberson Robert P. Conrad Robert C. Howey Vacant Charles W. Anderson Harry P. Dalzell Randolph K. Artz
<b>43</b>	<b>SHOPS</b> Assistant Chief .1 Instrument Shop No. 1 .2 Instrument Shop No. 2 .3 Instrument Shop No. 3 .4 Instrument Shop No. 4 .5 Instrument Shop No. 5 .6 Instrument Shop No. 6 .7 Welding and Sheet Metal Shop .8 Ordnance Development Branch Shop .9 Tool Crib .10 Maintenance .11 Glassblowing Shop	Frank P. Brown Winfield L. Drissel David G. Kennedy Louis K. Germand George A. Rheinbold Norman C. Pines Robert E. Ward Andrew J. Altman Terrell C. Freemon August C. Kus Lewis H. Brigham Winfield L. Drissel Leonardo Testa
<b>44</b>	<b>SUPPLY</b> .3 Procurement .4 Property Management	George B. Kefover Charles B. Kipps Fred H. Johncox
<b>45</b>	<b>MANAGEMENT PLANNING STAFF</b> Assistant Chief	Ivan Asay Eldon E. Sweezy
<b>46</b>	<b>BUDGET STAFF</b>	Wilbur W. Bolton, Jr.
<b>50</b>	<b>PLANT</b> Assistant Chief .1 Power Plant .2 Electric Shop .3 Piping Shop	Charles A. Dieman Clarence B. Crane Arthur C. Ramm George V. Hall Raymond A. Watson

.4	Construction Shop	John A. King
.5	Paint Shop	Howell C. Walker
.6	Labor Services	Roy B. Powell
.7	Metal Shop	Charles Needham
.9	Grounds	William R. David
.11	Refrigeration and Air Conditioning	James S. Powers (Acting)

**CORONA LABORATORIES**

<b>70</b>	<b>DIRECTOR</b>	Dr. Robert D. Huntoon
.1	Technical Publications Officer	J. Wray Smith
.2	Security Officer	Norman J. Lipking
.3	Survey Projects	Fred S. Atchison
<b>71</b>	<b>EXECUTIVE OFFICER</b>	Samuel W. J. Welch
.1	Personnel	Jack C. Evans
.2	Fiscal and Supply	James J. Mooney
.4	Shops	James D. McLean
.5	Plant	Norman J. Lipking
<b>4.15</b>	<b>Infra-red Spectroscopy Section</b>	Curtis J. Humphreys
<b>15</b>	<b>MISSILE DEVELOPMENT</b>	Ralph A. Lamm
	Assistant Chief	Dr. Harold K. Skramstad
.1	Missile Engineering	Howard F. Gemmell
.2	Missile Dynamics	John A. Hart
.3	Missile Intelligence	Harvey W. Lance
.4	Missile Instrumentation	Dr. Myron G. Pawley
.5	Missile Evaluation	Gerard R. Sams
.6	Combustion Section	Dr. Ernest F. Fiock (Washington)
<b>23</b>	<b>CORONA ORDNANCE BRANCH</b>	Harold A. Thomas
.1	Systems Design	Harold A. Thomas
.2	Systems Evaluation	Lawrence E. Brown
.3	Electronic Development	Evan G. Lapham
.4	Electromechanical Development	

\* Laboratories located in Boulder, Colorado, Los Angeles, California, and Corona, California.

**FIELD STATIONS**

<b>2</b>	<b>OPTICS AND METROLOGY</b>	
	Lamp Inspector, Brookline, MA	
<b>3</b>	<b>HEAT AND POWER</b>	
	3.6 Cryogenic Engineering, Boulder, CO	Russell B. Scott

- 9 MINERAL PRODUCTS**  
**9.06 Concreting Materials**  
 Allentown, PA  
 Denver, CO  
 Kansas City, MO  
 San Francisco, CA  
 Seattle, WA
- 11 APPLIED MATHEMATICS**  
**11.01 Numerical Analysis**, The Institute for Numerical Analysis, University of California at  
 Los Angeles  
 Director of Research Dr. Derrick H. Lehmer  
 Assistant Director Dr. Magnus R. Hestenes  
 Assistant to the Director (Admin.) Albert S. Cahn, Jr.
- 13 ORDNANCE DEVELOPMENT**  
 Blossom Point Proving Ground, La Plata, MD
- 14 CENTRAL RADIO PROPAGATION LABORATORY**  
 Radio Propagation Field Station, Anchorage, AK  
 Radio Propagation Field Station, Point Barrow, AK  
 Radio Propagation Field Station, Guam Island  
 Radio Propagation Field Station, Puunene, Maui, Territory of Hawaii  
 Radio Propagation Field Station, Ramey Air Force Base, Puerto Rico  
 Cheyenne Mountain Field Station, Colorado Springs, CO  
 Radio Field Station, Ft. Belvoir, VA  
 Radio Propagation Laboratory, Sterling, VA  
 Radio Transmitting Station, Beltsville, MD  
 National Bureau of Standards, Boulder CO  
 Radio Propagation Field Station, Bluie West-1, Greenland  
 Radio Propagation Field Station, Fort Gulick, Panama Canal Zone
- 17 NATIONAL BUREAU OF STANDARDS**  
 NBS Field Station, Naval Air Missile Test Center, Point Mugu, Oxnard, CA  
 NBS Field Station, Naval Ordnance Test Station, China Lake, Inyokern, CA  
 NBS Field Station, White Sands Proving Ground, Las Cruces, NM  
 NBS Field Station, Consolidated Vultee Aircraft Corporation, Pomona, CA
- 32 OFFICE OF WEIGHTS AND MEASURES**  
 NBS Master Railway Track Scale Depot, Clearing, IL

**MARCH 1954**

<b>30</b>	<b>DIRECTOR'S OFFICE</b>	
	Director	Dr. Allen V. Astin
	Associate Director for Chemistry	Dr. Wallace R. Brode
	Associate Director for Physics	Dr. Robert D. Huntoon
	Associate Director for Testing	Dr. Archibald T. McPherson
	Assistant Director for Administration	Nicholas E. Golovin
*	Director, Boulder Laboratories	Dr. Frederick W. Brown (Boulder)
	Consultant to the Director	Dr. Eugene C. Crittenden
	Consultant to the Director	Dr. Leon F. Curtiss
	Consultant to the Director	Dr. Chester H. Page
<b>31</b>	<b>OFFICE OF SCIENTIFIC PUBLICATIONS</b>	
.1	Library	Sarah Ann Jones
.2	Technical Reports	W. Reeves Tilley
.3	Publications	Jesse L. Mathusa
<b>32</b>	<b>OFFICE OF WEIGHTS AND MEASURES</b>	
	Assistant Chief	William S. Bussey
		Malcolm W. Jensen
<b>33</b>	<b>OFFICE OF BASIC INSTRUMENTATION</b>	
	Assistant to the Chief	William A. Wildhack
<b>1</b>	<b>ELECTRICITY</b>	
	Assistant Chief	Dr. Francis B. Silsbee
.1	Resistance and Reactance	Raymond L. Sanford
.3	Electrical Instruments	Dr. James L. Thomas
.4	Magnetic Measurements	Dr. Francis M. Defandorf
.8	Electrochemistry	Raymond L. Sanford
		Dr. Walter J. Hamer
<b>2</b>	<b>OPTICS AND METROLOGY</b>	
	Assistant Chief	Dr. Irvine C. Gardner
	Assistant to the Chief	Dr. Kasson S. Gibson
.1	Photometry and Colorimetry	Leroy W. Tilton
.2	Optical Instruments	Dr. Kasson S. Gibson
.3	Photographic Technology	Dr. Francis E. Washer
.4	Length	Raymond Davis
.5	Engineering Metrology	Dr. Lewis V. Judson
		Irvin H. Fullmer
<b>3</b>	<b>HEAT AND POWER</b>	
.1	Temperature Measurements	Dr. Ferdinand G. Brickwedde
.2	Thermodynamics	Dr. Raymond E. Wilson
.3	Cryogenics	Dr. Charles W. Beckett
.4	Engines and Lubrication	Dr. John R. Pellam
.5	Engine Fuels	James F. Swindells (Acting)
*	.6 Cryogenic Engineering	Dr. Frank L. Howard
		Russell B. Scott (Boulder)
<b>4</b>	<b>ATOMIC AND RADIATION PHYSICS</b>	
<b>4A</b>	<b>Atomic Physics Laboratory</b>	Dr. Lauriston S. Taylor
.1	Spectroscopy	Dr. William F. Meggers
.2	Radiometry	Dr. Earle K. Plyler

- |           |   |                                  |
|-----------|---|----------------------------------|
| .3        | Mass Spectrometry   | Dr. Fred L. Mohler               |
| .4        | Solid State Physics                                       | Dr. Robert G. Breckenridge       |
| .5        | Electron Physics  | Dr. Ladislaus L. Marton          |
| .6        | Atomic Physics  | Dr. Lauriston S. Taylor (Acting) |
| <b>4R</b> | <b>Radiation Physics Laboratory</b>                       | Dr. Harold O. Wyckoff            |
| .8        | Nuclear Physics   | Dr. Ugo Fano                     |
| .9        | Radioactivity   | Dr. Wilfrid B. Mann              |
| .10       | X-Rays  | Dr. Harold O. Wyckoff            |
| .11       | Betatron  | Dr. Herman W. Koch               |
| .12       | Nucleonic Instrumentation                                 | Dr. Louis Costrell               |
| .13       | Radiological Equipment                                    | Dr. Scott W. Smith               |
| .14       | Radiation Instruments Branch,<br>Atomic Energy Commission | Robert L. Butenhoff              |
| <b>5</b>  | <b>CHEMISTRY</b>  | Dr. Edward W. Wichers            |
|           | Assistant Chief   | Dr. James I. Hoffman             |
| .1        | Organic Coatings  | Paul T. Howard                   |
| .2        | Surface Chemistry   | Dr. James I. Hoffman             |
| .3        | Organic Chemistry   | W. Harold Smith                  |
| .4        | Analytical Chemistry                                      | Harry A. Bright                  |
| .5        | Inorganic Chemistry                                       | Dr. Raleigh Gilchrist            |
| .6        | Electrodeposition   | Dr. Abner Brenner                |
| .7        | Gas Chemistry   | Elmer R. Weaver                  |
| .8        | Physical Chemistry  | Dr. Edgar R. Smith               |
| .9        | Thermochemistry   | Edward J. Prosen                 |
| .10       | Spectrochemistry  | Bourdon F. Scribner              |
| .11       | Pure Substances   | Dr. Charles P. Saylor            |
| <b>6</b>  | <b>MECHANICS</b>  | Dr. Walter Ramberg               |
|           | Consultant  | Dr. Wilmer Souder                |
| .1        | Sound   | Dr. Richard K. Cook              |
| .2        | Mechanical Instruments                                    | Edward C. Lloyd                  |
| .3        | Fluid Mechanics   | Dr. Galen B. Schubauer           |
| .4        | Engineering Mechanics                                     | Bruce L. Wilson                  |
| .6        | Mass and Scale  | Douglas R. Tate                  |
| .7        | Capacity, Density and Fluid Meters                        | Howard S. Bean                   |
| .8        | Combustion Controls                                       | Dr. Ernest F. Fiock              |
| <b>7</b>  | <b>ORGANIC AND FIBROUS MATERIALS</b>                      | Dr. Gordon M. Kline              |
|           | Assistant Chief   | Dr. Irl C. Schoonover            |
| .1        | Rubber  | Dr. Lawrence A. Wood             |
| .2        | Textiles  | William D. Appel                 |
| .3        | Paper   | Dr. Robert B. Hobbs              |
| .4        | Leather   | Everett L. Wallace               |
| .5        | Testing and Specifications                                | Dr. Robert D. Stiehler           |
| .6        | Polymer Structure   | Dr. Irl C. Schoonover            |
| .7        | Organic Plastics  | Frank W. Reinhart                |
| .8        | Dental Research   | William T. Sweeney               |
| <b>8</b>  | <b>METALLURGY</b>   | Dr. John G. Thompson             |
| .1        | Thermal Metallurgy  | Thomas G. Digges                 |
| .2        | Chemical Metallurgy                                       | LeRoy L. Wyman                   |
| .3        | Mechanical Metallurgy                                     | John A. Bennett                  |
| .4        | Corrosion   | George A. Ellinger               |

- 9 MINERAL PRODUCTS**  
 Consultant  
 .1 Porcelain and Pottery  
 .2 Glass  
 .3 Refractories  
 .4 Enameled Metals  
 .6 Concreting Materials  
 .7 Constitution and Microstructure
- Clarence H. Hahner (Acting)  
 Dr. Lansing S. Wells  
 Roman F. Geller  
 Clarence H. Hahner  
 Raymond A. Heindl  
 William N. Harrison  
 Raymond L. Blaine  
 Howard F. McMurdie
- 10 BUILDING TECHNOLOGY**  
 Assistant Chief  
 Consultant  
 Consultant  
 .1 Structural Engineering  
 .2 Fire Protection  
 .3 Heating and Air Conditioning  
 .4 Floor, Roof and Wall Coverings  
 .5 Codes and Specifications
- Douglas E. Parsons  
 George N. Thompson  
 William F. Roeser  
 John W. McBurney  
 Douglas E. Parsons  
 Dr. Alexander F. Robertson  
 Richard S. Dill  
 Dr. Hubert R. Snoke  
 George N. Thompson
- 11 APPLIED MATHEMATICS**  
 Assistant Chief  
 \* .1 Numerical Analysis  
 .2 Computation  
 .3 Statistical Engineering  
 .4 Machine Development
- Dr. Franz L. Alt (Acting)  
 Dr. Edward W. Cannon  
 Dr. C. B. Tompkins (Acting) UCLA  
 John Todd  
 Dr. Churchill Eisenhart  
 Dr. Edward W. Cannon
- 12 ELECTRONICS**  
 .1 Engineering Electronics  
 .2 Electron Tubes  
 .3 Electronic Computers  
 .4 Electronic Instrumentation  
 .5 Process Technology
- Dr. Robert D. Huntoon (Acting)  
 Dr. Paul J. Selgin  
 Dr. Charles P. Marsden, Jr. (Acting)  
 Dr. Samuel N. Alexander  
 Carroll Stansbury  
 Lucien P. Tuckerman (Acting)
- 14 CENTRAL RADIO PROPAGATION LABORATORY**  
 Assistant Chief  
 Consultant  
 Consultant  
 .3 Regular Propagation Services  
**Ionospheric Research Laboratory**  
 .1 Upper Atmosphere Research  
 .5 Ionospheric Research  
**Systems Research Laboratory**  
 \* .4 Frequency Utilization Research  
 \* .6 Tropospheric Propagation (Res.)  
**Measurement Standards Laboratory**  
 .8 High Frequency Standards  
 .9 Microwave Standards
- Dr. Robert D. Huntoon (Acting)  
 Dr. Ralph J. Slutz  
 Alvin G. McNish  
 Dana K. Bailey  
 Walter B. Chadwick
- Thomas N. Gautier (Acting)  
 Ross Bateman
- Kenneth A. Norton (Boulder)  
 Jack W. Herbstreit (Boulder)
- William D. George  
 Dr. Harold Lyons
- 40 ACCOUNTING**  
 Deputy Chief  
 .1 Accounting Operations  
 .2 Internal Audit
- Gordon D. Horsburgh  
 Willard K. Duckworth  
 Willard K. Duckworth  
 Robert A. Strizzi

<b>41</b>	<b>PERSONNEL</b>	
	Assistant Chief	George R. Porter
.1	Board of Civil Service Examiners	Frankie R. Keyser
.2	Recruitment and Placement	Edith N. Fimple
.3	Classification	Frankie R. Keyser
.4	Employee Relations	Charles V. Ramey
.5	Operations and Procedures	Ruth B. Armsby
.6	Medical Office	Helen V. Courtney
		Dr. Charles P. Waite
<b>42</b>	<b>ADMINISTRATIVE SERVICES</b>	
	Assistant Chief	Harry P. Dalzell
.1	Records and Communications	Karl L. Hafen
.2	Special Services	Robert W. Lamberson
.3	Janitorial Services	Gird M. Tolley, Jr. (Acting)
.4	Guard Services	Robert C. Howey
.5	Transportation Services, Garage	Vacant
.6	Deputy Security Officer	Charles W. Anderson
.7	Test Administration	Harry P. Dalzell
		Randolph K. Artz
<b>43</b>	<b>SHOPS</b>	
	Assistant Chief	Frank P. Brown
.1	Instrument Shop No. 1	Winfield L. Drissel
.2	Instrument Shop No. 2	David G. Kennedy
.3	Instrument Shop No. 3	George A. Rheinbold
.4	Instrument Shop No. 4	George A. Rheinbold
.5	Instrument Shop No. 5	Norman C. Pines
.6	Instrument Shop No. 6	Robert E. Ward
.7	Welding and Sheet Metal Shop	Andrew J. Altman
.8	Ordnance Development Branch Shop	Terrell C. Freemon
.9	Tool Crib	August C. Kus
.10	Maintenance	Lewis H. Brigham
.11	Glassblowing Shop	Winfield L. Drissel
		Leonardo Testa
<b>44</b>	<b>SUPPLY</b>	
.3	Procurement	Charles B. Kipps (Acting)
.4	Property Management	Charles B. Kipps
		Harold G. Nicholas (Acting)
<b>45</b>	<b>MANAGEMENT PLANNING STAFF</b>	Ivan Asay
<b>46</b>	<b>BUDGET STAFF</b>	Wilbur W. Bolton, Jr.
<b>50</b>	<b>PLANT</b>	
	Assistant Chief	Charles A. Dieman
.1	Power Plant	Clarence B. Crane
.2	Electric Shop	Arthur C. Ramm
.3	Piping Shop	George V. Hall
.4	Construction Shop	Raymond A. Watson
.5	Paint Shop	John A. King
.6	Labor Services	Howell C. Walker
.7	Metal Shop	Roy B. Powell
.9	Grounds	Charles Needham
.11	Refrigeration and Air Conditioning	William R. David
		James S. Powers (Acting)

\* Laboratories located in Boulder, Colorado, and Los Angeles, California.



**FIELD STATIONS**

- 2 OPTICS AND METROLOGY**  
Lamp Inspector, Brookline, MA  
Visual Landing Aids Field Laboratory, Arcata Airport, Arcata, Humboldt County, CA
- 3 HEAT AND POWER**  
**3.6 Cryogenic Engineering, Boulder, CO**
- 6 MECHANICS DIVISION**  
NBS Master Railway Track Scale Depot, Clearing, IL  
**6.4 Engineering Mechanics, Boulder, CO**
- 9 MINERAL PRODUCTS**  
**9.06 Concreting Materials**  
Allentown, PA  
Denver, CO  
Kansas City, MO  
San Francisco, CA  
Seattle, WA
- 11 APPLIED MATHEMATICS**  
**11.01 Numerical Analysis, The Institute for Numerical Analysis, University of California at Los Angeles**  
Director of Research C. B. Tompkins (Acting)  
Assistant Director Dr. Magnus R. Hestenes  
Assistant Director Dr. Harry D. Huskey
- 14 CENTRAL RADIO PROPAGATION LABORATORY**  
Radio Propagation Field Station, Anchorage, AK  
Radio Propagation Field Station, Point Barrow, AK  
Radio Propagation Field Station, Guam Island  
Radio Propagation Field Station, Puunene, Maui, Territory of Hawaii  
Radio Propagation Field Station, Ramey Air Force Base, Puerto Rico  
Radio Propagation Field Station, Blue West-1, Greenland  
Radio Propagation Field Station, Fort Gulick, Panama Canal Zone  
Cheyenne Mountain Field Station, Colorado Springs, CO  
Radio Field Station, Ft. Belvoir, VA  
Radio Propagation Laboratory, Sterling, VA  
Radio Transmitting Station, Beltsville, MD  
National Bureau of Standards, Boulder CO
- 80 FACILITIES**  
Boulder, CO

**JANUARY 1956**

- 30 DIRECTOR'S OFFICE**  
Director  
Assistant to the Director  
Assistant to the Director  
Associate Director for Chemistry  
Consultant to the Director  
Associate Director for Physics  
Associate Director for Testing  
Associate Director for Planning  
\* Director, Boulder Laboratories  
Assistant Director for Administration  
Consultant to the Director  
Consultant to the Director  
Consultant to the Director  
Consultant to the Director  
Director Emeritus
- Dr. Allen V. Astin  
Dr. Henry Birnbaum  
Clarence N. Coates  
Dr. Wallace R. Brode  
Dr. Wilmer Souder  
Dr. Robert D. Huntoon  
Dr. Archibald T. McPherson  
Nicholas E. Golovin  
Dr. Frederick W. Brown (Boulder)  
Robert S. Walleigh  
Dr. Eugene C. Crittenden  
Dr. Leon F. Curtiss  
Dr. Chester H. Page  
Alvin G. McNish  
Dr. Lyman J. Briggs
- 31 OFFICE OF PUBLICATIONS**  
.1 Library  
.2 Editorial and Printing
- Dr. Wallace R. Brode  
Sarah Ann Jones  
Jesse L. Mathusa
- 32 OFFICE OF WEIGHTS AND MEASURES**  
Assistant Chief  
Consultant
- William S. Bussey  
Malcolm W. Jensen  
Ralph W. Smith
- 33 OFFICE OF BASIC INSTRUMENTATION**  
Assistant to the Chief
- William A. Wildhack
- 34 OFFICE OF TECHNICAL PUBLICATIONS**  
.4 Photographic Services
- W. Reeves Tilley  
Warren P. Richardson
- 1 ELECTRICITY AND ELECTRONICS**  
Assistant Chief for Electronics  
.1 Resistance and Reactance  
.2 Electron Tubes  
.3 Electrical Instruments  
.4 Magnetic Measurements  
.5 Process Technology  
.6 Engineering Electronics  
.7 Electronic Instrumentation  
.8 Electrochemistry
- Dr. Francis B. Silsbee  
Carroll Stansbury  
Dr. James L. Thomas  
Charles P. Marsden, Jr.  
Dr. Francis M. Defandorf  
Irvin L. Cooter (Acting)  
Lucien P. Tuckerman  
G. Shapiro (Acting)  
Carroll Stansbury  
Dr. Walter J. Hamer
- 2 OPTICS AND METROLOGY**  
Assistant to the Chief  
.1 Photometry and Colorimetry  
.2 Optical Instruments  
.3 Photographic Technology  
.4 Length  
.5 Engineering Metrology
- Dr. Irvine C. Gardner  
Leroy W. Tilton  
Louis E. Barbrow  
Dr. Francis E. Washer  
Raymond Davis  
Dr. Lewis V. Judson  
Irvin H. Fullmer

- 3 HEAT AND POWER**  
 .1 Temperature Measurements  
 .2 Thermodynamics  
 .3 Cryogenic Physics  
 .4 Engines and Lubrication  
 .5 Engine Fuels
- 4 ATOMIC AND RADIATION PHYSICS**  
**Atomic Physics Laboratory**  
 .1 Spectroscopy  
 .2 Radiometry  
 .3 Mass Spectrometry  
 .4 Solid State Physics  
 .5 Electron Physics  
 .6 Atomic Physics  
**Radiation Physics Laboratory**  
 .8 Nuclear Physics  
 .9 Radioactivity  
 .10 X-Rays  
 .11 Betatron  
 .12 Nucleonic Instrumentation  
 .13 Radiological Equipment  
 .14 Radiation Instruments Branch,  
 Atomic Energy Commission
- 5 CHEMISTRY**  
 Assistant Chief  
 .1 Organic Coatings  
 .2 Surface Chemistry  
 .3 Organic Chemistry  
 .4 Analytical Chemistry  
 .5 Inorganic Chemistry  
 .6 Electrodeposition  
 .7 Gas Chemistry  
 .8 Physical Chemistry  
 .9 Thermochemistry  
 .10 Spectrochemistry  
 .11 Pure Substances
- 6 MECHANICS**  
 Consultant  
 Consultant  
 .1 Sound  
 .2 Mechanical Instruments  
 .3 Fluid Mechanics  
 .4 Engineering Mechanics  
 .6 Mass and Scale  
 .7 Capacity, Density and Fluid Meters  
 .8 Combustion Controls
- Dr. Ferdinand G. Brickwedde  
 James F. Swindells  
 Dr. Charles W. Beckett  
 Dr. Ralph P. Hudson  
 Pei Moo Ku (Acting)  
 Dr. Frank L. Howard
- Dr. Lauriston S. Taylor
- Dr. William F. Meggers  
 Dr. Earle K. Plyler  
 Dr. Fred L. Mohler  
 Dr. Earle K. Plyler (Acting)  
 Dr. Ladislaus L. Marton  
 Dr. Lewis M. Branscomb  
 Dr. Harold O. Wyckoff  
 Dr. Ugo Fano  
 Dr. Wilfrid B. Mann  
 Dr. Harold O. Wyckoff  
 Dr. Herman W. Koch  
 Dr. Louis Costrell  
 Dr. Scott W. Smith
- Robert L. Butenhoff
- Dr. Edward W. Wichers  
 Dr. James I. Hoffman  
 Paul T. Howard  
 Dr. James I. Hoffman  
 W. Harold Smith  
 Harry A. Bright  
 Dr. Raleigh Gilchrist  
 Dr. Abner Brenner  
 Elmer R. Weaver  
 Dr. Edgar R. Smith  
 Edward J. Prosen  
 Bourdon F. Scribner  
 Dr. Charles P. Saylor
- Dr. Walter Ramberg  
 Dr. William G. Brombacher  
 Dr. Louis B. Tuckerman  
 Dr. Richard K. Cook  
 Edward C. Lloyd  
 Dr. Galen B. Schubauer  
 Bruce L. Wilson  
 Douglas R. Tate  
 Howard S. Bean  
 Dr. Ernest F. Fiock

- 7 ORGANIC AND FIBROUS MATERIALS**  
Assistant Chief
- .1 Rubber
  - .2 Textiles
  - .3 Paper
  - .4 Leather
  - .5 Testing and Specifications
  - .6 Polymer Structure
  - .7 Plastics
  - .8 Dental Research
- Dr. Gordon M. Kline  
William D. Appel  
Dr. Lawrence A. Wood  
William D. Appel  
Dr. Robert B. Hobbs  
Dr. Joseph R. Kanagy  
Dr. Robert D. Stiehler  
Dr. Norman P. Bekkedahl  
Frank W. Reinhart  
William T. Sweeney
- 8 METALLURGY**
- .1 Thermal Metallurgy
  - .2 Chemical Metallurgy
  - .3 Mechanical Metallurgy
  - .4 Corrosion
- Dr. John G. Thompson  
Thomas G. Digges  
LeRoy L. Wyman  
John A. Bennett  
George A. Ellinger
- 9 MINERAL PRODUCTS**  
Assistant Chief
- .1 Porcelain and Pottery
  - .2 Glass
  - .3 Refractories
  - .4 Enameled Metals
  - .6 Concreting Materials
  - .7 Constitution and Microstructure
- Dr. Irl C. Schoonover  
Clarence H. Hahner  
Milton D. Burdick (Acting)  
Clarence H. Hahner  
Dr. Samuel Zerfoss  
William N. Harrison  
Raymond L. Blaine  
Howard F. McMurdie
- 10 BUILDING TECHNOLOGY**  
Assistant Chief  
Consultant  
Consultant
- .1 Structural Engineering
  - .2 Fire Protection
  - .3 Heating and Air Conditioning
  - .4 Floor, Roof and Wall Coverings
  - .5 Codes and Specifications
- Douglas E. Parsons  
Dr. Hubert R. Snoke  
William F. Roeser  
Dr. John W. McBurney  
D. Watstein (Acting)  
Dr. Alexander F. Robertson  
Richard S. Dill  
Dr. Hubert R. Snoke  
John A. Dickinson
- 11 APPLIED MATHEMATICS**  
Assistant Chief
- .1 Numerical Analysis
  - .2 Computation
  - .3 Statistical Engineering
  - .4 Mathematical Physics
- Dr. Edward W. Cannon  
Dr. Franz L. Alt  
John Todd  
Dr. M. Abramowitz  
Dr. Churchill Eisenhart  
Dr. Robert F. Dressler
- 12 DATA PROCESSING SYSTEMS**  
Assistant Chief for Systems
- .1 Components and Techniques
  - .2 Digital Circuitry
  - .3 Digital Systems
  - .4 Analog Systems
  - .5 Application Engineering
- Samuel N. Alexander  
Dr. Harold K. Skramstad  
Robert D. Elbourn  
Sidney Greenwald (Acting)  
Alan L. Leiner  
Dr. Harold K. Skramstad  
Samuel N. Alexander (Acting)

- 40 ACCOUNTING**  
Deputy Chief
- .1 Accounts and Reports
  - .2 Classification
  - .3 Tabulation
  - .4 Voucher Examination
  - .5 Billing and Collection
  - .6 Payroll
  - .7 Internal Audit
- 41 PERSONNEL**
- .1 Board of Civil Service Examiners
  - .2 Recruitment and Placement
  - .3 Classification
  - .4 Employee Relations
  - .5 Operations and Procedures
  - .6 Medical Office
- 42 ADMINISTRATIVE SERVICES**  
Assistant Chief
- .1 Records and Communications
  - .2 Special Services
  - .3 Janitorial Services
  - .4 Guard Services
  - .5 Transportation Services
  - .6 Security Office
  - .7 Test Administration
- 43 SHOPS**  
Assistant Chief
- .1 Instrument Shop No. 1
  - .2 Instrument Shop No. 2
  - .3 Instrument Shop No. 3
  - .4 Instrument Shop No. 4
  - .5 Instrument Shop No. 5
  - .7 Welding and Sheet Metal Shop
  - .9 Tool Crib
  - .11 Glassblowing Shop
- 44 SUPPLY**  
Deputy Chief
- .3 Procurement
  - .4 Property Management
- 45 MANAGEMENT PLANNING**  
Assistant Chief
- 46 BUDGET STAFF**  
Deputy Budget Officer
- Paul R. McClenon  
Horace E. Hardaway  
Robert A. Strizzi  
Pearl E. Miller  
John P. Lafon  
Matilda Udoff  
Doris J. Lothrop  
Kathryn L. Rock  
James P. Menzer
- George R. Porter  
Edith N. Fimple  
Frankie R. Keyser  
Charles V. Ramey  
Ruth B. Armsby  
Helen V. Courtney  
Dr. Glen Pincock
- Harry P. Dalzell  
Karl L. Hafen  
Vacant  
Gird M. Tolley, Jr.  
Robert C. Howey  
Capt. William R. Allen  
Charles W. Anderson  
Harry P. Dalzell  
Randolph K. Artz
- Frank P. Brown  
Winfield L. Drissel  
David G. Kennedy  
George A. Rheinbold  
George A. Rheinbold  
Norman C. Pines  
Carl E. Pelander  
Terrell C. Freeman  
Lewis H. Brigham  
Leonardo Testa
- George B. Kefover  
Norman L. Christeller  
Charles B. Kipps  
Fred H. Johncox
- Ivan Asay  
George E. Auman
- Wilbur W. Bolton, Jr.  
William E. Lilly

<b>50</b>	<b>PLANT</b>	
	Assistant Chief	Charles A. Dieman
.1	Power Plant	Clarence B. Crane
.2	Electric Shop	Arthur C. Ramm
.3	Piping Shop	George V. Hall
.4	Construction Shop	Raymond A. Watson
.5	Paint Shop	John A. King
.6	Labor Services	Howell C. Walker
.7	Metal Shop	Roy B. Powell
.8	Special Laboratory Service	Charles Needham
.9	Grounds	Donald J. Leweck (Acting)
.11	Refrigeration and Air Conditioning	William R. Stevenson
		James S. Powers
<b>*80</b>	<b>BOULDER LABORATORIES</b>	
	<b>DIRECTOR'S OFFICE</b>	
	Director	Dr. Frederick W. Brown
.1	Executive Officer	Samuel W. J. Welch
.3	Statistician	Dr. Edwin L. Crow
.4	Information Officer	Charles L. Bragaw
.5	Library	Victoria S. Barker
	<b>ADMINISTRATIVE DIVISION</b>	Samuel W. J. Welch
.2	Fiscal Office	Herbert D. Stansell
.3	Personnel	Roy W. Stockwell, Jr.
.4	General Services Section	Barton F. Betts
.5	Engineering Services Section	Paul S. Ballif
<b>81</b>	<b>CRYOGENIC ENGINEERING</b>	
.1	Cryogenic Equipment	Russell B. Scott
.2	Cryogenic Processes	Bascom W. Birmingham
.3	Properties of Materials	Peter C. Vander Arend
.4	Gas Liquefaction	Dr. R. Joseph Corruccini
		Victor J. Johnson
<b>84</b>	<b>RADIO STANDARDS</b>	
<b>84A</b>	<b>High Frequency Standards Branch</b>	Dr. Harold A. Thomas
.1	High Frequency Electrical Standards	William D. George
.2	Radio Broadcast Service	Myron C. Selby
.3	HF Impedance Standard	Alvin H. Morgan
		William D. George (Acting)
<b>84B</b>	<b>Microwave Standards Branch</b>	Vacant
.6	Extreme High-Frequency and Noise	David M. Kerns
.7	Microwave Frequency and Spectroscopy	George Bimbaum
.8	Microwave Circuit Standards	Robert W. Beatty (Acting)
	<b>CENTRAL RADIO PROPAGATION LABORATORY</b>	
<b>82</b>	<b>RADIO PROPAGATION PHYSICS</b>	
	Consultant	Dr. Ralph J. Slutz
	Consultant	Dr. Franklin E. Roach
		Dana K. Bailey
		Thomas N. Gautier
<b>**</b>	.1 Upper Atmosphere Research	Richard C. Kirby (Acting) (Washington)
	.2 Ionospheric Research	Walter B. Chadwick
	.3 Regular Propagation Services	Richard C. Kirby
	.5 Ionospheric Research (Boulder)	

- 83 RADIO PROPAGATION ENGINEERING**  
Consultant  
.4 Frequency Utilization Research  
.6 Tropospheric Propagation Research

Kenneth A. Norton  
Dr. James R. Wait  
William Q. Crichlow  
Jack W. Herbstreit

\* Laboratories located in Boulder, Colorado.

\*\* Laboratory located in Washington, D.C.

#### FIELD STATIONS

- 2 OPTICS AND METROLOGY**  
Lamp Inspector, Brookline, MA  
Visual Landing Aids Field Laboratory, Arcata Airport, Arcata, CA
- 6 MECHANICS**  
NBS Master Railway Track Scale Depot, Clearing, IL
- 9 MINERAL PRODUCTS**  
**9.6 Concreting Materials**  
Allentown, PA  
Denver, CO  
San Francisco, CA  
Seattle, WA
- 80 Boulder Laboratories**  
Boulder Laboratories, National Bureau of Standards, Boulder, CO  
Radio Propagation Field Station, Anchorage, AK  
Radio Propagation Field Station, Point Barrow, AK  
Radio Propagation Field Station, Guam Island  
Radio Propagation Field Station, Puunene, Maui, Territory of Hawaii  
Radio Propagation Field Station, Ramey Air Force Base, Puerto Rico  
Radio Propagation Field Station, Bluie West-1, Greenland  
Radio Propagation Field Station, Fort Gulick, Panama Canal Zone  
Radio Propagation Field Station, Carthage, IL  
Cheyenne Mountain Field Station, Colorado Springs, CO  
Radio Propagation Field Station, Ft. Belvoir, VA  
Radio Propagation Laboratory, Sterling, VA  
Radio Transmitting Station, Beltsville, MD  
Radio Noise Recording Station, Front Royal, VA

## FEBRUARY 1959

- 30 DIRECTOR'S OFFICE**  
Deputy Director  
Library  
Associate Director for Physics  
Associate Director for Engineering  
Associate Director for Chemistry  
Associate Director for Planning  
Associate Director for Administration  
\* Associate Director for the Boulder Laboratories  
Consultant to the Director  
Consultant to the Director  
Consultant to the Director  
Director Emeritus
- 32 OFFICE OF WEIGHTS AND MEASURES**
- 33 OFFICE OF BASIC INSTRUMENTATION**
- 34 OFFICE OF TECHNICAL INFORMATION**  
.1 Information  
.2 Editorial  
.3 Publications  
.4 Photographic Services
- 1 ELECTRICITY AND ELECTRONICS**  
.1 Resistance and Reactance  
.2 Electron Devices  
.3 Electrical Instruments  
.4 Magnetic Measurements  
.5 Dielectrics  
.6 Engineering Electronics  
.7 Electronic Instrumentation  
.8 Electrochemistry
- 2 OPTICS AND METROLOGY**  
.1 Photometry and Colorimetry  
.2 Optical Instruments  
.3 Photographic Technology  
.4 Length  
.5 Engineering Metrology
- 3 HEAT**  
.1 Temperature Physics  
.2 Thermodynamics  
.3 Cryogenic Physics  
.4 Rheology  
.5 Engine Fuels  
.6 Free Radicals Research
- Dr. Allen V. Astin  
Dr. Robert D. Huntoon  
Sarah Ann Jones  
Dr. Robert D. Huntoon  
Dr. Archibald T. McPherson  
Dr. Edward W. Wichers  
Dr. Irl C. Schoonover  
Robert S. Walleigh  
Dr. Frederick W. Brown  
Dr. Ferdinand G. Brickwedde  
Dr. Leon F. Curtiss  
Alvin G. McNish  
Dr. Chester H. Page  
Dr. Lyman J. Briggs
- William S. Bussey
- William A. Wildhack
- W. Reeves Tilley  
Paul E. Walsh (Acting)  
William K. Gautier  
John E. Carpenter  
Warren P. Richardson
- Dr. Francis B. Silsbee  
Dr. James L. Thomas  
Charles P. Marsden  
Dr. Francis M. Defandorf  
Irvin L. Cooter  
Dr. John D. Hoffman  
Gustave Shapiro  
G. Franklin Montgomery  
Dr. Walter J. Hamer
- Dr. Irvine C. Gardner  
Louis E. Barbrow  
Dr. Francis E. Washer  
Calvin S. McCamy  
Dr. Lewis V. Judson  
Irvin H. Fullmer
- Dr. Charles M. Herzfeld  
James F. Swindells  
Dr. Charles W. Beckett  
Dr. Ralph P. Hudson  
Dr. Robert S. Marvin  
Dr. Frank L. Howard  
Dr. Herbert P. Broida



- 4 ATOMIC AND RADIATION PHYSICS**  
**Atomic Physics Laboratory**  
.1 Spectroscopy  
.2 Radiometry  
.3 Mass Spectrometry  
.4 Solid State Physics  
.5 Electron Physics  
.6 Atomic Physics  
**Radiation Physics Laboratory**  
.7 Neutron Physics  
.8 Radiation Theory  
.9 Radioactivity  
.10 X-Rays  
.11 High Energy Radiation  
.12 Nucleonic Instrumentation  
.13 Radiological Equipment
- 5 CHEMISTRY**  
.1 Organic Coatings  
.2 Surface Chemistry  
.3 Organic Chemistry  
.4 Analytical Chemistry  
.5 Inorganic Chemistry  
.6 Electrodeposition  
.7 Molecular Structure and Properties of Gases  
.8 Physical Chemistry  
.9 Thermochemistry  
.10 Spectrochemistry  
.11 Pure Substances
- 6 MECHANICS**  
.1 Sound  
.2 Mechanical Instruments  
.3 Fluid Mechanics  
.4 Engineering Mechanics  
.6 Mass and Scale  
.7 Capacity, Density and Fluid Meters  
.8 Combustion Controls
- 7 ORGANIC AND FIBROUS MATERIALS**  
.1 Rubber  
.2 Textiles  
.3 Paper  
.4 Leather  
.5 Testing and Specifications  
.6 Polymer Structure  
.7 Plastics  
.8 Dental Research
- 8 METALLURGY**  
.1 Thermal Metallurgy  
.2 Chemical Metallurgy  
.3 Mechanical Metallurgy  
.4 Corrosion  
.5 Metal Physics
- Lauriston S. Taylor  
Bourdon F. Scribner (Acting)  
Dr. Earle K. Plyler  
Dr. Fred L. Mohler  
Dr. Hans P. R. Frederikse  
Dr. Ladislaus L. Marton  
Dr. Lewis M. Branscomb  
Dr. Harold O. Wyckoff  
Dr. Randall S. Caswell  
Dr. Ugo Fano  
Dr. Wilfrid B. Mann  
Dr. Harold O. Wyckoff  
Dr. Herman W. Koch  
Louis Costrell  
Dr. Scott W. Smith
- Dr. Edward W. Wichers (Acting)  
Paul T. Howard  
Dr. William W. Walton  
Dr. Horace S. Isbell  
Harry A. Bright  
Dr. Raleigh Gilchrist  
Dr. Abner Brenner  
Floyd Buckley  
Dr. Roger G. Bates  
Edward J. Prosen  
Bourdon F. Scribner  
Dr. Charles P. Saylor
- Dr. Walter Ramberg  
Dr. Richard K. Cook  
Edward C. Lloyd  
Dr. Galen B. Schubauer  
Bruce L. Wilson  
H. Steffen Peiser  
Charles T. Collett (Acting)  
Frank R. Caldwell
- Dr. Gordon M. Kline  
Dr. Lawrence A. Wood  
Dr. Herbert F. Schiefer  
Dr. Robert B. Hobbs  
Dr. Joseph R. Kanagy  
Dr. Robert D. Stiehler  
Dr. Norman P. Bekkedahl  
Dr. Frank W. Reinhart  
William T. Sweeney
- Dr. James I. Hoffman  
Thomas G. Digges  
LeRoy L. Wyman  
John A. Bennett  
George A. Ellinger  
Dr. Lawrence M. Kushner

<b>9</b>	<b>MINERAL PRODUCTS</b>	
	.1 Engineering Ceramics	Dr. Irl C. Schoonover (Acting)
	.2 Glass	Milton D. Burdick
	.3 Refractories	Clarence H. Hahner
	.4 Enameled Metals	Vacant
	.6 Concreting Materials	William N. Harrison
	.7 Constitution and Microstructure	Raymond L. Blaine Howard F. McMurdie
<b>10</b>	<b>BUILDING TECHNOLOGY</b>	
	.1 Structural Engineering	Douglas E. Parsons
	.2 Fire Protection	David Watstein
	.3 Air Conditioning, Heating, and Refrigeration	Dr. Alexander F. Robertson
	.4 Floor, Roof and Wall Coverings	Paul R. Achenbach
	.5 Codes and Safety Standards	Dr. Hubert R. Snoke
	.6 Heat Transfer	John A. Dickinson Henry E. Robinson
<b>11</b>	<b>APPLIED MATHEMATICS</b>	
	.1 Numerical Analysis	Dr. Edward W. Cannon
	.2 Computation	Dr. Philip J. Davis
	.3 Statistical Engineering	Dr. Edward W. Cannon (Acting)
	.4 Mathematical Physics	Dr. Churchill Eisenhart Dr. Robert F. Dressler
<b>12</b>	<b>DATA PROCESSING SYSTEMS</b>	
	.1 Components and Techniques	Samuel N. Alexander
	.2 Digital Circuitry	Robert D. Elbourn
	.3 Digital Systems	Sidney Greenwald
	.4 Analog Systems	Alan L. Leiner
	.5 Applications Engineering	Dr. Harold K. Skramstad Samuel N. Alexander (Acting)
<b>40</b>	<b>ACCOUNTING</b>	
	.1 Reports and Billing	Horace E. Hardaway
	.2 Classification	Mrs. Pearl E. Miller
	.3 Tabulation	Robert J. Goldsmith
	.4 Voucher Examination	Walter G. Shackelford
	.6 Payroll	Matilda Udoff Kathryn L. Rock
<b>41</b>	<b>PERSONNEL</b>	
	.2 Recruitment and Placement	George R. Porter
	.3 Salary and Wage Administration	Frankie R. Keyser
	.4 Employee Relations and Training	Charles V. Ramey
	.5 Operations and Procedures	Ruth B. Armsby
	.6 Medical Office	Helen V. Courtney Dr. Glen Pincock
<b>42</b>	<b>ADMINISTRATIVE SERVICES</b>	
	.1 Records and Communications	Harry P. Dalzell
	.2 Special Services	Howard L. Sampson
	.3 Janitorial Services	Raymond S. Cudmore (Acting)
	.4 Guard Services	Robert C. Howey
	.5 Transportation Services	Capt. William R. Allen
	.6 Security Office	Charles W. Anderson
	.7 Test Administration	Harry P. Dalzell Randolph K. Artz

<b>43</b>	<b>SHOPS</b>	Frank P. Brown
	.1 Instrument Shop #1	Carl E. Pelander
	.2 Instrument Shop #2	George A. Rheinbold
	.3 Instrument Shop #3	George A. Rheinbold
	.4 Instrument Shop #4	Norman C. Pines
	.5 Instrument Shop #5	John L. Pararas
	.7 Welding and Sheet Metal Shop	Terrell C. Freemon
	.9 Tool Crib	Lewis H. Brigham
	.11 Glassblowing Shop	Leonardo Testa
<b>44</b>	<b>SUPPLY</b>	George B. Kefover
	.3 Procurement	Charles B. Kipps
	.4 Property Management	Fred H. Johncox
<b>45</b>	<b>MANAGEMENT PLANNING</b>	Ivan Asay
<b>46</b>	<b>BUDGET</b>	Norman L. Christeller
<b>47</b>	<b>INTERNAL AUDIT</b>	James P. Menzer
<b>50</b>	<b>PLANT</b>	Hylton Graham
	.1 Heating and Air Conditioning	James S. Powers
	.2 Electric Shop	George V. Hall
	.3 Piping	Raymond A. Watson
	.4 Construction Shop	John A. King
	.5 Paint Shop	Howell C. Walker
	.6 Labor Services	Roy B. Powell
	.7 Metal Shop	Donald I. Thompson
	.9 Grounds	William R. Stevenson
 <b>*BOULDER LABORATORIES</b>		
<b>79</b>	<b>DIRECTOR'S OFFICE</b>	Dr. Frederick W. Brown
	Associate Director, NBS	Samuel W. J. Welch
	Executive Officer	Dr. Richard N. Thomas
	Consultant	Dr. James R. Wait
	Consultant	
<b>80</b>	<b>ADMINISTRATIVE</b>	Samuel W. J. Welch
	.1 Management Planning	Jessie B. Berkley
	.2 Fiscal Office	Herbert D. Stansell
	.3 Personnel	Roy W. Stockwell, Jr.
	.4 General Services (Supply Officer)	Barton F. Betts
	.5 Engineering Services	Paul S. Ballif
<b>81</b>	<b>CRYOGENIC ENGINEERING LABORATORY</b>	Russell B. Scott
	.1 Cryogenic Equipment	Dr. Robert B. Jacobs
	.2 Cryogenic Processes	Bascom W. Birmingham
	.3 Properties of Materials	Dr. R. Joseph Corruccini
	.4 Gas Liquefaction	Victor J. Johnson

- |           |   |                                 |
|-----------|---|---------------------------------|
| <b>84</b> | <b>RADIO STANDARDS LABORATORY</b>                     | William D. George (Acting)      |
|           | .1 High Frequency Electrical Standards                | Myron C. Selby                  |
|           | .2 Radio Broadcast Service                            | Alvin H. Morgan                 |
|           | .3 High Frequency Impedance Standards                 | John L. Dalke                   |
|           | .5 Electronic Calibration Center                      | Harvey W. Lance                 |
|           | .7 Microwave Physics                                  | Dr. John M. Richardson          |
|           | .8 Microwave Circuit Standards                        | Robert W. Beatty                |
|           | <b>CENTRAL RADIO PROPAGATION LABORATORY</b>           | Dr. Frederick W. Brown (Acting) |
| <b>82</b> | <b>RADIO PROPAGATION PHYSICS</b>                      | Dr. Ralph J. Slutz              |
|           | .1 Upper Atmosphere Research                          | Roger M. Gallet                 |
|           | .2 Ionospheric Research                               | Dr. Ernest K. Smith, Jr.        |
|           | .3 Regular Prediction Services                        | Walter B. Chadwick              |
|           | .4 Sun Earth Relationships                            | Robert W. Knecht                |
|           | .5 VHF Research                                       | Dr. Kenneth L. Bowles (Acting)  |
|           | .6 Radio Warning Services                             | J. Virginia Lincoln             |
|           | .7 Airglow and Aurora                                 | Dr. Franklin E. Roach           |
|           | .8 Radio Astronomy and Arctic Propagation             | Dr. C. Gordon Little            |
| <b>83</b> | <b>RADIO PROPAGATION ENGINEERING</b>                  | Kenneth A. Norton               |
|           | .1 Data Reduction Instrumentation                     | Walter E. Johnson               |
|           | .2 Modulation Systems                                 | Arthur D. Watt                  |
|           | .4 Radio Noise  | William Q. Crichlow             |
|           | .5 Tropospheric Measurements                          | Charles F. Peterson             |
|           | .6 Tropospheric Analysis                              | Philip L. Rice                  |
|           | .7 Radio Systems Application Engineering              | Robert S. Kirby                 |
|           | .8 Radio Meteorology                                  | Bradford R. Bean                |
|           | .9 Lower Atmosphere Physics                           | Dr. Moody C. Thompson, Jr.      |
| <b>85</b> | <b>RADIO COMMUNICATIONS AND SYSTEMS</b>               | Richard C. Kirby                |
|           | .1 Low Frequency-Very Low Frequency Research          | A. Glenn Jean, Jr.              |
|           | .2 High Frequency-Very High Frequency Research        | Richard Silberstein             |
|           | .3 Ultra High Frequency-Super High Frequency Research | Vacant                          |
|           | .4 Modulation Research                                | J. Wesley Koch                  |
|           | .5 Antenna Research                                   | Herman V. Cottony               |
|           | .6 Navigation Systems                                 | Gifford Hefley                  |
|           | .7 Systems Analysis                                   | Donald W. Patterson (Acting)    |
|           | .8 Field Operations                                   | Harry G. Sellery                |

\* Laboratories located in Boulder, Colorado.

#### FIELD STATIONS

- |          |  |
|----------|--|
| <b>2</b> | <b>OPTICS AND METROLOGY</b>                      |
|          | Lamp Inspector, Brookline, MA                    |
|          | Visual Landing Aids Field Laboratory, Arcata, CA |
| <b>6</b> | <b>MECHANICS</b>                                 |
|          | Master Railway Track Scale Depot, Clearing, IL   |

**9 MINERAL PRODUCTS**

Concreting Materials Section  
Allentown, PA  
Denver, CO  
San Francisco, CA  
Seattle WA

**82 RADIO PROPAGATION PHYSICS**

Radio Propagation Field Station  
Anchorage, AK  
Fort Belvoir, VA  
Barrow, AK  
Ramey AFB, San Juan, Puerto Rico  
Sterling, VA  
Radio Transmitting Field Station WWVH  
Puene, Maui, HA  
Long Branch Radio Propagation Field Station  
Kilbourne, IL

**83 RADIO PROPAGATION ENGINEERING**

Cheyenne Mountain Field Station, Colorado Springs, CO  
Radio Noise Recording Station  
Front Royal, VA  
Kauai, Hawaii  
Bill, WY

**84 RADIO STANDARDS LABORATORY**

Radio Transmitting Station WWV, Beltsville, MD

MAY 1961

- 30 DIRECTOR'S OFFICE**  
Deputy Director  
Associate Director  
Associate Director  
Library  
Associate Director  
NBS Reactor Program  
Associate Director  
Associate Director  
Special Assistant to the Director  
\* Director, Boulder Laboratories  
Special Research Assistant and Senior Research Fellow  
Consultant to the Director  
Consultant to the Director  
Consultant to the Director  
Director Emeritus
- 1 ELECTRICITY**  
.1 Resistance and Reactance  
.2 Electrochemistry  
.3 Electrical Instruments  
.4 Magnetic Measurements  
.5 Dielectrics
- 2 METROLOGY**  
.1 Photometry and Colorimetry  
.2 Refractometry  
.3 Photographic Research  
.4 Length  
.5 Engineering Metrology  
.6 Mass and Scale  
.7 Volumetry and Densimetry
- 3 HEAT**  
.1 Temperature Physics  
.2 Heat Measurements  
.3 Cryogenic Physics  
.7 Equation of State  
.8 Statistical Physics
- 4 RADIATION PHYSICS**  
.1 X-Ray  
.2 Radioactivity  
.3 Radiation Theory  
.4 High Energy Radiation  
.5 Radiological Equipment  
.6 Nucleonic Instrumentation  
.7 Neutron Physics
- Dr. Allen V. Astin  
Dr. Robert D. Huntoon  
Dr. Archibald T. McPherson  
Dr. Edward W. Wichers  
Sarah Ann Jones  
Dr. Irl C. Schoonover  
Dr. Carl O. Muehlhause  
Dr. Charles M. Herzfeld (Acting)  
Robert S. Walleigh  
William A. Wildhack  
Dr. Frederick W. Brown  
Dr. Ugo Fano  
Dr. Leon F. Curtiss  
Dr. James I. Hoffman  
Dr. Kurt E. Shuler  
Dr. Lyman J. Briggs
- Dr. Chester H. Page  
Dr. James L. Thomas  
Dr. Walter J. Hamer  
Dr. Francis M. Defandorf  
Irvin L. Cooter  
Dr. John D. Hoffman
- Alvin G. McNish  
Louis E. Barbrow  
Dr. Francis E. Washer  
Calvin S. McCamy  
Benjamin L. Page  
Irvin H. Fullmer  
Alvin G. McNish (Acting)  
John C. Hughes (Acting)
- Dr. Ralph P. Hudson  
James F. Swindells  
Dr. Defoe C. Ginnings  
Dr. Ernest Ambler  
Joseph Hilsenrath  
Dr. Melville S. Green
- Dr. Lauriston S. Taylor  
Dr. Harold O. Wyckoff  
Dr. Wilfrid B. Mann  
Dr. Lewis V. Spencer (Acting)  
Dr. Herman W. Koch  
Dr. Scott W. Smith  
Louis Costrell  
Dr. Randall S. Caswell

- |           |   |                                  |
|-----------|---|----------------------------------|
| <b>5</b>  | <b>ANALYTICAL AND INORGANIC CHEMISTRY</b> | Dr. Irl C. Schoonover (Acting)   |
|           | .1 Pure Substances                        | Dr. Frank L. Howard              |
|           | .2 Spectrochemistry                       | Bourdon F. Scribner              |
|           | .3 Solution Chemistry                     | Dr. Roger G. Bates               |
|           | .4 Standard Reference Materials           | John L. Hague                    |
|           | .5 Applied Analytical Research            | Dr. John K. Taylor               |
| <b>6</b>  | <b>MECHANICS</b>                          | Bruce L. Wilson                  |
|           | .1 Sound                                  | Dr. Richard K. Cook              |
|           | .2 Pressure and Vacuum                    | Dr. Daniel P. Johnson            |
|           | .3 Fluid Mechanics                        | Dr. Galen B. Schubauer           |
|           | .4 Engineering Mechanics                  | Lafayette K. Irwin               |
|           | .5 Rheology                               | Dr. Robert S. Marvin             |
|           | .8 Combustion Controls                    | Frank R. Caldwell                |
| <b>7</b>  | <b>ORGANIC AND FIBROUS MATERIALS</b>      | Dr. Gordon M. Kline              |
|           | .1 Rubber                                 | Dr. Lawrence A. Wood             |
|           | .2 Textiles                               | Dr. Herbert F. Schiefer          |
|           | .3 Paper                                  | Dr. Robert B. Hobbs              |
|           | .4 Leather                                | Dr. Joseph R. Kanagy             |
|           | .5 Testing and Specifications             | Dr. Robert D. Stiehler           |
|           | .6 Polymer Structure                      | Dr. Norman P. Bekkedahl          |
|           | .7 Plastics                               | Dr. Frank W. Reinhart            |
|           | .8 Dental Research                        | William T. Sweeney               |
| <b>8</b>  | <b>METALLURGY</b>                         | Dr. Lawrence M. Kushner (Acting) |
|           | .1 Thermal Metallurgy                     | Thomas G. Digges                 |
|           | .2 Chemical Metallurgy                    | LeRoy L. Wyman                   |
|           | .3 Mechanical Metallurgy                  | John A. Bennett                  |
|           | .4 Corrosion                              | George A. Ellinger               |
|           | .5 Metal Physics                          | Dr. Lawrence M. Kushner          |
|           | .6 Electrodeposition                      | Dr. Abner Brenner                |
| <b>9</b>  | <b>MINERAL PRODUCTS</b>                   | Dr. Alan D. Franklin             |
|           | .1 Engineering Ceramics                   | Milton D. Burdick                |
|           | .2 Glass                                  | Clarence H. Hahner               |
|           | .3 Refractories                           | Vacant                           |
|           | .4 Enameled Metals                        | William N. Harrison              |
|           | .5 Crystal Growth                         | Dr. Fred Ordway                  |
|           | .6 Physical Properties                    | Dr. Alan D. Franklin (Acting)    |
|           | .7 Constitution and Microstructure        | Howard F. McMurdie               |
| <b>10</b> | <b>BUILDING RESEARCH</b>                  | Douglas E. Parsons               |
|           | .1 Structural Engineering                 | David Watstein                   |
|           | .2 Fire Research                          | Dr. Alexander F. Robertson       |
|           | .3 Mechanical Systems                     | Paul R. Achenbach                |
|           | .4 Organic Building Materials             | Dr. William W. Walton            |
|           | .5 Codes and Safety Standards             | Richard L. Lloyd (Acting)        |
|           | .6 Heat Transfer                          | Henry E. Robinson                |
|           | .7 Inorganic Building Materials           | Raymond L. Blaine                |

- 11 APPLIED MATHEMATICS**  
.1 Numerical Analysis  
.2 Computation  
.3 Statistical Engineering  
.4 Mathematical Physics
- 12 DATA PROCESSING SYSTEMS**  
.1 Components and Techniques  
.2 Digital Circuitry  
.3 Digital Systems  
.4 Analog Systems  
.5 Applications Engineering
- 13 ATOMIC PHYSICS**  
.1 Spectroscopy  
.2 Infrared Spectroscopy  
.4 Solid State Physics  
.5 Electron Physics  
.6 Atomic Physics
- 14 INSTRUMENTATION**  
.1 Engineering Electronics  
.2 Electron Devices  
.3 Electronic Instrumentation  
.4 Mechanical Instruments  
.5 Basic Instrumentation
- 15 PHYSICAL CHEMISTRY**  
.1 Thermochemistry  
.2 Surface Chemistry  
.3 Organic Chemistry  
.4 Molecular Spectroscopy  
.5 Molecular Kinetics  
.6 Mass Spectrometry  
.7 Molecular Structure and Radiation Chemistry
- 32 OFFICE OF WEIGHTS AND MEASURES**
- 34 OFFICE OF TECHNICAL INFORMATION**  
.1 Information  
.2 Editorial  
.3 Publications  
.4 Photographic Services  
.5 Graphic Arts
- 40 ACCOUNTING**  
.1 Reports and Billing  
.2 Classification  
.3 Tabulation  
.4 Voucher Examination  
.6 Payroll
- Dr. Edward W. Cannon  
Dr. Philip J. Davis  
Dr. Don I. Mittleman  
Dr. Churchill Eisenhart  
Dr. William H. Pell
- Samuel N. Alexander  
Robert D. Elbourn  
Vacant  
Dr. Harold K. Skramstad  
Dr. Harold K. Skramstad  
Ezra Glaser (Acting)
- Dr. Lewis M. Branscomb  
Dr. Karl G. Kessler  
Dr. Earle K. Plyler  
Dr. Hans P. R. Frederikse  
Dr. Ladislaus L. Marton  
Dr. Stephen J. Smith
- G. Franklin Montgomery  
Gustave Shapiro  
Charles P. Marsden  
G. Franklin Montgomery (Acting)  
Arnold Wexler  
Joshua Stern
- Dr. Merrill B. Wallenstein  
Edward J. Prosen  
Dr. Ralph Klein  
Dr. Horace S. Isbell  
Dr. David E. Mann  
Dr. Robert E. Ferguson  
Dr. Vernon H. Dibeler  
Floyd Buckley
- William S. Bussey
- W. Reeves Tilley  
Paul E. Walsh  
William K. Gautier  
John E. Carpenter  
Warren P. Richardson  
Conrad F. Peters
- James P. Menzer  
Pearl E. Miller  
Robert J. Goldsmith  
Walter G. Shackelford  
Matilda Udoff  
Kathryn L. Rock



<b>41</b>	<b>PERSONNEL</b>	George R. Porter
.2	Recruitment and Placement	Frankie R. Keyser
.3	Salary and Wage Administration	Charles V. Ramey
.4	Employee Relations and Training	Ruth B. Armsby
.5	Operations and Procedures	Helen V. Courtney
.6	Medical Office	Dr. Glen Pincock
<b>42</b>	<b>ADMINISTRATIVE SERVICES</b>	Harry P. Dalzell
.1	Records and Communications	Howard L. Sampson
.2	Special Services	Karl L. Hafen (Acting)
.3	Janitorial Services	Robert C. Howey
.4	Guard Services	Capt. William J. Kane
.5	Transportation Services	Charles W. Anderson
.6	Security Office	Harry P. Dalzell
.7	Test Administration	Randolph K. Artz
<b>43</b>	<b>SHOPS</b>	Frank P. Brown
.1	Instrument Shop #1	John R. Hettenhouser
.2	Instrument Shop #2	George A. Rheinbold
.3	Instrument Shop #3	George A. Rheinbold
.4	Instrument Shop #4	Philip Pfaff, Jr.
.5	Instrument Shop #5	John L. Pararas
.7	Welding and Sheet Metal Shop	Harold E. Brown
.8	Optical Shop	Frank P. Brown (Acting)
.9	Tool Crib	Lewis H. Brigham
.11	Glassblowing Shop	Leonardo Testa
<b>44</b>	<b>SUPPLY</b>	George B. Kefover
.3	Procurement	Charles B. Kipps
.4	Property Management	Fred H. Johncox
<b>45</b>	<b>MANAGEMENT PLANNING</b>	Ivan Asay
<b>46</b>	<b>BUDGET</b>	Dr. James E. Skillington, Jr.
<b>47</b>	<b>INTERNAL AUDIT</b>	Jacob Seidenberg
<b>50</b>	<b>PLANT</b>	Hylton Graham
.1	Heating and Air Conditioning	James S. Powers
.2	Electric Shop	George V. Hall
.3	Piping	Raymond A. Watson
.4	Construction Shop	John A. King
.5	Paint Shop	Howell C. Walker
.6	Labor Services	Roy B. Powell
.7	Metal Shop	Donald I. Thompson
.9	Grounds	William R. Stevenson

**\*BOULDER LABORATORIES**

**79 DIRECTOR'S OFFICE**

Director for the Boulder Laboratories  
Executive Officer  
Consultant— Math-Analysis and Computation  
Facility Group  
Consultant— Mathematical Physics  
and Educational Director  
Consultant— Statistics  
Consultant— Astrophysics  
Consultant— Astrophysics  
Consultant— Radio Wave Propagation

Dr. Frederick W. Brown  
Samuel W. J. Welch

Dr. John J. Sopka

H. E. Brown  
Dr. Edwin L. Crow  
Dr. Richard N. Thomas  
Dr. John T. Jefferies  
Dr. James R. Wait

**80 ADMINISTRATIVE**

- .1 Management Planning
- .2 Fiscal Office
- .3 Personnel
- .4 Supply
- .5 Engineering Services
- .6 Office Services

Samuel W. J. Welch  
Jessie B. Berkley  
Herbert D. Stansell  
Roy W. Stockwell, Jr.  
Barton F. Betts  
Paul S. Ballif  
Richard G. Bulgin

**81 CRYOGENIC ENGINEERING LABORATORY**

- .1 Cryogenic Equipment
- .2 Cryogenic Processes
- .3 Properties of Materials
- .4 Cryogenic Technical Services

Russell B. Scott  
Dr. Robert B. Jacobs  
Bascom W. Birmingham  
Dr. R. Joseph Corruccini  
Victor J. Johnson

**84 RADIO STANDARDS LABORATORY**

- .1 HF Electrical Standards
- .2 Radio Broadcast Service
- .3 Radio and Microwave Materials
- .4 Atomic Frequency and Time Interval Standards
- .5 Electronic Calibration Center
- .7 Millimeter-Wave Research
- .8 Microwave Circuit Standards

Dr. John M. Richardson  
Myron C. Selby  
Alvin H. Morgan  
John L. Dalke  
Dr. Richard C. Mockler  
Harvey W. Lance  
Dr. William Culshaw  
Robert W. Beatty

**CENTRAL RADIO PROPAGATION LABORATORY**

Dr. Frederick W. Brown (Acting)

**82 IONOSPHERE RESEARCH AND PROPAGATION**

- .1 LF and VLF Research
- .2 Ionosphere Research
- .3 Prediction Services
- .4 Sun-Earth Relationships
- .5 Field Engineering
- .6 Radio Warning Services

Dr. Ernest K. Smith, Jr.  
A. Glenn Jean, Jr.  
Dr. Kenneth Davies  
Walter B. Chadwick  
Robert W. Knecht  
Harry G. Sellery  
J. Virginia Lincoln

**83 RADIO PROPAGATION ENGINEERING**

- .1 Data Reduction Instrumentation
- .4 Radio Noise
- .5 Tropospheric Measurements
- .6 Tropospheric Analysis
- .7 Propagation-Terrain Effects
- .8 Radio Meteorology
- .9 Lower Atmosphere Physics

Kenneth A. Norton  
Walter E. Johnson  
William Q. Crichlow  
Martin T. Decker  
Philip L. Rice  
Robert S. Kirby  
Bradford R. Bean  
Dr. Moody C. Thompson, Jr.

**85 RADIO SYSTEMS**

- .2 HF and VHF Research
- .4 Modulation Research
- .5 Antenna Research
- .6 Navigation Systems

Richard C. Kirby  
William F. Utlaut  
William C. Coombs  
Herman V. Cottony  
Gifford Hefley

**87 UPPER ATMOSPHERE AND SPACE PHYSICS**

- .1 Upper Atmosphere and Plasma Physics
- .5 Ionosphere and Exosphere Scatter
- .7 Airglow and Aurora
- .8 Ionospheric Radio Astronomy

Dr. C. Gordon Little  
Roger M. Gallet  
Dr. Kenneth L. Bowles  
Dr. Franklin E. Roach  
Robert S. Lawrence

\* Laboratories located in Boulder, Colorado.

**FIELD STATIONS**

**2 METROLOGY**

Lamp Inspector, Brookline, MA  
Visual Landing Aids Field Laboratory, Arcata, CA  
Master Railway Track Scale Depot, Clearing, IL

**10 BUILDING TECHNOLOGY**

Concreting Materials Section  
Allentown, PA  
Denver, CO  
San Francisco, CA  
Seattle WA

**CENTRAL RADIO PROPAGATION LABORATORY**

Anchorage Station, Anchorage, AK  
Antarctica Station, Byrd & South Pole  
Barrow Station, Barrow, AK  
Bill Station, Douglas WY  
Cheyenne Mountain Station, Colorado Springs, CO  
Fort Belvoir Station, Fort Belvoir, VA  
Fritz Peak Station, Rollinsville, CO  
Front Royal Station, Front Royal, VA  
Gun Barrel Hill Station, Boulder, CO  
Hygiene Station, Boulder, CO  
Kekaha Station, Koloa, Kauai, HA  
Kolb Station, Boulder, CO  
Lafayette Site, Lafayette, CO  
Lima Site, Lima, Peru  
Long Branch Station, Havana, IL  
Maui Station WWVH, Puunene, Maui, HA  
Puerto Rico Station, Ramey AFB  
Shickley Site, Shickley, NE  
Table Mesa Station, Boulder, CO

**RADIO STANDARDS LABORATORY**

Beltsville Station WWV  
Maui Station WWVH

JANUARY 1963

- 30 DIRECTOR'S OFFICE**  
Deputy Director  
Associate Directors, Technical
- Associate Director, Administrative
- \* Director, Boulder Laboratories  
Assistant to the Director  
Assistant to the Director for Weights and Measures Administration  
Special Research Assistant and Senior Research Fellow  
Senior Research Fellow  
Consultant to the Director  
International Relations  
Director Emeritus  
Library  
NBS Reactor Program
- 1 ELECTRICITY**  
.1 Resistance and Reactance  
.2 Electrochemistry  
.3 Electrical Instruments  
.4 Magnetic Measurements  
.5 Dielectrics  
.6 High Voltage
- 2 METROLOGY**  
.1 Photometry and Colorimetry  
.2 Refractometry  
.3 Photographic Research  
.4 Length  
.5 Engineering Metrology  
.6 Mass and Scale  
.7 Volumetry and Densimetry
- 3 HEAT**  
.1 Temperature Physics  
.2 Heat Measurements  
.3 Cryogenic Physics  
.7 Equation of State  
.8 Statistical Physics
- 4 RADIATION PHYSICS**  
.1 X-Ray  
.2 Radioactivity  
.3 Radiation Theory  
.4 High Energy Radiation  
.5 Radiological Equipment  
.6 Nucleonic Instrumentation  
.7 Neutron Physics
- Dr. Allen V. Astin  
Dr. Robert D. Huntoon  
Dr. Lauriston S. Taylor (Acting)  
William A. Wildhack  
Robert S. Walleigh  
Russell B. Scott (Acting)  
George E. Auman
- William S. Bussey  
Dr. Ugo Fano  
Dr. Herbert P. Broida  
Douglas E. Parsons  
Dr. Franz L. Alt  
Dr. Lyman J. Briggs  
Sarah Ann Jones  
Dr. Carl O. Muehlhause
- Dr. Chester H. Page  
Vacant  
Dr. Walter J. Hamer  
Dr. Francis M. Defandorf  
Irvin L. Cooter  
Dr. John D. Hoffman  
Dr. F. Ralph Kotter
- Alvin G. McNish  
Louis E. Barbrow  
Dr. Francis E. Washer  
Calvin S. McCamy  
Theodore R. Young  
Irvin H. Fullmer  
Paul E. Pontius  
John C. Hughes (Acting)
- Dr. Ralph P. Hudson  
James F. Swindells  
Dr. Defoe C. Ginnings  
Dr. Ernest Ambler  
Joseph Hilsenrath  
Dr. Melville S. Green
- Dr. Herman W. Koch (Acting)  
Dr. Harold O. Wyckoff  
Dr. Wilfrid B. Mann  
Dr. Martin Berger (Acting)  
Dr. Herman W. Koch  
Dr. Scott W. Smith  
Louis Costrell  
Dr. Randall S. Caswell

- 5 ANALYTICAL AND INORGANIC CHEMISTRY**
- .1 Pure Substances
  - .2 Spectrochemistry
  - .3 Solution Chemistry
  - .4 Standard Reference Materials
  - .5 Applied Analytical Research
  - .6 Crystal Chemistry
- Dr. Harry C. Allen, Jr.  
Dr. Frank L. Howard  
Bourdon F. Scribner  
Dr. Roger G. Bates  
John L. Hague  
Dr. John K. Taylor  
H. Steffen Peiser
- 6 MECHANICS**
- .1 Sound
  - .2 Pressure and Vacuum
  - .3 Fluid Mechanics
  - .4 Engineering Mechanics
  - .5 Rheology
  - .8 Combustion Controls
- Bruce L. Wilson  
Dr. Richard K. Cook  
Dr. Daniel P. Johnson  
Dr. Galen B. Schubauer  
Lafayette K. Irwin  
Dr. Robert S. Marvin  
Frank R. Caldwell
- 7 POLYMERS**
- .1 Macromolecules Synthesis and Structure
  - .2 Polymer Chemistry
  - .3 Polymer Physics
  - .4 Polymer Characterization
  - .5 Polymer Evaluation and Testing
  - .6 Applied Polymers Standards and Research
  - .8 Dental Research
- Dr. Gordon M. Kline  
Dr. Donald McIntyre  
Dr. Leo A. Wall  
Dr. Elio Passaglia  
Dr. Norman P. Bekkedahl  
Dr. Robert D. Stiehler  
Dr. Robert B. Hobbs  
William T. Sweeney
- 8 METALLURGY**
- .1 Engineering Metallurgy
  - .3 Microscopy and Diffraction
  - .4 Metal Reactions
  - .5 Metal Physics
  - .6 Electrolysis and Metal Deposition
- Dr. Lawrence M. Kushner  
Samuel J. Rosenberg  
Herbert C. Vacher  
George A. Ellinger  
Dr. Lawrence M. Kushner  
Dr. Abner Brenner
- 9 INORGANIC SOLIDS**
- .1 Engineering Ceramics
  - .2 Glass
  - .3 Solid State Chemistry
  - .5 Crystal Growth
  - .6 Physical Properties
  - .7 Crystallography
- Dr. Alan D. Franklin  
Milton D. Burdick  
Clarence H. Hahner  
Vacant  
Dr. Fred Ordway  
Dr. John B. Wachtman, Jr.  
Howard F. McMurdie
- 10 BUILDING RESEARCH**
- .1 Structural Engineering
  - .2 Fire Research
  - .3 Mechanical Systems
  - .4 Organic Building Materials
  - .5 Codes and Safety Standards
  - .6 Heat Transfer
  - .7 Inorganic Building Materials
  - .9 Metallic Building Materials
- Dr. Allan A. Bates  
David Watstein  
Dr. Alexander F. Robertson  
Paul R. Achenbach  
Dr. William W. Walton  
Vacant  
Henry E. Robinson  
Dr. Bruce E. Foster  
William N. Harrison
- 11 APPLIED MATHEMATICS**
- .1 Numerical Analysis
  - .2 Computation
  - .3 Statistical Engineering
  - .4 Mathematical Physics
  - .5 Operations Research
- Dr. Edward W. Cannon  
Dr. Philip J. Davis  
Dr. Don I. Mittleman  
Dr. Churchill Eisenhart  
Dr. William H. Pell  
Dr. Alan J. Goldman

- 12 DATA PROCESSING SYSTEMS**  
.1 Components and Techniques  
.2 Computer Technology  
.3 Measurements Automation  
.4 Engineering Applications  
.5 Systems Analysis
- 13 ATOMIC PHYSICS**  
.1 Spectroscopy  
.2 Infrared Spectroscopy  
.3 Far Ultraviolet Physics  
.4 Solid State Physics  
.5 Electron Physics  
.6 Atomic Physics  
.7 Plasma Spectroscopy
- 14 INSTRUMENTATION**  
.1 Engineering Electronics  
.2 Electron Devices  
.3 Electronic Instrumentation  
.4 Mechanical Instruments  
.5 Basic Instrumentation
- 15 PHYSICAL CHEMISTRY**  
.1 Thermochemistry  
.2 Surface Chemistry  
.3 Organic Chemistry  
.4 Molecular Spectroscopy  
.5 Elementary Processes  
.6 Mass Spectrometry  
.7 Photochemistry
- 17 OFFICE OF WEIGHTS AND MEASURES**
- 34 OFFICE OF TECHNICAL INFORMATION**  
.1 Information  
.2 Editorial  
.3 Publications  
.4 Photographic Services  
.5 Graphic Arts
- 40 ACCOUNTING**  
.1 Reports and Billing  
.2 Classification  
.3 Tabulation  
.4 Voucher Examination  
.5 Test Administration  
.6 Payroll
- 41 PERSONNEL**  
.2 Recruitment and Placement  
.3 Salary and Wage Administration  
.4 Employee Relations and Training  
.5 Operations and Procedures  
.6 Medical Office
- Samuel N. Alexander  
Robert D. Elbourn  
James A. Cunningham  
Raymond T. Moore  
Samuel N. Alexander (Acting)  
Samuel N. Alexander (Acting)
- Dr. Karl G. Kessler  
Dr. William C. Martin, Jr.  
Dr. Earle K. Plyler  
Dr. Robert P. Madden  
Dr. Hans P. R. Frederikse  
Dr. John A. Simpson  
Dr. Harold S. Boyne  
Dr. Wolfgang L. Wiese
- G. Franklin Montgomery  
Gustave Shapiro  
Charles P. Marsden  
G. Franklin Montgomery (Acting)  
Arnold Wexler  
Joshua Stern
- Dr. Merrill B. Wallenstein  
Dr. Merrill B. Wallenstein  
Dr. Ralph Klein  
Dr. Horace S. Isbell  
Dr. David E. Mann  
Dr. Robert E. Ferguson  
Dr. Henry M. Rosenstock  
Dr. James R. McNesby
- Malcolm W. Jensen
- W. Reeves Tilley  
Paul E. Walsh  
William K. Gautier  
John E. Carpenter  
Warren P. Richardson  
Conrad F. Peters
- James P. Menzer  
Pearl E. Miller  
Vacant  
Walter G. Shackelford  
Matilda Udoff  
Mark D. Cassidy  
Kathryn L. Rock
- George R. Porter  
Henry C. Bothe  
Charles V. Ramey  
Ruth B. Armsby  
Helen V. Courtney  
Dr. Glen Pincock

<b>42</b>	<b>ADMINISTRATIVE SERVICES</b>	
	.1	Records and Communications
	.2	Special Services
	.3	Janitorial Services
	.4	Guard Services
	.5	Transportation Services
	.6	Security Office
		Harry P. Dalzell Howard L. Sampson Walter J. Rabbitt Robert C. Howey Capt. William J. Kane Charles W. Anderson Harry P. Dalzell
<b>43</b>	<b>SHOPS</b>	
	.1	Instrument Shop #1
	.2	Instrument Shop #2
	.3	Instrument Shop #3
	.4	Instrument Shop #4
	.5	Instrument Shop #5
	.7	Welding and Sheet Metal Shop
	.8	Optical Shop
	.9	Tool Crib
	.11	Glassblowing Shop
		Frank P. Brown John R. Hettenhouser George A. Rheinbold George A. Rheinbold Philip Pfaff, Jr. John L. Pararas Harold E. Brown Frank P. Brown (Acting) Lewis H. Brigham Leonardo Testa
<b>44</b>	<b>SUPPLY</b>	
	.3	Procurement
	.4	Property Management
		George B. Kefover Charles B. Kipps Fred H. Johncox
<b>45</b>	<b>MANAGEMENT SERVICES</b>	
		Arthur J. Muller
<b>46</b>	<b>BUDGET</b>	
		Dr. James E. Skillington, Jr.
<b>47</b>	<b>INTERNAL AUDIT</b>	
		Jacob Seidenberg
<b>50</b>	<b>PLANT</b>	
	.1	Heating and Air Conditioning
	.2	Electric Shop
	.3	Piping
	.4	Construction Shop
	.5	Paint Shop
	.6	Labor Services
	.7	Metal Shop
	.9	Grounds
		Frank P. Brown (Acting) James S. Powers Vacant Vacant John A. King Howell C. Walker Roy B. Powell Donald I. Thompson William R. Stevenson
<b>*BOULDER LABORATORIES</b>		
<b>79</b>	<b>Director's Office</b>	
	Executive Officer	Russell B. Scott (Acting)
	Consultant— Math Group, Computation Facility	Samuel W. J. Welch
	Consultant— Mathematical Physics and Educational	Dr. John J. Sopka
	Director	
	Consultant— Statistics	H. E. Brown
	Consultant— Radio Wave Propagation	Dr. Edwin L. Crow
	Consultant— Physics of the Atmosphere	Dr. James R. Wait Dr. David M. Gates

- 80 ADMINISTRATIVE**
- .1 Management Planning
  - .2 Fiscal Office
  - .3 Personnel
  - .4 Supply
  - .5 Engineering Services
  - .6 Office Services
  - .7 Plant
  - .8 Shops
- Samuel W. J. Welch  
 Jessie B. Berkley  
 Herbert D. Stansell  
 Roy W. Stockwell, Jr.  
 Barton F. Betts  
 Paul S. Ballif  
 Richard G. Bulgin  
 Edgar A. Yuzwiak  
 John L. Hutton
- 81 CRYOGENIC ENGINEERING LABORATORY**
- .1 Cryogenic Equipment
  - .2 Cryogenic Processes
  - .3 Properties of Materials
  - .4 Cryogenic Technical Services
- Bascom W. Birmingham (Acting)  
 Dr. Robert B. Jacobs  
 Bascom W. Birmingham  
 Dr. R. Joseph Corruccini  
 Victor J. Johnson
- CENTRAL RADIO PROPAGATION LABORATORY**
- Dr. C. Gordon Little
- 82 IONOSPHERE RESEARCH AND PROPAGATION**
- .5 Ultra Low Frequency Research
  - .1 LF and VLF Research
  - .2 Ionosphere Research
  - .3 Prediction Services
  - .4 Sun-Earth Relationships
  - .5 Field Engineering
  - .6 Radio Warning Services
  - .7 Vertical Soundings Research
- Dr. Ernest K. Smith, Jr.  
 Dr. Wallace H. Campbell  
 A. Glenn Jean, Jr.  
 Dr. Kenneth Davies  
 M. Pokempner (Acting)  
 Robert W. Knecht  
 Harry G. Sellery  
 J. Virginia Lincoln  
 John W. Wright
- 83 TROPOSPHERE AND SPACE TELECOMMUNICATIONS**
- .1 Data Reduction Instrumentation
  - .4 Radio Noise
  - .5 Tropospheric Measurements
  - .6 Tropospheric Analysis
  - .7 Propagation-Terrain Effects
  - .8 Radio Meteorology
  - .9 Lower Atmosphere Physics
- Kenneth A. Norton  
 Walter E. Johnson  
 William Q. Crichlow  
 Martin T. Decker  
 Philip L. Rice  
 Robert S. Kirby  
 Bradford R. Bean  
 Dr. Moody C. Thompson, Jr.
- 85 RADIO SYSTEMS**
- .1 Applied Electromagnetic Theory
  - .2 HF and VHF Research
  - .3 Frequency Utilization
  - .4 Modulation Research
  - .5 Antenna Research
  - .6 Radiodetermination
- Richard C. Kirby  
 J. Ralph Johler  
 William F. Utlaut  
 George W. Haydon  
 Clark C. Watterson (Acting)  
 Herman V. Cottony  
 Gifford Hefley
- 87 UPPER ATMOSPHERE AND SPACE PHYSICS**
- .1 Upper Atmosphere and Plasma Physics
  - .2 High Latitude Ionospheric Physics
  - .5 Ionosphere and Exosphere Scatter
  - .7 Airglow and Aurora
  - .8 Ionospheric Radio Astronomy
- Dr. C. Gordon Little  
 Roger M. Gallet  
 Dr. Hugh J. A. Chivers  
 Dr. Kenneth L. Bowles  
 Dr. Franklin E. Roach  
 Robert S. Lawrence



**RADIO STANDARDS LABORATORY**

Dr. John M. Richardson

**91 RADIO STANDARDS PHYSICS**

- .2 Radio Broadcast Service
- .3 Radio and Microwave Materials
- .4 Atomic Frequency and Time Interval Standards
- .6 Radio Plasma
- .7 Millimeter-Wave Research

Dr. L. Yardley Beers  
Alvin H. Morgan  
John L. Dalke  
Dr. Richard C. Mockler  
Dr. Karl B. Persson  
Dr. Robert W. Zimmerer (Acting)

**92 RADIO STANDARDS ENGINEERING**

- .1 HF Electrical Standards
- .2 HF Calibration Services
- .3 HF Impedance Standards
- .7 Microwave Calibration Services
- .8 Microwave Circuit Standards
- .9 Low Frequency Calibration Services

Dr. George E. Schafer  
Charles M. Allred  
Robert C. Powell (Acting)  
Robert C. Powell  
Roy E. Larson  
Robert W. Beatty  
Frank D. Weaver (Acting)

**95 JOINT INSTITUTE FOR LABORATORY ASTROPHYSICS,  
NBS GROUP**

Dr. Lewis M. Branscomb

\* Laboratories located in Boulder, Colorado.

**FIELD STATIONS**

**2 METROLOGY**

Visual Landing Aids Field Laboratory, Arcata, CA  
Master Railway Track Scale Depot, Clearing, IL

**10 BUILDING RESEARCH**

Inorganic Building Materials Section  
Denver, CO  
San Francisco, CA  
Seattle WA

**CENTRAL RADIO PROPAGATION LABORATORY**

Anchorage Station, Anchorage, AK  
Antarctica Station, Byrd & South Pole  
Barrow Station, Barrow, AK  
Bill Station, Douglas WY  
Broadcast Station WWV, Greenbelt, MD  
Broadcast Station WWVH, Puunene, Maui, HA  
Cheyenne Mountain Station, Colorado Springs, CO  
Erie Station, Erie, CO  
Fort Belvoir Station, Fort Belvoir, VA  
Fritz Peak Station, Rollinsville, CO  
Front Royal Station, Front Royal, VA  
Gun Barrel Hill Station, Boulder, CO  
Hygiene Station, Boulder, CO  
Kekaha Station, Koloa, Kauai, HA  
Kolb Station, Boulder, CO  
Lafayette Site, Lafayette, CO  
Lima Site, Lima, Peru  
Long Branch Station, Havana, IL  
Puerto Rico Station, Ramey AFB  
Shickley Site, Shickley, NE  
Table Mesa Station, Boulder, CO

July 1, 1964

- 100 OFFICE OF THE DIRECTOR**  
Director  
Deputy Director  
Assistant to the Director  
Assistant to the Director  
Assistant to the Director, Automatic Data Processing  
Senior Research Fellow  
Senior Research Fellow  
Senior Research Fellow
- 102 OFFICE OF PUBLIC INFORMATION**
- 103 TECHNICAL ANALYSIS GROUP**
- 104 OFFICE OF PROGRAM PLANNING AND EVALUATION**  
Associate Director for Resources Planning
- 120 ASSOCIATE DIRECTOR FOR ADMINISTRATION**  
Associate Director
- 121 ACCOUNTING**  
Deputy Chief  
.01 Reports and Billing  
.02 Classification  
.03 Tabulation  
.04 Voucher Examination  
.05 Payroll
- 122 ADMINISTRATIVE SERVICES**  
Assistant Chief  
.01 Records and Communications  
.02 Special Services  
.03 Janitorial Services  
.04 Guard Services  
.05 Transportation Services  
.06 Security Office
- 123 BUDGET AND MANAGEMENT**  
.01 Budget  
.02 Management Analysis
- 124 INTERNAL AUDIT**
- 125 PERSONNEL**  
Assistant Chief  
.01 Board of Civil Service Examiners  
.02 Recruitment and Placement  
.03 Salary and Wage Administration  
.04 Employee Relations and Training  
.05 Operations and Procedures  
.06 Medical Office
- Dr. Allen V. Astin  
Dr. Irl C. Schoonover  
George E. Auman  
Clarence N. Coates  
W. Howard Gammon  
Dr. Churchill Eisenhart  
Dr. Ugo Fano  
Dr. James R. Wait
- A. Victor Gentilini
- Dr. Shirleigh Silverman
- Robert S. Walleigh
- Jacob Seidenberg  
Homer McIntyre  
Pearl E. Miller  
Edgar H. MacArthur  
Frederick I. Baum (Acting)  
Matilda Udoff  
Kathryn L. Rock
- Harry P. Dalzell  
Karl L. Hafen  
Howard L. Sampson  
Walter J. Rabbitt  
Robert C. Howey  
Capt. William J. Kane  
Charles W. Anderson  
Harry P. Dalzell
- Dr. James E. Skillington, Jr.  
Eugene C. Denne  
John B. Tallerico
- Harold F. Whittington
- George R. Porter  
Henry C. Bothe  
Warren J. Barker  
Henry C. Bothe  
Charles V. Ramey  
Ruth B. Armsby  
Edith C. Lewis  
Dr. A. S. Cross

- 126 PLANT**  
 Assistant Chief  
 .01 Steam-Chilled Water Generation  
 .02 Electric Shop  
 .03 Piping  
 .04 Construction Shop  
 .05 Gaithersburg Plant Services  
 .06 Labor Services  
 .07 Metal Shop  
 .08 Air Conditioning and Refrigeration  
 .09 Grounds
- 127 SUPPLY**  
 Deputy Chief  
 .01 Storeroom  
 .02 General Services  
 .03 Procurement  
 .04 Property Management
- 140 ASSOCIATE DIRECTOR FOR TECHNICAL SUPPORT**  
 Associate Director
- 141 TECHNICAL PUBLICATIONS**  
 Assistant Chief  
 .01 Information  
 .02 Editorial  
 .03 Publications  
 .04 Photographic Services  
 .05 Graphic Arts
- 142 RESEARCH INFORMATION**  
 .01 Library
- 143 RADIATION SAFETY**  
 .01 Health Services
- 144 PROFESSIONAL DEVELOPMENT**
- 154 INSTRUMENT SHOPS**  
 Assistant Chief  
 .01 Instrument Shop #1  
 .02 Instrument Shop #2  
 .03 Instrument Shop #3  
 .04 Instrument Shop #4  
 .05 Instrument Shop #5  
 .06 Glassblowing  
 .07 Welding and Sheet Metal Shop  
 .08 Optical Shop  
 .09 Tool Crib
- M. Bernard Goetz (Acting)  
 M. Bernard Goetz  
 James S. Powers  
 Robert W. Miller  
 Gerard John Finan  
 John A. King  
 Berkley E. Wigglesworth  
 Roy B. Powell  
 Donald I. Thompson  
 Donald I. Thompson  
 William R. Stevenson
- George B. Kefover  
 Arthur L. Longwell  
 Walter C. Bonner (Acting)  
 Fred H. Johncox (Acting)  
 Charles B. Kipps  
 Harold G. Nicholas
- Dr. Lauriston S. Taylor
- W. Reeves Tilley  
 William K. Gautier  
 Robert T. Cook (Acting)  
 William K. Gautier  
 John E. Carpenter  
 Warren P. Richardson  
 Conrad F. Peters
- Dr. Lauriston S. Taylor (Acting)  
 Sarah Ann Jones
- Dr. Lauriston S. Taylor (Acting)  
 Dr. Abraham Schwebel
- Vacant
- Frank P. Brown  
 Winfield L. Drissel  
 John R. Hettenhouser  
 Walter A. Koepper  
 Charles E. Taylor  
 Philip Pfaff, Jr.  
 Philip Pfaff, Jr.  
 Enrico Deleonibus  
 Harold E. Brown  
 Stanley W. Gerner  
 Lewis H. Brigham

**\*160 MANAGER, BOULDER LABORATORIES**

**OFFICE OF THE MANAGER, BOULDER LABORATORIES**

Manager  
Consultant—Statistics  
Consultant—Math Group and Computation Facility  
Consultant—Mathematical Physics

Russell B. Scott  
Dr. Edwin L. Crow  
Dr. John J. Sopka  
H. E. Brown

**\*161 ADMINISTRATIVE, BOULDER LABORATORIES**

.01 Consultant—Engineering  
.10 Management Planning  
.20 Personnel  
.30 Fiscal  
.40 Supply  
.50 Office Services  
.60 Plant Engineering  
.70 Shops

Samuel W. J. Welch  
Paul S. Ballif  
Mrs. J. Berkley  
Roy W. Stockwell  
Herbert D. Stansell  
Barton F. Betts  
Richard G. Bulgin  
Edgar A. Yuzwiak  
John L. Hutton

**200 INSTITUTE FOR BASIC STANDARDS**

Director  
Associate Director, Measurement Services

Dr. Robert D. Huntoon  
William A. Wildhack

**201 OFFICE OF STANDARD REFERENCE DATA**

Thermodynamics and Transport Data  
Chemical Kinetics  
Information Systems

Dr. Edward L. Brady  
Dr. Everett R. Johnson  
Dr. Stephen A. Rossmassler  
Dr. Franz L. Alt

**205 APPLIED MATHEMATICS**

Consultant  
Consultant  
Consultant  
.01 Numerical Analysis  
.02 Computation  
.03 Statistical Engineering  
.04 Mathematical Physics  
.05 Operations Research

Dr. Edward W. Cannon  
Dr. Hansjorg Oser  
Ida Rhodes  
Dr. William J. Youden  
Dr. Morris Newman  
Dr. Don I. Mittleman  
Joseph M. Cameron  
Dr. William H. Pell  
Dr. Alan J. Goldman

**211 ELECTRICITY**

.01 Resistance and Reactance  
.02 Electrochemistry  
.03 Electrical Instruments  
.04 Magnetic Measurements  
.05 Dielectrics  
.06 High Voltage  
.07 Absolute Electrical Measurements

Dr. Chester H. Page  
Chester Peterson  
Dr. Walter J. Hamer  
Francis L. Hermach  
Irvin L. Cooter  
Dr. Arnold H. Scott  
Dr. F. Ralph Kotter  
Dr. Forest K. Harris

**212 METROLOGY**

Assistant Chief  
.11 Photometry and Colorimetry  
.12 Refractometry  
.13 Photographic Research  
.21 Length  
.22 Engineering Metrology  
.31 Mass and Volume

Alvin G. McNish  
Dr. Deane B. Judd  
Louis E. Barbrow  
Dr. Francis E. Washer  
Calvin S. McCamy  
Theodore R. Young  
Irvin H. Fullmer  
Paul E. Pontius

- 213 MECHANICS**  
 Consultant  
 Consultant  
 .01 Sound  
 .02 Pressure and Vacuum  
 .03 Fluid Mechanics  
 .04 Engineering Mechanics  
 .05 Rheology  
 .06 Combustion Controls
- 221 HEAT**  
 Assistant Chief, Thermodynamics  
 .01 Temperature Physics  
 .02 Heat Measurements  
 .03 Cryogenic Physics  
 .04 Equation of State  
 .05 Statistical Physics
- 222 ATOMIC PHYSICS**  
 .01 Spectroscopy  
 .02 Infrared and Microwave Spectroscopy  
 .03 Far Ultraviolet Physics  
 .04 Solid State Physics  
 .05 Electron Physics  
 .06 Atomic Physics  
 .07 Plasma Spectroscopy
- 223 PHYSICAL CHEMISTRY**  
 Consultant  
 Consultant  
 .01 Chemical Kinetics Information Center  
 .02 Theoretical Chemistry  
 .11 Thermochemistry  
 .21 Surface Chemistry  
 .31 Organic Chemistry  
 .41 Molecular Spectroscopy  
 .51 Elementary Processes  
 .52 Mass Spectrometry  
 .53 Photo Chemistry and Radiation Chemistry
- \*224 LABORATORY ASTROPHYSICS**
- 231 RADIATION PHYSICS**  
 .01 Radiation Theory
- RADIOLOGICAL PHYSICS BRANCH**  
 .11 X-ray Physics  
 .12 Dosimetry  
 .13 X-ray Standards
- NUCLEAR PHYSICS BRANCH**  
 .21 Radioactivity  
 .22 Neutron Physics  
 .23 Photonuclear Physics  
 .24 Nuclear Spectroscopy
- Bruce L. Wilson  
 Dr. John M. Frankland  
 Edward C. Lloyd  
 Dr. Richard K. Cook  
 Dr. Daniel P. Johnson  
 Dr. Galen B. Schubauer  
 Lafayette K. Irwin  
 Dr. Robert S. Marvin  
 Frank R. Caldwell
- Dr. Ralph P. Hudson  
 Dr. Charles W. Beckett  
 James F. Swindells  
 Dr. Defoe C. Ginnings  
 Dr. Ernest Ambler  
 Joseph Hilsenrath  
 Dr. Melville S. Green
- Dr. Karl G. Kessler  
 Dr. William C. Martin, Jr.  
 Dr. David R. Lide, Jr.  
 Dr. Robert P. Madden  
 Dr. Hans P. R. Frederikse  
 Dr. John A. Simpson  
 Dr. Harold S. Boyne  
 Dr. Wolfgang L. Wiese
- Dr. Merrill B. Wallenstein  
 Dr. William L. Clinton  
 Edward J. Prosen  
 Dr. Ransom B. Parlin  
 Dr. Morris Krauss  
 Donald D. Wagman  
 Dr. Ralph Klein  
 Dr. Horace S. Isbell  
 Dr. David E. Mann  
 Dr. Robert E. Ferguson  
 Dr. Harry M. Rosenstock  
 Dr. James R. McNesby
- Dr. Lewis M. Branscomb
- Dr. Herman W. Koch  
 Dr. Haakon A. Olsen
- Dr. J. W. Motz  
 Dr. J. W. Motz  
 Dr. Scott W. Smith  
 Dr. Harold O. Wyckoff
- Dr. Herman W. Koch  
 Dr. Wilfrid B. Mann  
 Dr. Randall S. Caswell  
 Dr. Everett G. Fuller  
 Dr. Raymond W. Hayward

- Accelerator Branch**  
.31 Accelerator Engineering  
.32 Radiation Physics Instrumentation  
.33 Accelerator Physics
- \*250 RADIO STANDARDS LABORATORY**  
Scientific Consultant
- \*251 RADIO STANDARDS PHYSICS**  
Assistant Chief  
Consultant  
.01 Frequency-Time Dissemination Research  
.02 Frequency-Time Broadcast Services  
.03 Radio and Microwave Materials  
.04 Atomic Frequency and Time Interval Standards  
.06 Radio Plasma  
.07 Microwave Physics
- \*252 RADIO STANDARDS ENGINEERING**  
Consultant  
Consultant  
.11 Low Frequency Calibration Services  
.21 HF Calibration Services  
.22 HF Electrical Standards  
.23 HF Impedance Standards  
.31 Microwave Calibration Services  
.32 Microwave Circuit Standards
- 300 INSTITUTE FOR MATERIALS RESEARCH**  
Director  
Deputy Director
- 302 OFFICE OF STANDARD REFERENCE MATERIALS**
- 310 ANALYTICAL CHEMISTRY**  
Assistant Chief  
.01 Radiochemical Analysis  
.02 Spectrochemical Analysis  
.03 Electrochemical Analysis  
.04 Quantitative Separations  
.05 Analysis and Purification
- 311 POLYMERS**  
Consultant  
Consultant on Polymers  
Consultant on Rubber  
.01 Macromolecules, Synthesis and Structure  
.02 Polymer Chemistry  
.03 Polymer Physics  
.04 Polymer Characterization  
.05 Dental Research
- Dr. James E. Leiss  
Dr. James E. Leiss  
Louis Costrell  
Dr. James E. Leiss
- Dr. John M. Richardson  
Dr. David M. Kerns
- Dr. L. Yardley Beers  
Dr. George E. Hudson  
Dr. Paul F. Wacker  
Alvin H. Morgan  
David H. Andrews  
John L. Dalke  
Dr. Richard C. Mockler  
Dr. Karl B. Persson  
Dr. Robert W. Zimmerer (Acting)
- Dr. George E. Schafer  
Robert W. Beatty  
Myron C. Selby  
Frank D. Weaver (Acting)  
Dr. K. R. Wendt  
Charles M. Allred  
Robert C. Powell  
Roy E. Larson  
Dr. Maurice B. Hall
- Dr. Irl C. Schoonover (Acting)  
Dr. Harry C. Allen Jr. (Acting)
- Dr. W. Wayne Meinke
- Dr. W. Wayne Meinke  
Dr. Roger G. Bates  
Dr. James R. DeVoe  
Bourdon F. Scribner  
Dr. Roger G. Bates  
Rolf A. Paulson (Acting)  
Dr. John K. Taylor
- Dr. John D. Hoffman  
Dr. John I. Lauritzen, Jr.  
Dr. Samuel G. Weissberg  
Dr. Lawrence A. Wood  
Dr. Donald McIntyre  
Dr. Leo A. Wall  
Dr. Elio Passaglia  
Dr. Norman P. Bekkedahl  
William T. Sweeney

- .10 **Federal Standards and Specification Laboratory**  
 Consultant on Leather  
 Consultant on Mathematical Statistics  
 Consultant on Paper  
 Consultant on Textiles  
 .11 Product Evaluation and Testing  
 .12 Procurement Systems  
 .13 Evaluation Criteria  
 .14 Performance Research
- 312 METALLURGY**  
 Assistant Chief  
 Consultant  
 .01 Engineering Metallurgy  
 .02 Alloy Physics  
 .03 Lattice Defects and Microstructures  
 .04 Corrosion  
 .05 Metal Physics  
 .06 Electrolysis and Metal Deposition  
 .07 Crystallization of Metals
- 313 INORGANIC MATERIALS**  
 Consultant  
 Consultant  
 .01 Inorganic Chemistry  
 .02 Glass  
 .03 High Temperature Chemistry  
 .04 Crystal Chemistry  
 .05 Physical Properties  
 .06 Crystallography
- 314 REACTOR RADIATIONS**
- \*315 CRYOGENICS**  
 Assistant Chief  
 Consultant  
 .01 Cryogenic Technical Services  
 .02 Cryogenic Data Center  
 .03 Cryogenic Properties of Solids  
 .04 Properties of Cryogenic Fluids  
 .05 Cryogenic Systems  
 .06 Cryogenic Metrology  
 .07 Cryogenic Fluid Transport Processes
- 400 INSTITUTE FOR APPLIED TECHNOLOGY**  
 Director  
 Deputy Director  
 Consultant  
 Assistant to the Director, International Standards  
 .01 Pilot Projects and Programs  
 .02 Invention and Innovation  
 .03 Domestic Technology Information  
 .04 AID Technology Information
- Dr. Robert B. Hobbs (Acting)  
 Dr. Joseph R. Kanagy  
 John Mandel  
 Jack L. Harvey (Acting)  
 Dr. Herbert F. Schiefer  
 Vacant  
 Vacant  
 Dr. Robert D. Stiehler  
 Vacant
- Dr. Lawrence M. Kushner  
 George A. Ellinger  
 Leroy L. Wyman  
 Samuel J. Rosenberg  
 Dr. Lawrence H. Bennett  
 Dr. A. William Ruff, Jr.  
 George A. Ellinger  
 Dr. Robert E. Howard  
 Dr. Abner Brenner  
 Dr. Robert L. Parker
- Dr. Harry C. Allen, Jr.  
 Dr. Gilbert Gordon  
 Dr. Ellis R. Lippincott  
 Dr. Thomas D. Coyle  
 Clarence H. Hahner  
 Vacant  
 H. Steffen Peiser  
 Dr. John B. Wachtman, Jr.  
 Howard F. McMurdie
- Dr. Carl O. Muehlhause
- Bascom W. Birmingham  
 Dr. R. Joseph Corruccini  
 Alan F. Schmidt  
 William A. Wilson  
 Victor J. Johnson  
 Dr. Richard H. Kropschot  
 Dr. R. Joseph Corruccini  
 Dudley B. Chelton  
 Dr. Thomas M. Flynn  
 Raymond V. Smith
- Dr. Donald A. Schon  
 John P. Eberhard  
 Joseph L. Swedock  
 Dr. Archibald T. McPherson  
 Vacant  
 Daniel V. DeSimone  
 Eric A. Tietz  
 Vacant

402	OFFICE OF TECHNICAL SERVICES	Dr. Donald A. Schon
403	OFFICE OF INDUSTRIAL SERVICES	Robert L. Stern
404	OFFICE OF WEIGHTS AND MEASURES	Malcolm W. Jensen
405	OFFICE OF ENGINEERING STANDARDS Commodity Standards Technical Standards Coordination	Vacant Alfred S. Best Joan Hartman
410	TECHNICAL DOCUMENTATION CENTER .10 Document Management Branch .20 Document Analysis and Reference Branch .30 Automated Systems and Services Branch .40 Customer Relations Branch .50 Plans and Development Branch .60 Administrative Services Branch .70 Joint Publications Research Service	Bernard M. Fry Paul W. Larsen Lillian A. Hamrick Vacant James E. Wheat Jeremiah F. Harrington John L. Demarest Thomas W. Miller
421	BUILDING RESEARCH .01 Structural Engineering .02 Fire Research .03 Mechanical Systems .04 Organic Building Materials .05 Codes and Safety Standards .06 Heat Transfer .07 Inorganic Building Materials .08 Metallic Building Materials	Dr. Allan A. Bates David Watstein Dr. Alexander F. Robertson Paul R. Achenbach Dr. William W. Walton Dr. Allan A. Bates (Acting) Henry E. Robinson Dr. Bruce E. Foster Dwight G. Moore
422	INDUSTRIAL EQUIPMENT TECHNOLOGY	Vacant
423	INFORMATION TECHNOLOGY PILOT .01 Components and Techniques .02 Computer Technology .03 Measurements Automation .04 Engineering Applications .05 Systems Analysis	Samuel N. Alexander James P. Nigro Robert D. Elbourn James A. Cunningham Raymond T. Moore James P. Nigro Samuel N. Alexander (Acting)
424	PERFORMANCE TEST DEVELOPMENT	Vacant
425	INSTRUMENTATION .01 Engineering Electronics .02 Electron Devices .03 Electronic Instrumentation .04 Mechanical Instruments .05 Basic Instrumentation	G. Franklin Montgomery Gustave Shapiro Charles P. Marsden G. Franklin Montgomery (Acting) Arnold Wexler Joshua Stern
426	TRANSPORT SYSTEMS	Dr. Siegfried M. Breuning



- 427 TEXTILES AND APPAREL TECHNOLOGY CENTER**  
 Consultant  
 Mathematician  
 Industrial Specialist  
 Consultant  
 Consultant  
 .01 Contract Research Program  
 .02 Technical Support Program
- Robert L. Stern (Acting)  
 Gary K. Stonebraker  
 Jerome A. Yurow  
 Gary C. McKay  
 Robert H. Ramsey  
 Ernest R. Kaswell  
 Vacant  
 Vacant
- \*500 CENTRAL RADIO PROPAGATION LABORATORY**  
 Director  
 Deputy Director  
 Senior Research Fellow  
 Consultant  
 Consultant  
 Consultant  
 CRPL Liaison and Program Development  
 Consultant Radio Wave Propagation
- Dr. C. Gordon Little  
 Jack W. Herbstreit  
 Dr. James R. Wait  
 Kenneth A. Norton  
 Roger M. Gallet  
 A. Glenn Jean, Jr.  
 Alan H. Shapley  
 Dr. James R. Wait
- \*582 IONOSPHERE RESEARCH AND PROPAGATION**  
 Assistant Chief  
 Consultant  
 Consultant  
 .05 Ultra Low Frequency Research  
 .10 LF and VLF Research  
 .20 Ionosphere Research  
 .30 Prediction Services  
 .40 Sun-Earth Relationships  
 .50 Field Engineering  
 .60 Radio Warning Services  
 .70 Vertical Soundings Research
- Robert W. Knecht  
 Thomas N. Gautier  
 Dr. Lawrence R. Megill  
 Dr. H. Herbert Howe  
 Dr. Wallace H. Campbell  
 Douglass D. Crombie  
 Dr. Kenneth Davies  
 Margo Leftin  
 Dr. Thomas E. VanZandt  
 Harry G. Sellery  
 J. Virginia Lincoln  
 John W. Wright
- \*583 TROPOSPHERE AND SPACE TELECOMMUNICATIONS**  
 Consultant  
 Consultant, Terminal Equipment  
 .10 Data Reduction Instrumentation  
 .40 Radio Noise  
 .50 Tropospheric Measurements  
 .60 Tropospheric Analysis  
 .70 Spectrum Utilization Research  
 .80 Radio Meteorology  
 .90 Lower Atmosphere Physics
- Robert S. Kirby (Acting)  
 Dr. David M. Gates  
 Edwin F. Florman  
 Walter E. Johnson  
 William Q. Crichlow  
 Martin T. Decker  
 Philip L. Rice  
 Albrecht P. Barsis  
 Bradford R. Bean  
 Dr. Moody C. Thompson, Jr.
- \*585 RADIO SYSTEMS**  
 Assistant Chief  
 Assistant Chief  
 Consultant  
 .10 Applied Electromagnetic Theory  
 .20 HF and VHF Research  
 .30 Frequency Utilization  
 .40 Modulation Research  
 .50 Antenna Research  
 .60 Radiodetermination
- Richard C. Kirby  
 Donald W. Patterson  
 William F. Utlaut  
 George W. Haydon  
 J. Ralph Johler  
 Lowell H. Tveten  
 George W. Haydon  
 Clark C. Watterson  
 Herman V. Cottony  
 Gifford Hefley

**\*587 UPPER ATMOSPHERE AND SPACE PHYSICS**

- Assistant Chief
- Consultant
- Consultant
- Consultant
- .10 Upper Atmosphere and Plasma Physics
- .20 High Latitude Ionospheric Physics
- .30 Atmospheric Collision Processes
- .50 Ionosphere and Exosphere Scatter
- .70 Airglow and Aurora
- .80 Ionospheric Radio Astronomy

Dr. Ernest K. Smith, Jr.  
Dr. Floyd L. Taylor  
Dana K. Bailey  
Dr. George C. Reid  
Dr. Ralph J. Slutz  
Vacant  
Dr. Hugh J. A. Chivers  
Dr. Eldon E. Ferguson  
Dr. Kenneth L. Bowles  
Dr. Franklin E. Roach  
Robert S. Lawrence

\*Laboratories located in Boulder, Colorado.

**FIELD STATIONS**

**500 CENTRAL RADIO PROPAGATION LABORATORY**

- Radio Propagation Field Station, Anchorage, AK
- Radio Propagation Field Station, Barrow, AK
- Ionosonde and Conjugate Points Station, Byrd Station, Antarctica
- Radio Noise Station, USNS ElTanin, Antarctica
- Conjugate Points Station, Charlevoix, Quebec
- Western Test Range, Lompoc (Point Arguello), CA
- Radio Propagation Field Station, Akron, CO
- Boulder Magnetic Observatory, Boulder, CO
- Cheyenne Mountain Radio Propagation Station, Colorado Springs, CO
- HF/VHF Research Section Radio Propagation Transmissions Site, Erie, CO
- Standard Frequency Stations WWVB/WWVL, Fort Collins, CO
- Antenna Research Test Site, Green Mountain Mesa, CO
- Radio Meteorological Field Site, Radio Noise Station and Telemetry Recording Station, Gun Barrel Hill, CO
- Radio Propagation Field Station, Haswell, CO
- Ionosphere Research Field Station, Kolb, CO
- VLF/ELF Propagation Station, Lafayette, CO
- Fritz Peak Observatory, Aurora and Airglow Station, Rollinsville, CO
- Radio Propagation Research Station, Table Mesa, CO
- Radio Noise Recording Station, Koloa, Kauai, HA
- Radio Propagation and Standard Frequency Station WWVH, Puunene, Maui, HA
- Radio Propagation Transmissions Station, Havana, IL
- Standard Frequency Station WWV, Greenbelt, MD
- Radio Noise Recording Station, Warrensburg, MO
- Radio Propagation Field Station, Mangum, OK
- Jicamarca Radar Observatory, Lima, Peru
- Radio Propagation Field Station, Ft. Belvoir, VA
- Radio Noise Station, Front Royal, VA
- Ionosphere Sounding Station, Wallops Island, VA
- Bill Radio Noise Recording Station, Douglas, WY

**212 METROLOGY**

- Visual Aids Field Laboratory, Arcata, CA
- Master Railway Track Scale Depot, Clearing, IL

**410.70 TECHNICAL DOCUMENTATION CENTER, JOINT PUBLICATIONS RESEARCH SERVICE**  
San Francisco, CA  
New York, NY

**421.07 BUILDING RESEARCH, INORGANIC BUILDING MATERIALS**  
San Francisco, CA  
Denver, CO  
Seattle, WA

DECEMBER 9, 1966

<b>100 OFFICE OF THE DIRECTOR</b>	
Director	Dr. Allen V. Astin
Deputy Director	Dr. Irl C. Schoonover
Assistant to the Director	George E. Auman
Assistant to the Director	Clarence N. Coates
Senior Research Fellow	Dr. Churchill Eisenhart
Senior Research Fellow	Dr. Kurt E. Shuler
<b>101 OFFICE OF INDUSTRIAL SERVICES</b>	
Assistant Chief	Robert L. Stern
	Peter R. de Bruyn
<b>102 OFFICE OF PUBLIC INFORMATION</b>	
	A. Victor Gentilini
<b>105 OFFICE FOR ACADEMIC LIAISON</b>	
Associate Director for Academic Liaison	Dr. Shirleigh Silverman
<b>106 OFFICE OF ENGINEERING STANDARDS LIAISON AND ANALYSIS</b>	
	Dr. George S. Gordon
<b>107 OFFICE FOR PROGRAM DEVELOPMENT AND EVALUATION</b>	
<b>120 OFFICE OF ASSOCIATE DIRECTOR FOR ADMINISTRATION</b>	
Associate Director	Robert S. Walleigh
<b>121 ACCOUNTING</b>	
Deputy Chief	James P. Menzer
.01 Reports and Billing	Homer McIntyre
.03 Tabulation	Pearl E. Miller
.05 Payroll	Ralph A. Bryson
<b>.10 Cost and Payments Branch</b>	Kathryn L. Rock
.16 Accounts Payable	Henry L. Kenno
.18 Project Accounting	Matilda Udoff
	Robert F. Martin
<b>122 ADMINISTRATIVE SERVICES</b>	
Assistant Chief	George W. Knox
Fire Department	Karl L. Hafen
.01 Mail and Distribution	Charles O. Baker
.02 Special Services	Howard L. Sampson
.03 Janitorial Services	Walter J. Rabbitt
.04 Guard Services	Robert C. Howey
.05 Transportation Services	Capt. William J. Kane
.06 Security Office	Charles W. Anderson
	George W. Knox
<b>123 BUDGET AND MANAGEMENT</b>	
.01 Budget	Dr. James E. Skillington, Jr.
.02 Management Analysis	Eugene C. Denne
	Walter W. Weinstein
<b>124 INTERNAL AUDIT</b>	
	Harold F. Whittington

- 125 PERSONNEL**  
Assistant Chief  
.01 Board of Civil Service Examiners  
.02 Recruitment and Placement  
.03 Salary and Wage Administration  
.04 Employee Relations and Training  
.05 Operations and Procedures  
.06 Medical Office
- George R. Porter  
Henry C. Bothe  
Warren J. Barker  
Henry C. Bothe  
Charles V. Ramey  
Robert F. Bain  
Edith C. Lewis  
George H. L. Dillard, MD
- 126 PLANT**  
Assistant Chief  
.01 Steam-Chilled Water Generation  
.02 Electric Shop  
.03 Piping Shop  
.04 Construction Shop  
.06 Labor Services  
.07 Metal Shop  
.08 Air Conditioning and Refrigeration  
.09 Grounds
- M. Bernard Goetz (Acting)  
M. Bernard Goetz  
James S. Powers  
Robert W. Miller  
Gerard John Finan  
John A. King  
Roy B. Powell  
Donald I. Thompson  
Dominic J. Giampietro  
William R. Stevenson
- 127 SUPPLY**  
Deputy Chief  
.01 Storeroom Services  
.02 General Services  
.03 Procurement  
.04 Property Management
- George B. Kefover  
Fred H. Johncox  
Walter C. Bonner  
Norman H. Taylor (Acting)  
Richard A. Levi  
Harold G. Nicholas
- \*160 EXECUTIVE OFFICER FOR BOULDER SUPPORT**  
Executive Officer  
.10 Management Planning  
.20 Technical Information Office
- Samuel W. J. Welch  
Yvonne C. Stahnke (Acting)  
Jack R. Craddock
- \*161 ADMINISTRATIVE SERVICES**  
.30 Fiscal  
.40 Supply  
.50 Office Services  
.70 Drafting Services
- Barton F. Betts (Acting)  
Clarence Martella (Acting)  
Barton F. Betts  
Richard G. Bulgin  
Victor J. Pfannenstiel (Acting)
- \*162 SHOPS**  
.10 Instrument Shop 1  
.20 Instrument Shop 2  
.30 Instrument Shop 3  
.40 Welding-Sheet Metal  
.50 Grinding Shop  
.51 Electroplating Shop  
.60 Glass Blowing Shop
- Rodney S. Perrill  
Vernon E. Hill  
Donald E. Harriman  
Herman K. Stump  
James H. McCarron  
Henry C. Leistner  
Dale L. Smith  
H. L. Hoyt
- \*163 PLANT**  
.10 Design and Construction  
.20 Plant Services  
.30 Maintenance and Operations
- Edgar A. Yuzwiak  
William L. Arnold  
Roy J. Stadlbauer, Sr.  
Edward G. Clark

- 140 OFFICE OF ASSOCIATE DIRECTOR FOR TECHNICAL SUPPORT**  
 Associate Director Vacant  
 International Relations Dr. Ladislaus L. Marton
- 141 OFFICE OF TECHNICAL PUBLICATIONS**  
 Assistant Chief W. Reeves Tilley  
 .01 Information William K. Gautier  
 .02 Editorial Robert T. Cook  
 .03 Publications William K. Gautier  
 .04 Photographic Services John E. Carpenter  
 .05 Graphic Arts Warren P. Richardson  
 Conrad F. Peters
- 142 RESEARCH INFORMATION**  
 .01 Library Vacant  
 Sarah Ann Jones
- 143 OFFICE OF RADIATION SAFETY**  
 .01 Health Physics Dr. Abraham Schwebel (Acting)  
 Dr. Abraham Schwebel
- 145 INSTRUMENT SHOPS**  
 Assistant Chief Frank P. Brown  
 .01 Instrument Shop #1 Winfield L. Drissel  
 .02 Instrument Shop #2 John R. Hettenhouser  
 .03 Instrument Shop #3 Walter A. Koepper  
 .04 Instrument Shop #4 Charles E. Taylor  
 .05 Instrument Shop #5 Philip Pfaff, Jr.  
 .06 Glassblowing John R. Pidgeon  
 .07 Welding and Sheet Metal Shop Enrico Deleonibus  
 .08 Optical Shop Harold E. Brown  
 .09 Tool Crib Stanley W. Gerner  
 .10 Electroplating Lewis H. Brigham  
 Frank P. Brown (Acting)
- 146 MEASUREMENT ENGINEERING**  
 .01 Electronic Instrumentation G. Franklin Montgomery  
 .02 Electronic Optical Development Robert J. Carpenter  
 .03 Microwave and Mechanical Instrumentation M. Leighton Greenough  
 Robert O. Stone
- 200 INSTITUTE FOR BASIC STANDARDS**  
 Director Dr. Robert D. Huntoon  
 Deputy Director Dr. Merrill B. Wallenstein  
 Deputy Director for Radio Standards Dr. Helmut M. Altschuler (Acting)  
 Associate Director, Measurement Services William A. Wildhack
- 201 OFFICE OF STANDARD REFERENCE DATA**  
 Chemical Kinetics Dr. Edward L. Brady  
 Colloid and Surface Chemistry Dr. Stephen A. Rossmassler  
 Data File Dr. Howard J. White, Jr.  
 Information Services Dr. Alfred Weissberg  
 Information Systems Design Dr. Herman M. Weisman  
 Nuclear Data Dr. Franz L. Alt  
 Thermodynamics and Transport Data Dr. David Goldman  
 Dr. Everett R. Johnson

- 205 APPLIED MATHEMATICS**  
 Deputy Chief for Program Planning  
 Consultant  
 .01 Numerical Analysis  
 .03 Statistical Engineering  
 .04 Mathematical Physics  
 .05 Operations Research
- 211 ELECTRICITY**  
 .01 Resistance and Reactance  
 .02 Electrochemistry  
 .03 Electrical Instruments  
 .04 Magnetic Measurements  
 .06 High Voltage  
 .07 Absolute Electrical Measurements
- 212 METROLOGY**  
 Consultant  
 Assistant Chief  
**.10 Optical Metrology Branch**  
 .11 Photometry  
 .13 Image Optics and Photography  
 .14 Colorimetry and Spectrophotometry  
 .15 Radiometry  
**.20 Length Metrology Branch**  
 .21 Length  
 .22 Engineering Metrology  
**.30 Mass and Volume Branch**  
 .31 Mass and Volume
- 213 MECHANICS**  
 Consultant  
 .01 Sound  
 .04 Engineering Mechanics  
 .05 Rheology  
**.20 Mechanical Measurements Branch**  
 .21 Pressure Measurements  
 .22 Vacuum Measurements  
 .23 Vibration Measurements  
 .24 Humidity Measurements  
**.30 Fluid Mechanics Branch**  
 .31 Fluid Meters  
 .32 Hydraulics  
 .33 Aerodynamics
- 221 HEAT**  
 Assistant Chief for Thermodynamics  
 Assistant Chief for Thermometry  
 .02 Heat Measurements  
 .03 Cryogenic Physics  
 .04 Equation of State  
 .05 Statistical Physics  
 .06 Molecular Energy Levels  
 .11 Temperature  
 .12 Radiation Thermometry
- Dr. Edward W. Cannon  
 Dr. Alan J. Goldman  
 Dr. Hansjorg Oser  
 Dr. Morris Newman  
 Joseph M. Cameron  
 Dr. Hansjorg Oser (Acting)  
 Dr. Alan J. Goldman
- Dr. Chester H. Page  
 Chester Peterson  
 Dr. Walter J. Hamer  
 Francis L. Hermach  
 Irvin L. Cooter  
 Dr. F. Ralph Kotter  
 Dr. Forest K. Harris
- Alvin G. McNish  
 Dr. Francis E. Washer  
 Dr. Deane B. Judd  
 Louis E. Barbrrow  
 Charles A. Douglas  
 Calvin S. McCamy  
 Isadore Nimeroff  
 George A. Hornbeck  
 Theodore R. Young  
 Theodore R. Young  
 Arthur G. Strang  
 Paul E. Pontius  
 Paul E. Pontius
- Bruce L. Wilson  
 Dr. Daniel P. Johnson  
 Martin Greenspan (Acting)  
 Lafayette K. Irwin  
 Dr. Robert S. Marvin  
 Edward C. Lloyd  
 Edward C. Lloyd (Acting)  
 Stanley Ruthberg  
 Seymour Edelman  
 Arnold Wexler  
 Dr. Galen B. Schuberger  
 Fillmer W. Ruegg  
 Dr. Gershon Kulin  
 Dr. Galen B. Schubauer (Acting)
- Dr. Ralph P. Hudson  
 Dr. Charles W. Beckett  
 James F. Swindells  
 Dr. Defoe C. Ginnings  
 Dr. Ralph P. Hudson (Acting)  
 Joseph Hilsenrath  
 Dr. Melville S. Green  
 Dr. Arnold M. Bass  
 Dr. Harmon H. Plumb  
 Dr. Henry J. Kostkowski

- 222 ATOMIC PHYSICS**  
 .01 Spectroscopy  
 .02 Infrared and Microwave Spectroscopy  
 .03 Far Ultraviolet Physics  
 .05 Electron Physics  
 .06 Atomic Physics  
 .07 Plasma Spectroscopy
- 223 PHYSICAL CHEMISTRY**  
 Consultant  
 .11 Thermochemistry  
 .21 Surface Chemistry  
 .51 Elementary Processes  
 .52 Mass Spectrometry  
 .53 Photo Chemistry  
 .54 Radiation Chemistry
- \*224 LABORATORY ASTROPHYSICS**  
 Deputy Chief
- 231 RADIATION PHYSICS**  
 .01 Radiation Theory  
**.10 Radiological Physics Branch**  
 .11 X-ray Physics  
 .12 Dosimetry  
 .13 X-ray Standards  
**.20 Nuclear Physics Branch**  
 .21 Radioactivity  
 .22 Neutron Physics  
 .23 Photonuclear Physics  
 .24 Nuclear Spectroscopy  
**.30 Accelerator Branch**  
 .31 Accelerator Engineering  
 .32 Radiation Physics Instrumentation  
 .33 Accelerator Physics
- \*250 RADIO STANDARDS LABORATORY**  
 Scientific Consultant
- \*251 RADIO STANDARDS PHYSICS**  
 Assistant Chief  
 .01 Frequency-Time Dissemination Research  
 .02 Frequency-Time Broadcast Services  
 .03 Radio and Microwave Materials  
 .04 Atomic Frequency and Time Standards  
 .05 Quantum Electronics  
 .06 Radio Plasma
- Dr. Karl G. Kessler  
 Dr. William C. Martin, Jr.  
 Dr. David R. Lide, Jr.  
 Dr. Robert P. Madden  
 Dr. John A. Simpson  
 Dr. Harold S. Boyne  
 Dr. Wolfgang L. Wiese
- Dr. Robert E. Ferguson  
 Edward J. Prosen  
 Donald D. Wagman  
 Dr. Ralph Klein  
 Dr. David Garvin  
 Dr. Harry M. Rosenstock  
 Dr. James R. McNesby  
 Dr. Pierre J. Ausloss
- Dr. Lewis M. Branscomb  
 Dr. Stephen J. Smith
- Dr. Randall S. Caswell (Acting)  
 Dr. Martin J. Berger  
 Dr. Joseph W. Motz  
 Dr. Joseph W. Motz  
 Dr. Scott W. Smith  
 Dr. Ben Petree (Acting)  
 Vacant  
 Dr. Wilfrid B. Mann  
 Dr. Randall S. Caswell  
 Dr. Everett G. Fuller  
 Dr. Raymond W. Hayward  
 Dr. James E. Leiss  
 Dr. James E. Leiss  
 Louis Costrell  
 Dr. Samuel Penner
- Dr. Helmut M. Altschuler (Acting)  
 Dr. David M. Kerns
- Dr. L. Yardley Beers  
 Dr. George E. Hudson  
 Alvin H. Morgan  
 David H. Andrews  
 John L. Dalke  
 James A. Barnes (Acting)  
 Dr. Donald A. Jennings (Acting)  
 Dr. Karl B. Persson



- \*252 RADIO STANDARDS ENGINEERING**  
 Consultant  
 Consultant  
 .21 HF Calibration Services  
 .22 HF Electrical Standards  
 .23 HF Impedance Standards  
 .31 Microwave Calibration Services  
 .32 Microwave Circuit Standards  
 .42 Electromagnetic Fields Standards
- Dr. Charles M. Allred (Acting)  
 Robert W. Beatty  
 Myron C. Selby  
 Dr. Karl R. Wendt  
 Paul A. Hudson (Acting)  
 Alfred E. Hess (Acting)  
 Roy E. Larson  
 Dr. Maurice B. Hall  
 Dr. Ramon C. Baird
- 300 INSTITUTE FOR MATERIALS RESEARCH**  
 Director  
 .10 **Materials Evaluation Laboratory**  
 Consultant on Leather  
 Consultant on Mathematical Statistics  
 .11 Materials Evaluation and Testing  
 .12 Procurement Systems  
 .13 Evaluation Criteria  
 .14 Performance Research
- Dr. Gordon K. Teal  
 Dr. Robert B. Hobbs  
 Dr. Joseph R. Kanagy  
 Dr. John Mandel  
 Dr. Sanford B. Newman  
 Donald G. Fletcher  
 Dr. Robert D. Stiehler  
 William K. Wilson
- 302 OFFICE OF STANDARD REFERENCE MATERIALS**  
 Inorganic Standards Coordinator  
 Metal Standards Coordinator  
 Organic Standards Coordinator
- Dr. W. Wayne Meinke  
 John L. Hague  
 Robert E. Michaelis  
 Thomas W. Mears
- 310 ANALYTICAL CHEMISTRY**  
 Assistant Chief  
 Consultant  
 .01 Radiochemical Analysis  
 .02 Spectrochemical Analysis  
 .03 Electrochemical Analysis  
 .04 Analytical Coordination Chemistry  
 .05 Microchemical Analysis  
 .06 Analytical Mass Spectrometry  
 .07 Organic Chemistry  
 .08 Activation Analysis  
 .09 Separation and Purification
- Dr. W. Wayne Meinke  
 Dr. Roger G. Bates  
 Dr. Charles P. Saylor  
 Dr. James R. DeVoe  
 Bourdon F. Scribner  
 Dr. Roger G. Bates  
 Dr. Oscar Menis  
 Dr. John K. Taylor  
 William R. Shields  
 Dr. Horace S. Isbell  
 Dr. James R. DeVoe  
 Dr. David H. Freeman
- 311 POLYMERS**  
 Deputy Chief  
 Consultant  
 Consultant on Polymers  
 Consultant on Rubber  
 .01 Polymer Dielectrics  
 .02 Polymer Chemistry  
 .03 Polymer Physics  
 .04 Molecular Properties  
 .05 Dental Research  
 .06 Polymer Characterization
- Dr. John D. Hoffman  
 Dr. Norman P. Bekkedahl  
 Dr. John I. Lauritzen, Jr.  
 Dr. Samuel G. Weissberg  
 Dr. Lawrence A. Wood  
 Dr. Martin G. Broadhurst  
 Dr. Leo A. Wall  
 Dr. Elio Passaglia  
 Dr. Cornelis A. J. Hoeve  
 William T. Sweeney  
 Dr. Emanuel Horowitz

**312 METALLURGY**

- Consultant
- .01 Engineering Metallurgy
- .02 Alloy Physics
- .03 Lattice Defects and Microstructures
- .04 Corrosion
- .05 Metal Physics
- .06 Electrolysis and Metal Deposition
- .07 Crystallization of Metals

Dr. Lawrence M. Kushner  
George A. Ellinger  
Dr. Melvin R. Meyerson  
Dr. Lawrence H. Bennett  
Dr. A. William Ruff, Jr.  
Dr. Jerome Kruger  
Dr. John A. Simmons  
Dr. Abner Brenner  
Dr. Robert L. Parker

**313 INORGANIC MATERIALS**

- Consultant
- Consultant
- Consultant
- Consultant
- Consultant
- Consultant
- .01 Inorganic Chemistry
- .02 Glass
- .03 High Temperature Chemistry
- .04 Crystal Chemistry
- .05 Physical Properties
- .06 Crystallography
- .07 Solid State Physics

Dr. Ernest Ambler  
Dr. Marvin L. Cohen  
Dr. Gilbert Gordon  
Clarence H. Hahner  
Dr. Ellis R. Lippincott  
Dr. Howard F. McMurdie  
Dr. James M. Stewart  
Dr. Thomas D. Coyle  
Dr. Wolfgang Haller  
Dr. William S. Horton  
H. Steffen Peiser  
Dr. John B. Wachtman, Jr.  
Dr. Stanley Block  
Dr. Hans P. R. Frederikse

**314 REACTOR RADIATIONS**

Dr. Carl O. Muehlhause

**\*315 CRYOGENICS**

- Assistant Chief
- Consultant
- .01 Cryogenic Technical Services
- .02 Cryogenic Data Center
- .03 Cryogenic Properties of Solids
- .04 Properties of Cryogenic Fluids
- .05 Cryogenic Systems
- .06 Cryogenic Metrology
- .07 Cryogenic Fluid Transport Processes

Bascom W. Birmingham  
Dr. R. Joseph Corruccini  
Alan F. Schmidt  
William A. Wilson  
Victor J. Johnson  
Dr. Richard H. Kropschot  
Dr. R. Joseph Corruccini  
Dudley B. Chelton  
Dr. Thomas M. Flynn  
Raymond V. Smith

**400 INSTITUTE FOR APPLIED TECHNOLOGY**

- Director
- Deputy Director

John P. Eberhard  
Dr. Lawrence M. Kushner

**402 ENGINEERING STANDARDS**

Malcolm W. Jensen

**403 OFFICE OF ENGINEERING STANDARDS SERVICES**

- .01 Product Standards
- .02 Engineering Standards Information

Donald R. MacKay (Acting)  
Donald R. MacKay  
William J. Slattery

**404 OFFICE OF WEIGHTS AND MEASURES**

Malcolm W. Jensen

- 406 OFFICE OF INVENTION AND INNOVATION**  
 .01 Innovation Studies and Analyses Daniel V. DeSimone  
 .02 Invention Programs Daniel V. DeSimone (Acting)  
 Leonard S. Hardland
- 410 CLEARINGHOUSE FOR FEDERAL SCIENTIFIC AND TECHNICAL INFORMATION**  
 Director Bernard M. Fry  
 Deputy Director Herbert Sauter  
 .10 Document Distribution and Reproduction Branch Paul W. Larsen  
 .30 Automated Systems and Services Branch Clifford R. Paulson  
 .40 Customer Relations Branch James E. Wheat  
 .60 Administrative Services Branch Joseph G. Coyne  
 .70 Joint Publications Research Service Edward A. Thibault  
 .80 Document Processing Branch George K. Taylor
- 421 BUILDING RESEARCH**  
 Deputy Chief Dr. Allan A. Bates  
 .01 Structures Paul R. Achenbach  
 .02 Fire Research Dr. Edward O. Pfrang  
 .03 Environmental Engineering Dr. Alexander F. Robertson  
 .04 Materials and Composites Henry E. Robinson  
 .05 Codes and Standards Dr. William W. Walton  
 Dr. Bruce E. Foster
- 425 ELECTRONIC INSTRUMENTATION**  
 .01 Engineering Electronics Myron G. Domsitz  
 .02 Electron Devices Gustave Shapiro  
 .05 Basic Instrumentation Charles P. Marsden  
 Joshua Stern
- 427 TEXTILE AND APPAREL TECHNOLOGY CENTER**  
 Dr. F. Cecil Brenner
- 431 TECHNICAL ANALYSIS**  
 Benefit-Cost Studies Dr. W. Edward Cushen  
 Corridor Simulation Dr. Reginald V. Hobbah  
 Economic Benefit Studies Abraham E. Karp  
 Economic Systems Studies-Models Dr. Joseph D. Crumlish  
 Engineering Studies Marshall K. Wood  
 Innovation Studies Cleveland Hopkins  
 Dr. George Suzuki
- 450 CENTER FOR COMPUTER SCIENCES AND TECHNOLOGY**  
 Director John P. Eberhard (Acting)  
 Assistant to Director W. Howard Gammon
- 451 OFFICE FOR INFORMATION STANDARDS**  
 Joseph H. Wegstein (Acting)
- 452 TECHNICAL INFORMATION EXCHANGE**  
 Margaret R. Fox (Acting)
- 453 COMPUTER SERVICES**  
 Irvin V. Voltin

454	MANAGEMENT APPLICATIONS PLANNING	W. Howard Gammon (Acting)
455	SYSTEMS RESEARCH AND DEVELOPMENT	Ethel C. Marden (Acting)
456	INFORMATION PROCESSING TECHNOLOGY	James P. Nigro (Acting)
457	INFORMATION SCIENCES	Mary Elizabeth Stevens (Acting)

\* Laboratories located in in Boulder, Colorado.

#### FIELD STATIONS

Visual Landing Aids Laboratory, Arcata, CA  
 U.S. Joint Publications Research Service, San Francisco, CA  
 Master Railway Track Scale Depot, Clearing, IL  
 Radio Station WWV, Greenbelt, MD  
 U.S. Joint Publications Research Service, New York, NY  
 Ionosphere Research Station, Wallops Island, VA  
 Inorganic Building Materials Section Laboratory, Seattle, WA  
 Standard Frequency Stations WWVB/WWVL, Fort Collins, CO  
 Radio Propagation and Standard Frequency Station WWVH, Puunene, Maui, HA  
 Standard Frequency Station WWV, Greenbelt, MD

June 14, 1968

<b>100 OFFICE OF THE DIRECTOR</b>	
Director	Dr. Allen V. Astin
Deputy Director	Dr. Irl C. Schoonover
Assistant to the Director	George E. Auman
Assistant to the Director	Clarence N. Coates
Assistant to the Director for Metric Study	Alvin G. McNish
Senior Research Fellow	Dr. Churchill Eisenhart
<b>101 OFFICE OF INDUSTRIAL SERVICES</b>	Dr. George S. Gordon
<b>102 OFFICE OF PUBLIC INFORMATION</b>	A. Victor Gentilini
<b>105 OFFICE OF ACADEMIC LIAISON</b>	
Associate Director for Academic Liaison	Dr. Shirleigh Silverman
<b>106 OFFICE OF ENGINEERING STANDARDS LIAISON</b>	Dr. A. Allan Bates
<b>107 OFFICE OF PROGRAM DEVELOPMENT AND EVALUATION</b>	Dr. Robert D. Huntoon
<b>120 OFFICE OF ASSOCIATE DIRECTOR FOR ADMINISTRATION</b>	
Associate Director	Robert S. Walleigh
Deputy Associate Director for Administration	Paul H. Schrader
<b>121 Accounting</b>	James P. Menzer
Deputy Chief	Homer McIntyre
.01 Reports and Billing	Pearl E. Miller
.03 Tabulation	Ralph A. Bryson
.05 Payroll	Katheryn L. Rock
<b>.10 Cost and Payments Branch</b>	Henry L. Kenno
.16 Accounts Payable	Matilda Udoff
.18 Project Accounting	Robert F. Martin
<b>122 ADMINISTRATIVE SERVICES</b>	George W. Knox
Assistant Chief	Karl L. Hafen
Fire Protection Service	Charles O. Baker
.01 Mail and Distribution	Howard L. Sampson
.02 Special Services	Walter J. Rabbitt
.03 Janitorial Services	Robert E. Roberts
.04 Guard Services	Capt. William J. Kane
.05 Transportation Services	Charles W. Anderson
.06 Security Office	George W. Knox
<b>123 BUDGET</b>	Dr. James E. Skillington, Jr.
Deputy Chief	Eugene C. Denne
<b>125 PERSONNEL</b>	George R. Porter
Assistant Chief	Henry C. Bothe
.02 Recruitment and Placement	Henry C. Bothe
.03 Salary and Wage Administration	Roy V. Stapleton
.04 Employee Development and Relations	Robert F. Bain
.05 Operations and Procedures	Vacant
.06 Medical Office	George H. L. Dillard, MD

- 126 PLANT**  
 Assistant Chief  
 .01 Steam-Chilled Water Generation  
 .02 Electric Shop  
 .03 Piping Shop  
 .04 Construction Shop  
 .06 Labor Services  
 .07 Metal Shop  
 .08 Air Conditioning and Refrigeration  
 .09 Grounds
- 127 SUPPLY**  
 Deputy Chief  
 .01 Storeroom Services  
 .02 Travel Office  
 .03 Procurement  
 .04 Property Management  
 .05 Telephone Office
- 128 MANAGEMENT AND ORGANIZATION**  
 Consultive Services  
 Records Management Officer  
 Administrative Issuances  
 Management Surveys  
 Management Systems
- 140 OFFICE OF ASSOCIATE DIRECTOR FOR TECHNICAL SUPPORT**  
 Associate Director  
 International Relations
- 141 OFFICE OF TECHNICAL INFORMATION AND PUBLICATIONS**  
 Assistant Chief  
 .01 Special Activities  
 .02 Editorial  
 .03 Publications  
 .04 Photographic Services  
 .05 Graphic Arts  
 .06 Computer Assisted Printing
- 142 LIBRARY**
- 145 INSTRUMENT SHOPS**  
 Assistant Chief  
 .01 Instrument Shop #1  
 .02 Instrument Shop #2  
 .03 Instrument Shop #3  
 .04 Instrument Shop #4  
 .05 Instrument Shop #5  
 .06 Glassblowing  
 .07 Welding and Sheet Metal Shop  
 .08 Optical Shop  
 .09 Tool Crib  
 .10 Electroplating
- Hylton Graham  
 M. Bernard Goetz  
 James S. Powers  
 Robert W. Miller  
 Gerard J. Finan  
 John A. King  
 Roy B. Powell  
 Donald I. Thompson  
 Dominic J. Giampietro  
 William R. Stevenson
- George B. Kefover  
 Norman H. Taylor  
 Walter C. Bonner  
 Mary H. Jenner  
 Frank Tallerico (Acting)  
 Robert E. Wilson  
 Pat Hafen
- John T. Hall  
 Wayne B. Davis  
 Walter W. Weinstein  
 Elizabeth M. Henley  
 Iris M. Lloyd  
 Joseph C. Aubele
- Vacant  
 Dr. Ladislaus L. Marton
- W. Reeves Tilley  
 William K. Gautier  
 Robert T. Cook  
 William K. Gautier  
 John E. Carpenter  
 Warren P. Richardson  
 Conrad F. Peters  
 Rubin Wagner
- Dr. Elizabeth L. Tate
- Frank P. Brown  
 Winfield L. Drissel  
 Stanley W. Gerner (Acting)  
 Walter A. Koepper  
 Charles E. Taylor  
 Phillip Pfaff, Jr.  
 John R. Pidgeon  
 Enrico Deleonibus  
 Harold E. Brown  
 Stanley W. Gerner  
 Herbert Robinson (Acting)  
 Frank P. Brown (Acting)

- 146 MEASUREMENT ENGINEERING**  
 .01 Electronic Instrumentation  
 .02 Electronic Optical Development  
 .03 Microwave and Mechanical Instrumentation
- 200 INSTITUTE FOR BASIC STANDARDS**  
 Director
- 201 OFFICE OF STANDARD REFERENCE DATA**  
 Atomic and Molecular Data  
 Chemical Kinetics  
 Colloid and Surface Chemistry  
 Information Services  
 Information Systems Design  
 Mechanical Properties  
 Nuclear Data  
 Solid State Properties  
 Thermodynamics and Transport Data
- 205 APPLIED MATHEMATICS**  
 .01 Numerical Analysis  
 .02 Operations Research  
 .03 Statistical Engineering  
 .04 Systems Dynamics
- 211 ELECTRICITY**  
 .01 Resistance and Reactance  
 .02 Electrochemistry  
 .03 Electrical Instruments  
 .06 High Voltage  
 .07 Absolute Electrical Measurements
- 212 METROLOGY**  
 Assistant Chief  
**.10 Optics Metrology Branch**  
 .11 Photometry  
 .13 Image Optics and Photography  
 .14 Colorimetry and Spectrophotometry  
**.20 Length Metrology Branch**  
 .21 Length  
 .22 Engineering Metrology  
**.30 Mass and Volume Branch**  
 .31 Mass and Volume
- 213 MECHANICS**  
 Consultant  
 .01 Sound  
 .04 Engineering Mechanics  
 .05 Rheology  
**.20 Mechanical Measurements Branch**  
 .21 Pressure Measurements  
 .22 Vacuum Measurements  
 .23 Vibration Measurements  
 .24 Humidity Measurements  
**.30 Fluid Mechanics Branch**  
 .31 Fluid Meters  
 .32 Hydraulics  
 .33 Aerodynamics
- G. Franklin Montgomery  
 Robert J. Carpenter  
 M. Leighton Greenough  
 Robert O. Stone
- Dr. Ernest Ambler
- Dr. Edward L. Brady  
 Dr. Stephen A. Rossmassler  
 Dr. Lewis H. Gevantman  
 Dr. Howard J. White, Jr.  
 Dr. Herman M. Weisman  
 Joseph Hilsenrath  
 Dr. Lewis H. Gevantman  
 Dr. David Goldman  
 Dr. Lewis H. Gevantman  
 Dr. Howard J. White, Jr.
- Dr. Edward W. Cannon  
 Dr. Morris Newman  
 Dr. Alan J. Goldman  
 Joseph M. Cameron  
 Dr. Hansjorg Oser
- Dr. Chester H. Page  
 Chester Peterson  
 Dr. Walter J. Hamer  
 Francis L. Hermach  
 Dr. F. Ralph Kotter  
 Dr. Forest K. Harris
- Theodore R. Young (Acting)  
 Dr. Deane B. Judd  
 Louis E. Barbrow  
 Charles A. Douglas  
 Calvin S. McCamy  
 Isadore Nimeroff  
 Theodore R. Young  
 John S. Beers (Acting)  
 Arthur G. Strang  
 Paul E. Pontius  
 Paul E. Pontius
- Edward C. Lloyd (Acting)  
 Dr. Daniel P. Johnson  
 Martin Greenspan  
 Lafayette K. Irwin  
 Dr. Robert S. Marvin  
 Edward C. Lloyd  
 Edward C. Lloyd (Acting)  
 Stanley Ruthberg  
 Roscoe L. Bloss  
 Arnold Wexler  
 Vacant  
 Fillmer W. Ruegg  
 Dr. Gershon Kulin  
 Vacant

- 221 HEAT**  
 Assistant Chief for Thermodynamics  
 .02 Heat Measurements  
 .03 Cryogenic Physics  
 .04 Equation of State  
 .05 Statistical Physics  
 .06 Molecular Energy Levels  
 .11 Temperature  
 .12 Radiation Thermometry
- 222 ATOMIC PHYSICS**  
 .01 Spectroscopy  
 .02 Infrared and Microwave Spectroscopy  
 .03 Far Ultraviolet Physics  
 .05 Electron Physics  
 .06 Atomic Physics  
 .07 Plasma Spectroscopy
- \*270 OFFICE OF DEPUTY DIRECTOR, IBS/BOULDER**  
 Deputy Director  
 .01 Office of Program Development and Evaluation  
 .02 Office of Management Systems
- \*271 RADIO STANDARDS PHYSICS**  
 Consultant  
 Consultant  
 .01 Solid State Electronics  
 .05 Quantum Electronics  
 .06 Plasma Physics
- \*272 RADIO STANDARDS ENGINEERING**  
 Consultant  
 Consultant  
 .21 Calibration Services  
 .22 HF Electrical Standards  
 .23 HF Impedance Standards  
 .31 Microwave Calibration Services  
 .32 Microwave Circuit Standards  
 .42 Electromagnetic Fields Standards
- \*273 TIME AND FREQUENCY**  
 Assistant Chief  
 Consultant  
 Consultant  
 Consultant  
 .01 Frequency-Time Dissemination Research  
 .02 Frequency-Time Broadcast Services  
 .04 Atomic Frequency-Time Standards
- \*274 LABORATORY ASTROPHYSICS**  
 Deputy Chief
- Dr. Ralph P. Hudson  
 Dr. Charles W. Beckett  
 Dr. Defoe C. Ginnings  
 Dr. James F. Schooley (Acting)  
 Dr. Max Klein  
 Dr. Melville S. Green  
 Dr. Arnold M. Bass  
 Dr. Harmon H. Plumb  
 Dr. Henry J. Kostkowski
- Dr. Karl G. Kessler  
 Dr. William C. Martin, Jr.  
 Dr. David R. Lide, Jr.  
 Dr. Robert P. Madden  
 Dr. John A. Simpson  
 Dr. Richard D. Deslattes  
 Dr. Wolfgang L. Wiese
- Bascom W. Birmingham (Acting)  
 Dr. Thomas M. Flynn  
 Roy W. Stockwell, Jr.
- Dr. Harold S. Boyne (Acting)  
 Dr. L. Yardley Beers  
 T. W. Russell  
 Dr. Robert J. Mahler  
 Dr. Donald A. Jennings  
 Dr. Karl B. Persson
- Dr. Helmut M. Altschuler  
 Robert W. Beatty  
 Myron C. Selby  
 Dr. Karl R. Wendt  
 Charles M. Allred  
 Robert C. Powell  
 Cletus A. Hoer (Acting)  
 Roy E. Larson  
 Dr. Maurice B. Hall  
 Dr. Ramon C. Baird
- Dr. James A. Barnes  
 Roger E. Beehler  
 R. Lowell Fey  
 Dr. George E. Hudson  
 Alvin H. Morgan  
 James L. Jespersen  
 Peter P. Viezbicke (Acting)  
 Dr. Donald W. Halford
- Dr. Lewis M. Branscomb  
 Dr. Stephen J. Smith



- \*275 CRYOGENICS**  
 Consultant  
 .01 Cryogenic Technical Services  
 .02 Cryogenic Data Center  
 .03 Cryogenic Properties of Solids  
 .04 Properties of Cryogenic Fluids  
 .05 Cryogenic Systems  
 .06 Cryogenic Metrology  
 .07 Cryogenic Fluid Transport Processes
- Dudley B. Chelton (Acting)  
 Alan F. Schmidt  
 William A. Wilson  
 Victor J. Johnson  
 Dr. Richard H. Kropschot  
 Dwain E. Diller (Acting)  
 R. W. Arnett (Acting)  
 Douglas B. Mann  
 Raymond V. Smith
- \*281 ADMINISTRATIVE SERVICES**  
 .01 Supply  
 .02 Office Services  
 .03 Drafting Services
- Barton F. Betts  
 J. S. Roettenbacher  
 Richard G. Bulgin  
 Victor J. Pfannenstiel
- \*282 INSTRUMENT SHOPS**  
 Consultant-Engineering  
 .01 Instrument Shop 1  
 .02 Instrument Shop 2  
 .03 Welding-Sheet Metal  
 .04 Glass Blowing Shop
- Rodney S. Perrill  
 Jay N. Edmondson  
 Vernon E. Hill  
 Henry C. Leistner  
 James H. McCarron  
 H. L. Hoyt
- \*283 PLANT**  
 Deputy Chief  
 .01 Construction-Maintenance  
 .02 Special Services  
 .03 Custodial Services
- Edgar A. Yuzwiak  
 George M. Musick, Jr.  
 Robert W. Eddy  
 William D. Hitchcock  
 Wilmer L. Schweikert
- 300 INSTITUTE FOR MATERIALS RESEARCH**  
 Director  
 Deputy Director  
 Assistant to the Director
- Dr. John D. Hoffman  
 Dr. Howard E. Sorrows  
 Dr. Emanuel Horowitz
- 302 OFFICE OF STANDARD REFERENCE MATERIALS**  
 Deputy Chief  
 Inorganic Standards Coordinator  
 Metal Standards Coordinator  
 Organic Standards Coordinator
- Dr. W. Wayne Meinke  
 Joseph P. Cali  
 John L. Hague  
 Robert E. Michaelis  
 Thomas W. Mears
- 310 ANALYTICAL CHEMISTRY**  
 Consultant  
 .01 Radiochemical Analysis  
 .02 Spectrochemical Analysis  
 .03 Electrochemical Analysis  
 .04 Analytical Coordination Chemistry  
 .05 Microchemical Analysis  
 .06 Analytical Mass Spectrometry  
 .07 Organic Chemistry  
 .08 Activation Analysis  
 .09 Separation and Purification
- Dr. W. Wayne Meinke  
 Dr. Charles P. Saylor  
 Dr. James R. DeVoe  
 Bourdon F. Scribner  
 Dr. Roger G. Bates  
 Dr. Oscar Menis  
 Dr. John K. Taylor  
 William R. Shields  
 Dr. Robert Schaffer  
 Dr. Philip D. LaFleur  
 Dr. David H. Freeman

- 311 POLYMERS**  
 Consultant on Polymers  
 Consultant on Rubber  
 Consultant for Dental Materials  
 .01 Polymer Dielectrics  
 .02 Polymer Chemistry  
 .03 Polymer Crystal Physics  
 .04 Molecular Properties  
 .05 Dental Research  
 .06 Polymer Characterization  
 .07 Polymer Interfaces  
 .08 Thermophysical Properties
- 312 METALLURGY**  
 .01 Engineering Metallurgy  
 .02 Alloy Physics  
 .03 Lattice Defects and Microstructures  
 .04 Corrosion  
 .05 Metal Physics  
 .06 Electrolysis and Metal Deposition  
 .07 Crystallization of Metals
- 313 INORGANIC MATERIALS**  
 Consultant  
 Consultant  
 Consultant  
 Consultant  
 Consultant  
 Consultant  
 Consultant  
 .01 Inorganic Chemistry  
 .02 Inorganic Glass  
 .03 High Temperature Chemistry  
 .05 Physical Properties  
 .06 Crystallography  
 .07 Solid State Physics
- 316 PHYSICAL CHEMISTRY**  
 Consultant  
 .11 Thermochemistry  
 .21 Surface Chemistry  
 .51 Elementary Processes  
 .52 Mass Spectrometry  
 .53 Photo Chemistry  
 .54 Radiation Chemistry
- 400 INSTITUTE FOR APPLIED TECHNOLOGY**  
 Director
- 402 ENGINEERING STANDARDS**
- Dr. R. R. Stromberg (Acting)  
 Dr. Samuel G. Weissberg  
 Dr. Lawrence A. Wood  
 William T. Sweeney  
 Dr. Martin G. Broadhurst  
 Dr. Leo A. Wall  
 Dr. Ronald K. Eby  
 Dr. Cornelis A. J. Hoeve  
 George R. Dickson  
 Dr. Cornelis A. J. Hoeve (Acting)  
 Dr. Robert R. Stromberg  
 Dr. Alden B. Bestul
- Dr. Elio Passalia  
 Dr. Melvin R. Meyerson  
 Dr. Lawrence H. Bennett  
 Dr. A. William Ruff, Jr.  
 Dr. Jerome Kruger  
 Dr. John R. Manning  
 Dr. Abner Brenner  
 Dr. Robert L. Parker
- Dr. John B. Wachtman, Jr. (Acting)  
 Dr. Arthur I. Bienenstock  
 Dr. M. Cardona  
 Dr. Gilbert Gordon  
 Dr. Y. Haven  
 Dr. Ellis R. Lippincott  
 Dr. Howard F. McMurdie  
 H. Steffen Peiser  
 Dr. James M. Stewart  
 Dr. Thomas D. Coyle  
 Dr. Wolfgang Haller  
 Dr. William S. Horton  
 Dr. Sheldon H. Wiederhorn  
 Dr. Stanley Block  
 Dr. Hans P. R. Frederikse
- Dr. James R. McNesby (Acting)  
 Edward J. Prosen  
 Dr. George T. Armstrong (Acting)  
 Dr. Ralph Klein  
 Dr. David Garvin  
 Dr. Henry M. Rosenstock  
 Dr. James R. McNesby  
 Dr. Pierre J. Ausloss
- Dr. Lawrence M. Kushner
- Malcolm W. Jensen

- 403 OFFICE OF ENGINEERING STANDARDS SERVICES**  
.02 Standards Information  
.03 Mandatory Standards  
Donald R. MacKay  
William J. Slattery (Acting)  
Donald R. MacKay (Acting)
- 404 OFFICE OF WEIGHTS AND MEASURES**  
Assistant Chief  
Malcolm W. Jensen  
Harold F. Wollin
- 406 OFFICE OF INVENTION AND INNOVATION**  
.01 Innovation Studies Program  
.02 Invention Programs  
.03 Engineering Education Program  
Daniel V. DeSimone  
Joseph D. Crumlish  
Leonard S. Hardland  
John M. Tascher
- 408 OFFICE OF VEHICLE SYSTEMS RESEARCH**  
Deputy Chief  
.01 Tire Systems  
.02 Occupant Restraint Systems  
.03 Braking Systems  
Paul J. Brown  
Dr. F. Cecil Brenner (Acting)  
Dr. F. Cecil Brenner  
Richard W. Armstrong  
Robert J. Forthofer
- 410 CLEARINGHOUSE FOR FEDERAL SCIENTIFIC AND TECHNICAL INFORMATION**  
Director  
Deputy Director  
.10 Document distribution and Reproduction Branch  
.30 Automated Systems and Services Branch  
.60 Administrative Operations Branch  
.70 Joint Publications Research Service  
.80 Document Processing Branch  
Hubert E. Sauter  
Peter F. Urbach  
Alvin W. Alexander  
Mitchell A. Krasny  
Joseph G. Coyne  
Gustav Blackett  
George K. Kudravetz (Acting)
- 411 PRODUCT EVALUATION**  
.01 Plastics and Textiles  
.02 Fibrous Systems  
.03 Viscoelastic Materials  
.04 Paper Evaluation  
.06 Fabric Flammability  
Dr. Sanford B. Newman  
Karl F. Plitt  
Donald G. Fletcher  
George E. Decker (Acting)  
William K. Wilson  
James V. Ryan
- 412 NBS/GSA TEST AND DEVELOPMENT**  
Deputy Chief  
Philip J. Franklin  
Dr. Roger W. Curtis
- 421 BUILDING RESEARCH**  
Deputy Chief  
Consultant to Chief  
.01 Structures  
.02 Fire Research  
.03 Environmental Engineering  
.04 Materials Durability and Analysis  
.05 Codes and Standards  
.06 Building Systems  
.07 Scientific and Professional Liaison  
Dr. James R. Wright  
Paul R. Achenbach  
Dr. Bruce E. Foster  
Dr. Edward O. Pfrang  
Dr. Alexander F. Robertson  
Henry E. Robinson  
William C. Cullen  
Gene A. Rowland  
Robert W. Blake  
Dr. William W. Walton
- 425 ELECTRONIC INSTRUMENTATION**  
Assistant to Chief  
Consultant  
.01 Semiconductor Characterization  
.02 Electron Devices  
.03 Instrumentation Applications  
.04 Semiconductor Processing  
Myron G. Domsitz  
Gustave Shapiro  
Charles P. Marsden  
Dr. W. Murray Bullis  
Judson C. French  
Joshua Stern  
Dr. Joseph A. Coleman

<p><b>431 TECHNICAL ANALYSIS</b>  Deputy Chief  .01 Corridor and Highway Studies  .02 Systems Analysis and Human Factors  .03 Economic Analysis  .04 Development of New Methodology</p>	<p>Dr. W. Edward Cushen  Dr. George Suzuki  Abraham E. Karp  Cleveland Hopkins  Dr. Howard E. Morgan  Dr. George Suzuki</p>
<p><b>450 CENTER FOR COMPUTER SCIENCES AND TECHNOLOGY</b>  Director  Deputy Director  Consultant</p>	<p>Dr. Herbert R. J. Grosch  William C. Bieber  Mary Elizabeth Stevens</p>
<p><b>451 OFFICE FOR INFORMATION PROCESSING STANDARDS</b></p>	<p>Dr. Joseph O. Harrison, Jr.</p>
<p><b>452 TECHNICAL INFORMATION EXCHANGE</b></p>	<p>Margaret R. Fox</p>
<p><b>453 COMPUTER SERVICES</b></p>	<p>W. Bruce Ramsay (Acting)</p>
<p><b>455 SYSTEMS RESEARCH AND DEVELOPMENT</b></p>	<p>Ethel C. Marden</p>
<p><b>456 INFORMATION PROCESSING TECHNOLOGY</b></p>	<p>James P. Nigro</p>
<p><b>500 CENTER FOR RADIATION RESEARCH</b>  Director  Deputy Director  .01 Radiation Theory  .02 Health Physics</p>	<p>Dr. Carl O. Muehlhause (Acting)  Dr. Randall S. Caswell (Acting)  Dr. Martin J. Berger  Dr. Abraham Schwebel</p>
<p><b>501 REACTOR RADIATION</b>  .01 Reactor Operations  .02 Engineering Services  .03 Neutron Solid-State Physics  .04 Radiation Effects</p>	<p>Dr. Robert S. Carter (Acting)  Tawfik M. Raby (Acting)  James P. Knight  Dr. Robert S. Carter  Vacant</p>
<p><b>502 LINAC RADIATION</b>  .01 Linac Operations  .02 Radiation Physics Instrumentation  .03 Photonuclear Physics  .04 Electronuclear Physics</p>	<p>Dr. James E. Leiss (Acting)  Dr. James E. Leiss  Louis Costrell  Dr. Everett G. Fuller  Dr. Samuel Penner</p>
<p><b>503 NUCLEAR RADIATION</b>  .01 Neutron Physics  .02 Radioactivity  .03 Nuclear Spectroscopy</p>	<p>Dr. Harry H. Landon (Acting)  Dr. Harry H. Landon  Dr. Wilfred B. Mann  Dr. Raymond W. Hayward</p>
<p><b>504 APPLIED RADIATION</b>  .01 X-ray Physics  .02 Dosimetry</p>	<p>Dr. Joseph W. Motz (Acting)  Dr. Joseph W. Motz  Thomas P. Loftus (Acting)</p>

\* Laboratories located in Boulder, Colorado.

## **FIELD STATIONS**

Visual Landing Aids Laboratory, Arcata, CA

U.S. Joint Publications Research Service, San Francisco, CA

Scientific Observations and Measurements Site, Poor Man's Mine, Four Mile Canyon, Boulder, CO

Standard Frequency Stations WWVB/WWVL, Fort Collins, CO

Radio Propagation and Standard Frequency Station WWVH, Puunene, Maui, HA

Master Railway Track Scale Depot, Clearing, IL

U.S. Joint Publications Research Service, New York, NY

January 6, 1969

**100 OFFICE OF THE DIRECTOR**

Director  
Deputy Director  
Assistant to the Director  
Assistant to the Director  
Assistant to the Director  
Special Assistant for Program Planning  
Assistant to the Director for Metric Study  
Senior Research Fellow

Dr. Allen V. Astin  
Dr. Lawrence M. Kushner (Acting)  
Dr. Robert D. Huntoon  
George E. Auman  
Clarence N. Coates  
Dr. Robert E. Ferguson  
Alvin G. McNish  
Dr. Churchill Eisenhart

**105 OFFICE OF ACADEMIC LIAISON**

Associate Director for Academic Liaison

Dr. Shirleigh Silverman

**120 OFFICE OF ASSOCIATE DIRECTOR FOR ADMINISTRATION**

Associate Director  
Deputy Associate Director for Administration

Robert S. Walleigh  
Paul H. Schrader

**121 ACCOUNTING**

Deputy Chief  
.01 Reports and Billing  
.03 Tabulation  
.05 Payroll  
.10 Cost and Payments Branch  
.16 Accounts Payable  
.18 Project Accounting

James P. Menzer  
David B. Shreve  
Pearl E. Miller  
Ralph A. Bryson  
Kathryn L. Rock  
Henry L. Kenno  
Matilda Udoff  
Robert F. Martin

**122 ADMINISTRATIVE SERVICES**

Assistant Chief  
Fire Protection Service  
.01 Mail and Distribution  
.02 Special Services  
.03 Janitorial Services  
.04 Guard Services  
.05 Transportation Services

George W. Knox  
Vacant  
Charles O. Baker  
Howard L. Sampson  
Walter J. Rabbitt  
Robert E. Roberts  
Capt. William J. Kane  
Charles W. Anderson

**123 BUDGET**

Deputy

Dr. James E. Skillington, Jr.  
Eugene C. Denne

**125 PERSONNEL**

Assistant Chief  
.02 Recruitment and Placement  
.03 Salary and Wage Administration  
.04 Employee Development and Relations  
.05 Operations and Procedures  
.06 Medical Office

George R. Porter  
Henry C. Bothe  
Dale J. Houston  
Roy V. Stapleton  
Robert F. Bain  
Peggy A. Bickel  
George H. L. Dillard, MD

<b>126</b>	<b>PLANT</b>	
	Assistant Chief	Hylton Graham
	.01 Steam-Chilled Water Generation	M. Bernard Goetz
	.02 Electric Shop	James S. Powers
	.03 Piping Shop	Robert W. Miller
	.04 Construction Shop	Gerard J. Finan
	.06 Labor Services	John A. King
	.07 Metal Shop	Roy B. Powell
	.08 Air Conditioning and Refrigeration	Donald I. Thompson
	.09 Grounds	Dominic J. Giampietro
		William R. Stevenson
<b>127</b>	<b>SUPPLY</b>	
	Deputy Chief	George B. Kefover
	.01 Storeroom Services	Norman H. Taylor
	.02 Travel Office	Walter C. Bonner
	.03 Procurement	Mary H. Jenner
	.04 Property Management	Gordon A. Cauley, Jr.
	.05 Telephone Office	Robert E. Wilson
		Pat Hafen
<b>128</b>	<b>MANAGEMENT AND ORGANIZATION</b>	
	Consultive Services	John T. Hall
	Records Management Officer	Wayne B. Davis
	Administrative Issuances	Walter W. Weinstein
	Management Surveys	Marguerite R. Hubkans
	Management Systems	Iris M. Lloyd
		Joseph C. Aubele
<b>STAFF AND TECHNICAL SUPPORT UNITS REPORTING TO THE DEPUTY DIRECTOR</b>		
<b>143</b>	<b>OFFICE OF INDUSTRIAL SERVICES</b>	Dr. George S. Gordon
<b>144</b>	<b>OFFICE OF ENGINEERING STANDARDS LIAISON</b>	Dr. A. Allan Bates
<b>145</b>	<b>INSTRUMENT SHOPS</b>	
	Assistant Chief	Frank P. Brown
	.01 Instrument Shop #1	Winfield L. Drissel
	.02 Instrument Shop #2	Earl L. Schwenk
	.03 Instrument Shop #3	Walter A. Koepper
	.04 Instrument Shop #4	Charles E. Taylor
	.05 Instrument Shop #5	Phillip Pfaff, Jr.
	.06 Glassblowing	John R. Pidgeon
	.07 Welding and Sheet Metal Shop	Enrico Deleonibus
	.08 Optical Shop	Harold E. Brown
	.09 Tool Crib	Stanley W. Gerner
	.10 Electroplating	Herbert Robinson (Acting)
		Frank P. Brown (Acting)
<b>146</b>	<b>MEASUREMENT ENGINEERING</b>	
	.01 Electronic Instrumentation	G. Franklin Montgomery
	.02 Electronic Optical Development	Robert J. Carpenter
	.03 Microwave and Mechanical Instrumentation	M. Leighton Greenough
		Robert O. Stone

- 150 OFFICE OF THE ASSOCIATE DIRECTOR FOR INFORMATION PROGRAMS**  
Associate Director Dr. Edward L. Brady (Acting)
- 151 OFFICE OF STANDARD REFERENCE DATA**  
Atomic and Molecular Data Dr. David R. Lide, Jr. (Acting)  
Chemical Kinetics Dr. Lewis H. Gevantman  
Colloid and Surface Chemistry Dr. Lewis H. Gevantman  
Information Services Dr. Howard J. White, Jr.  
Data Systems Design Dr. Herman M. Weisman  
Mechanical Properties Joseph Hilsenrath  
Nuclear Data Dr. Lewis H. Gevantman  
Solid State Properties Dr. David Goldman  
Thermodynamics and Transport Data Dr. Lewis H. Gevantman  
Dr. Howard J. White, Jr.
- 152 Clearinghouse for Federal Scientific and Technical Information**  
Director Hubert E. Sauter  
Deputy Director Peter F. Urbach  
.10 Document Distribution and Reproduction Branch Alvin W. Alexander  
.30 Automated Systems and Services Branch Mitchell A. Krasny  
.60 Administrative Operations Branch Joseph G. Coyne  
.70 Joint Publications Research Service Gustav Blackett  
.80 Document Processing Branch George K. Kudravetz (Acting)
- 153 OFFICE OF TECHNICAL INFORMATION AND PUBLICATIONS**  
Assistant Chief W. Reeves Tilley  
.01 Special Activities William K. Gautier  
.02 Editorial Robert T. Cook  
.03 Publications William K. Gautier  
.04 Photographic Services John E. Carpenter  
.05 Graphic Arts Warren P. Richardson  
.06 Computer Assisted Printing Conrad F. Peters  
Rubin Wagner
- 154 LIBRARY**  
.01 Resources Development Dr. Elizabeth L. Tate  
.02 Reader Services Ruth J. Manning  
.03 Library Auxiliaries Maggie Cason  
Dr. Elizabeth L. Tate (Acting)
- 155 OFFICE OF PUBLIC INFORMATION**  
A. Victor Gentilini
- 156 OFFICE OF INTERNATIONAL RELATIONS**  
Dr. Ladislaus L. Marton
- 200 INSTITUTE FOR BASIC STANDARDS**  
Director Dr. Ernest Ambler  
Assistant Director Dr. R. Joseph Corruccini (Acting)  
Scientific Assistant to the Director, IBS Dr. Ian R. Barky  
Consultants for Fundamental Constants Dr. Richard D. Deslattes  
Dr. Peter L. Bender  
.01 Office of Measurement Services Joseph M. Cameron (Acting)
- 205 APPLIED MATHEMATICS**  
.01 Numerical Analysis Dr. Edward W. Cannon  
.02 Operations Research Dr. Morris Newman  
.03 Statistical Engineering Dr. Alan J. Goldman  
.04 Systems Dynamics Dr. Joan Rosenblatt (Acting)  
Dr. Hansjorg Oser



- 211 ELECTRICITY**  
 .01 Resistance and Reactance  
 .02 Electrochemistry  
 .03 Electrical Instruments  
 .06 High Voltage  
 .07 Absolute Electrical Measurements
- 212 METROLOGY**  
 Assistant Chief  
 Consultant in Photometry  
 .11 Photometry  
 .13 Image Optics and Photography  
 .14 Colorimetry and Spectrophotometry  
 .21 Length  
 .22 Engineering Metrology  
 .31 Mass and Volume
- 213 MECHANICS**  
 Assistant Chief for Fluid Mechanics  
 Consultant  
 .01 Sound  
 .02 Vibration Measurements  
 .04 Engineering Mechanics  
 .05 Rheology  
 .06 Fluid Meters  
 .07 Hydraulics  
 .08 Aerodynamics  
 .20 Mechanical Measurements Branch  
 .21 Pressure Measurements  
 .22 Vacuum Measurements  
 .24 Humidity Measurements
- 221 HEAT**  
 Assistant Chief for Thermodynamics  
 .02 Heat Measurements  
 .03 Cryogenic Physics  
 .04 Equation of State  
 .05 Statistical Physics  
 .11 Temperature  
 .12 Radiation Thermometry
- 222 ATOMIC AND MOLECULAR PHYSICS**  
 .01 Spectroscopy  
 .02 Infrared Spectroscopy  
 .03 Far Ultraviolet Physics  
 .04 Molecular Spectroscopy  
 .05 Electron Physics  
 .06 Atomic Physics  
 .07 Plasma Spectroscopy
- Dr. Chester H. Page  
 Chester Peterson  
 Dr. Walter J. Hamer  
 Francis L. Hermach  
 Dr. F. Ralph Kotter  
 Dr. Forest K. Harris
- Theodore R. Young (Acting)  
 Dr. Deane B. Judd  
 Louis E. Barbrow  
 Charles A. Douglas  
 Calvin S. McCamy  
 Isadore Nimeroff  
 John S. Beers (Acting)  
 Arthur G. Strang  
 Paul E. Pontius
- Lafayette K. Irwin (Acting)  
 Philip S. Klebanoff  
 Dr. Daniel P. Johnson  
 Martin Greenspan  
 Roscoe L. Bloss  
 Douglas R. Tate (Acting)  
 Dr. Robert S. Marvin  
 Fillmer W. Ruegg  
 Dr. Gershon Kulin  
 Philip S. Klebanoff  
 Edward C. Lloyd  
 Edward C. Lloyd (Acting)  
 Stanley Ruthberg  
 Arnold Wexler
- Dr. Ralph P. Hudson  
 Dr. Charles W. Beckett  
 Dr. Defoe C. Ginnings  
 Dr. James F. Schooley (Acting)  
 Dr. Max Klein  
 Dr. Raymond D. Mountain (Acting)  
 Dr. Harmon H. Plumb  
 Dr. Henry J. Kostkowski
- Dr. Karl G. Kessler  
 Dr. William C. Martin, Jr.  
 Dr. Arthur G. Maki (Acting)  
 Dr. Robert P. Madden  
 Dr. Jon T. Hougen (Acting)  
 Dr. John A. Simpson  
 Dr. Richard D. Deslattes  
 Dr. Wolfgang L. Wiese

**\*270 OFFICE OF DEPUTY DIRECTOR, IBS/BOULDER**

- Deputy Director
- .01 Office of Program Development and Evaluation
- .02 Office of Management Systems

Bascom W. Birmingham (Acting)  
Dr. Thomas M. Flynn  
Roy W. Stockwell, Jr.

**\*271 RADIO STANDARDS PHYSICS**

- Consultant
- Consultant
- .01 Solid State Electronics
- .05 Quantum Electronics
- .06 Plasma Physics

Dr. Harold S. Boyne (Acting)  
Dr. L. Yardley Beers  
Thomas W. Russell  
Dr. Robert J. Mahler  
Dr. Donald A. Jennings  
Dr. Karl B. Persson

**\*272 RADIO STANDARDS ENGINEERING**

- Consultant
- Consultant
- Consultant
- Consultant
- Consultant
- .23 HF Impedance Standards
- .24 RF Transmission and Noise
- .25 RF Power and Voltage
- .31 Microwave Calibration Services
- .32 Microwave Circuit Standards
- .42 Electromagnetic Fields Standards

Dr. Helmut M. Altschuler  
Robert W. Beatty  
John L. Dalke  
Dr. David M. Kerns  
Myron C. Selby  
Eldred C. Wolzien  
Leslie E. Huntley (Acting)  
Charles M. Allred  
Paul A. Hudson  
Roy E. Larson  
Dr. George E. Schafer  
Dr. Ramon C. Baird

**\*273 TIME AND FREQUENCY**

- Assistant Chief
- Consultant
- Consultant
- .01 Frequency-Time Dissemination Research
- .02 Frequency-Time Broadcast Services
- .04 Atomic Frequency-Time Standards

Dr. James A. Barnes  
Roger E. Beehler  
R. Lowell Fey  
Dr. George E. Hudson  
James L. Jespersen  
Peter P. Viezbicke  
Dr. Donald W. Halford

**\*274 LABORATORY ASTROPHYSICS**

- Deputy Chief

Dr. Lewis M. Branscomb  
Dr. Stephen J. Smith

**\*275 CRYOGENICS**

- Associate Chief
- Consultant
- .01 Cryogenic Technical Services
- .02 Cryogenic Data Center
- .03 Cryogenic Properties of Solids
- .04 Properties of Cryogenic Fluids
- .05 Cryogenic Systems
- .06 Cryogenic Metrology
- .07 Cryogenic Fluid Transport Processes

Dudley B. Chelton (Acting)  
Dr. Richard H. Kropschot  
Alan F. Schmidt  
William A. Wilson  
Victor J. Johnson  
Dr. Robert L. Powell  
Dwain E. Diller  
Robert W. Arnett  
Douglas B. Mann  
Raymond V. Smith

**\*281 ADMINISTRATIVE SERVICES**

- .01 Supply
- .02 Office Services
- .03 Drafting Services

Barton F. Betts  
J. S. Roettenbacher  
Richard G. Bulgin  
Victor J. Pfannenstiel

<b>*282</b>	<b>INSTRUMENT SHOPS</b>	
	Consultant-Engineering	Rodney S. Perrill
	.01 Instrument Shop 1	Jay N. Edmondson
	.02 Instrument Shop 2	Vernon E. Hill
	.03 Welding-Sheet Metal	Henry C. Leistner
	.04 Glass Blowing Shop	James H. McCarron
		H. L. Hoyt
<b>*283</b>	<b>PLANT</b>	
	Deputy Chief	Edgar A. Yuzwiak
	.01 Construction-Maintenance	George M. Musick, Jr.
	.02 Special Services	Robert W. Eddy
	.03 Custodial Services	Williams D. Hitchcock
		Wilmer L. Schweikert
<b>300</b>	<b>INSTITUTE FOR MATERIALS RESEARCH</b>	
	Director	Dr. John D. Hoffman
	Assistant to the Director	Dr. Emanuel Horowitz
<b>302</b>	<b>OFFICE OF STANDARD REFERENCE MATERIALS</b>	
	Deputy Chief	Dr. W. Wayne Meinke
		Joseph P. Cali
<b>310</b>	<b>ANALYTICAL CHEMISTRY</b>	
	Consultant	Dr. W. Wayne Meinke
	.01 Radiochemical Analysis	Dr. Charles P. Saylor
	.02 Spectrochemical Analysis	Dr. James R. DeVoe
	.03 Electrochemical Analysis	Bourdon F. Scribner
	.04 Analytical Coordination Chemistry	Dr. Roger G. Bates
	.05 Microchemical Analysis	Dr. Oscar Menis
	.06 Analytical Mass Spectrometry	Dr. John K. Taylor
	.07 Organic Chemistry	William R. Shields
	.08 Activation Analysis	Dr. Robert Schaffer
	.09 Separation and Purification	Dr. Philip D. LaFleur
		Dr. David H. Freeman
<b>311</b>	<b>POLYMERS</b>	
	Consultant on Rubber and Polymers	Dr. Ronald K. Eby (Acting)
	.01 Polymer Dielectrics	Dr. Lawrence A. Wood
	.02 Polymer Chemistry	Dr. Martin G. Broadhurst
	.03 Polymer Crystal Physics	Dr. Leo A. Wall
	.04 Molecular Properties	Dr. Ronald K. Eby
	.05 Dental Research	Dr. Cornelis A. J. Hoeve
	.06 Polymer Characterization	Dr. James M. Cassel (Acting)
	.07 Polymer Interfaces	Dr. Cornelis A. J. Hoeve (Acting)
	.08 Thermophysical Properties	Dr. Robert R. Stromberg
		Dr. Alden B. Bestul
<b>312</b>	<b>METALLURGY</b>	
	.01 Engineering Metallurgy	Dr. Elio Passalia
	.02 Alloy Physics	Dr. Melvin R. Meyerson
	.03 Lattice Defects and Microstructures	Dr. Lawrence H. Bennett
	.04 Corrosion	Dr. A. William Ruff, Jr.
	.05 Metal Physics	Dr. Jerome Kruger
	.06 Electrolysis and Metal Deposition	Dr. John R. Manning
	.07 Crystallization of Metals	Dr. Abner Brenner
		Dr. Robert L. Parker

- 313 INORGANIC MATERIALS**  
 Consultant  
 Consultant  
 Consultant  
 Consultant  
 Consultant  
 Consultant  
 .01 Inorganic Chemistry  
 .02 Inorganic Glass  
 .03 High Temperature Chemistry  
 .05 Physical Properties  
 .06 Crystallography  
 .07 Solid State Physics
- 316 PHYSICAL CHEMISTRY**  
 Consultant  
 .11 Thermochemistry  
 .21 Surface Chemistry  
 .51 Elementary Processes  
 .52 Mass Spectrometry  
 .53 Photo Chemistry  
 .54 Radiation Chemistry
- 400 INSTITUTE FOR APPLIED TECHNOLOGY**  
 Director
- 402 ENGINEERING STANDARDS**
- 403 OFFICE OF ENGINEERING STANDARDS SERVICES**  
 .01 Product Standards  
 .02 Standards Information  
 .03 Mandatory Standards
- 404 OFFICE OF WEIGHTS AND MEASURES**  
 Assistant Chief
- 406 OFFICE OF INVENTION AND INNOVATION**  
 .01 Innovation Studies Program  
 .02 Invention Programs  
 .03 Engineering Education Program
- 408 OFFICE OF VEHICLE SYSTEMS RESEARCH**  
 Deputy Chief  
 .01 Tire Systems  
 .02 Occupant Restraint Systems  
 .03 Braking Systems
- 411 PRODUCT EVALUATION**  
 .01 Plastics and Textiles  
 .02 Fibrous Systems  
 .03 Viscoelastic Materials  
 .04 Paper Evaluation  
 .06 Fabric Flammability
- Dr. John B. Wachtman, Jr.  
 Dr. Arthur I. Bienenstock  
 Dr. Gilbert Gordon  
 Dr. Ellis R. Lippincott  
 Dr. Howard F. McMurdie  
 H. Steffen Peiser  
 Dr. James M. Stewart  
 Dr. Thomas D. Coyle  
 Dr. Wolfgang Haller  
 Dr. William S. Horton  
 Dr. Sheldon H. Wiederhorn  
 Dr. Stanley Block  
 Dr. Hans P. R. Frederikse
- Dr. James R. McNesby (Acting)  
 Edward J. Prosen  
 Dr. George T. Armstrong  
 Dr. Ralph Klein  
 Dr. David Garvin  
 Dr. Henry M. Rosenstock  
 Dr. Milton D. Scheer  
 Dr. Pierre J. Ausloss
- Dr. Howard E. Sorrows (Acting)
- Malcolm W. Jensen
- Donald R. MacKay  
 Herbert A. Philo  
 William J. Slattery (Acting)  
 Donald R. MacKay (Acting)
- Malcolm W. Jensen  
 Harold F. Wollin
- Daniel V. DeSimone  
 Joseph D. Crumlish  
 Leonard S. Hardland  
 John M. Tascher
- Paul J. Brown  
 Dr. F. Cecil Brenner (Acting)  
 Dr. F. Cecil Brenner  
 Richard W. Armstrong  
 Robert J. Forthofer
- Dr. Sanford B. Newman  
 Karl F. Plitt  
 Donald G. Fletcher  
 George E. Decker (Acting)  
 William K. Wilson  
 James V. Ryan

- 421 BUILDING RESEARCH**  
 Deputy Chief  
 Consultant to Chief  
 .01 Structures  
 .02 Fire Research  
 .04 Materials Durability and Analysis  
 .05 Codes and Standards  
 .06 Building Systems  
 .07 Scientific and Professional Liaison  
**.10 Sensory Environment Branch**  
 .11 Environmental Engineering  
 .12 Psycho-Physics  
 .13 Building Transport Systems
- 425 ELECTRONIC TECHNOLOGY**  
 Consultant  
 .01 Semiconductor Characterization  
 .02 Electron Devices  
 .03 Instrumentation Applications  
 .04 Semiconductor Processing
- 431 TECHNICAL ANALYSIS**  
 Deputy Chief for Project Operations  
 Deputy Chief for Quality Control  
 Socio-Economic Studies  
 Simulation and Transportation Studies  
 Operations Research in Behavioral Science  
 Post Office Studies  
 Corridor Model System  
 Systems Analysis for Commerce
- 500 CENTER FOR RADIATION RESEARCH**  
 Director  
 Deputy Director  
 .01 Radiation Theory  
 .02 Health Physics
- 501 REACTOR RADIATION**  
 .01 Reactor Operations  
 .02 Engineering Services  
 .03 Neutron Solid-State Physics  
 .04 Radiation Effects
- 502 LINAC RADIATION**  
 .01 Linac Operations  
 .02 Radiation Physics Instrumentation  
 .03 Photonuclear Physics  
 .04 Electronuclear Physics
- 503 NUCLEAR RADIATION**  
 .01 Neutron Physics  
 .02 Radioactivity  
 .03 Nuclear Spectroscopy
- Dr. James R. Wright  
 Harry E. Thompson (Acting)  
 Dr. Bruce E. Foster  
 Dr. Edward O. Pfrang  
 Irwin A. Benjamin  
 William C. Cullen  
 Gene A. Rowland  
 Robert W. Blake  
 Dr. William W. Walton  
 Paul R. Achenbach  
 Frank J. Powell (Acting)  
 Herbert Robinson (Acting)  
 Paul R. Achenbach (Acting)
- Myron G. Domsitz  
 Charles P. Marsden  
 Dr. W. Murray Bullis  
 Judson C. French  
 Joshua Stern  
 Dr. Joseph A. Coleman
- Dr. W. Edward Cushen  
 Abraham E. Karp  
 Dr. George Suzuki  
 Dr. George Suzuki (Acting)  
 Louis C. Santone  
 Dr. June R. Cornog  
 William F. Druckenbrod  
 Ralph E. Schofer  
 John W. Locke
- Dr. Carl O. Muehlhause (Acting)  
 Dr. Randall S. Caswell (Acting)  
 Dr. Martin J. Berger  
 Dr. Abraham Schwebel
- Dr. Robert S. Carter (Acting)  
 Tawfik M. Raby (Acting)  
 John H. Nicklas  
 Dr. Robert S. Carter  
 Vacant
- Dr. James E. Leiss (Acting)  
 Dr. James E. Leiss  
 Louis Costrell  
 Dr. Everett G. Fuller  
 Dr. Samuel Penner
- Dr. Harry H. Landon (Acting)  
 Dr. Harry H. Landon  
 Dr. Wilfred B. Mann  
 Dr. Raymond W. Hayward

<b>504</b>	<b>APPLIED RADIATION</b>	Dr. Joseph W. Motz (Acting)
	.01 X-ray Physics	Dr. Joseph W. Motz
	.02 Dosimetry	Dr. Robert Loevinger
<b>600</b>	<b>CENTER FOR COMPUTER SCIENCES AND TECHNOLOGY</b>	
	Director	Dr. Herbert R. J. Grosch
	Consultant	Mary Elizabeth Stevens
	.10 Manager-Pattern Recognition and Description Program	Joseph H. Wegstein
<b>610</b>	<b>OFFICE FOR INFORMATION PROCESSING STANDARDS</b>	Dr. Joseph O. Harrison, Jr.
<b>620</b>	<b>OFFICE FOR COMPUTER INFORMATION</b>	Margaret R. Fox
<b>630</b>	<b>COMPUTER SERVICES</b>	W. Bruce Ramsay (Acting)
<b>640</b>	<b>SYSTEMS DEVELOPMENT</b>	Charles T. Meadow
<b>650</b>	<b>INFORMATION PROCESSING TECHNOLOGY</b>	James P. Nigro

\* Laboratories located in Boulder, Colorado.

#### FIELD STATIONS

Visual Landing Aids Laboratory, Arcata, CA  
 U.S. Joint Publications Research Service, San Francisco, CA  
 Scientific Observations and Measurements Site, Poor Man's Mine, Four Mile Canyon, Boulder, CO  
 Standard Frequency Stations WWVB/WWVL, Fort Collins, CO  
 Radio Propagation and Standard Frequency Station WWVH, Puunene, Maui, HA  
 Master Railway Track Scale Depot, Clearing, IL  
 U.S. Joint Publications Research Service, New York, NY

September 2, 1969

- 100 OFFICE OF THE DIRECTOR**  
Director  
Deputy Director  
Assistant to the Director  
Assistant to the Director  
Assistant to the Director  
Dr. Lewis M. Branscomb  
Dr. Lawrence M. Kushner  
Dr. Robert D. Huntoon  
George E. Auman  
Clarence N. Coates
- 105 OFFICE OF ACADEMIC LIAISON**  
Associate Director for Academic Liaison  
Dr. Shirleigh Silverman
- 120 OFFICE OF ASSOCIATE DIRECTOR FOR ADMINISTRATION**  
Associate Director  
Deputy Associate Director for Administration  
Robert S. Walleigh  
Paul H. Schrader
- 121 ACCOUNTING**  
Deputy Chief  
.01 Reports and Billing  
.03 Tabulation  
.05 Payroll  
.10 Cost and Payments Branch  
.16 Accounts Payable  
.18 Project Accounting  
James P. Menzer  
David B. Shreve  
Pearl E. Miller  
Henry R. Robinette, Jr.  
Kathryn L. Rock  
Henry L. Kenno  
Matilda Udoff  
John W. Wisner
- 122 ADMINISTRATIVE SERVICES**  
Assistant to the Chief  
.01 Mail and Distribution  
.02 Special Services  
.03 Janitorial Services  
.04 Physical Security  
.05 Transportation Services  
.06 Safety and Fire Protection  
George W. Knox  
Walter J. Rabbitt  
Howard L. Sampson  
Nicholas C. Chaconas  
Robert E. Roberts  
Capt. William J. Kane  
Charles W. Anderson  
Lyman E. Pevey, Jr.
- 123 BUDGET**  
Deputy  
Dr. James E. Skillington, Jr.  
Eugene C. Denne
- 125 PERSONNEL**  
Assistant Chief  
.02 Recruitment and Placement  
.03 Salary and Wage Administration  
.04 Employee Development and Relations  
.05 Operations and Procedures  
.06 Medical Office  
George R. Porter  
Henry C. Bothe  
Dale J. Houston  
Roy V. Stapleton  
Robert F. Bain  
Peggy A. Bickel  
George H. L. Dillard, MD
- 126 PLANT**  
Assistant Chief  
.01 Steam-Chilled Water Generation  
.02 Electric Shop  
.03 Piping Shop  
.04 Construction Shop  
Hylton Graham  
M. Bernard Goetz  
James S. Powers  
Robert W. Miller  
Kenneth L. Lowe  
John A. King

.06	Labor Services	Roy B. Powell
.07	Metal Shop	Donald I. Thompson
.08	Air Conditioning and Refrigeration	Dominic J. Giampietro
.09	Grounds	William R. Stevenson
<b>127</b>	<b>SUPPLY</b>	Norman H. Taylor
	Deputy Chief	Vacant
.01	Storeroom Services	Walter C. Bonner
.02	Travel Office	Mary H. Jenner
.03	Procurement	Gordon A. Cauley, Jr.
.04	Property Management	Robert E. Wilson
.05	Telephone Office	Pat Hafen
<b>128</b>	<b>MANAGEMENT AND ORGANIZATION</b>	John T. Hall
	Consultive Services	Wayne B. Davis
	Administrative Issuances	Marguerite R. Hubanks
	Management Surveys	Iris M. Lloyd
	Management Systems	Joseph C. Aubele
<b>STAFF UNITS REPORTING TO THE DEPUTY DIRECTOR</b>		
<b>143</b>	<b>OFFICE OF INDUSTRIAL SERVICES</b>	Dr. George S. Gordon
<b>144</b>	<b>OFFICE OF ENGINEERING STANDARDS LIAISON</b>	Dr. A. Allan Bates
<b>150</b>	<b>OFFICE OF THE ASSOCIATE DIRECTOR FOR INFORMATION PROGRAMS</b>	
	Associate Director	Dr. Edward L. Brady
	Assistant to the Associate Director	Paul H. Kratz (Acting)
	Consultant	Dr. Ladislaus L. Marton (Acting)
<b>151</b>	<b>OFFICE OF STANDARD REFERENCE DATA</b>	Dr. David R. Lide, Jr.
	Atomic and Molecular Data	Dr. Lewis H. Gevantman
	Chemical Kinetics	Dr. Lewis H. Gevantman
	Colloid and Surface Chemistry	Dr. Howard J. White, Jr.
	Information Services	Dr. Herman M. Weisman
	Data Systems Design	Joseph Hilsenrath
	Mechanical Properties	Dr. Lewis H. Gevantman
	Nuclear Data	Dr. David Goldman
	Solid State Properties	Dr. Lewis H. Gevantman
	Thermodynamics and Transport Data	Dr. Howard J. White, Jr.
<b>152</b>	<b>CLEARINGHOUSE FOR FEDERAL SCIENTIFIC AND TECHNICAL INFORMATION</b>	
	Director	Hubert E. Sauter
	Assistant Director, Operations	Joseph G. Coyne
.10	Document Distribution and Reproduction Branch	Alvin W. Alexander
.30	Automated Systems and Services Branch	Mitchell A. Krasny
.60	Administrative Operations Branch	Joseph G. Coyne (Acting)
.70	Joint Publications Research Service	Gustav Blackett
.80	Document Processing Branch	George K. Kudravetz



- 153 OFFICE OF TECHNICAL INFORMATION AND PUBLICATIONS**  
 Assistant Chief  
 .01 Special Activities  
 .02 Editorial  
 .03 Publications  
 .04 Photographic Services  
 .05 Graphic Arts  
 .06 Computer Assisted Printing
- 154 LIBRARY**  
 .01 Resources Development  
 .02 Reader Services  
 .03 Library Auxiliaries
- 155 OFFICE OF PUBLIC INFORMATION**
- 156 OFFICE OF INTERNATIONAL RELATIONS**
- 200 INSTITUTE FOR BASIC STANDARDS**  
 Director  
 Assistant Director  
 Senior Research Fellow  
 Consultants for Fundamental Constants  
 .01 Office of Measurement Services
- 205 APPLIED MATHEMATICS**  
 Deputy Chief for Program Planning  
 .01 Numerical Analysis  
 .02 Operations Research  
 .03 Statistical Engineering  
 .04 Systems Dynamics
- 211 ELECTRICITY**  
 Deputy Chief  
 .01 Resistance and Reactance  
 .02 Electrochemistry  
 .03 Electrical Instruments  
 .06 High Voltage  
 .07 Absolute Electrical Measurements
- 212 METROLOGY**  
 Deputy Chief  
 Consultant in Photometry  
 .11 Photometry  
 .13 Image Optics and Photography  
 .14 Spectrophotometry  
 .21 Length  
 .22 Engineering Metrology  
 .31 Mass and Volume
- W. Reeves Tilley  
 Robert T. Cook  
 Robert T. Cook  
 Donald V. Baker  
 W. Reeves Tilley (Acting)  
 Warren P. Richardson  
 Conrad F. Peters  
 Rubin Wagner
- Dr. Elizabeth L. Tate  
 Ruth J. Manning  
 Maggie Cason  
 Marvin A. Bond, Jr.
- A. Victor Gentilini
- H. Steffen Peiser (Acting)
- Dr. Ernest Ambler  
 Dr. R. Joseph Corruccini  
 Dr. Churchill Eisenhart  
 Dr. Richard D. Deslattes  
 Dr. Peter L. Bender  
 Joseph M. Cameron
- Dr. Edward W. Cannon  
 Dr. Alan J. Goldman  
 Dr. Morris Newman  
 Dr. Alan J. Goldman  
 Dr. Joan Rosenblatt  
 Dr. Hansjorg Oser
- Dr. Chester H. Page  
 Francis L. Hermach (Acting)  
 Chester Peterson  
 Dr. Walter J. Hamer  
 Francis L. Hermach  
 Dr. F. Ralph Kotter  
 Dr. Forest K. Harris
- Dr. Karl G. Kessler (Acting)  
 Dr. John A. Simpson (Acting)  
 Louis E. Barbrow  
 Charles A. Douglas  
 Calvin S. McCamy  
 Dr. Robert P. Madden (Acting)  
 Paul E. Pontius (Acting)  
 Arthur G. Strang  
 Paul E. Pontius

- 213 MECHANICS**  
 Assistant Chief for Fluid Mechanics  
 Consultant  
 .01 Sound  
 .02 Vibration Measurements  
 .03 Humidity Measurements  
 .04 Engineering Mechanics  
 .05 Rheology  
 .06 Fluid Meters  
 .07 Hydraulics  
 .08 Aerodynamics
- 221 HEAT**  
 .03 Cryogenic Physics  
 .04 Equation of State  
 .05 Statistical Physics  
 .07 Pressure Measurements  
 .11 Temperature  
 .12 Radiation Thermometry
- 222 ATOMIC AND MOLECULAR PHYSICS**  
 Deputy Chief  
 .01 Spectroscopy  
 .02 Infrared Spectroscopy  
 .03 Far Ultraviolet Physics  
 .04 Molecular Spectroscopy  
 .05 Electron Physics  
 .06 Atomic Physics  
 .07 Plasma Spectroscopy  
 .08 Vacuum Measurements
- \*270 OFFICE OF DEPUTY DIRECTOR, IBS/BOULDER**  
 Deputy Director  
 Senior Research Fellow  
 Senior Research Fellow  
 .01 Office of Program Coordination  
 .02 Executive Assistant to the Deputy Director
- \*271 RADIO STANDARDS PHYSICS**  
 Consultant  
 Consultant  
 .01 Solid State Electronics  
 .05 Quantum Electronics  
 .06 Plasma Physics
- \*272 RADIO STANDARDS ENGINEERING**  
 Associate Chief  
 Senior Research Scientist  
 Consultant  
 Consultant  
 Consultant  
 Consultant
- Lafayette K. Irwin  
 Philip S. Klebanoff  
 Dr. Daniel P. Johnson  
 Martin Greenspan  
 John D. Ramboz  
 Arnold Wexler  
 Roscoe L. Bloss  
 Dr. Robert S. Marvin  
 Fillmer W. Ruegg  
 Dr. Gershon Kulin  
 Philip S. Klebanoff
- Dr. Ralph P. Hudson  
 Dr. Harvey Marshak (Acting)  
 Dr. Max Klein  
 Dr. Raymond D. Mountain  
 Dr. Peter L. Heydemann (Acting)  
 Dr. Harmon H. Plumb  
 Dr. Henry J. Kostkowski
- Dr. Karl G. Kessler  
 Dr. John A. Simpson (Acting)  
 Dr. William C. Martin, Jr.  
 Dr. Arthur G. Maki  
 Dr. Robert P. Madden  
 Dr. Jon T. Hougren  
 Dr. Chris E. Kuyatt (Acting)  
 Dr. Richard D. Deslattes  
 Dr. Wolfgang L. Wiese  
 Stanley Ruthberg
- Bascom W. Birmingham  
 Dr. H. Alastair Gebbie  
 Richard N. Thomas  
 Dr. Thomas M. Flynn  
 Roy W. Stockwell, Jr.
- Dr. Harold S. Boyne  
 Dr. L. Yardley Beers  
 Thomas W. Russell  
 Dr. Robert J. Mahler  
 Dr. Donald A. Jennings  
 Dr. Karl B. Persson
- Dr. Raymond C. Sangster  
 Harvey W. Lance  
 Dr. Helmut M. Altschuler  
 Robert W. Beatty  
 Dr. David M. Kerns  
 Myron C. Selby  
 Eldred C. Wolzien

- |             |   |                               |
|-------------|---|-------------------------------|
| .23         | HF Impedance Standards                  | Leslie E. Huntley             |
| .24         | RF Transmission and Noise               | Charles M. Allred             |
| .25         | RF Power and Voltage                    | Paul A. Hudson                |
| .31         | Microwave Calibration Services          | Roy E. Larson                 |
| .32         | Microwave Circuit Standards             | Dr. George E. Schafer         |
| .42         | Electromagnetic Fields Standards        | Dr. Ramon C. Baird            |
| <b>*273</b> | <b>TIME AND FREQUENCY</b>               |                               |
|             | Assistant Chief                         | Dr. James A. Barnes           |
|             | Consultant                              | Roger E. Beehler              |
|             | Consultant                              | R. Lowell Fey                 |
| .01         | Frequency-Time Dissemination Research   | Dr. George E. Hudson          |
| .02         | Frequency-Time Broadcast Services       | James L. Jespersen            |
| .04         | Atomic Frequency-Time Standards         | Peter P. Viezbicke            |
|             |   | Dr. Donald W. Halford         |
| <b>*274</b> | <b>LABORATORY ASTROPHYSICS</b>          |                               |
|             |   | Dr. Stephen J. Smith (Acting) |
| <b>*275</b> | <b>CRYOGENICS</b>                       |                               |
|             | Associate Chief                         | Dudley B. Chelton             |
|             | Consultant                              | Dr. Richard H. Kroppschot     |
| .01         | Cryogenic Technical Services            | Alan F. Schmidt               |
| .02         | Cryogenic Data Center                   | Jesse Hord (Acting)           |
| .03         | Cryogenic Properties of Solids          | Victor J. Johnson             |
| .04         | Properties of Cryogenic Fluids          | Dr. Robert L. Powell          |
| .05         | Cryogenic Systems                       | Dwain E. Diller               |
| .06         | Cryogenic Metrology                     | Robert W. Arnett              |
| .07         | Cryogenic Fluid Transport Processes     | Douglas B. Mann               |
| .08         | Cryoelectronics                         | Raymond V. Smith              |
|             |   | Dr. Robert A. Kamper          |
| <b>*281</b> | <b>ADMINISTRATIVE SERVICES</b>          |                               |
| .01         | Supply                                  | Barton F. Betts               |
| .02         | Office Services                         | J. S. Roettenbacher           |
|             |   | Richard G. Bulgin             |
| <b>*282</b> | <b>INSTRUMENT SHOPS</b>                 |                               |
|             | Consultant-Engineering                  | William A. Wilson             |
| .01         | Instrument Shop 1                       | Jay N. Edmondson              |
| .02         | Instrument Shop 2                       | Vernon E. Hill                |
| .03         | Welding-Sheet Metal                     | Henry C. Leistner             |
| .04         | Glass Blowing Shop                      | James H. McCarron             |
|             |   | H. L. Hoyt                    |
| <b>*283</b> | <b>PLANT</b>                            |                               |
|             | Consultant                              | Edgar A. Yuzwiak              |
| .01         | Construction-Maintenance                | G. C. Hahn                    |
| .02         | Special Services                        | Robert W. Eddy                |
| .03         | Custodial Services                      | William D. Hitchcock          |
|             |   | Wilmer L. Schweikert          |
| <b>300</b>  | <b>INSTITUTE FOR MATERIALS RESEARCH</b> |                               |
|             | Director                                | Dr. John D. Hoffman           |
|             | Institute Scientists                    | Dr. John I. Lauritzen         |
|             |   | Dr. Robert J. Rubin           |
|             | Special Scientific Assistants           | Dr. John L. Torgesen          |
|             |   | H. Thomas Yolken              |
|             | Statistical Consultant                  | Dr. John Mandel               |

- 302 OFFICE OF STANDARD REFERENCE MATERIALS**  
 Inorganic Standards Coordinator  
 Metal Standards Coordinator  
 Organic Standards Coordinator  
 Assistant for Technical Liaison
- Joseph P. Cali (Acting)  
 John L. Hague  
 Robert E. Michaelis  
 Thomas W. Mears  
 Hugh F. Beeghly
- 310 ANALYTICAL CHEMISTRY**  
 Consultant  
 .01 Radiochemical Analysis  
 .02 Spectrochemical Analysis  
 .03 Electrochemical Analysis  
 .04 Analytical Coordination Chemistry  
 .05 Microchemical Analysis  
 .06 Analytical Mass Spectrometry  
 .07 Organic Chemistry  
 .08 Activation Analysis  
 .09 Separation and Purification
- Dr. W. Wayne Meinke  
 Dr. Charles P. Saylor  
 Dr. James R. DeVoe  
 Bourdon F. Scribner  
 Dr. Roger G. Bates  
 Dr. Oscar Menis  
 Dr. John K. Taylor  
 William R. Shields  
 Dr. Robert Schaffer  
 Dr. Philip D. LaFleur  
 Dr. David H. Freeman
- 311 POLYMERS**  
 Deputy Chief  
 Consultant on Rubber and Polymers  
 .01 Polymer Dielectrics  
 .02 Polymer Chemistry  
 .03 Polymer Crystal Physics  
 .04 Molecular Properties  
 .05 Dental Research  
 .06 Polymer Characterization  
 .07 Polymer Interfaces  
 .08 Thermophysical Properties
- Dr. Ronald K. Eby  
 Dr. Robert R. Stromberg  
 Dr. Lawrence A. Wood  
 Dr. Martin G. Broadhurst  
 Dr. Leo A. Wall  
 Dr. Darrell H. Reneker  
 Dr. Peter H. Verdier (Acting)  
 Dr. James M. Cassel  
 Dr. Peter H. Verdier (Acting)  
 Dr. Robert R. Stromberg  
 Dr. Martin G. Broadhurst (Acting)
- 312 METALLURGY**  
 .01 Engineering Metallurgy  
 .02 Alloy Physics  
 .03 Lattice Defects and Microstructures  
 .04 Corrosion  
 .05 Metal Physics  
 .06 Electrolysis and Metal Deposition  
 .07 Crystallization of Metals
- Dr. Elio Passalia  
 Glenn W. Geil (Acting)  
 Dr. Lawrence H. Bennett  
 Dr. A. William Ruff, Jr.  
 Dr. Jerome Kruger  
 Dr. John R. Manning  
 Dr. Abner Brenner  
 Dr. Robert L. Parker
- 313 INORGANIC MATERIALS**  
 Consultant  
 Consultant  
 Consultant  
 Consultant  
 Consultant  
 .01 Inorganic Chemistry  
 .02 Inorganic Glass  
 .03 High Temperature Chemistry  
 .05 Physical Properties  
 .06 Crystallography  
 .07 Solid State Physics
- Dr. John B. Wachtman, Jr.  
 Dr. Arthur I. Bienenstock  
 Dr. Gilbert Gordon  
 Dr. Ellis R. Lippincott  
 Dr. Howard F. McMurdie  
 Dr. James M. Stewart  
 Dr. Thomas D. Coyle  
 Dr. Wolfgang Haller  
 Dr. Thomas D. Coyle (Acting)  
 Dr. Sheldon H. Wiederhorn  
 Dr. Stanley Block  
 Dr. Hans P. R. Frederikse

- 316 PHYSICAL CHEMISTRY**  
 Assistant Chief  
 Consultant  
 Research Chemist  
 .11 Thermochemistry  
 .21 Surface Chemistry  
 .51 Elementary Processes  
 .52 Mass Spectrometry  
 .53 Photo Chemistry  
 .54 Radiation Chemistry
- Dr. James R. McNesby (Acting)  
 Dr. Arnold M. Bass  
 Edward J. Prosen  
 Blanton C. Duncan  
 Dr. George T. Armstrong  
 Dr. Ralph Klein  
 Dr. David Garvin  
 Dr. Henry M. Rosenstock  
 Dr. Milton D. Scheer  
 Dr. Pierre J. Ausloss

**INSTITUTE FOR APPLIED TECHNOLOGY**

- Director  
 Deputy Director  
 .01 Fire Research and Safety Office  
 .02 Office of Flammable Fabrics
- Dr. Howard E. Sorrows (Acting)  
 Malcolm W. Jensen (Acting)  
 Dr. John A. Rockett  
 Dr. Elio Passaglia (Acting)
- 403 OFFICE OF ENGINEERING STANDARDS SERVICES**  
 .01 Product Standards  
 .02 Information  
 .03 Mandatory Standards
- Donald R. MacKay  
 Herbert A. Philo  
 William J. Slattery (Acting)  
 Donald R. MacKay (Acting)
- 404 OFFICE OF WEIGHTS AND MEASURES**  
 Assistant Chief
- Thomas M. Stabler (Acting)  
 Harold F. Wollin
- 406 OFFICE OF INVENTION AND INNOVATION**  
 .01 Innovation Studies Program  
 .02 Invention Programs  
 .03 Engineering Education Program  
 .04 Manager, Metric Study Program
- Daniel V. DeSimone  
 Joseph D. Crumlish  
 Leonard S. Hardland  
 John M. Tascher  
 Alvin G. McNish
- 408 OFFICE OF VEHICLE SYSTEMS RESEARCH**  
 Deputy Chief  
 .01 Tire Systems  
 .02 Occupant Restraint Systems  
 .03 Braking Systems
- Paul J. Brown  
 Dr. F. Cecil Brenner (Acting)  
 Dr. F. Cecil Brenner  
 Richard W. Armstrong  
 Robert J. Forthofer
- 411 PRODUCT EVALUATION**  
 Consultant  
 .01 Plastics and Textiles  
 .02 Fibrous Systems  
 .03 Viscoelastic Materials  
 .04 Paper Evaluation
- Dr. Melvin R. Meyerson (Acting)  
 Dr. Robert D. Stiehler  
 Karl F. Plitt  
 Donald G. Fletcher  
 George E. Decker (Acting)  
 William K. Wilson
- 421 BUILDING RESEARCH**  
 Deputy Chief  
 .01 Structures  
 .02 Fire Research  
 .04 Materials Durability and Analysis  
 .05 Codes and Standards  
 .06 Building Systems  
 .07 Scientific and Professional Liaison  
 .10 Sensory Environment Branch  
 .11 Environmental Engineering  
 .12 Psychophysics  
 .13 Building Transport Systems
- Dr. James R. Wright  
 Harry E. Thompson  
 Dr. Edward O. Pfrang  
 Irwin A. Benjamin  
 William C. Cullen  
 Gene A. Rowland  
 Robert W. Blake  
 James L. Haecker  
 Paul R. Achenbach  
 Frank J. Powell  
 John F. Halldane  
 Paul R. Achenbach (Acting)

- 425 **ELECTRONIC TECHNOLOGY**
  - Assistant to Chief
  - Consultant
  - .01 Semiconductor Characterization
  - .02 Electron Devices
  - .03 Instrumentation Applications
  - .04 Semiconductor Processing
  
- 431 **TECHNICAL ANALYSIS**
  - Deputy Chief for Project Operations
  - Deputy Chief for Quality Control
  - Socio-Economic Studies
  - Simulation and Transportation Studies
  - Operations Research in Behavioral Science
  - Post Office Studies
  - Corridor Model System
  - TAD Planning and Justice Department Studies
  
- 445 **INSTRUMENT SHOPS**
  - Assistant Chief
  - .01 Instrument Shop #1
  - .02 Instrument Shop #2
  - .03 Instrument Shop #3
  - .04 Instrument Shop #4
  - .05 Instrument Shop #5
  - .06 Glassblowing
  - .07 Welding and Sheet Metal Shop
  - .08 Optical Shop
  - .09 Tool Crib
  - .10 Electroplating
  
- 446 **MEASUREMENT ENGINEERING**
  - .01 Electronic Instrumentation
  - .02 Electronic Optical Development
  - .03 Microwave and Mechanical Instrumentation
  
- 500 **CENTER FOR RADIATION RESEARCH**
  - Director
  - Deputy Director
  - .01 Radiation Theory
  - .02 Health Physics
  
- 501 **REACTOR RADIATION**
  - .01 Reactor Operations
  - .02 Engineering Services
  - .03 Neutron Solid-State Physics
  - .04 Radiation Effects
  
- 502 **LINAC RADIATION**
  - .01 Linac Operations
  - .02 Radiation Physics Instrumentation
  - .03 Photonuclear Physics
  - .04 Electronuclear Physics

Myron G. Domsitz  
 Gustave Shapiro  
 Charles P. Marsden  
 Dr. W. Murray Bullis  
 Judson C. French  
 Joshua Stern  
 Dr. Joseph A. Coleman

Dr. W. Edward Cushen  
 Abraham E. Karp  
 Dr. George Suzuki  
 Dr. George Suzuki (Acting)  
 Louis C. Santone  
 Dr. June R. Cornog  
 William F. Druckenbrod  
 Ralph E. Schofer  
 John W. Locke

Frank P. Brown  
 Winfield L. Drissel  
 Earl L. Schwenk  
 Walter A. Koepper  
 Charles E. Taylor  
 Phillip Pfaff, Jr.  
 John R. Pidgeon  
 Enrico Deleonibus  
 Harold E. Brown  
 Stanley W. Gerner  
 Herbert Robinson (Acting)  
 Frank P. Brown (Acting)

G. Franklin Montgomery  
 Robert J. Carpenter  
 M. Leighton Greenough  
 Robert O. Stone

Dr. Carl O. Muehlhause  
 Dr. Randall S. Caswell  
 Dr. Martin J. Berger  
 Dr. Abraham Schwebel

Dr. Robert S. Carter  
 Tawfik M. Raby (Acting)  
 John H. Nicklas  
 Dr. Robert S. Carter  
 Vacant

Dr. James E. Leiss  
 Dr. James E. Leiss  
 Louis Costrell  
 Dr. Everett G. Fuller  
 Dr. Samuel Penner

<b>503</b>	<b>NUCLEAR RADIATION</b>	
	.01 Neutron Physics	Dr. Harry H. Landon
	.02 Radioactivity	Dr. Harry H. Landon
	.03 Nuclear Spectroscopy	Dr. Wilfred B. Mann Dr. Raymond W. Hayward
<b>504</b>	<b>APPLIED RADIATION</b>	
	.01 X-ray Physics	Dr. Joseph W. Motz
	.02 Dosimetry	Dr. Joseph W. Motz Dr. Robert Loevinger
<b>600</b>	<b>CENTER FOR COMPUTER SCIENCES AND TECHNOLOGY</b>	
	Director	Dr. Herbert R. J. Grosch
	Consultant	Mary Elizabeth Stevens
	Consultant	Madeline B. Henderson
	.10 Manager-Pattern Recognition and Description Program	Joseph H. Wegstein
<b>610</b>	<b>OFFICE OF INFORMATION PROCESSING STANDARDS</b>	
	.01 Planning and Coordination	Dr. Joseph O. Harrison, Jr. Vacant
	.02 Hardware Standards	Vacant
	.03 Software Standards	Vacant
	.04 Applications and Data Standards	Vacant
	.05 ADP Management Standards	Vacant
<b>620</b>	<b>OFFICE OF COMPUTER INFORMATION</b>	Margaret R. Fox
<b>630</b>	<b>COMPUTER SERVICES</b>	
	Assistant Chief	W. Bruce Ramsay
	.01 Business Applications	Loretta M. Allison
	.02 Scientific Applications	Martin R. Shaver
	.03 Computer Operations	Dr. Robert J. Arms
	.04 Systems Programming and Training	Peter J. O'Hara Dr. Robert J. Arms (Acting)
<b>640</b>	<b>SYSTEMS DEVELOPMENT</b>	
	.01 Programing Research	Charles T. Meadow
	.02 Information Science	Charles T. Meadow (Acting)
	.03 Management Systems	Dr. Stephen J. Tauber
	.04 Instructional Systems	John F. Wood Charles T. Meadow (Acting)
<b>650</b>	<b>INFORMATION PROCESSING TECHNOLOGY</b>	
	.01 Measurements Automation	James P. Nigro
	.02 Computer Systems	Raymond T. Moore
	.03 Performance Measurements	Thomas N. Pyke, Jr. Arthur A. Ernst

\* Laboratories located in Boulder, Colorado.

#### FIELD STATIONS

Visual Landing Aids Laboratory, Arcata, CA  
 U.S. Joint Publications Research Service, San Francisco, CA  
 Scientific Observations and Measurements Site, Poor Man's Mine, Four Mile Canyon, Boulder, CO  
 Standard Frequency Stations WWVB/WWVL, Fort Collins, CO  
 Radio Propagation and Standard Frequency Station WWVH, Puunene, Maui, HA  
 Master Railway Track Scale Depot, Clearing, IL  
 U.S. Joint Publications Research Service, New York, NY

---

**APPENDIX J**

---

**SITE INFORMATION AND MAPS  
GAITHERSBURG AND BOULDER**



**BUILDINGS AND STRUCTURES OF THE NATIONAL BUREAU OF STANDARDS**

**GAITHERSBURG, MARYLAND**

**1970**

Building	Name	Year Construction		Occupancy Date (in operation)	Assignable Square Feet
		Begun	Completed		
101	Administration	6-18-62	7-12-65	7-12-65	308,493
102	Gate House	5-1-69	3-1-70	2-19-70	170
202	Engineering Mechanics	7-19-61	10-1-63	6-1-63	46,111
206	Concreting Materials	3-1-66	3-1-68	3-1-68	5,418
220	Metrology	8-21-63	2-14-66	2-14-66	109,130
221	Physics	8-21-63	3-28-66	3-28-66	111,505
222	Chemistry	8-21-63	2-28-66	2-28-66	79,496
223	Materials	8-21-63	4-27-66	4-27-66	78,060
224	Polymers	8-21-63	6-6-66	6-6-66	78,597
225	Instrumentation	8-21-63	8-3-66	8-3-66	104,621
226	Building Research	8-21-63	10-3-66	9-8-66	64,388
230	Fluid Mechanics	6-1-67	6-1-69	6-1-69	50,080
231	Industrial	2-8-66	2-8-68	2-8-68	40,615
233	Sound	9-20-65	2-27-68	2-27-68	21,247
235	Reactor	4-25-63	8-23-65	8-23-65	61,086
236	Hazards	4-15-66	4-15-68	5-15-68	6,505
237, 238	Non-Magnetic	6-3-64	2-14-68	2-14-68	4,352
245	Radiation	6-18-62	8-20-65	4-15-64	88,104
301	Supply & Plant	6-18-62	10-15-64	10-15-64	103,807
302	SCWGP	7-19-61	7-21-64	4-1-63	27,551
303	Service	6-18-62	5-4-64	5-4-64	12,262
304	Instrument	6-18-62	12-4-64	12-4-64	53,552
305	Cooling Tower	7-19-61	7-21-64	-----	-----
306	Electrical Substation	7-19-61	1-2-64	4-1-63	-----
308	Bowman House*	1-1-52	1-1-53	5-15-69	3,826

TOTAL 1,352,843

Main Site Land - 575 acres

Date Acquired: August 1958 to May 1970

\*Existing Structure

Dates are approximate

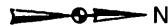
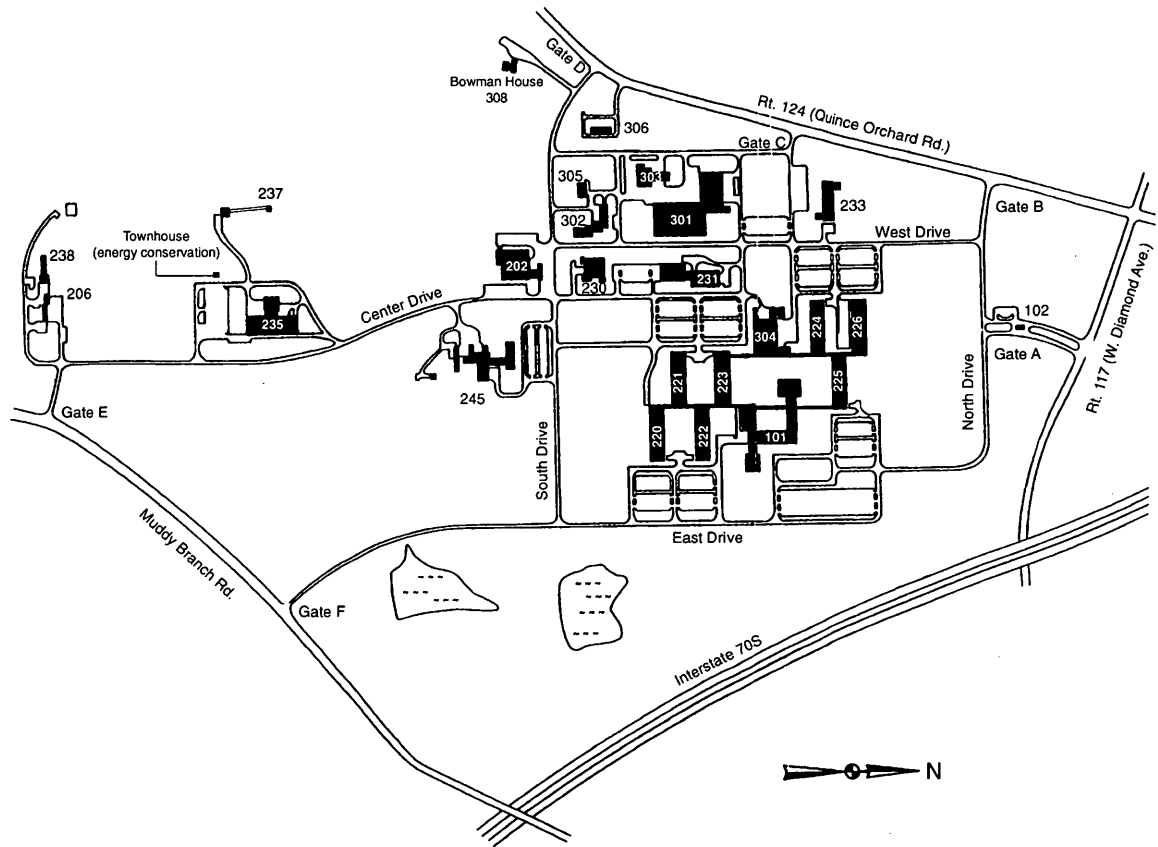

**BUILDINGS AND STRUCTURES OF THE NATIONAL BUREAU OF STANDARDS**

**BOULDER, COLORADO**

**1970**

Building	Name	Date (in operation)	Assignable Square Feet
B1	Radio Building: Library, Auditorium, Center Spine, Wing 1, Wing 2, Wing 3, Wing 4	1954	200,257
B1	Wing 5	1962	77,928
B1	Wing 6	1959	26,000
B2	Cryogenics, South and North Half	1952	45,702
B2	Cryogenics, Wing "B"	1962	9,800
B3	Liquefier	1952	20,024
B4	Camco	1951	15,403
B5	Heavy Equipment	1951	2,850
B8	Cryogenic Mesa Test Site	1953	2,400
B9	Gas Meter	1958	312
B10	Green Mountain Antenna Building	1958-1973	209
B11	Vertical Incidence	1958	408
B14	Field Strength Calibration	1958	278
B17	Hydrogen Storage Tanks		
B18	Tube Tanks (Hydrogen) Storage		
B21	Maintenance Garage	1963	3,968
B22	Warehouse	1964	17,280
B23	Cooling Tower	1957-1989	312
B24	Plasma Physics <sup>1</sup>	1967	27,328
B25	North Shop	1966	3,200
B26	Ground Scanner Site		
B27	High Frequency Field Site		
B28	Microwave Antenna Range		
<b>TOTAL</b>			<b>453,659</b>

Main Site Land: 217 acres  
Date Acquired: June 14, 1950

<sup>1</sup> Used by the Environmental Science Services Administration.



This page intentionally left blank

---

## BIBLIOGRAPHIC NOTE AND REFERENCES

---

### SOURCES:

#### NBS/NIST Publications

A list of Bureau publications and their history is given in Appendix H. Detailed information about individual publications is provided in NBS Circular 460 and supplement (1901–1957), NBS Miscellaneous Publication 240 and supplement (1957–1966), and NBS/NIST Special Publication 305 and supplements (1966 to the present). A complete set of Bureau publications, with the exception of the NBS Reports (graybacks), is kept in the NIST Library. The reports are located at the National Archives in College Park, Maryland.

The Bureau's Annual Reports were used to provide a framework for the technical work discussed in the chapters. These reports, with various titles as listed in Appendix H, are complete except for the war years 1943–1945, when as an economy measure, the reports were sent in manuscript form to the secretary of commerce.

#### Other Government Documents

The annual hearings before the House Subcommittee dealing with appropriations for the Department of Commerce were used extensively to provide information on budget, personnel, program, renovation, and construction requests. Other House and Senate hearings and reports provided documentation in specific instances of Bureau history or science-in-general in the Federal Government. Publications of other agencies of the Federal Government were also valuable sources for material relevant to the work of the Bureau.

#### Background

Histories of world science, American social life, and the political climate set the scene for each chapter and put the work of the Bureau into proper context. Handbooks, textbooks, and technical papers and reports were studied and cited. Interviews with current and former NBS/NIST staff were recorded and extensive use of oral histories in the NIST Library collection were reviewed. Local and national newspapers were consulted, particularly in controversial cases such as the AD-X2 affair and E.U. Condon's resignation.

#### Unpublished

The National Archives and Records Administration, repository for the record copy of NBS/NIST documents in Record Group 167, provided a rich source of information in the correspondence files of the director. At NIST, the director's files, consisting of the director's correspondence that comprises the working files of the Director's Office, were made available and provided information for the later chapters. Another useful source was the general records of the Department of Commerce. These records, although inactive, were located at the department.

The archives of the American Philosophical Society in Philadelphia provided a wealth of information about the ordeal of E. U. Condon with the House Committee on Un-American Activities.

#### Abbreviations in Footnotes

Certain abbreviations and shortened forms of titles are used in the footnotes. MFP is *Measures for Progress* by Rexmond C. Cochran; Annual Report is one of the many NBS annual report titles listed in Appendix H; NARA is the National Archives and Records Administration, repository of NBS/NIST official records; DOC is the Department of Commerce; NIST RHA denotes the official records kept in the NIST Records Holding Area until they are sent to the Federal Records Center in Suitland, MD; and the History Project File kept for this history, and the NIST History File are located in the NIST Library. Other abbreviations used are explained where appropriate.

### SELECTED REFERENCES:

Achenbach, Paul R. *Building Research at the National Bureau of Standards*, Natl. Bur. Stand. (U.S.) Building Science Series 0. Washington, D.C.: National Bureau of Standards, U.S. Dept. of Commerce, 1970.

National Bureau of Standards. Annual Reports, FY 1902—FY 1985. Title varies, see Appendix H.

- Beal, Karma A., ed. *NBS/NIST, A Historical Perspective, A Symposium in Celebration of NIST's Ninetieth Anniversary, March 4, 1991*. Natl. Inst. Stand. Technol. (U.S.) Special Publication 825. Washington, D.C.: National Bureau of Standards, U.S. Dept. of Commerce, 1992.
- Briggs, Lyman J. *NBS War Research: The National Bureau of Standards in World War II*. Washington, D.C.: National Bureau of Standards, U.S. Dept. Of Commerce, 1949.
- Broder, David. *The Party's Over: The Failure of Politics in America*. New York: Harper and Row, 1972.
- . *Behind the Front Page*. New York: Simon and Schuster, 1987.
- Burns, James MacGregor. *The Crosswinds of Freedom: From Roosevelt to Reagan—America in the Last Half Century*. New York: Vintage Books, 1990.
- Bush, Vannevar. *Science, the Endless Frontier: a Report to the President on a Program for Postwar Scientific Research. 1945*. Reprint, Washington, D.C.: National Science Foundation, 1960.
- Carr, Robert K. *The House Committee on Un-American Activities*. Ithaca, NY: Cornell University Press, 1952.
- Caro, Robert A. *The Years of Lyndon Johnson: The Path to Power*. New York: Knopf, 1982.
- Cochrane, Rexmond C. *Measures for Progress: A History of the National Bureau of Standards*. Natl. Bur. Stand. (U.S.) Miscellaneous Publication 275. Washington, D.C.: National Bureau of Standards, U.S. Dept. of Commerce, 1966.
- Condon, E. U. "Reminiscences of a Life In and Out of Quantum Mechanics." *International Journal of Quantum Chemistry*. Symposium no. 7. (1973): 7-22.
- Diggins, John Patrick. *The Proud Decades: America in War and Peace, 1941-1960*. New York: W. W. Norton, 1988.
- Doctorow, E. L. *Ragtime*. New York: Random House, 1974.
- Drew, Elizabeth. *Politics and Money: The New Road to Corruption*. New York: Macmillan, 1983.
- Essers, Florence, and Jacob Rabinow, eds. *The Public Need and Role of the Inventor: Proceedings of a Conference held in Monterey, California, June 11-14, 1973*. Natl. Bur. Stand. (U.S.) Special Publication 388. Washington, D.C.: National Bureau of Standards, U.S. Dept. of Commerce, 1974.
- Fullbright, J. William. *The Arrogance of Power*. New York: Random House, 1966.
- Goldman, Eric F. *The Crucial Decade—and After: America, 1945-1960*. New York: Vintage Books, 1960.
- Goodman, Walter. *The Committee: The Extraordinary Career of the House Committee on Un-American Activities*. New York: Farrar, Straus, and Giroux, 1968.
- Hellemans, Alexander, and Bryan Bunch. *The Timetables of Science*. New York: Simon and Schuster, 1988.
- Hestenes, Magnus R., and John Todd. *NBS-INA—The Institute for Numerical Analysis—UCLA 1947-1954*. Natl. Inst. Stand. Technol. (U.S.) Special Publication 730. Washington, D.C.: National Bureau of Standards, U.S. Dept. of Commerce, 1991.
- Huskey, Harry D. "The National Bureau of Standards Western Automatic Computer (SWAC)." *Annals of the History of Computing* 2, no. 2 (1980): 111-121.
- . "The SWAC, The National Bureau of Standards Western Automatic Computer." In *A History of Computing in the Twentieth Century*. New York: Academic Press, 1980: 419-431.
- Jespersion, James, and Jane Fitz-Randolph. *From Sundials to Atomic Clocks*. Natl. Bur. Stand. (U.S.) Monograph 155. Washington, D.C.: National Bureau of Standards, U.S. Dept. of Commerce, 1977.
- Johnson, Paul. *Modern Times: The World from the Twenties to the Eighties*. New York: Perennial Library, 1985.
- Katz, James Everett. *Presidential Politics and Science Policy*. New York: Praeger, 1978.
- Keith, Caroline H. *For Hell and a Brown Mule: The Biography of Senator Millard E. Tydings*. Lanham, MD: University Press of America, 1990.
- Kelvin, William Thomson, 1st Baron. *Popular Lectures and Addresses*, v. 1, *Constitution of Matter*, 2nd ed. London: Macmillan, 1891.
- Kevles, Daniel J. 1987. *The Physicists: The History of a Scientific Community in Modern America*. Cambridge, MA: Harvard University Press, 1987.

- Kimberly, Arthur E., and Bourden W. Scribner. *Summary Report of Bureau of Standards on Preservation of Records*. Natl. Bur. Stand. (U.S.) Miscellaneous Publication 154. Washington, D.C.: National Bureau of Standards, U.S. Dept. of Commerce, 1937.
- Lambricht, W. Henry. *Presidential Management of Science and Technology: The Johnson Presidency*. Austin: University of Texas Press, 1985.
- Lawrence, Samuel A. *The Battery Additive Controversy*. University, AL: University of Alabama Press, 1962.
- Lemann, Nicholas. *The Promised Land: The Great Black Migration and How it Changed America*. New York: Alfred A. Knopf, 1991.
- Lomask, Milton. *A Minor Miracle: An Informal History of the National Science Foundation*. Washington, D.C.: National Science Foundation, 1976.
- Mackay, Donald R., ed. *A Glossary of Standards-Related Terminology*. Natl. Inst. Stand. Technol. (U.S.) NISTIR 89-4194. Washington, D.C.: National Institute of Standards and Technology, U.S. Dept. of Commerce, 1989.
- Magnuson, Warren G., and Jean Carper. *The Dark Side of the Marketplace: The Plight of the American Consumer*. Englewood Cliffs, NJ: Prentice-Hall, 1968.
- Manchester, William. *The Glory and the Dream: A Narrative History of America, 1939-1972*. Boston: Little, Brown, 1974.
- May, Elaine Tyler. *Homeward Bound: American Families in the Cold War Era*. New York: Basic Books, 1988.
- Nadel, Mark V. *The Politics of Consumer Protection*. Indianapolis: Bobbs-Merrill, 1971.
- National Academy of Sciences (U.S.). Ad Hoc Committee for the Evaluation of the Present Functions of the National Bureau of Standards. *A Report to The Secretary of Commerce by the Ad Hoc Committee for the Evaluation of the Present Functions of the National Bureau of Standards: A Report on the Present Functions and Operations of the National Bureau of Standards with Their Evaluation in Relation to Present National Needs and Recommendations for the Improvement and Strengthening of the Bureau*. Washington, D.C.: National Academy of Sciences, 1953.
- National Academy of Sciences (U.S.). Committee on Battery Additives. *Report of the Committee on Battery Additives of the National Academy of Sciences*. Washington, D.C.: National Academy of Sciences, 1953.
- National Academy of Sciences (U.S.). Special Advisory Committee. *The Role of the Department of Commerce in Science and Technology: A Report to the Secretary of Commerce by a Special Advisory Committee of the National Academy of Sciences*. Washington, D.C.: National Academy of Sciences, 1960.
- National Science Foundation (U.S.). *Organization of the Federal Government for Scientific Activities*. Washington, D.C.: National Science Foundation, 1956.
- Newhouse, John. *War and Peace in the Nuclear Age*. New York: Knopf, 1989.
- Nixon, Richard M. *Six Crises*. Garden City, NY: Doubleday, 1969.
- O'Neill, William L. *American High: The Years of Confidence, 1945-1960*. New York: The Free Press, 1986.
- Page, Chester H., and Paul Vigoureux, eds. *The International Bureau of Weights and Measures, 1875-1975*. Natl. Bur. Stand. (U.S.) Special Publication 420. Washington, D.C.: National Bureau of Standards, U.S. Dept. of Commerce, 1975.
- Pais, Abraham. *Inward Bound: Of Matter and Forces in the Physical World*. Oxford: Clarendon Press, 1986.
- Passaglia, Elio. *Science: Evidence, Truth & Integrity*. Natl. Bur. Stand. (U.S.) Special Publication 690. Washington, D.C.: National Bureau of Standards, U.S. Dept. of Commerce, 1985.
- Perry, John. *The Story of Standards*. New York: Funk & Wagnalls, 1955.
- Price, Don K. *Government and Science: Their Dynamic Relationship in American Democracy*. New York: New York University Press, 1954.
- Reedy, George E. *The Twilight of the Presidency from Johnson to Reagan*. New York: New American Library, 1987.



- Schlesinger, Arthur M., Jr. *A Thousand Days: John F. Kennedy in the White House*. Boston: Houghton Mifflin, 1965.
- . *The Cycles of American History*. Boston: Houghton Mifflin, 1986.
- Shapely, Deborah, and Rustum Roy. *Lost at the Frontier*. Philadelphia: ISI Press, 1985.
- Smith, Bruce L. R. *American Science Policy Since World War II*. Washington, D.C.: The Brookings Institution, 1990.
- Smith, Ralph W. *The Federal Basis for Weights and Measures*. Natl. Bur. Stands. (U.S.) Circular 593. Washington, D.C.: National Bureau of Standards, U.S. Dept. of Commerce, 1958.
- Smyth, Henry D. *Atomic Energy for Military Purposes, the Official Report on the Development of the Atomic Bomb Under the Auspices of the United States Government, 1940-1945*. Princeton: Princeton University Press, 1945.
- Snyder, Wilbert F., and Charles L. Bragaw. *Achievement in Radio: Seventy Years of Radio Science, Technology, Standards, and Measurement at the National Bureau of Standards*. Natl. Bur. Stands. (U.S.) Special Publication 555. Washington, D.C.: National Bureau of Standards, U.S. Dept. of Commerce, 1986.
- Stone, I. F. *The Haunted Fifties: 1952-1963*. Boston: Little Brown, 1963.
- Taylor, Barry N. *Guide for the Use of the International System of Units (SI)*. Natl. Inst. Stand. Technol. (U.S.) Special Publication 811, 1995 ed. Washington, D.C.: National Institute of Standards and Technology, 1995.
- Taylor, Barry N. and Chris E. Kuyatt. *Guidelines for Evaluating and Expressing the Uncertainty of NIST Measurement Results*. Natl. Inst. Stand. Technol. (U.S.) Technical Note 1297, 1994 ed. Washington, D.C.: National Institute of Standards and Technology, 1994.
- Taylor, Lauriston S. *X-Ray Measurements and Protection, 1913- 1964: The Role of the National Bureau of Standards and the National Radiological Organizations*. Natl. Bur. Stand. (U.S.) Special Publication No. 625. Washington, D.C.: National Bureau of Standards, U.S. Dept. of Commerce, 1981.
- Todd, John. "John Hamilton Curtiss, 1909-1977." *Annals of the History of Computing* 2, no. 2 (1980): 104-110.
- Trager, James. *The People's Chronology*. New York: Holt, Rinehart, and Winston, 1979.
- Tuchman, Barbara. *The March of Folly: From Troy to Vietnam*. London: Cardinal, 1990.
- Unesco. *National Science Policies of the U.S.A.: Origins, Development and Present Status*. Paris, Unesco, 1968.
- United States. Bureau of Standards. *War Work of the Bureau of Standards*. Natl. Bur. Stand. (U.S.) Miscellaneous Publication 46. Washington, D.C.: National Bureau of Standards, U.S. Dept. of Commerce, 1921.
- United States. Congress. Senate. Select Committee on Small Business. *Battery AD-X2. Hearings Before the Select Committee on Small Business, United States Senate, Eighty-third Congress, First Session, on Investigation of Battery Additive AD-X2, March 31, June 22, 23, 24, 25, and 26, 1953*.
- . *Annual Report of the Select Committee on Small Business, U.S. Senate*, 25 March 1954.
- United States. Library of Congress. Legislative Reference Service. "AD-X2: The Difficulty of Proving a Negative." Chapter 3 in *Technical Information for Congress: Report to the Subcommittee on Science, Research, and Development of the Committee on Science and Astronautics, U.S. House of Representatives, 91st Cong., 1st sess.* 1969.
- United States. National Bureau of Standards. *Preservation of the Declaration of Independence and the Constitution of the United States of America*. Natl. Bur. Stand. (U.S.) Circular 505. Washington, D.C.: National Bureau of Standards, U.S. Dept. of Commerce, 1951.
- United States. National Bureau of Standards. *Report on Battery Additives by the National Bureau of Standards*. Natl. Bur. Stand. (U.S.) Report 2447. Washington, D.C.: National Bureau of Standards, U.S. Dept. of Commerce, 1953.
- Weber, Gustavus A. *The Bureau of Standards: Its History, Activities and Organization*. Baltimore: Johns Hopkins Press, 1925.

---

## INDEX

---

This index is arranged word by word. Letters and numbers are sorted up to the end of the first word or comma, and then stop. All other characters are sorted as a space. The second and following words are sorted only when two or more entries begin with the same word. Page numbers followed by an "n" indicate the information is found in a footnote. **Bold** page numbers indicate photographs.

### A

- Abramowitz, Milton, 264  
absolute ampere, 197–200  
absolute measurements, 197  
absolute radiometer, 545  
absolute units, 537–538  
acceptance testing, 226, 283, 284  
Achenbach, Paul R., 253n, 591  
Acheson, Dean, 5  
acidity standards, 220–221  
acoustic impedance, 229  
acrylic aircraft canopies, 233  
Activation Analysis Section, 569  
Ad-Hoc Cryogenic Engineering Panel, 308n  
AD-X2. *See* Battery AD-X2  
Adams, John Quincy, 48  
Adams, Leason H., 355  
adiabatic demagnetization, 207, 210  
adiabatic furnace, 260  
Administration Building, **484**  
Advanced Research Projects Agency (ARPA),  
294, 398, 438, 582–586  
Aerodynamics Section, 226n  
Aerospace Industries Association, 377  
Agency for International Development, **384**, 509  
Agricultural Trade Development and Assistance  
Act of 1954, 303  
Agricultural University of Wageningen, The  
Netherlands, 554  
air cleaners, testing, 257  
air flow, 226, **227**, 257  
Air Navigation Development Board, 276  
air pollution, 143, 220, 293  
Air Research and Development Command, 192  
air turbulence, 226  
aircraft components, plastic, 233  
aircraft engineering, 227  
aircraft performance, 226–227  
airglow projects, 443  
Albert, Carl, **469**  
Aldrin, Edwin E., Jr., 460  
Alexander, Samuel N., 42, **43**, 261, 432, 502  
Allen, John J., Jr., 129  
Allen V. Astin Measurement Science Award, 316  
Alley, C.O., 525n, 526n  
Alloy Data Center, 429  
Alloy Physics Section, 428  
alloys, studies of, 238, 239  
*Alouette 1* satellite, 445  
Alpher, Ralph, 11  
Alt, Franz L., 262  
Aluminum Company of America, 257  
aluminum foil reflective insulation, 257  
Alvarez, Luis W., 38  
amateur radio operators, **530**  
Ambler, Ernest  
    adiabatic demagnetization research, 206, 207  
    director, Institute for Basic Standards (IBS),  
    468  
    interview with, 209  
    nonconservation of parity, 147, 207–212  
    nuclear orientation techniques, 208  
    superconducting semiconductors, **561**  
American Apparel Manufacturers Association, 337  
American Association for the Advancement of  
Science, 5, 144  
American Association of Clinical Chemistry  
(AACC), 551–552  
American Ceramic Society, 177n, 252  
American Chemical Society (ACS), 119n, 177n,  
329, 332–333  
American Crystallographic Association, 252  
American Dental Association, 33, 236  
American Foundrymen's Association, 31  
American Institute of Electrical Engineers, 119n,  
177n  
American Institute of Mining and Metallurgical  
Engineers, 119n, 177n  
American Institute of Mining, Metallurgical, and  
Petroleum Engineers, 512  
American Institute of Physics (AIP), 119n, 177n,  
332–333  
American Iron and Steel Institute, 254  
American National Standards Institute (ANSI),  
260, 559

- American Petroleum Institute, 32
- American Physical Society  
 on A.V. Astin's dismissal, 117, 120  
 Division of Electron Physics, 216  
 Donald F. Hornig's speech, 462-463  
 meetings, 70  
 NSRDS assistance, 329  
 support of E.U. Condon, 163
- American Society for Testing and Materials (ASTM)  
 as advisory committee, 177n  
 electronic materials, 438  
 National Measurement System, 512  
 silicon resistivity, 586, 588  
 Smoke Density Chamber, 598  
 standard x-ray patterns, 252
- American Society of Civil Engineers, 119n
- American Society of Mechanical Engineers, 119n, 177n
- American-Soviet Science Society (ASSS), 159, 163
- American Standards Association (ASA), 177n, 260, 559
- American University, 565
- American Window Glass Company, 52
- ammeters, calibrating, 23
- ammonia clock, 12, 368
- ammonium dihydrogen phosphate, 583, 585
- AMOS IV computer, 433, 434
- ampere, absolute, 197-200
- amyl acetate lamp, 546
- analysis of experimental data, 265
- Analysis of Material and Structural Failures Program, Metallurgy Division, 579
- Analytical and Inorganic Chemistry Division, 318, 419, 438
- analytical chemistry, 219, 580
- Analytical Chemistry Division, 343, 419-420, 521, 568, 569
- anemometers, 226, 227, 257
- angstrom, 37n
- Ångström, Anders J., 545
- anthropomorphic dummies, 498-500
- Apollo 11 mission, 460, 525, 526
- Apollo 14 mission, 525
- Apollo Program, 289
- applications standards, Center for Computer Sciences and Technology, 559
- Applied Analytical Research Section, 419
- applied mathematics, 66
- applied mathematics and computers, 40-44, 261-269, 431
- Applied Mathematics Division, 261-269, 305, 430-432, 503, 507
- Applied Mathematics Executive Council, 261
- Applied Polymers Standards and Research Section, 319
- Applied Research Award, 316
- appropriations, wartime, 30
- Aquella, 71, 74-79
- architectural acoustics, 229
- arctic radar network, 254
- Armstrong, Neil A., 287, 460
- Army Ballistic Missile Agency, 288
- Army-McCarthy hearings, 140-141
- Army Office of Ordnance Research, 206
- Army Ordnance Corps, 99
- Army Ordnance Department, 41
- Army Quartermaster Corps, 257
- Army Signal Corps, 433
- artifacts v. natural standards, 37-40
- artificial radioactivity, 56
- ASCII, 559-560
- Asphalt Roofing Industry Bureau, 257-258
- asphalt studies, 450
- assassinations, 287, 292
- Associated Advertising Clubs of the World, 83
- Association of American Battery Manufacturers, 95
- Association of American Steel Manufacturers, 31
- Astin, Alexander William, 172
- Astin, Allen V.  
 1965 Annual Report, introduction, 465  
 anniversary, fiftieth, 154  
 appointed acting director, 102  
 appointment of S.N. Alexander, 432  
 Battery AD-X2  
 correspondence with J.M. Ritchie, 106n  
 interview with, 107n  
 letter from V.P. Dalmas, 104n  
 letter to H.H. Lehman, 102  
 publication of scientific results, 124  
 reinstatement, 129-130  
 resignation, 114-115, 120  
 scientific freedom, 134  
 testimony, POD Hearings, 111  
 testimony, SSCSB Hearings, 72, 75, 94, 105, 106, 123-124, 126  
 biography, 171-173  
 Boulder-Washington relations, 319-322  
 dedication of IT&T Laboratory, 284  
 dedication of NBS Boulder Laboratories, 189  
 EEO activities, 471-472  
 ESSA, 492-493  
 establishment of JILA, 324-325, 327  
 establishment of the Samuel Wesley Stratton Award, 313-315  
 fire research, 505

Astin, Allen V. (*continued*)

flagpole, 488n  
Gaithersburg facilities, 475-478, 481, 482  
General Conference for Weights and Measures, **350**  
interview with, 62  
letter from R.H. Bahmer, 53n  
letter to G.M. Wheatley, 260  
letter to J.H. Hollomon, 483n  
letter to J.L. McClellan, 513n  
LINAC, 416  
meeting with Boulder Chamber of Commerce, 188  
memorandum from D.E. Parsons, 74n  
memorandum from I.C. Schoonover, 413  
memorandum from J.H. Hollomon  
Cryogenics Laboratory, 310  
NBS and Commercial Laboratories, 381  
memorandum from N.E. Golovin  
Bureau of Aeronautics Programs, 300-301  
NBS Requirements and Plans for a Nuclear Research Reactor, 413  
Working Fund Work Policy Statement, 301  
memorandum from N.L. Christeller, 302  
memorandum to D.R. Baldwin, 497, 503n  
memorandum to heads of executive departments, 432  
memorandum to J.F. Kincaid, 469n  
memorandum to J.H. Hollomon  
ADP Report to the President, 503n  
Engineering and Commodity Standards Activities, 380  
Engineering Standards, 381  
Issuance of Joint NIH-NBS Statement on Open Housing, 472  
on JILA, 328-329  
Program for Building Research, 309  
Proposed Augmentation of 1966 NBS RTS Budget Submission, 502  
memorandum to L.H. Hodges, 338  
memorandum to R.E. Giles, 496  
memorandum to W.F. Rapp, 508, 514  
memorandum to W. Williams, 305  
mission statement, 298, 307  
NRC-NBS postdoctoral research program, 191  
Planning-Programming-Budgeting System, 473  
proposal from R.M. White, 492  
Refinement of Values for the Yard and the Pound, 385n  
retirement, 470, 518-521, 598  
standards, responsibility for, 495-496

Astin, Allen V. (*continued*)

Study Paper on Major Needs of the National Bureau of Standards, 305-306  
United States National Committee, 440  
weights and measures for the states, 555, 558  
White House Panel on Civilian Technology, NIPS proposal, 340  
Astin, Catherine, 172  
Astin, John Allen, 172  
Astin, Margaret L. (formerly Mackenzie, Margaret L.), 172  
Astin Award, 316  
ASTM. *See* American Society for Testing and Materials (ASTM)  
astronomical time, 372-373, 374  
astrophysics research, 322-329, 403-404  
Atlas missile, 288, **289**  
atmospheric corrosion, 239-240  
atmospheric turbulence, theoretical studies, 276  
atomic and molecular physics research, 402-410  
Atomic and Radiation Physics Division, 66, 161, 213-218, 318  
atomic bomb, effect on science, 6  
atomic clocks, 11, 368-372  
ammonia molecule clock, **12**  
frequency standards, 272, 277  
time dissemination, 532  
Atomic Collision Cross Section Information Center, 554  
Atomic Energy Act of 1946, 13  
Atomic Energy Commission (AEC)  
clearance for E.U. Condon, 165  
Cryogenics Engineering Laboratory, **183**  
Division of Biology and Medicine, 588  
formation of, 6-7, 12-13, 157  
organic chemistry research, 223  
photonuclear research, 215  
radioactive fallout patterns, 267  
radioactive sugars, 223-224  
reactions of refractory materials, 251  
site investigations for, 476  
as sponsoring agency, 35, 66, 131, 192  
Super (bomb), 185  
Technical Analysis Division projects, 509  
atomic energy development, control of, **158**  
*Atomic Energy Levels*, 403  
Atomic Energy Levels Data Center, 554  
atomic nucleus study by electron scattering, 563-565  
Atomic Physics Division, 213-218, 402-410  
gyromagnetic ratio of the proton, 391-392  
organizational, 323n  
semiconductor research, 438, 560  
Atomic Physics Laboratory, 213  
Atomic Physics Section, 213, 323

atomic transition probabilities, 404, 435  
 atomic weights, 580-582  
 atomic weights, determining, 215  
 Auman, George E., 470, 471, 473  
 auroral region, 275  
 automatic data processing (ADP), 500-504  
 Automatic Data Processing Equipment Act. *See*  
   Federal Property and Administrative Services  
   Act of 1949, amendment  
 automatic scanning photoelectric spectrometer,  
   220  
 automatic field-intensity measurement equipment, —  
   275  
 automatic weather stations, 436  
 automobile clutches, 36  
 automobile engines, 205-206  
 automobile safety, 458, 494-500  
 automotive lead-acid batteries  
   battery mud, 86  
   charging efficiency, 86  
   cutaway view, 84  
   sulfation, 85  
   tests on, 86-87  
 automotive spark plugs, testing, 35  
 awards, performance, 313-317

## B

Babinet, Jacques, 37  
 background radiation, 464  
 Bahmer, Robert H., 50n, 53n  
 Bain, Robert F., 471n  
 balance, double-beam, 230  
 Baldwin, David R., 497, 503n  
 Bardeen, John, 11, 47, 148  
 Barger, Richard L., 527  
 barium-titanate powders, 251  
 Barnes, I. Lynus, 581n  
 Barnett, John D., 360, 361  
 Bartlett, Edward L., 383  
 Baruch, Bernard, 3  
 Basic Instrumentation Section, 192n  
 Bass, Arnold M., 318, 400, 401  
 BAT guided missile, 18  
 Battelle Memorial Institute, 579  
   battery additives research and testing, 80-84,  
     97, 113  
 Battery AD-X2  
   chemical composition, 96, 102, 103  
   guarantee, 80  
   instructions on package, 135  
   military tests, 93, 99  
   MIT test, 105, 110  
   NBS tests, 94-100, 105-107, 133

Battery AD-X2 (*continued*)  
   political cartoons, 118  
   results, 133-136  
   statistical design of tests, 265  
   suicide test, 265  
   test for House committee, 104  
   test for Senate committee, 105  
   tests for FTC, 102-104  
   tests for POD, 102-104  
   *See also* Protecto-Charge  
 battery mud, 86  
 battery research and testing, 80-84, 94  
 Bay, Zoltan, 528, 529  
 Bay of Pigs invasion, 287, 289  
 beam loading, 450  
 Beattie, James A., 109  
 Beckett, Charles W., 398  
 Beehler, Roger E., 371  
 Beene, James C., 127  
 beer meters, testing, 35  
 Beers, L. Yardley, 318  
 Bekkedahl, Norman P., 319n  
 Belanger, Brian, 534n  
 Bell, Karl E., 471n  
 Bell Telephone Laboratories, 146  
 Bender, Peter L., 314, 315, 391-392, 525n, 526  
 Bendigo, Bruce B., 130n  
 Bennett, John A., 240, 576n, 577  
 Bennett, Lawrence H., 429n  
 Bennett, Wallace F., 116  
 benzoic acid (7C-14) standard sample, 216  
 Bergstrom, John C., 565n  
 Berkner, Lloyd V., 439  
 Berky, Dean B., 187  
 Berlin Wall, 287  
 Bernstein, Barry, 390  
 Bertozzi, William, 565n  
 Best, Alfred S., 382  
 betatron, 56, 59  
 Bethe, Hans, 11  
 Better Business Bureaus, 83  
 Bickford, Nathan, 567  
 Big Bang theory, 11  
 Big Four conference in Geneva, 141  
 Biggs, Kathryn E., 471  
 Bikini Atoll, 158  
 BIPM. *See* International Bureau of Weights and  
   Measures (BIPM)  
 Birge, Raymond T., 278  
 Birmingham, Bascom W., 186, 470  
 bismuth-silver thermopile, 546  
 blackbodies, 387-388, 389, 545, 546  
 blackbody wavelength, 545, 546  
 Blaine, Lamdin R., 279, 280

- Bleany, Brebis, 208  
 Block, Herbert, 139  
 Block, Stanley, 358, 360-361  
 blood extender, 224  
 Blum, William, 218-219  
 Board of Standards and Appeals (BSA),  
   New York City, 76  
 Boggs, Kent D., **441**  
 bolometer, 545  
 bolometric voltage, 543  
 bolovac standard, 543  
 Bolton, Elmer K., 132  
 Bolton, Wilbur W., 478, 481  
 bombs, 5, 6, 147, 185, 186  
 bone-conduction hearing aids, 229  
 borate-alkali systems, studies, 249  
 Bottone, Paul W., 532  
 Boulder Chamber of Commerce, 183-184, 188  
 Boulder Laboratories  
   Boulder-Washington relations, 319-322  
   cryogenic facility, 185-187  
   dedication, 188, **189**  
   director, 319-320  
   land acquisition and appropriations, 184-185  
   site selection, 182-184  
 Bow, Clarence, 336  
 Bow, Frank T., 345-346  
 Bowen, Harold G., 42  
 Boyd, Alan S., 497  
 Boyd, W. Hunter A., **18**  
 Brady, Edward L., 330-331, 333, 514  
 Bragg, William Lawrence, 570  
 brake fluid standard, 495-496  
 braking systems, study, 500  
 Branscomb, Anne, 520  
 Branscomb, Lewis M.  
   article in *Physics Today*, 328  
   Atomic and Radiation Physics Division, 213  
   Atomic Physics Division, 318, 323n  
   Atomic Physics Section, 323  
   interviews, 324-325  
   Laboratory Planning Committee, 478n  
   photodetachment of electrons from negative  
     atomic and molecular ions, **404**  
   selection as director, 470, 518-522  
 Brattain, Walter, 11  
 Brenner, Abner, 219  
 Brickwedde, Ferdinand G., 185, 203, 206, 207,  
   209  
 bridge collapse study, 576-579  
 Bridges, Styles, 288  
 Bridgman, Percy W., 358  
 Briggs, John D., 50n  
 Briggs, Lyman J.  
   accounting of the Bureau's military work, 16n  
   Aquella, 74-79  
   Organic Act revision, 149, 151, 152  
   radiation programs, 59  
   report on Charters of Freedom, 49  
   S-1 Committee, 157  
   on storage batteries, 83-84  
   sundial, **485**  
   United States National Committee, 440  
 British Physical Society, 191  
 British standards, 555  
 Brizee, W., 95  
 broadcast stations. *See* radio stations  
 Brode, Wallace R.  
   as associate director, 176  
   as chairman of the NBS Editorial Committee,  
     116n  
   letter to C.J. Lapp, 190  
   memorandum from W.S. Hinman, 117, 119  
   as NBS acting director, 117, 119  
 Broida, Herbert P., 206, 399-401, 478n  
 Bronk, Detlev W., 119, 120, 304  
 Bronze Medal, award, 315-316  
 Brookhaven National Laboratory, 408, 569  
 Brooks, Jack, 500, 504  
 Brooks Act. *See* Federal Property and  
   Administrative Services Act of 1949,  
   amendment  
 Brown, Frederick W., 188, **189**, 319-320, 322  
 Brown, Linda, 142  
 Brown, Oliver, 142  
 Brown, Paul J., 497  
 Brownell, Herbert, Jr., **166**  
 Bruckner, Benjamin, **223**  
 Brunswick Laboratory, 582  
 bubble chamber, liquid hydrogen, 187, 447-448  
 Buck, Elizabeth Hawthorn, 48n  
 Buckley, Oliver, 145-146  
 Budenz, Louis, 3  
 Building and Housing Division, 253  
 building components, performance, 591  
 building research, Second Kelly Committee  
   Report, 309  
 Building Research Advisory Board, 308, 309, 336  
 Building Research Division  
   disaster investigation, 592-595  
   fire research, 595-598  
   Fire Research Section, 507  
   fire standards, 521  
   in Institute for Applied Technology, 344  
   performance concept, 590-592  
   programs, 449-452  
   standards programs, 521

building structures, thermal insulating capacity, 257

Building Technology Division, 253-261, 305, 380, 422, 449-452

Bullis, W. Murray, 586n

Bunting, Elmer N., 357-358

Bureau of Aeronautics (BuAer), U.S. Navy, 200, 300-301, 390, 426

Bureau of Animal Industry, 457

Bureau of Chemistry, Department of Agriculture, 218, 457

Bureau of Engraving and Printing, 218

Bureau of Naval Weapons, 390, 436

Bureau of Public Roads, 304n, 436, 577

Bureau of Supplies and Accounts, U.S. Navy, 267

Bureau of the Budget (BOB)

- ADP advisory council, 432
- Circular A-71, "Responsibilities for the Administration and Management of Automatic Data Processing Activities, 502-504
- Federal Information Processing Standards, 558, 559
- Planning-Programming-Budget System, 472
- See also* Office of Management and Budget (OMB)

Bureau of the Census, computer for census results, 41

Bureau of Yards and Docks, U.S. Navy, 258

Burgess, George K., 329, 368n, 389

Burnett, Harry C., 577

Burns, James MacGregor, 455

Burton, I., 95n

Bush, Vannevar

- heading the Office of Scientific Research and Development (OSRD), 7-8
- letter to G. Dunn, 150
- Organic Act revision, 150, 152
- report on basic research, 9
- Science, the Endless Frontier*, 8, 294
- scientific activities during the war, 145

Butrymowicz, Daniel B., 429n

Byers, Horace R., 304n

## C

Calibration and Measurement Services Committee, 378

calibrations

- bone-conduction hearing aids, 229
- of capacity standards, 226
- check standard, 535-536
- definition, 282n
- electrical instruments and equipment, 194
- calibrations (*continued*)
  - Electronic Calibration Center, 377-378
  - of force-measuring devices, 229, 362-367
  - gage blocks, 239, 346-349
  - high pressure, 355-362
  - laser wavelength, 522-524
  - length, 194
  - limited to basic standards, 283
  - of mass standards, 533-537
  - of measurement standards, 34-35, 37
  - of mechanical instruments, 226
  - National Measurement System, 31
  - photoelectric pyrometer, 205
  - using radio-frequency standards, 542-544
  - Radio Standards Division, 277, 395, 397-398
  - schedule of services and fees, 379
  - sound and vibrations, 228
  - standard samples for, 31-32, 379-380
  - standardizing laboratories, 284-285
  - temperature, 353-355
  - transducers, pressure and displacement, 436
  - of viscometers, 204
  - See also* measurements; standards

Califano, Joseph A., Jr., 506n

Calvert, Wynne, 444

Cambridge Laboratories, United States Air Force, 586

Cameron, Joseph R., 534

Campbell, William R., 243n

Canadian spy trials, 3

candle, standard, 546

Cannon, Edward W., 262

Cantazaro, Edward, 581n

Capacity, Density, and Fluid Meters Section, 318

Cape Canaveral, Mercury Control Center, 445

Capper, Arthur, 163

carbohydrate chemistry, 222

carbon-14 standard samples, 380

carbon dating, 11, 380

carbon-filament incandescent lamps, 546

carbonates, study of, 251

Carnegie Endowment for International Peace, 5

Carr, Francis, 140

Carrion, Walter, 525n

Carson, Rachel, 293, 462

Carter, Gesina C., 429n

Carter, Robert S., 414, 567

Casella, Russell C., 212-213

Caskey, Charles T., 464

Caswell, Randall S., 414

Catholic University, 565

cat's whisker/silicon-rectifier harmonic crystal mixer, 528

Cavendish Laboratory, Cambridge University, 297

- Cederberg, Elford A., 483  
 Celsius scale, 44–45  
 cement-aggregate bond in concrete, 449  
 cement research and testing, 246, 247, 283, 380  
 Centennial Exposition (Philadelphia), 48  
 Center for Computer Sciences and Technology (CCST), 503, 558–559  
 Center for Radiation Research, 503, 568  
 Center for Vehicle Safety Standards, 497  
 Central Radio Propagation Laboratory (CRPL)  
   Boulder Laboratories, 182–188, **189**  
   broadcast stations, 272  
   divestiture, 466, 493  
   divisions, 318, 438  
   field stations, 272, **274**  
   formation of, 269–272  
   International Geophysical Year, 272, 275, 439–443  
   Interservice Radio Propagation Laboratory  
     conversion, 270–271, 301  
     location criteria, 182–183  
     mission, 305, 307  
     organizational changes, 318, 319, 468  
     radio weather prediction service, 67  
     reorganization, 1964, 342, 343  
     Second Kelly Committee Report, 438  
     space activities, 443–445  
     speed of light, 214, 279, 280–281  
     *See also* Interservice Radio Propagation Laboratory  
 ceramics, 201–203, 247, 248, 252, 573–575  
 Certified Reference Materials, 582  
 cesium beam clocks, 369–372  
 Chaconas, Grace, **348**  
 Chambers, Whittaker, 5  
 Chang, R.F., 525n  
 Chapman, Sydney, 439  
 characterization of crystals, 582–586  
 Charles, Richard J., 573  
 Charpie, Robert A., 515n  
 Charpy V-notch impact tests, 243  
 Charters of Freedom, preserving, 47–53, 234  
 check standard, 535–536  
 Chelton, Dudley B., 186  
 Chemical Kinetics Data Center, 554  
 Chemical Metallurgy Section, 238, 428  
 chemical thermodynamic properties of substances, 222, 554  
 Chemistry Division, 218–225, 318, 419–421  
 Chemistry of Mineral Products Section, 246  
 Cheyenne Mountain, tropospheric propagation, 188  
 Child Nutrition Act of 1966, 456  
 Child Protection Act of 1966, 458  
 Child Protection and Toy Safety Act of 1966, 459  
 choking (vapor lock), 446  
 cholesterol, Standard Reference Material, 551–552  
 Christeller, Norman L., 302  
 Christian, John F., 595  
 Christian, Robert, **498**  
 chromatograms, **235**  
 chromatographic separation, 219  
 chromatography, 234, **235**  
 chromium, pure samples, 239  
 Churchill, Winston, 3  
 CIPM. *See* International Committee for Weights and Measures (CIPM)  
 Circular 374, *X-Ray and Radium Protection*, 59  
 Circular 470, *Precision Resistors and Their Measurement*, 32  
 Circular 476, *Measurement of Radioactivity*, 32  
 Circular 490, *The Geiger-Mueller Counter*, 32  
 Circular 499, *Nuclear Data*, 214  
 Circular 500, *Selected Values of Chemical Thermodynamic Properties*, 222, 421  
 Circular 504, *Battery Additives*, 97, 99–100  
 Circular 550, *Mechanical Failures of Metals in Service*, 240  
 Circular 566, *Bibliography of Solid Absorbents, 1943 to 1953*, 222  
 Circular 571, *Electron Physics Tables*, 218  
 Circular 583, *X-ray Attenuation Coefficients from 10 Kev to 100 Mev*, 214–215  
 civil disobedience, 287  
 Civil Rights Act of 1964, 456, 470  
 civil-rights movement, 142, 287  
 Civil Service Commission, 150, 188, 306n  
 Civilian Industrial Technology (CIT), 333–337, 518n  
 Clapp, Verner, 47  
 Clark, Joseph E., 507  
 Clark electrolytic cells, 22  
 Classification Act of 1949, 150, 151  
 Clausius-Clapeyron equation, 45n  
 Clay, Lucius D., 146  
 Clean Air Act, 293  
 Clearinghouse for Federal Scientific and Technical Information, 513–515  
 Clewlow, Carl, 502  
 Clinical Laboratories Improvement Act of 1967, 458  
 clinical standards, 551  
 clock synchronization, 532–533  
 CN gas laser, 528  
 Coast and Geodetic Survey, 281, 304n, 508  
 Coast Guard, 243, 259, 509  
 coatings for nuclear reactors, 248  
 cobalt-based alloys, analysis for jet-engine turbine blades, 219



- cobalt gamma-ray standards, 32  
 Coblenz, William W., 410, 546, 547  
 Cochran, A.L., 311  
 Cochran, William G., 132n  
 coded character set, 559  
 Codes and Specifications Section, 254  
 Codling, Keith, 405-407  
 Cohen, E. Richard, 279, 281  
 Cohen, Marvin L., 560, 561, 563  
 Cohn, Roy, 140  
 coin-weighing machine, 195  
 cold-neutron source, 568  
 Cold War, 3, 4, 6  
 Cole, W. Sterling, 158  
 collagen, structure of, 234, 235  
 College of American Pathologists (CAP), 551  
 Collett, Charles T., 318  
 Collins, Michael, 460  
 colloid chemistry, 218, 224  
 color measurements, 194  
 color television, 147, 148  
 Colorado National Guard Radar Armory, 188  
 Colson, James P., 425  
 Columbia Broadcasting System, 148  
 Colwell, Jack H., 561  
 combinatorial analysis, 431-432  
 Combustion and Controls Section, 226n, 228  
 combustion chamber, 228  
 Comet aircraft, 6, 147  
 Commerce Science Fellowship Program, 505  
 Commission on Atomic Weights and Isotopic Abundances, 582  
 Committee F-1 on Materials for Electron Devices and Microelectronics, ASTM, 586  
 Committee for Medical Research, 7  
 Committee for the Definition of the Meter, 349  
 Commodity Credit Corporation (CCC), 303  
 commodity standards, 381-382, 521  
 commodity testing. *See* product testing  
 communications satellites, 295  
 communism  
   containment, 4, 6  
   international, 3, 4, 141  
   policy of President Eisenhower, 141, 166  
 compact oscilloscope, 195  
 complex dielectrics, 219  
 Compton, Karl T., 163  
 Computation Laboratory, 261, 264, 432, 503  
 computation work, 261-269  
 computer explosion, 11, 40-44  
 Computer Science and Technology Center, 503  
 Computer Service Center, 432  
 Computer Sharing Exchange, 432
- computers  
 AMOS IV, 433, 434  
 and applied mathematics, 40-44, 261-269, 431  
 component development, 433  
 DYSEAC, 267, 268  
 EDSAC, 43  
 ENIAC, 11, 41  
 IBM, 146  
 PILOT, 433  
 programs, 433-435  
 RCA 501, 295  
 SEAC, 42-44, 263, 265, 266, 267  
 STATAC-SCOOP, 267  
 SWAC, 43, 263, 266, 267, 269  
 UNIVAC, 41-42, 146  
 concrete research and testing, 246, 247, 254-255, 449-450  
 Concreting Materials Section, 246, 422  
 Condon, Edward Uhler  
   appearance before budget committee, 269-270  
   applied mathematics program, 41  
   Aquella, letter to *Forbes* and *Reader's Digest*, 78  
   Atomic and Radiation Physics Division, 161, 213  
   Battery AD-X2  
     correspondence with K.B. Willson, 93, 98  
     correspondence with M. Randall, 90, 92, 94  
     correspondence with W.F. Knowland, 91-92  
     letter to H.H. Lehman, 101  
     memorandum from G.W. Vinal, 93  
     statement to NBBB, 93  
   biography, 154-159  
   Bureau's peacetime functions, 66  
   Circular 474, *Automotive Antifreezes*, 74  
   creativity, 63  
   as director of NBS, 66n, 156  
   on instrumentation, 192  
   letter from C.E. LeMay, 7  
   letter to J.D. Briggs, 50n  
   *Los Alamos Primer*, 157  
   low-temperature physics research, 206  
   memorandum to H.S. Truman, 167  
   radiation programs, 59  
   radio propagation and radio standards  
     research criteria, 182-183  
   resignation, 102, 168  
   security issues, 13, 159-170

- Condon, Edward Uhler (*continued*)  
     staff support, 166–167  
     stripped of security clearances, 14  
 Condon, Emilie (formerly Honzik, Emilie), 156,  
     160, 162, 163, 165–166  
 Condon Award, 316  
 Conference on creative engineering education, 516  
 Conference on Phenomena in the Neighborhood  
     of Critical Points, 572  
 Connor, John T., 470, 489  
 Connor, William S., 279, 280c  
 constant-temperature oven, **278**  
 Constitution and Microstructure Section, 246  
 constitution diagrams, 239  
 Constitution of the United States, preservation of,  
     47–53, 234  
 construction materials, fire tests, 595–596  
 Consultative Committee on Thermometry (CCT),  
     541  
 Consumer Advisory Council, 457  
 Consumer Credit Protection Act, 459  
 Consumer Product Safety Act of 1972, 493  
 Consumer Product Safety Commission, 493  
 consumer protection legislation, 456–459, 493  
 continuous-wave lasers, 522  
 convertible funds, 300–302  
 Cook, Herbert D., **523**  
 Cooke, Earl, **499**  
 Coolidge tube, 57  
 Cooper, John W., 407n, 409n  
 Cooper, Leon N., 148  
 Coplon, Judith, 165  
 copper plate, Declaration of Independence, 48  
 copper salts, effects on fur skins, 236  
 copper studies, 238  
 cordless microphone, 195  
 corn syrup, analysis of, 219  
 corner-cube retroreflectors, 525–526  
 Corona Laboratories, 67, 182  
 corrosion research, 28–29, 239–240, **241**, 428  
 Corrosion Section, 238, 239–240, **241**, 428  
 cosmic noise studies, 273–275  
 cosmic radiation, 56  
 cost benefit analysis, 509  
 Cottingham, Robert L., 130n  
 cotton, structure of, 234  
 Council of Economic Advisors, 457  
 Cousteau, Jacques, 293  
 CPT theorem, 212, 296  
 crack growth behavior, 573–575  
 Craig, D. Norman, 55, 110n, 130n, 581n  
 Crannell, Hall L., 565n  
 creative engineering education, 516  
 creep studies, 233, 238  
 Creitz, E. Carroll, 49n, 51n, **52**  
 Crick, Francis H.C., 11, 296  
 Critchfield, Charles L., 200  
 critical opalescence, 571  
 critical phenomena, 569–572  
 Crittenden Award, 316  
 Cronkite, Walter, 455  
 Cryogenic Engineering Data Center, 449  
 Cryogenic Engineering Division, 305  
     organizational, 181, 186, 187, 305, 319  
     research, 445–449  
 Cryogenic Engineering Laboratory, **183**, 195  
     AEC work, 185–187  
     mission, 308–309, 310  
     organizational, 318, 343  
 Cryogenic Engineering Section, 186  
     cryogenic equipment, 447–449  
     cryogenic liquids production, 449  
 Cryogenic Physics Section, 541  
     cryogenic physics research, 207–207, 446–447  
 Cryogenics Division, 522, 541, 584  
 Crystal Data Center, 554  
     crystal growth and characterization, 582–586  
     crystal structure determination, 252, 358, 360,  
         568–569  
     crystal time-of-flight instrument, 568  
     crystalline inorganic compounds, thermal  
         decomposition, 251  
     crystallization, 220, 425  
 Crystallization of Metals Section, 428  
 Cuban missile crisis, 289–290  
 Cullen, William C., 261n  
 currency counter, 35  
 Currie, D.G., 525n  
 Curtis, Alexander J., 393n  
 Curtis, Roger W., 199  
 Curtiss, John H., 41, 42, 261, 262, 265  
 Curtiss, Leon F., 32  
 Cushen, W. Edward, 508  
 Customs Service, determining import duties, 34,  
     224  
 Cutkosky, Robert D., 199–200

## D

- Daddario, Emilio Q., 464  
 Daisy Decelerator, **499**  
 Dalmas, Victor P., 104n  
 Danby, Gordon, 296  
 dark-hemisphere effect from solar flares, 276  
 data centers, NSRDS, 553  
 data networks, National Measurement System, 511  
 Data Processing Systems Division, 261, 263, 267,  
     305, 433–436

data standards, Center for Computer Sciences and Technology, 559  
 Davis, D.D., 533n  
 Davis, John W., 595  
 Davis, Raymond, 113n  
 Davis, Raymond, Jr., 464  
 Day, G.W., 548n  
 dead-weight loaded-piston gage, 356  
 dead-weight machines, 363-367  
 Debye, Peter J., 572  
 Declaration of Independence, preservation of, 47-53, 234  
 Defense Atomic support Agency, 412  
 Deficiency Appropriation Act, 1950, 180n  
 degradation of polymers, 233, 426  
 degradation research, 426  
 Dellinger, J. Howard, 272  
 Democratic National Committee, 520  
 density-driven flow, 228  
 Dental Research Section, 232, 236-237, 319n  
 Department of Agriculture, 218, 258  
 Department of Commerce (DOC)  
   Commerce Science Fellowship Program, 505  
   EEO program, 317, 470  
   NBS reorganization, 1964, 338-345  
   Office of Science and Technology, 381  
   Panel on Invention and Innovation, 515, 516  
   performance awards, 313  
   post of assistant secretary for science and technology, 294  
   security clearances, 166  
   transportation study, Northeast Corridor, 508  
 Department of Defense (DOD)  
   Advanced Research Projects Agency (ARPA), 398  
   materials studies for, 258  
   polymer degradation studies, 426-427  
   support of fundamental research, 309-310  
   technical support for, 131  
   weapons development for, 193  
 Department of Energy, 517, 582  
 Department of Housing and Urban Development (HUD), 509, 591, 592, 595-596  
 Department of Science, proposal for, 339  
 Department of Scientific and Industrial Research (U.K.), 273  
 Department of the Interior, 509  
 Department of the Treasury, 195  
 Department of Transportation (DOT), 29, 497, 508, 577  
 Department of Transportation Act, 458  
 De Simone, Daniel V., 515  
 detector-based radiometry, 545, 548  
 detente, 141  
 detergents in solution, 224  
 dextran, 224  
 Diamond, Harry, 172  
 diamond-anvil cell, 229, 357-362, 423  
 Diamond Ordnance Fuze Laboratory, 66-67, 301, 302. *See also* Harry Diamond Ordnance Laboratory  
 Dibeler, Vernon H., 318, 421n, 581n  
 Dicke, R.H., 525n, 526n  
 dielectric properties of polymers, 200, 392-394  
 Dielectric Section, 200, 392  
 dielectric work, 219, 250  
 Dietzen, Robert, 185  
 differential equations, 263, 264  
 diffusion by vacancies, 429  
 Diffusion Data Center, 429  
 Diffusion in Metals Data Center, 554  
 dilution refrigerator, 541  
 disaster investigation, 592-595  
 Distant Early Warning (DEW) arctic radar network, 254  
 Distillation Products Industries, 552  
 distribution-free methods, 265  
 Division of Biology and Medicine, Atomic Energy Commission, 588  
 Division of Building and Housing, Department of Commerce, 253  
 divisional laboratories, 34  
 DNA molecular structure, 11, 296  
 Doctorow, E.L., 28n  
 document retrieval system for physico-chemical data, 421  
 Domen, Steve R., 411n  
 Domsitz, Myron G., 586n  
 Donnelly, Paul C., 130n  
 donut in synchrotron, 61  
 Doppler shift, 375, 527  
 Dorsey, N. Ernest, 57-58, 197, 198, 279, 534  
 dosimetry research, 411, 418  
 double-beam balance, 230  
 Douglas, Paul, 458  
 draft lottery, 565-567  
 drifting process, 589  
 Driscoll, Raymond L., 198-200, 314, 316, 391-392  
 Drullinger, Robert E., 281n  
 dry bomb, 186  
 dry-powder fire extinguishers, 260  
 Dryden, Hugh, 18  
 DuBridge, Lee A., 10n, 131n, 146, 461, 463  
 Dulles, John Foster, 141  
 DuMond, Jessie W.M., 278-279, 281  
 Dunn, Gano, 149, 150  
 Dunstan, Lura P., 581n

dynamic periphery, 27  
dynamometers, 229, **231**  
DYSEAC computer, 267, **268**

## E

- E layer, radio propagation, 443  
Early Bird satellite, 465  
Earth-Moon trajectory, 44  
earthquakes, 508, 594  
Earth's oblateness, calculating effects of, 430, **431**  
Eastern Europe, Yalta agreement, 3  
Eastman Kodak Corporation, 52  
Eberhard, John P., 468  
Eby, Ronald K., 425  
*Echo* satellite, 295  
Eckert, J. Presper, 11, 41  
economic issues, 291–293, 459, 460–465  
ECR-10 (Electrically Compensated Receiver), 549  
Edminster, T.W., 311  
EDSAC computer, 43  
Edward Bennett Rosa Award, 315  
Edward Uhler Condon Award, 316  
EEO. *See* Equal Employment Opportunity  
Eigenvalue problems, 263  
Eight-fold way, 296, 412  
Einstein, Albert, 163  
Eisenhart, Churchill  
    Battery AD-X2  
        FTC hearings, 130n  
        POD hearings, 110n  
        suicide test, 265  
    as chief of the Statistical Engineering  
        Laboratory, 265, **266**  
    on E.U. Condon, 155  
    interviews, 168n, 340  
    NIPS proposal, 340  
    recognition, 313  
    reliability of measurements, 534  
Eisenhower, Dwight D.  
    A.V. Astin's resignation, 114  
    dedication of NBS Boulder Laboratories,  
        188, **189**  
    integration, 291  
    Khrushchev's visit, 289  
    policy toward communism, 141, **166**  
    reaction to sputniks, 288  
    refusal to sign the Geneva accords, 291  
    science advisors, 146, 294  
    speech at Dartmouth University, 140  
Eisenhower-Nixon ticket, 112  
elastomers, 232, 233, 234  
Elder, Frank R., 405n  
electrical apparatus, testing, 35  
electrically calibrated radiometer, 548–549  
electrical resistance, 390  
electrical standards, 20–21, 22, 196–200, 537–540  
electrical units, international, 537–538  
Electricity and Electronics Division, 181, 239,  
    261, 317, 436  
Electricity and Optics Division, 38  
Electricity Division, 181, 193–200, 317, 390–394,  
    436  
Electrochemical Properties of Interfaces,  
    Agricultural University of Wageningen, The  
    Netherlands, 554  
electrochemistry, 28  
Electrochemistry Section, 81–82, 87  
electrodeposition, 218–219, 224, **225**, 585  
Electrodeposition Section, 318, 419  
electrodynamometer, **199**  
electrolytic theory, 87  
Electromagnetics Division, 548  
electron-beam interferometer, 216, **217**  
Electron devices Section, 192n  
electron emissions, measurement of angular  
    asymmetry, 208  
electron optics, 409  
Electron Physics Section, 216, 407, 408–410  
electron scattering, 408–409, 563–565  
electron synchrotron, 405–408  
electron tubes, testing, 35  
Electronic Calibration Center, 277, 377–378  
Electronic Computers Section, 261, 263, 266–267  
electronic devices and instruments, 195  
Electronic Instrumentation Division, 586n  
Electronic Instrumentation Section, 192n  
Electronic Research Center, NASA, 586  
electronic revolution, 146  
electronic scanning microscope, 436  
Electronic Technology Division, 586n, 588  
Electronics and Ordnance Division, 172. *See also*  
    Harry Diamond Ordnance Laboratory  
Electronics Division  
    computers, 42, 263, 266–267  
    equipment, 195  
    organizational, 181, 261  
electrophoresis, detergents in solution, 224  
electroweak theory, 464  
Elementary and Secondary Education Act of 1965,  
    456  
Eli Whitney Laboratory, 285  
Ellenberger, William I., 475  
Ellett, Alexander, 65  
Ellinger, George A., 242n, 244n  
ellipsometry, 426, **427**  
Elmendorf Air Force Base (Anchorage, Alaska), **16**

Elwell, L.B., 528n  
 Enameled Metals Section, 246  
 enameled steel panels, 249  
 Energy-Related Inventions Program, 517  
 Engine Fuels Section, 318  
 Engineering and Related Standards Committee, 378  
 Engineering Electronics Section, 192n  
 Engineering Mechanics Laboratory, 482, 483  
 Engineering Mechanics Section, 226n  
 Engineering Metallurgy Section, 428  
 ENIAC (Electronic Numerical Integrator and Computer), 11, 41  
 Eniwetok, 267  
 environmental issues, 28, 142-143, 293, 456  
 Environmental Science Services Administration (ESSA), 271, 322, 466, 492-493  
 ephemeris second, 373  
 epochal time, 367n, 372  
 Epsom salts, 82  
 Epstein, Edward S., 492  
 Equal Employment Opportunity (EEO), 317, 470-472  
 Equal Employment Opportunity Award, 316  
 Equal Pay Act of 1963, 317  
 Equation of State Section, 571  
 equilibrium diagrams, 253  
 equipment for cryogenics programs, 447-449  
 error voltage in servo-feedback systems, 195  
 Essen, L., 373n  
 Eugene Casson Crittenden Award, 316  
 eugenol, 237  
 Evans, William H., 421n, 554  
 Evenson, Kenneth M., 281n, 528-529  
 Everitt, William L., 131n  
 Evers, Medgar, 287, 292  
 Executive Order 8587 (first public statement of U.S. Government nondiscrimination policy), 317  
 Executive Order 9835 (loyalty investigations of Federal civilian employees), 13  
 Executive Order 10590 (equal opportunity for all qualified persons), 317  
 Executive Order 10807 (formed the Federal Council for Science and Technology), 294  
 Executive Order 11717 (Government-wide data processing standards transferred to secretary of commerce), 560  
 experimental data, analysis, 265  
 experimental design, 265  
*Explorer 1* satellite, 288, 439  
 explosions, studies of, 264  
 extended ASCII character set, 560  
 extraterrestrial noise studies, 273-275  
 extreme value theory, 265

## F

fabrics, flammability, 260  
 Fabry-Perot interferometer, 396, 529  
 face centered cubic (FCC) metals, 430  
 Fahrenheit scale, 44  
 failure analysis activity, 576-579  
 Fair Packaging and Labeling Act, 459, 466, 493  
 Faller, James E., 525n, 526  
 Fano, Ugo, 61, 62, 312, 409  
 Fano factor, 589  
 Faraday constant, 54-55, 391  
 fatigue studies, 238  
 Faubus, Orville, 291  
 Faust, Charles L., 2  
 FCC (face centered cubic) metals, 430  
 Federal Aviation Agency (FAA), 436, 598  
 Federal Bureau of Investigation (FBI), 161, 162, 164, 165, 569  
 Federal Council for Science and Technology (FCST)  
   Clearinghouse for Federal Scientific and Technical Information, 513  
   fire research, 309, 504-505  
   formation of, 146, 294  
   Joint Institute for Laboratory Astrophysics, 324  
   National Hydraulics Laboratory, 311  
   National Standard Reference Data System, 330, 553-554  
 Federal Food, Drug, and Cosmetic Act, 457  
 Federal Highway Administration, 577  
 Federal Information Processing Standards (FIPS), 522, 558-560  
 Federal Information Processing Standards Publications (FIPS PUBS), 559.  
 Federal Nonnuclear Energy Research and Development Act of 1974, 517  
 Federal Policy on National Standard Reference Data System, 330  
 Federal Property and Administrative Services Act of 1949, amendment, 466, 500, 504, 558  
 Federal Trade Commission (FTC)  
   AD-X2 hearings, 128, 130  
   AD-X2 testing, 83, 95, 103  
   Aquila, 76, 77  
   complaints against Pioneers, 94-95, 128-129  
   concerned with false advertising claims, 282  
   formation of, 457  
   letter from V.L. Smithers, 95  
   NBS reports to 95, 96  
   NBS testing for, 71  
 Federation of American Scientists, 116n

- Feinstein, Hymin J., 110n  
 Ference, Michael, Jr., 304n  
 Ferguson, Homer, 125  
 Ferguson, Robert E., 318, 421n, 473  
 Fermi, Enrico, 61  
 Fermi National Accelerator Laboratory, 464  
 ferromagnetic alloys, study of, 392  
 Feynman, Richard, 11  
 fibrous materials, spontaneous ignition of, 259-260  
 field-intensity measurement equipment, automatic, 275  
 field stations, 14-15, 16, 246, 272, 274  
 field-strength recording stations, 275  
 Fieser, Louis F., 552  
 Film Optical Scanning Device for Input to Computers (FOSDIC), 195, 436-437  
 fine-structure constant, 396  
 FIPS PUBS. *See* Federal Information Processing Standards Publications  
 fire extinguishers, 259, 260  
 Fire Protection Section, 254  
 fire research, 259-260, 309-310, 451-452, 504-507, 595-598  
 Fire Research and Safety Act of 1968, 458, 466, 506-507  
 Fire Research Section, 507  
 fire safety program, 505-506  
 Fire Technology Division, 507  
 Fivozinsky, Sherman P., 564, 565  
 flagpole, 488n  
 flame photometry, 219  
 flame spread, 259  
 flammable fabrics, 260  
 Flammable Fabrics Act, 260, 457, 459, 466, 493-494, 506  
 Flanigan, John, 520-521  
 Flanigan, Peter, 520-521  
 Fletcher, Donald G., 471  
 Flood, Daniel J., 300  
 flood investigation, Fairbanks, Alaska, 593  
 floor materials, study of, 258  
 Floor, Roof, and Wall Coverings Section, 254  
 Florman, Edwin R., 279, 280-281  
 flow in liquids, 228  
 fluid flow processes in cryogenics, 446  
 Fluid Mechanics Section, 226n  
 foamed concrete, 255  
 Foley, Thomas, 458  
 Food and Drug Administration (FDA), 457, 569  
 Food Stamp Act of 1964, 456  
 force-measuring devices for calibrations, 229, 362-367  
 force standards, 229  
 Forman, Richard A., 360  
 Fort Collins, CO, 376-377, 529-530  
 FORTRAN, 146  
 forward scatter propagation, 273  
 FOSDIC (Film Optical Scanning Device for Input to Computers), 195, 436-437  
 FOSDIC IV storage device, 437  
 Fowler, Howland A., 540  
 fractional melting, 220, 221  
 fracture mechanics, 573-575  
 Franken, P.A., 526n  
 Franklin, Alan D., 319, 478n  
 Franklin, Philip J., 381  
 Frederikse, Hans P. R., 561  
 free-air ionization chamber, 58  
 freedom riders, 292  
 free-floating weather buoy, 195  
 Free Radicals Program, 206, 399-402  
 Free Radicals Research Section, 206, 318, 400  
 freezing-point temperature standard, 551  
 frequency  
   of light, 527-529  
   low frequency propagation, 276  
   proton precession, 55n, 391  
   radio dissemination of, 374-377  
   standards, 277, 368-372, 542-544  
   time dissemination, 374  
   UHF range, 272-273  
   VHF range, 272-273, 443  
 Frequency Utilization Research Section, 272  
 Fridinger, Tomas, 584  
 Friendly, Alfred, 162n  
 Fröhlich theory, 46-47  
 Frye, Paul M., 304n  
 fuel metering, 390  
 Fugassi, J. Paul, 132n  
 Fuller, Everett G., 554  
 fundamental constants  
   Faraday constant, 54-55, 391  
   fine-structure constant, 396  
   Josephson constant, 538-539  
   proton gyromagnetic ratio, 391-392  
   Rydberg constant, 403  
   speed of light, 278-281, 396  
   standards and, 54-55  
   Stefan-Boltzmann constant, 546

## G

- Gagarin, Yuri, 288  
 gage blocks, 239, 346-349, 536  
 Gaither Report, 146

- Gaithersburg facilities  
 construction and relocation, 487-489  
 cost estimates, budget requests and appropriations, 475-476, 477-478, 481-483, 489  
 dedication, 489  
 facilities after WWII, 474-475  
 facilities requirements and design, 480-481, 483-484, 487, 488n  
 flagpole, 488n  
 Gaithersburg Planning Group, 478, 488  
 gates, 485  
 Kelly Committee Report on physical plant, 475  
 Laboratory Planning Committee, 478, 480, 487n  
 land acquisition, 479  
 Newton apple tree, 474, 490  
 policy of dispersal, 475  
 site description, 490-491  
 site selection, 476-477  
 staff relocation, 488-489  
 sundial, 485  
 test wall, 491
- Gaithersburg Planning Group, 478, 488
- Galbraith, John Kenneth, 291, 333
- Galler, Gerald M., 433
- gallium alloys for dental fillings, 237
- Gammon, Howard, 502
- Gamow, George, 11
- Gardner, Irvine C., 193, 301n, 318
- Garner, C.C., 102, 103n
- Garner, Ernest L., 581n
- Garvin, David, 554
- Garwin, Richard L., 212
- gas analysis programs, 220
- gas phase reaction kinetics, 554
- gates, 485
- Gatterer, Lawrence E., 532
- Gear Metrology Laboratory, 387, 388
- Geist, Jon, 548-549
- Gelfin, Samuel, 163
- Gell-Mann, Murray, 296, 412
- General Conference for Weights and Measures (CGPM), 350, 352, 365, 372, 373, 386
- General Electric Company, 56
- General Motors, 458
- General Services Administration (GSA), 257, 380, 476, 559
- Geological Survey, 569
- George A. Uriano Award, 316-317
- geosynchronous satellite, 532
- germanium diodes, 43
- germanium radiation detectors, 588-589
- GI bill of rights, 2
- Gifford, William E., 185
- Giles, Robert E., 323, 327, 496
- Gilles, Louis, 51
- Gilliam, Otis R., 280
- Gilman, John J., 573
- Glashow, Sheldon, 464
- glass  
 entrophy of, 250  
 fracture mechanics, 573-575  
 optical, 248  
 research, 248-250  
 SRMs, 550-551  
 transition, 233
- Glass Section, 246
- Glauber's salts, 82
- Glennon, Barbara M., 404n
- Godfrey, Arthur, 148
- golden age of science, 294-297
- Golden, William T., 145
- Goldman, Eric F., *The Crucial Decade—and After: America, 1945-1960*  
 on Eastern Europe, 3  
 on McCarthyism, 140  
 on national turbulence, 5  
 post-World War II economic issues, 2  
 on Sinclair Weeks, 112  
 on Soviet challenge, 143
- Gold Medal, award, 313
- Golovin, Nicholas E.  
 associate director, 176  
 Bureau of Aeronautics programs study, 300-301  
 Gaithersburg facilities, 478, 480, 481  
 Institute for Applied Science proposal, 301-302  
 nuclear reactor program, 413  
 Working Fund Work Policy Statement, 301n
- Goodman, Walter, 170
- Goodwin, Norman, 104
- Gordon, James P., 147, 296
- Gordon, Kermit, 501n
- Gordon Report, 501-502
- Gordy, Walter, 280
- Graham, Hylton, 478
- Gramlich, John W., 581n
- Grand Unified Theories, 54n
- graphite for nuclear reactors, measurement, 251
- Great Society, 287, 456, 457-458
- Green, Melville S., 318, 569-572
- Griffith criterion for fracture, 573
- Gross, Daniel, 261n, 597
- gross national product (GNP), 142, 143-144
- Groves, Leslie R., 169

GR-S (Government Rubber-Styrene), 233, 234  
Gruening, Ernest, 383  
guarded-field ionization chamber, 58  
guided-missile research laboratory, 67, 182  
guided missiles, 18, 182  
gyromagnetic ratios, 55n, 391-392, 397

## H

Haddon, William, Jr., 497  
Hagan, Lucy B., 403n  
Hagenauer, Rene, 74-76, 79  
Haggerty, Patrick E., 468  
Hall, John L., 328, 527  
Hall, R.G., 373n  
Hall, William G., 218n  
halogen compounds, 82  
Hamer, Walter J.  
    Battery AD-X2  
        correspondence with J.M. Ritchie, 100  
        FTC hearings, 130n  
        POD hearings, 110n  
        report, 102n  
    chief of the Electrochemistry Section, 81, 82  
    determination of the Faraday constant, 55n  
Hamilton, C.A., 548n  
Hammel, E.F., 185n  
Handbook 50, *X-ray Protection Design*, 215  
Handbook 52, *Maximum Permissible Amounts of Radioisotopes in the Human Body and Maximum Permissible Concentrations in Air and Water*, 215  
Handbook 53, *Recommendations for the Disposal of Carbon-14 Wastes*, 215  
Handbook 55, *Protection Against Betatron-Synchrotron Radiations Up to 100 Million Electron Volts*, 215  
Handbook 56, *Safe Handling of Cadavers Containing Radioactive Isotopes*, 215  
Handbook 77, *Precision Measurement and Calibration*, 379  
Handicapped Children's Early Education Assistance Act, 456  
Harding, Warren G., 49  
hard superconductor, 563  
hardware standards, Center for Computer Sciences and Technology, 559  
Harriman, Averell, 161-162, 164-165  
Harris, Forrest K., 540  
Harris, Jack A., 90, 95  
Harry Diamond Ordnance Laboratory, 66-67, 131, 132n. *See also* Diamond Ordnance Fuze Laboratory  
Hart, Philip, 458  
Harvard University, 569  
Hayden, Carl T., 477  
Hayward, Raymond W., 147, 209-212  
hearing measurements, 229  
Heat and Power Division, 181, 203-207  
heat content of radiation, 544n  
Heat Division, 181  
    critical phenomena, 569-572  
    Free Radicals Program, 399-402  
    International Practical Temperature Scale, 541  
    organizational changes, 181, 318, 390  
    responsibilities, 398-399, 560  
heated-thermocouple anemometer, 257  
Heating and Air Conditioning Section, 254  
heat transfer studies, 256, 446-447  
Hefner (amyl acetate) lamp, 546  
helium liquefier, 206  
helium-neon laser, 351, 522, 524, 527  
helium research, 45  
helium, study of absorption spectrum, 407  
Heller, Walter, 333  
Henry, Robert L., 201  
Herman, Robert, 11  
Herring, Frank W., 304n  
Herschel, Friedrich W., 544  
Herzfeld, Charles M., 318, 402n  
hexagonal (HCP) crystal, 430  
Heydemann, Peter L.M., 357  
High Altitude Observatory, Hawaii, 403  
High Energy Radiation Section, 416  
high-energy x rays, 214-215  
high-field cryogenic magnet, 448  
high-frequency field-strength meter, 395  
High Frequency Standards Section, 272  
high-pressure research, 355-362  
high-temperature drop calorimeter, 250  
Higher Education Act of 1965, 456  
Highway Safety Act of 1966, 458  
Hill, David, 120  
Hillig, William B., 573  
Hilsenrath, Joseph, 188-191, 318, 433-434, 571  
Hinman, William S., Jr., 117, 119  
Hipple, John A., 55, 392n  
Hiss, Alger, 5  
Hobbs, Robert B., 319  
Hocker, L.O., 528  
Hodges, Luther, 333, 338, 483, 495  
Hoffman, James I., 55, 96n, 110n, 392, 428  
Hoffman, John D.  
    chief of Dielectrics Section, 330  
    chief of Polymers Division, 394  
    dielectric properties of polymers, 200, 392-394



- Hoffman, John D. (*continued*)  
 director, Institute for Materials Research, 469  
 interviews, 66n, 340  
 Laboratory Planning Committee, 478n  
 NIPS proposal, 340
- Hogness, Thorfin R., 158
- Holifield, Chet, 159-163
- Holley, Robert W., 296
- Holloman Air Force Base, 498-500
- Hollomon, J. Herbert  
 Civilian Industrial Technology (CIT),  
 333-337, 340n  
 EEO activities, 317  
 ESSA, 492  
 fire research, 504, 505n  
 on JILA, 329  
 letter from A.V. Astin, 483n  
 memorandum from A.V. Astin  
 ADP Report to the President, 503n  
 Engineering and Commodity Standards  
 Activities, 380  
 Engineering Standards, 381  
 Issuance of Joint NIH-NBS Statement on  
 Open Housing, 472  
 Program for Building Research, 309  
 Proposed Augmentation of 1966 NBS  
 RTS Budget Submission, 502  
 memorandum to A.V. Astin  
 Cryogenics Laboratory, 310  
 NBS and Commercial Laboratories, 381  
 memorandum to J.A. Califano, Jr., 506  
 National Center of Fire Technology, 504  
 National Institutes for Physical Sciences  
 (NIPS), 340-342  
 Planning-Programming-Budgeting (PPB)  
 system, 473  
 resignation, 469
- Hollomon, Margaret, 469
- Honzik, Emilie, 156, 160, 162, 163, 165-166
- Hoover, Herbert, 253, 381
- Hoover, J. Edgar, 165, 166,
- Hoppes, Dale D., 147, 209-212
- Hornig, Donald F., 332n, 462-463, 492
- Horton, Avery T., 471, 583
- Hosler, William R., 561
- hot-wire anemometer, 226, 227
- House Committee on Interstate and Foreign  
 Commerce, report for, 109, 151
- House Committee on Un-American Activities, 13,  
 159, 167, 168, 169
- House Select Committee on Small Business, 104
- House Subcommittee on Science, Research, and  
 Development of the House Committee on  
 Science and Astronautics, 509n
- Housing and Home Finance Agency (HHFA), 255
- Housing and Urban Development Act of 1965,  
 456
- housing systems, 255, 591-592, 595-598
- Howard, Paul L., 2, 97, 99n
- Howard, Paul T., 218
- Hudson, Ralph P.  
 adiabatic demagnetization research, 206, 207  
 demonstration of low temperature equipment,  
 154  
 nonconservation of parity, 147, 207-212  
 nuclear orientation techniques, 208
- Humphrey, Hubert H., 121-123, 339, 456
- Hunt, Franklin L., 57-58
- Huntoon, Robert D., 313  
 Appropriations Hearings for 1961, 349  
 associate director, 176  
 deputy director, 312  
 director of Institute for Basic Standards  
 (IBS), 342, 468  
 Institute for Applied Science proposal,  
 301-302  
 interview, 65  
 mission statement, 310  
 National Measurement System, 31n, 510-512  
 Office of Program Development and  
 Evaluation, 468, 473  
 retirement, 470
- Hurricane Camille, investigation, 594
- Huskey, Harry D., 42n
- Hutchisson, Elmer, 350
- hydraulic testing machine, 366, 367
- Hydraulics Laboratory, 311
- Hydraulics Section, 226n
- hydrogen, impurities in, 220
- hydrogen bomb, 147, 185, 186
- hydrogen cyanide gaseous maser, 396
- hydrogen liquefaction plant, 187
- hydrogen liquefier, 186, 206
- hygrometers, 436

## I

- IBM Corporation, 146, 435
- IDMS technique, 580
- IGY. *See* International Geophysical Year
- incandescent lamps, testing, 27
- indium antimonide, 214
- Industrial Building, demolition of, 474
- Industrial Equipment Technology Division, 344
- inelastic scattering, 568, 569
- Information Technology Division, 344, 503
- infrared spectra of chemical compounds, 222
- infrasonic waves, 390

- inertia-disk dynamometer, 500
- Insecticides, Fungicides, and Rodenticides Act, 293
- Institute for Applied Science proposal, 301-302
- Institute for Applied Technology (IAT), 341-344, 468, 515-518, 521, 590-592
- Institute for Basic Standards (IBS), 342, 343, 468, 521, 560
- Institute for Materials Research (IMR), 342, 343, 468, 521
- Institute for Numerical Analysis (INA), 43, 67, 176, 261, 262, 266
- Institute for Telecommunication Sciences and Aeronomy, 493
- Institute of Metrology (U.S.S.R.), 349
- Institute of Physics (U.K.), 252
- Institute of Radio Engineers, 119n, 177n
- instrument network, National Measurement System, 511
- Instrument Society of America, 192
- Instrumentation Division
  - organizational, 192, 318, 344, 390
  - research, 436-438, 586-588
- instrumentation program, 191-192
- insulation research, 257, 446
- Interagency Committee on Data Processing, 432
- Interdepartmental Committee on Fire Research, 505
- Interdepartmental Committee on Scientific Research and Development, 145
- Interdepartmental Radio Advisory Committee, 376
- Interdisciplinary Research Relevant to the Problems of our Society Program, 464
- interferometers
  - electron-beam, 216, 217
  - Fabry-Perot, 396, 529
  - Michelson, 351-352, 396, 523
- internal friction, study of, 423-424
- Internal Revenue Service, 569
- International Association of Fire Chiefs, 505
- International Astronomical Union (IAU), 324
- International Bureau of Weights and Measures (BIPM)
  - definition of the maintained volt, 538
  - prototype standards, 19, 21, 194, 349-350
  - revisions to the IPTS, 1968, 541
- International Committee for Weights and Measures (CIPM), 372, 386, 538
- International Congress of Radiology, 57
- International Copper Research Association, 429
- International Critical Tables of Numerical Data of Physics, Chemistry and Technology*, 329
- International Electrical Congress of 1893, 22
- international electrical units, 196, 537-538
- International Electrotechnical Commission, 438
- International Geophysical Year (IGY), 272, 275, 288, 438, 439-443
- International Pound, 385-386
- International Practical Temperature Scale (IPTS), 45n, 203-204, 541
- international prototype standards, 19, 21, 194, 394
- International Pyrheliometer Comparison, Third, 549
- International Radio Conference, 375
- International Radio Consultative Committee (CCIR), 273, 375
- International Standards Organization (ISO), 559
- International System of Units (SI), 386-387, 511
- International Telegraph and Telephone Consultative Committee (CCITT), 559
- International Temperature Scale *See* International Practical Temperature Scale
- International Union of Pure and Applied Chemistry, 329, 582
- International Yard, 385-386
- International Year of the Quiet Sun (IQSY), 443
- Interservice Radio Propagation Laboratory, 150, 180, 270-271, 301. *See also* Central Radio Propagation Laboratory (CRPL)
- Interstate Commerce Commission (ICC), 25, 29, 457, 509
- invention and innovation, 515-518
- ion-exchange columns, 220
- ionic conduction, 28-29
- ionosphere, 273, 274, 275, 442-443
- Ionosphere Explorer 1* satellite, 445
- Ionosphere Research and Propagation Division, 318
- Ionospheric Research Laboratory, 67, 272
- Ionospheric Research Section, 272
- IPTS. *See* International Practical Temperature Scale (IPTS)
- IQSY (International Year of the Quiet Sun), 443
- iron, 219, 239
- iron-chromium-nickel-molybdenum system, 239
- iron salts, 82
- Irwin, Lafayette K., 366n
- Isbell, Horace S., 224, 421n
- Ising model, 571
- isothermal distillation, 220
- isotope dilution mass spectrometry (IDMS)
  - technique, 580
- isotope effect, in superconductivity, 44-47
- isotopes, 38
- isotopic abundances, 580-582
- isotopic composition, 215, 550
- Ives, Lewis K., 430n

## J

- Jackson, Henry, 295  
Jacob, François, 296  
Jacobs, Robert B., 186  
Jaffe, Irving, 421n  
Javan, Ali, 528  
Javelin rocket, 444-445  
Jeffries, John T., 324  
Jeffries, Zay, 132  
Jeffries Committee Report, 132-133  
Jennings, Donald A., 281n  
Jespersen, James L., 533n  
jet engines  
    blades, 219, 239, 247, 248  
    combustion and controls, 228  
    fuels, 205-206  
Jet Propulsion Laboratory, 53, 288  
JILA. *See* Joint Institute for Laboratory  
    Astrophysics  
Johnson, Charles M., 280  
Johnson, Daniel P., 318  
Johnson, Edwin C., 182, 184  
Johnson, Lyndon B.  
    attitude toward scientists, 462, 463  
    automatic data processing report, 501  
    Bureau of the Budget report, 501  
    civil rights, 287, 292-293  
    FIPS standards, 559  
    Great Society, 456, 457-458  
    legislation, 506  
    NBS dedication, 489  
    Planning-Programming-Budgeting System,  
        472  
    Vietnam War, 453, 456  
Johnson, Paul (author), 291, 454  
Johnson, Paul B. (governor), 385  
Johnson, Thomas S., 525n  
Johnson, Victor J., 185  
Johnson noise, 541  
Joint Committee on Atomic Energy (Congress),  
    161  
Joint Committee on Chemical Analysis by  
    Powder Diffraction Methods, 252  
Joint Institute for Laboratory Astrophysics  
    (JILA), 170, 322-329  
Joint Resolution of 1836, customary standards,  
    555  
Joint Resolution To promote the maintenance of  
    international peace and security in southeast  
    Asia, 453  
Josephson, Brian D., 297, 538  
Josephson constant, 538-539  
Josephson effect, 297, 538-540, 541

- Josephson junction arrays, 540, 541, 542  
*Journal of Physical and Chemical Reference Data*  
    (JPCRD), 332-333  
Judd, Dean, 301n  
Jupiter, 275, 403  
Jupiter-C rocket, 288

## K

- Kaeser, Robert S., 212n  
Kahan, Daniel J., 429n  
Kamas, G., 533n  
Kamper, Robert A., 541, 542  
Kanagy, Joseph R., 319n  
Kaplan, Joseph, 440  
Karo, H. Arnold, 385n, 492  
Kauai, Hawaii, WWVH, 531  
Kaula, W.M., 525n  
Kearns, Doris, 456  
Kearsley, Elliot A., 390n  
Keller, Andrew, 393  
Keller, W.E., 185n  
Kelly, Mervin J., 119, 130, 171n, 174, 304  
Kelly Committee Report  
    on applied mathematics and computers,  
        261-263, 268-269  
    on the Atomic and Radiation Physics  
        Division, 213, 411  
    on Atomic Energy Commission work, 175  
    on the Building Technology Division, 254  
    on calibrations, 229  
    on the Central Radio Propagation Laboratory,  
        271  
    on the Chemistry Division, 222  
    convertible *v.* nonconvertible funds, 300-301  
    on electrodeposition, 219, 224  
    on the Heat and Power Division, 203  
    impact on NBS, 130-132, 181, 193, 344  
    justification for appropriations increase, 178  
    on materials research, 231-232  
    on measurement mission, 206  
    on the Mechanics Division, 226  
    on the Metallurgy Division, 238, 428  
    on military work, 175, 176  
    on the Mineral Products Division, 246  
    on NBS operations, 173-177  
    on NBS research, development, and technical  
        service capabilities, 113, 130-133  
    on the physical plant, 475  
    recommendations accomplished, 297  
    response of management, 193  
    on testing, 282-283  
*See also* Second Kelly Committee Report

Kelvin, William Thomson, Baron, 26  
 Kelvin scale, 44-45  
 Kendrew, John C., 296  
 Kennan, George, containment of communism, 4  
 Kennedy, Edward M., 464  
 Kennedy, John F.  
     acquiescence to overthrow of Ngo Dinh Diem, 291  
     affirmative action policy, 317  
     assassination, 292  
     automatic data processing review, 501  
     Bay of Pigs invasion, 287, 289  
     civil rights, 291, 292  
     consumer rights, 457  
     Cuban missile crisis, 289-290  
     science advisors, 295  
     space race, 288-289, 295, 445, 460  
     White House Panel on Civilian Technology, 333  
 Kennedy, Robert F., 287, 455, 456  
 Kent, Morton E., 165  
 Kerst, Donald W., 56  
 Kessler, Karl, 405  
 Khoury, Freddy A., 425n  
 Kieffer, Lee J., 554  
 Killian, James R., Jr., 146  
 kilogram, standard, 19-20, 21, 226, 229  
 Kimberly, Arthur E., 49  
 Kincaid, John F., 469, 519  
 kinetic theory, 569-572  
 King, Martin Luther, Jr., 142, 287, 291, 292, 455  
 Kinzel, Augustus, 304n  
 Kirby, Richard C., 317  
 Kirkwood, John G., 132n  
 Kirstein, Arthur F., 366n  
 Kispert, M.G., 105n, 108n  
 Kistiakowsky, George B., 462  
 Klein, J.A., 280  
 Klein, Ralph, 421n  
 Kline, Francis J., 565n  
 Kline, Gordon M., 50, 319, 394  
 klystron frequency, 528  
 Knecht, Robert W., 444n  
 Knight, James, 567  
 Knight shifts, 429  
 Knowland, William, 90-92  
 Koonce, Calvin S., 561, 562, 563  
 Korea, Republic of, 6  
 Korean War, 6, 7, 16, 137-139  
 Kornberg, Arthur, 147-148, 296  
 Kotter, F. Ralph, 478n  
 Kowalski, Stanley, 565n  
 Kropschot, Richard H., 186  
 Kruger, Jerome, 426, 427, 428

Krushchev, Nikita S., 141, 289, 290  
 krypton-86 lamp, 351, 352  
 krypton-86 standard of length, 194, 349-350  
 Kurti, Nicholas, 206, 208  
 Kusch, Polykarp, 369  
 Kushner, Lawrence M.  
     chief of Metallurgy Division, 319  
     deputy director of NBS, 470  
     Institute of Applied Technology, 468, 469  
     Laboratory Planning Committee, 478n  
     Metal Physics Section, 238, 428  
 Kuyatt, Chris E., 409

## L

Laboratoire de l'Accélération Linéaire, Orsay, France, 565  
 Laboratoire Suisse de Recherches Horologères, 374  
 laboratory astrophysics, 403-404  
 laboratory blackbody, 545, 546  
 Laboratory Planning Committee, 478, 480, 487n  
 Lafferty, Walter, 410  
 Laidler, Keith J., 104, 107-109, 127, 134  
 Lamb, Willis, 10-11  
 Lamb shift, 11  
 LaMer, Victor K., 132n  
 Lamm, Ralph A., 18  
 lamp standards, 547  
 Lance, Harvey W., 378  
 Landon, Harry H., 414, 567  
 Langmuir, Robert V., 405n  
 Lapp, Claudio J., 190  
 laser-ranging, 526  
 lasers for length measurements, 351-353, 522-529  
 Lattice Defects and Microstructure Section, 428  
 Lauritzen, John I., Jr., 393n, 394  
 Law, C.A., 55n  
 Lawrence Berkeley Laboratory, 447  
 lead isotopic composition standards, 550  
 lead-silica glass standard sample, 550  
 lead titanate-lead zirconate system, 250  
 leap seconds, 374  
 leather, studies of, 234-235  
 Leather Section, 232, 319n  
 Lederman, Leon M., 212n  
 Leedy, H.A., 304  
 Lee, Richard, 205  
 Lee, Thomas G., 451n  
 Lee, Tsung Dao, 147, 207-208, 212  
 legislation  
     automobile safety, 495-498  
     fire safety, 505-507

legislation (*continued*)  
 Great Society, 456-459  
 NBS responsibilities, 493-494  
 for state weights and measures, 384  
 Legislative Reference Service, *Technical Information for Congress, Report to Subcommittee on Science, Research, and Development of the Committee on Science and Astronautics, U.S. House of Representatives, 91st Congress, April 15, 1969, Chapter Three—AD-X2: The Difficulty of Proving a Negative*, 127  
 Lehman, Herbert H., 101-102  
 Leipper, Dale F., 304  
 LeMay, Curtis E., 7  
 length standards, 37-40, 345-353, 522-524, 526-527  
 Leopold, L.B., 311  
 lepton particles, 296  
 Letter Circular 302, *Battery Compounds and Solutions*, 83, 93, 99  
 Letter Circular 586, *List of Publications of Interest to the General Public*, 72  
 Letter Circular 696, *List of Publications of Interest to the General Public*, 72  
 Levine, Samuel, 421n  
 levulose, 223n  
 Lewett, George P., 517  
 Lewis, G.N., 87  
 Libbey-Owens-Ford Company, 51  
 Libby, Willard, 11, 147  
 library, NBS, 486, 490-491  
 Library of Congress, Charters of Freedom, 47, 49, 50, 53  
 Lick Observatory, 526  
 Lide, David R., Jr., 332, 410  
 light as a standard, 37-40, 194, 278-281, 349-353  
 Lightbody, John W., Jr., 564, 565  
 Lilienthal, David E., 165  
 linear accelerator (LINAC), 412, 415-419, 563-565  
 Lippincott, Ellis R., 357  
 Lippman, Walter, 454  
 liquid deuterium, 185, 186  
 liquid hydrogen, 445-447  
 liquid-level indicator and control system, 195  
 liquid-scintillation counters, 216  
 liquids, flow in, 228  
 lithium deuteride (LiD), 186  
 lithium diffusion in germanium, 589  
 Little, C. Gordon, 318, 342, 468  
 load failure of building structures in a fire, 452  
 Loftus, Joseph J., 451  
 Longsworth, Lewis G., 132n

LORAN (Long Range Navigation) tables, 264  
 low-temperature physics research, 206-213  
 loyalty investigations, 13, 70  
 Lubbock, Texas, tornado, 593-594  
 Lüders, Gerhart, 212, 296  
 luminous intensity, 546  
 lunar distance determination, 525  
 lunar landings, 295, 445, 460  
 Lunik II satellite, 295  
 Luther, Gabriel G., 529  
 Lyklema, Johannes, 554  
 Lyons, Harold A., 12, 368n

## M

MacArthur, Douglas, 138-139  
 MacDonald, G.J.F., 525n  
 Machine Development Laboratory, 261  
 machine translation, 431, 432  
 Macromolecules: Synthesis and Structure Section, 319n  
 macroscopic single crystals, 214  
 Madden, Robert P., 405-407  
 Maginot line, 75  
 magnetic drum memory, 267, 269  
 magnetic fluid clutch, 35, 36  
 magnet technology, cryogenic, 448-449  
 Magnuson, Warren, 458  
 Maiman, Theodore H., 296  
 maintenance of the volt, 537-540  
 Maki, Arthur, 410  
 Malenkov, Georgi M., 141  
 Mallinger, Arnold J., 365  
 Malmberg, Cyrus G., 130n  
 Manhattan Project, 157, 219n, 580  
 Manley, John, 65n  
 Mann, David E., 188, 189, 190, 318, 421n  
 manned lunar landings, 295, 445  
 Manning, John R., 429, 554  
 Mao communism, 4  
 Maritime Administration, 304n, 509,  
 Markowitz, W., 373n  
 Marlow, William F., 216  
 Mars, 403  
 Marshall, George C., 139-140  
 Marshall, Richard E., 464  
 Marshall Plan, 4  
 Martin, William C., 403n, 554  
 Marton, Claire, 218n  
 Marton, Ladislaus L. (Bill), 216, 218n  
 Maruyama, Xavier K., 565n  
 Marvin, Robert S., 204-205, 318

- Mass and Scale Section, 318  
mass measurements, 533-537  
Mass Section, 229  
mass spectrometers, 580, **581**  
mass spectrometry, 215, 220, 580  
Mass Spectrometry Section, 318, 421n  
mass standards, 555-558  
Massachusetts Institute of Technology (MIT),  
105, 107-110, 565  
master index plate, **388**  
Matarrese, L.M., 528n, 529n  
materials research, 231-232, 421  
    cryogenics industry, 446-449  
    Inorganic Solids Division, 422-424  
    Metallurgy Division, 27, 238-240, 426, 427,  
    428-430  
    Mineral Products Division, 27, 246-253,  
    422-424  
    Organic and Fibrous Materials Division, 27,  
    232-237, 424-427  
    Polymers Division, 424-427  
    Ship failures, 240-246  
mathematical analysis in mathematical physics,  
266  
Mathematical Physics Section, 262, 266  
mathematical tables, calculation of, 264  
Mathematical Tables Project, 40-41, 264  
Mathusa, Jesse L., 113n  
matrix inversion, 263  
mattresses, cigarette ignition, 259  
Mauchly, John W., 11, 41  
Maui, Hawaii, WWVH, 531  
Maxwell, Emanuel, 46, 47, 206  
May, Elaine Tyler, 137  
Mayall, R. Newton, **485**  
Mayer, Joseph E., 132n  
McBurney, John W., 103n  
McCarthy, Eugene, 455  
McCarthy, Joseph, 139-141  
McCarthyism, 5, 70, 139, 140  
McClellan, Delmar W., 53  
McClellan, John L., 339, 513n  
McDonald Observatory, 526  
McGovern, George, 456  
McIntyre, Donald, 319n  
McKinley, Clyde, 308n  
McLane, Lewis, 555  
McLeish, Archibald, 49  
McMahon, Brien, 157  
McMurdie, Howard F., 358  
McNish, Alvin G., 183, 318  
McPherson, Archibald T., 107n, 176  
Meal, Janet Hawkins, 190  
mean-field theories, 570  
Mearns, David C., 48n  
Measurement Assurance Program (MAP), 533  
537, 540  
Measurement Standards Laboratory, 67, 272  
measurements  
    absolute, 197  
    calibration and, 37, 377-379  
    color, 194  
    electrical, 196-200, 542-544  
    electron energy loss, 216  
    graphite for nuclear reactors, 251  
    isotopic composition, 215  
    large forces, 362-367  
    laser frequency, 527-529  
    length, 37-40, 345-353, 522-527  
    mechanical properties of materials, 226  
    noise level, 228  
    optical radiation, 548  
    physical properties of glasses, 249  
    pressure, 229, 355-362  
    radiation intensity, 545  
    radiative emissivity of building structures,  
    257  
    in radioactivity, 215  
    radio propagation, **276**, 277  
    radio standards for, 277, 395  
    silicon resistivity, 586-588  
    smoke density, 597-598  
    sound and vibrations, 226, 228-229  
    spectral lines, 403  
    speed of light, 278-281, 396  
    standard weights and measures for the states,  
    382-385  
    temperature, 203-204, 353-355, 541-542  
    thermal conductivity, 220, 450  
    thermal properties of matter, 204-205  
    time and frequency, 367-377  
    tracer gas, 257  
    uniformity of, 32  
    water-vapor permeability of materials, 234,  
    258-258  
    *See also* calibrations; standards  
Mechanical Instruments Section, 192n, 226n, 318  
Mechanical Metallurgy Section, 238, 428  
mechanical standards, 226  
Mechanics Division  
    measurement standards, 389-390  
    organizational changes, 318  
    pressure calibration services, 356  
    research, 226-230  
    ship failures, 242, 243  
mechanized production of electronics (MPE),  
201, 202  
Medlock, Robert W., **216**

Meggers, William F., 37n, 38–39, 324  
 Mehl, Robert F., 119n  
 Meinke, W. Wayne, 380, 420  
 Meissner, Walther, 45  
 Meissner effect, 562  
 Melting points of polymers, 393–394  
 Menzel, Donald H., 119n  
 merchant ships, failure of, 242–246  
 mercury-198 lamp, 39  
 Mercury Control Center, Cape Canaveral, 445  
 mercury line, compared to cadmium line, 40  
 mercury-silver amalgam for dental fillings, 237  
 Meredith, James, 291  
 Mergenthaler Linotype Company, 435  
 Meschke, Ray, 567  
 metal crystals study, 428–429  
 Metal Physics Section, 238, 319, 428  
 Metallurgy Division, 27, 29, 231–232  
     cryogenic magnet technology, 448  
     electrodeposition, 218–219  
     ellipsometry, 426  
     gage blocks, 346–349  
     organizational changes, 318, 319, 419  
     Point Pleasant Bridge collapse, 576–579  
     research, 238–240, 428–430  
     ship failures, 240–246  
 meter, standard, 19–20  
 Metric System Study, 466, 493, 494  
 Metrology Division, 318, 387  
 metrology training center, 384  
 Meyerson, Melvin R., 346, 347, 577  
 Michelson, Albert A., 37–38  
 Michelson interferometer, 351–352, 396, 523  
 microphones, calibration of, 228  
 microwave spectroscopy research, 410  
 Microwave Standards Section, 272  
 microwaves, 275  
 Mielczarek, Stanley R., 407n, 409n  
 Mielenz, Klaus D., 524  
 military tests on AD-X2, 93  
 military work, WW II, 16n  
 Miller, John M., 197n, 198  
 Mineral Products Division, 27, 231–232, 319,  
     246–253, 422–424  
 Minesinger, R.R., 450n  
 Minuteman missile, 288  
 Missile Instrumentation Section, 192  
 missiles, 18, 264, 182, 427  
 Mitchell, Neal, 591  
 Mixture C. *See* Battery AD-X2  
 mobile research unit, 276  
 Modern Waterproofing Paint Company, 76, 77  
 modular design of electronics (MDE), 201, 202  
 molybdenum, electrodeposition of, 225

molecular clock, 12, 368  
 molecular genetics, 11  
 Molecular Kinetics Section, 318, 421n  
 molecular sieve, 224  
 molecular spectroscopy research, 410  
 Molecular Spectroscopy Section, 318, 421n  
 Molecular Structure and Properties of Gases  
     Section, 421n  
 molecular weight, determination of, 224  
 Molotov, Vyacheslav M., 141  
 molybdenum, electrodeposition, 225  
 Mondale, Walter, 458  
 Monod, Jacques, 296  
 Monte Carlo methods, 44, 263  
 Montgomery, G. Franklin, 192, 318, 586n  
 Montgomery County, Maryland, 471–472, 509  
 Montoya, Joseph, 458  
 Moore, Dwight, 249  
 Moore, Larry J., 581n  
 Moore Sitterly, Charlotte E., 324, 554  
 Morgan, Alvin H., 532  
 Morley, Edward W., 37–38  
 morphological stability theory, 429  
 Morrison, Philip, 9  
 Moscow Planetarium, 144  
 Moses, Lincoln E., 566  
 motor truck speed governors, testing, 35  
 Mountain, Raymond D., 572  
 Moyer, James W., 400n  
 MPE wafer pattern printer, 201  
 Muehlhause, Carl O., 413, 414, 567  
 Mueller, Frederick H., 304, 385n  
 muffle furnace, 451  
 Mulholland, J.D., 525n  
 Mullen, Lewis O., 542  
 Mulligan, Joseph F., 278  
 multiple radiation scattering calculations, 412  
 Mundt, Karl, 141  
 muon particles, 296  
 Murdock, Harris H., 76, 79  
 Murphy, Thomas J., 581n

## N

Nachtman, Otto, 213  
 Nader, Ralph, 458, 459, 462  
 National Academy of Engineering (NAE),  
     509–510  
 National Academy of Sciences (NAS)  
     Building Research Advisory Board, 336  
     Charters of Freedom, 48  
     evaluation of NBS research, development,  
     and technical service capabilities, 113,  
     130–133, 509–510

National Academy of Sciences (*continued*)

- International Geophysical Year, 439
- NRC-NBS postdoctoral research associates, 188-191
- Office of Critical Tables, 329
- recommendation for A.V. Astin as director, 171
- Space Science Board, 294, 323
- study of science and technology in Dept. of Commerce, 304

National Advisory Committee for Aeronautics (NACA), 204, 226, 288

National Aeronautics and Space Act of 1958, 288

National Aeronautics and Space Administration (NASA)

- CRPL space technology, 445
- formation of, 288
- mathematical physics studies, 430, **431**
- polymer degradation studies, 426-427
- retroreflector experiments, 526
- silicon resistivity, 586

National Applied Mathematics Laboratories (NAML), 42, 261-262, 268

National Archives, Charters of Freedom, 48, 53

National Better Business Bureau (NBBB), 83, 92-93, 94-95, 96-99

National Bureau of Standards (NBS)

- accuracy and uniformity, 26, 27
- aerial photographs, **15**, **183**, **486**
- anniversary, fiftieth, 2, 153-154
- arbitrational v. regulatory responsibility, 24-26
- awards, 313-317
- Boulder Laboratories, 182-188, **189**
- Boulder-Washington relations, 319-322
- budgetary matters, 177-181, 298-303, 466-467
- colloquia, 70
- cooperation between scientists, 64-65
- corporate laboratory, 34
- description, 14-18, 23, 33, 137, 465-466
- EEO, 317, 470-472
- evaluation panels, 113, 130-133, 509-510
- field stations, 14-15, **16**, 246, 272, **274**
- formation of, 1, 19
- Gaithersburg facilities, 474-491
- growth, 297-298
- leadership (1964), 468-470
- loyalty investigations, 13, 70
- mission, 21, 33-34, 152-153
- organizational structure (1950), 17-18
- project criteria, 181
- publications, 35-36, 71-74, 162n
- regulatory responsibility, 260

National Bureau of Standards (*continued*)

- reorganization, 1964, 338-345
- research funds, 179
- Senior Lunch Club, **69**
- South Building, 69
- technical symposia, 153-154
- technical work, 34-37
- Visiting Committee, 113, 119-120, 130, 149
- Washington, D.C. campus, 14, **15**, 64
- Working Capital Fund, 180
- working environment, 62-70

*See also names of specific divisions or sections*

National Bureau of Standards Reactor (NBSR), 413-415, 488, 567-569

National Capital Parks Police, tire wear tests, 35

National Center of Fire Technology, 310, 504

National Commission on Fire Prevention and Control, 507

National Commission on Product Safety, 459, 493, 506

National Conference of Standards Laboratories (NCSL), 285, 378-379, 512

National Conference of State Building Codes and Standards, 31, 32

National Conference on Weights and Measures, 31, 32, 177n, 384

National Council of American-Soviet Friendship (NCASF), 163

National Cryogenic Data Center, 309

National Defense Research Committee (NDRC), 7, 156, 157

National driver register, 496

National Environmental Science Service, 493

National Environmental Services Administration, 492

National Fire Protection Association, 505

National Foundation on the Arts and the Humanities, 456

National Gas Pipeline Safety Act of 1968, 458

National Highway Safety Bureau (NHSB), 497

National Hydraulics Laboratory, 305, 311

National Institute for General Medical Sciences, 551

National Institute of Building Research, 309

National Institute of Standards and Technology (NIST), 342

National Institutes for Physical Sciences (NIPS), 338-342

National Institutes for Science and Technology (NIST), 342

National Institutes of Health (NIH), 9, 551

National Inventors Council (NIC), 515-517

National laboratories, 6-7



- National Measurement System, 31n, 510–512, 588
- National Motor Vehicle Safety Advisory Council, 496
- National Physical Laboratory (U.K.), 39
- National Research Council (NRC)  
 Building Research Advisory Board, 336  
 evaluation of NBS research, development,  
 and technical service capabilities, 509–510  
 infrared spectra data, 222  
*International Critical Tables of Numerical  
 Data of Physics, Chemistry and  
 Technology*, 329  
 NRC-NBS postdoctoral research associates,  
 189–190  
 Office of Critical Tables, 329
- National Research Foundation, 8
- National Science Foundation (NSF)  
 charter revised, 464  
 education of scientists, 145  
 establishment of, 8, 145, 294  
 Interdisciplinary Research Relevant to the  
 Problems of our Society program, 464  
 International Geophysical Year, 439  
 JILA funding, 327n  
 mission, 152, 339  
 R&D expenditures, 143n  
 Research Information Center and Advisory  
 Service on Information Processing, 436  
 structure of, debates, 10
- National Standard Reference Data System  
 (NSRDS), 222, 329–333, 511, 553–554
- National Technical Information Service (NTIS),  
 515
- National Traffic and Motor Vehicle Safety Act of  
 1966, 458, 466, 496, 497
- National Transportation Safety Board (NTSB),  
 458, 576
- Natta, Giulio, 147
- natural polymers, 232, 234, 424
- natural-ratio isotopic composition standards, 550
- natural rubber, 232, 233, 234
- natural standards v. artifacts, 37–40
- Naval Board of Investigation, 242, 243
- Naval Medical Center, 264
- Naval Observatory, 374
- Naval Ordnance Laboratory (NOL), 568
- Naval Research Laboratory (NRL), 561
- NBS I, atomic clock, 370
- NBS II, atomic clock, 371
- NBS atomic clocks, 368–372
- NBS/GSA Test Development Division, 381
- NBS Safety Award, 316
- Ne'eman, Yu'val, 296, 412
- Nefflen, Karl F., 351
- negative ion states, 409
- Nelson, Gaylord, 458
- Nesbitt, Lloyd B., 46, 47
- Nethercot, Arthur J., Jr., 280
- Neumann, John von, 11
- neutrino observatory, 464
- neutrinos, 296
- neutron flux measurements, 551
- New York Quartermaster Purchasing Agency, 265
- Newhouse, John, 65n
- Newton, Quigg, 326
- Newton apple tree, 474, 490
- Ney, Wilbert R., 346n
- Ngo Dinh Diem, 291
- Nicholas, Warren W., 61
- nickel studies, 238
- night airglow, 276
- NIPS. *See* National Institutes for Physical  
 Sciences (NIPS)
- Nirenberg, Marshall, 296, 464
- nitrogen tetroxide, effects on natural cellulosic  
 fibers, 236
- Nixon, Richard M., 5, 170, 456, 463, 521
- Nobel Prize, 11n, 207
- noble gases, study of absorption spectrum, 407
- noise measurements, 228, 274–275
- nonclassical scaling laws, 572
- nonconservation of parity in weak interactions,  
 207–213
- nonconvertible funds, 300–301
- nonlinear differential equations, 264
- nonlinear theory of viscoelastic substances, 390
- nonrotating projectiles proximity-fuze program, 65
- North Atlantic Treaty Organization (NATO), 4
- North Korea, 6, 137–139
- Northeast Corridor, transportation study, 508
- Norton, Kenneth A., 183
- NSRDS. *See* National Standard Reference Data  
 System (NSRDS)
- NSRDS 60, *Atomic Energy Levels—The Rare  
 Earth Elements*, 403
- nuclear magnetic resonance of metals and alloys,  
 429
- nuclear quadrupole moments, 215
- nuclear radiation detectors, 588–589
- nuclear reactor, NBS, 413–415, 483, 567–569
- nuclear reactors, coatings, 247, 248
- nuclear reactors, preparing pure mercury, 38
- nuclear structure research, 411
- Numerical Analysis Section, 262
- numerical evaluation of integrals, 263
- Nutting, Perley G., 545

## O

- Oakford, Robert V., 566
- Oakland Better Business Bureau (OBBS), 89, 90, 94
- Oakley, Charles H., 25
- oblateness of Earth, calculating effects of, 430, 431
- O'Brien, J.T., 565n
- O'Brien, W.C., 110, 111
- occupant restraint systems, 498-500
- ocean-based weather station, 437
- Ochoa, Severo, 147, 296
- Ochsenfeld, R., 45
- O'Connell, Maurice, 2
- O'Connor, Blake
- career impact of Battery AD-X2 controversy, 134
  - correspondence with J.A. Stratton, 105, 109
  - meetings with A.V. Astin, 107-108
  - POD fraud order, 111, 113
  - SSCSB, 105
- octane-number rating of gasoline engine fuels, 205
- Odishaw, Hugh, 66, 439n
- Oehme, Reinhard, 212
- Office of Auto Safety Research, 497
- Office of Basic Instrumentation, 192, 318, 436
- Office of Civil and Defense Mobilization, 309, 412
- Office of Critical Tables, NAS-NRC, 329
- Office of Defense Mobilization (ODM), 146
- Office of Energy-Related Inventions, 517
- Office of Engineering Standards, 343-344, 382
- Office of Equal Opportunity, 470
- Office of Fire Research and Safety, 507
- Office of Industrial Services, 343
- Office of Information Processing Standards, 559
- Office of Information Programs, 514
- Office of International Relations, 514
- Office of Invention and Innovation (OII), 515-518
- Office of Management and Budget (OMB), 560
- Office of Naval Research (ONR), 10, 41-42, 47, 192, 575
- Office of Program Development and Evaluation, 473
- Office of Public Information, 514
- Office of Science and Technology (Department of Commerce), 381
- Office of Science and Technology (OST, Executive Office of the President), 295
- Office of Scientific Research and Development (OSRD), 7, 40-41, 65, 145, 331
- Office of Standard Reference Data (OSRD), 331, 343, 514, 553
- Office of Standard Reference Materials (OSRM), 343, 380, 521, 550
- Office of Technical Information and Publications, 514
- Office of Technical Services (OTS), 304n, 343, 513
- Office of Technology Innovation, 517
- Office of the Air Controller, 265, 267
- Office of the Army Chief of Engineers, 257, 258
- Office of the Director of Defense Research and Engineering, 294
- Office of Transportation, Northeast Corridor study, 508
- Office of Vehicle Systems Research (OVSR), 497-500
- Office of Weights and Measures (Coast and Geodetic Survey), 385
- Office of Weights and Measures (OWM, National Bureau of Standards), 20, 21, 343, 382
- Ohm's law, 537
- Okabe, Hideo, 422
- Olsen, P. Thomas, 540
- Olson Construction Company, 188
- omegatron, 55
- OMNIFORM I computer program, 433-434
- OMNITAB computer program, 433-434
- Ondik, Helen M., 554
- O'Neill, William L., 142
- Onnes, Kamerlingh, 45
- Onsager, Lars, 571
- Operation Breakthrough, Housing and Urban Development, 592
- Operation Crossroads, 158
- operations research, 265, 431, 507-509
- Oppenheimer, Robert, 14
- optical glass, 248
- optical radiation measurements, 548
- Optics and Metrology Division, 193-194, 239, 318, 346-347, 387-389
- Optics Division, 213
- Ordnance Development Division, 172
- Organic Act
- in 1901, 23-24
  - 1950 revision of, 149-153, 282
  - advisory service to Government agencies, 268-269
  - functions, 19, 23-24, 175n
  - measurement standards, 30-31
  - Public Law 84-940 (Working Capital Fund), 178
- Organic and Fibrous Materials Division, 27, 232, 237, 319, 392, 424-427
- Organic chemistry research, 222-224
- Organic Chemistry Section, 421n

Organic Coatings Section, 218, 318  
Organic Plastics Section, 232  
Organization of American States, 516  
Ornstein, Leonard S., 571  
orthophosphates, crystal structure, 252  
Oscilloscope, compact, 195  
other agency (OA) funds, 15n, 30, 179-180,  
300-302  
Ottinger, Richard, 458  
Overman Act, 30  
over-water tropospheric propagation, 276  
ozone, effects on cotton, 236

## P

Page, Chester H., 317, 386  
Pais, Abraham, 11n  
Panel on Invention and Innovation, 515, 516  
panoramic x-ray machine, 237  
paper, durability studies, 235-236  
Paper Section, 232, 319  
parity, nonconservation experiment, 207-213  
Parker, James W., 131n  
Parry, J.V.L., 373n  
Parsons, Douglas E., 74n  
particle physics, 296, 412, 464  
Passaglia, Elio, 319n, 426, 577  
passive films, 428  
patent activities, modeling, 508  
Patent Office, 48, 304n, 508  
Pauli, Wolfgang, 212, 296  
Paulsen, Paul J., 581n  
Peagram, George B., 168-169  
Pearson, Cornelius, 250  
Pearson, Drew, 115  
Peiser, H. Steffen, 318, 424, 535, 582-583  
Pellam, John R., 206, 399  
Pellat balance, 198-200  
Penner, Samuel, 563, 564, 565  
Penzias, Arno A., 464  
Pereira & Luckman (architectural firm), 184  
permanent-press clothing, 295  
performance concept, Building Research Division,  
590-592  
Performance Test Development Division, 344  
permeability of free space, 537  
permutation tables, 566  
Perutz, Max, 296  
Peterson, Esther, 458  
petroleum industry, 32, 194  
Pfeiffer, Earl R., 561, 562  
Pfeiffer, John E., 10n  
phase diagrams, 239, 252-253

*Phase Diagrams for Ceramists*, 252  
phase transitions in polymer mixtures, 572  
Phelan, Robert J., Jr., 548n  
photodetachment of electrons from negative ions,  
403  
photoelectric pyrometer, 205  
photoelectric spectrometer, automatic scanning,  
220  
photographic dosimetry, 411  
photography, practical work, 194  
photometric standards, 387-388, 546  
photometry, 544, 546  
photometry laboratory, 23  
photometry of mercury-vapor lights, 194  
photonuclear data, 554  
photonuclear research, 59, 215  
physical chemistry, 218  
Physical Chemistry Division, 318, 343, 419, 421  
Physikalisch-Technische Bundesanstalt (PTB),  
349, 524  
Physikalisch-Technische Reichsanstalt (PTR), 19,  
22, 546  
physiological monitor, 195, 196  
Picatinny Arsenal, 568  
Pierce, John A., 375  
Piermarini, Gasper J., 358, 360-361  
piezoelectric work, 250-251  
PILOT computer, 433  
Pilot Program in Mass, 535  
Pioneers, Inc., 88, 94, 103, 104. *See also* Ritchie,  
Jess M.  
Pitzer, Kenneth S., 131n  
PL-480 money, Special Foreign Currency  
Program, 303  
Planck, Max, 545, 546, 548  
Planning-Programming-Budgeting (PPB) system,  
472-474  
plasma, blood substitute, 224  
plasma arc apparatus, 354  
plasma oscillations, 275  
plasma physics, 430  
plastic deformation of metals, 239  
plastics, studies of, 232, 233  
Plastics Section, 319n  
platinum blackbody, 387-388, 389  
platinum-iridium kilogram, 19-20, 21, 226, 229  
platinum-iridium meter bar, 37, 194  
Plotkin, H.H., 525n, 526n  
Plyler, Earle K., 279, 280, 410  
Point Pleasant Bridge collapse, 576-579  
polarimetry, determining sugar content of  
solutions, 224  
Polaris missile, 288  
Polaris submarine, 146

- polar missile attack warning system, 254  
 Policy Committee for Mathematics, 177n  
 polio vaccine, 147  
 Polk, Louis, 350  
 Pollock, Clifford R., 281n  
 pollution control, 293  
 pollution studies, 28, 220  
 Polychlorotrifluoroethylene (PCTFE), 392-393  
 polycrystalline ceramics at high temperatures, 251-252  
 polyisobutylene, 233  
 Polymer Characterization Section, 319n  
 polymer chemistry, 224  
 Polymer Chemistry Section, 319n  
 polymer crystals, 393-394  
 Polymer Evaluation and Testing Section, 319n  
 Polymer Physics Section, 319n  
 polymer research, 232-237, 392-394, 425-426, 571  
 Polymer Structure Section, 232, 392  
 polymers, melting point, 393-394  
 Polymers Division, 200, 319, 394, 424-427,  
 polystyrene-cyclohexane solutions, 571  
 Pontius, Paul E., 534  
 Poorman, Fred S., 478n, 482  
 Porcelain and Pottery Section, 246  
 porcelain-coated metals, 247, 248  
 Portland Cement Association, 247  
 postdoctoral research associates, 188-191  
 Post Office Department (POD)  
   Battery AD-X2  
     complaint against Pioneers, Inc., 103  
     fraud hearings, 110-111  
     fraud order, 111, 128  
     NBS tests for, 83, 102  
   cost-benefit analysis, 509  
   mail fraud concerns, 282  
   mail handling, 436  
   NBS testing for, 71  
   nuclear reactor forensic work, 569  
   tire wear tests, 35  
 Postulate of Measurement, 534  
 postwar America, 137-143  
 postwar chemical industries, 222  
 Poultney, S.K., 525n  
 pound, refining values for, 385-386  
 pound-force, defining, 365  
 Powell, Robert L., 186  
 Powers, Gary, 287, 289  
 Powers, Joseph W., 103n  
 Pratt Institute, School of Architecture, 595-596  
 precision balance, 556  
 predictive analysis system, 432  
 President's Commission on the Patent System, 516  
 President's Committee on Consumer Interests, 458  
 President's Science Advisory Committee (PSAC), 146, 294  
 Pressure and Vacuum Section, 318  
 pressure measurements, 229, 355-362  
 Preston, Prince H., 179, 299, 477, 482  
 Price, Don K., 7  
 Priestley, H., 407n  
 Prima Products, Inc., 78n  
 primary standard kilogram, 19-20, 21, 226, 229  
 prime numbers, 263  
 private standards laboratories, 285  
 product testing  
   end of, 380-381  
   examples of, 34-35  
   of government purchases, 27, 246, 247, 282-284  
   Kelly Committee Report, 282  
   for private individuals, 75  
   and publications, 71-74  
   for regulatory agencies, 71, 73, 282  
   *See also* Aquella; Battery AD-X2  
 profiling procedure, 432  
 Project Tinkertoy, 195, 200-203  
 Prosen, Edward J., 421n  
 Protecto-Charge, 87-89, 121-123. *See also*  
   Battery AD-X2  
 proton gyromagnetic ratio, 391-392  
 proton precession frequency, 55n, 391-392  
 proving ring, million-lb capacity, 365  
 proximity-fuze program, 65  
 proximity fuzes, 219  
 Proxmire, William, 458  
 Pruitt, John S., 411n  
 Pryce, Maurice H.L., 208  
 Public Buildings Service (PBS), 476, 479  
 public opinion, Battery AD-X2, 115-118  
 Publication Board, 513  
 pulsed lasers, 522  
 Pure Food Act, 457  
 pure materials, preparation, 239  
 Pure Substances Section, 419  
 purification methods, 219-220, 221  
 pursuit cars, testing, 35  
 pyrhelimeter, 549
- ## Q
- QSL cards, 530  
 quantum electrodynamics, 11  
 quantum Hall effect, 540  
 quantum mechanical systems, 207n  
 quasar discovery, 295-296  
 Quick, G. Willard, 240

## R

- Rabi, I.I., 65n, 146, 369
- Rabinow, Jacob  
     Bureau life, 63  
     magnetic fluid clutch, 36  
     memorandum on security problems, 167  
     National Inventors Council, 515, 516n, 517n
- Raby, Tawfik, 567
- racial violence, 454, 455
- racism, 142
- Radebaugh, Ray., 541n
- radiation, 56, 212, 214, 545
- Radiation Control for Health and Safety Act of 1968, 459, 466
- radiation detectors, 588–589
- radiation intensity detectors, 545
- Radiation Physics Division, 318, 411–412, 415–419, 503
- Radiation Physics Laboratory, 59, 213, 482
- radiation theory, 412
- Radiation Theory Section, 212
- Radiation Thermometry Section, 541
- radiative emissivity of building structures, measurement, 257
- radio carbon dating, 11, 380
- Radio Communications and Systems Division, 317
- radio-frequency standards, 272, 374–377, 542–544
- radio noise, 273–275, 443
- radio operators, 530
- radio propagation, 14, 272–273, 445
- Radio Propagation Engineering Division, 181, 272, 438
- Radio Propagation Physics Division, 181, 272, 318, 438, 440
- Radio signals, 276
- Radio Standards Division, 181, 272, 277, 395–398
- Radio Standards Engineering Division, 318, 343
- Radio Standards Laboratory, 318, 319, 375
- Radio Standards Physics Division, 318, 343
- radio stations  
     WWV, 14–15, 17, 272, 274, 374–375, 529, 530, 531, 533  
     WWVB, 375, 376–377, 529  
     WWVH, 14–15, 272, 274, 375, 531–532  
     WWVL, 376–377, 529
- radio weather forecasts, 150, 270–271
- radio weather prediction service, 67
- radioactive fallout patterns, 267
- radioactive isotopes, 215
- radioactive sugars, 222–224
- radioactivity, 21, 215
- Radioactivity Section, 213, 216
- radioactivity standards, 411, 412
- Radiological Society of North America, Standardization Committee, 57–58
- radiometry, 544–549
- Radiometry Section, 213
- radium, 32, 35, 215
- radium gamma-ray standards, 32
- radon standards, 32, 35
- railroad accidents, study of materials, 29–30
- railway-scale test car, 25
- Ramberg, Walter, 226, 301n
- Ramsey, Norman F., 369n
- Ramspeck Act, 317
- Randall, Merle  
     “6 Reasons Why You Should Use Battery ‘Protecto-Charge’”, 88  
     correspondence with E.U. Condon, 90, 92, 94  
     correspondence with G.W. Vinal, 87, 89  
     death, 100  
     and G.N. Lewis, *Thermodynamics and the Free Energy of Chemical Substances*, 87
- Randall Test, 89, 103
- random number generating, 263
- random permutation, 566
- Rank, David H., 280
- Rapp, W.F., 508, 514
- rational approximations, 264
- Ray, James Earl, 455
- ray-tracing in lens design, 194
- Raybold, Robert C., 534
- Rayleigh current balance, 197, 198
- Raytheon Company, 42
- RCA 501 computer, 295
- Reactor Radiation Division, 503, 568
- Reactor Radiations Division, 343, 503
- Read, Michael E., 429n
- real-time television, 295
- Ream, Norman J., 503
- reference materials. *See* Standard Reference Materials (SRMs)
- reflective insulation, 257
- Refractories Section, 246
- refrigerated trailer trucks, 256–257
- refrigeration processes, 446
- refrigerator safety devices legislation, 457, 493
- Reich, Francis W., 183
- Reinhart, Frank W., 319n
- Remington Rand, 146
- Reorganization Plan No. 2 of 1965, 493
- Reorganization Plan No. 5 of 1950, 151
- Republican Eisenhower-Nixon ticket, 112
- Research Associates, 33
- Research Information Center and Advisory Service  
     on Information Processing, 436
- Research Materials (RMs), 552

resistor noise voltage, 541  
 reverberation measurement, 229  
 Reynolds, Charles A., 46, 47  
 Rheology Section, Heat Division, 204, 390  
 Rheology Section, Mechanics Division, 318  
 Ribicoff, Abraham, 458  
 Rice, F.O., 107n  
 Rigby, F.D., 311n  
 Ring, John, 567  
 Ritchie, Jess M.  
   AD-X2 Hearings, 87n, 88–89, 99, 121–123  
   correspondence with W.J. Hamer, 100  
   criticism of Bureau tests, 107  
   FTC complaint against, 129  
   letter from A.V. Astin, 106  
   letter from J.A. Harris, 90  
   letter to W. Knowland, 90–91  
   POD mail fraud, 103, 110–111, 113  
   political ambitions, 134  
   political pressure by, 101, 104, 112  
   president of Pioneers, Inc., 88  
   suit against government, 129  
 Ritter, Johann W., 544  
 Rivers, Ralph J., 383  
 RNA discoveries, 296, 464  
 Roberts, Benjamin W., 554  
 Roberts, Martin A., 49n  
 Robertson, Alexander F., 452, 595, 597  
 Robinson, Lloyd, 525n  
 rocket propulsion systems, 446  
 Rockett, John A., 507, 595  
 Romanoff, Melvin, 240  
*Roof Maintenance Manual*, 258  
 roofing conditions in military stations, 258  
 Rooney, John, 177–178, 335, 336, 505  
 Roosevelt, Franklin D., 7–8, 157  
 Rosa, Edward B., 197n, 198, 279  
 Rosenthal, Benjamin, 458  
 Ross, Gaylon S., 221  
 Rosser, J. Barkley, 131n  
 Rossini, Frederick D., 421n  
 Rostow, Walter W., 455  
 Roy, Rustom, 8n  
 rubber research, 232–234  
 Rubber Section, 232, 319n  
 Ruff, Arthur W., Jr., 430n  
 Rural Electrification Agency, 194  
 Ruth, Ralph P., 280  
 Ryan, James V., 452, 505–506  
 Rydberg constant, 403

## S

Safety Award, 316  
 Salam, Abdus, 464  
 Salk, Jonas, 147  
 Saltonstall, Leverett, 163  
 Samuel Wesley Stratton Award, 313–315  
 Samuelson, Robert J., 137  
 San Fernando earthquake investigation, 593, 594  
   595  
 Sandy Bagg, anthropomorphic dummy, 498  
 sapphire, fracture mechanics studies, 575  
 satellites  
   CRPL program, 443–445  
   in geosynchronous orbit, 532  
   in golden age of science, 295  
   IGY effort and, 288, 439, 443  
   orbit theory, 430  
   *See also names of specific satellites*  
 Sawyer, Charles W., 105, 151, 165, 171, 184  
 scaling laws, 571, 572  
 scanning photoelectric spectrometer, automatic,  
   220  
 scattering studies, 408–409, 534, 563–565  
 Schafer, George E., 318  
 Schaffer, Robert, 552  
 Schedule A positions, 188–189  
 Scheer, Milton D., 402n  
 Scheiber, Donald J., 393  
 Scheick, William H., 336  
 Schine, G. David, 140  
 Schon, Donald A., 343, 468  
 Schooley, James F., 561  
 Schoonover, Irl C., 341  
   Analytical and Inorganic Chemistry Division,  
   318  
   appointment as Bureau deputy director, 468  
   as chief of Material Products Division, 246  
   crystal research, 582  
   establishment of the Samuel Wesley Stratton  
   Award, 313–314  
   Institute for Materials Research (IMR), 342  
   interview, 65  
   memorandum to A.V. Astin  
   NBS Reactor, 413  
   NIPS proposal, 340  
   retirement, 470, 519  
   study of NBS programs, 301n  
 Schreyer, Milton F., 78  
 Schrieffer, John R., 148  
 Schubauer, Galen B., 311n

- Schwinger, Julian, 11
- science
- effect of atomic bomb on, 6
  - effect of decrease in Federal Government R&D expenditures, 460-464
  - golden age of, 294-297
  - growth of, 143-148, 464-465
  - political impact of, 135
- scientists, education of, 145
- SCOOP (Scientific Computation of Optimum Programs), 265, 267
- Scott, Arnold H., 393n
- Scott, Russell B.
- as chief of Cryogenic Engineering Division, 187, 321
  - design of cryogenic facility, 185, 186
  - manager of Boulder Laboratories, 322, 343
  - superconductivity research, 46
- Scribner, Bourdon F., 110n, 130n
- Scribner, Bourdon W., 49
- Seaborg, Glenn T., 157n
- SEAC (Standards Eastern Automatic Computer)
- aircraft engineering calculations, 227
  - in applied mathematics, 263, 265, 266, 267
  - design and construction, 11, 42-44, 433
  - in electron physics, 218
  - ray tracing in lens designs, 194
- seat belt standard, 495-496
- Seaton, Michael, 324
- second, definition of the, 372-374
- Second International Congress of Radiology, 58, 59
- Second Kelly Committee Report, 304-310, 438.
- See also* Kelly Committee Report
- second sound in helium, 206
- Seeger, R.J., 311n
- segregation, 291-293
- Seigwarth, J.D., 541n
- Selby, Myron C., 543
- Selective Service System (SSS), 565-567
- self-ignition of fibrous materials, 259
- semiconductors, 214, 437-438, 450, 560-563, 586-589
- Senate Committee on Government Operations, 339n
- Senate Foreign Relations Committee, 139
- Senate Interstate Commerce Committee, 182
- Senate Select Committee on Atomic Energy, 160
- Senate Select Committee on Small Business (SSCSB), 104-105, 108, 121-127
- Sengers, Jan V., 572
- Sengers, Johanna M.H. Levelt, 572
- Senior Lunch Club, 69
- sensor materials, cryogenic, 446
- Serber, Robert, 157
- Serin, Bernard, 46, 47
- Servicemen's Readjustment Act of 1944, 2n
- Shannon, Claude, 11
- Shannon, James A., 471
- Shapely, Deborah, 8n
- Shapley, Alan H., 440
- Shapley, Harlow, 158
- Sheaffer, Craig R., 112-115, 130, 134
- Shelter Island conference, 10-11
- Sher, Alvin H., 589
- Sherley Amendment, 457
- Shields, William R., 581n
- ship failures, 242-246
- ship plate, interrupted longitudinal specimen, 244, 245
- Shockley, William, 11, 468
- shock waves, analysis of solar noise, 275
- Shuler, Kurt E., 313
- SI (*Le Système International d'Unités*), 386-387, 511
- Sidey, Hugh, 289
- Siegwarth, James D., 541n
- silica, 252
- silicon resistivity, measurement, 586-588
- Silsbee, Francis B., 45-46, 193, 301, 317
- Silver, A.H., 541n
- Silver Bridge, 576-579
- Silver Medal, award, 313
- Simon, Sir Francis E., 208
- Simplified Commercial Practices Division, 253n
- Simpson, John A., 217, 407, 408-409
- simultaneous linear equations, 263
- Sinclair, Upton, 457
- Sirhan Sirhan, 456
- Sitterly, Charlotte E. Moore, 324, 554
- Skramstad, Harold K., 18
- sky waves, 375
- Slutz, Ralph J., 43, 44n, 188, 318
- Small, James, G., 528
- Smathers, George A., 126
- Smith, Ernest K., Jr., 318, 322
- Smith, Leslie E., 53n
- Smith, Neil, 458
- Smith, Newbern, 183, 272
- Smith, Ralph W., 20n
- Smith, Stephen J., 323n
- Smithers, V.L., 95n
- smog components, identification, 220
- smoke density measurement, 597-598
- Smyth, Henry D., report, 5
- Snider, Charles S., 371
- Snyder, Clarence L., 110n, 130n
- Social Security Amendments of 1965, 456

- Society of Automotive Engineers, 495, 512
- soda-lime-silica glass standard sample, **550**
- software standards, Center for Computer Sciences and Technology, 559
- solar flares, 275, 276
- solid-state electronics, 43
- Solid State Physics Section, 238, 560
- Solution Chemistry Section, 419
- Sommer, Helmut, 55
- Sony, 146, 295
- Sorrows, Howard E., 468, 470
- Sotirov, Dimitrov, 165
- Soulen, Robert, 541
- sound and vibrations, 228–229
- sounding stations, 442–443
- sound level, measuring, 228
- sound propagation studies, **230**
- Sound Section, 226n, 493
- South Korea, 6, 137–139
- Southern Christian Leadership Conference (SCLC), 291, 292
- Soviet Union, WW II alliance with, 3
- space probes, 464
- space race, 143, 289, 295
- Space Science Board, National Academy of Sciences, 323
- Spadin, Paul, 525n
- Sparkman, John, 116, 126
- Sparks, Morgan, 468
- special central responsibilities, 310, 311
  - Clearinghouse for Federal and Scientific Information, 514, 518
  - fire research program, 507
  - Central Radio Propagation Laboratory, 493
  - Office of Invention and Innovation, 518
- Special Foreign Currency Program, PL-480 money, 303
- Special Publication 300, *Precision Measurement and Calibration*, 32
- Special Study of NBS Programs Supported by Other Federal Agencies, 301
- Special World Intervals, 440
- spectral radiance and irradiance standards, 547
- Spectrochemistry Section, 419
- spectrographic analysis, 219
- spectrometers
  - automatic scanning photoelectric, 220
  - electron scattering, 564
  - mass, 580, **581**
  - triple-axis, 568
  - x-ray, 429
- spectrometric analysis of high-purity gases, 220
- spectroscopy, 37–40, 213–214, 403–404, 405–408
- Spectroscopy Section, Atomic Physics Division, 213
  - speed of light, measurements, 54, 278–281
  - Spencer, Lewis V., 412n
  - sperm candle, 546
  - spontaneous ignition of fibrous materials, 259–260
  - sputniks, 143, **144**, 146, 288
  - stacking fault studies, 430
  - Staggers, Harley, 458
  - Stalin, Joseph, 141
  - Standard Colors for Kitchen and Bathroom Accessories, 32
  - standard kilogram, 19–20, **21**, 226, 229
  - standard reference data, 252, 553–554
  - Standard Reference Data Act, 332, 466, 493
  - Standard Reference Materials (SRMs), 379–380, 425–426, 450, 550–552, 582. *See also* standard samples
  - Standard Reference Materials Section, 419
  - standard samples, 31–32, 34, 35, 380
    - Atomic and Radiation Physics Division, 215, **216**
    - Chemistry Division, 218, 219, 220, **223**
    - See also* Standard Reference Materials (SRMs)
  - standard x-ray patterns, 252
  - standardizing laboratories, 284–285
  - standards
    - anthropomorphic dummy, 498–500
    - blackbody, platinum, 387–388, **389**
    - calibrations, 31–32, 377–379
    - candle, 546
    - commodity, 381–382, 521
    - comparison of, 30–31
    - customary standards, **555**
    - customary units, 20
    - electrical, 20–21, 22–23, 390–391
    - Federal Information Processing Standards (FIPS), 556–560
    - fundamental constants, 54–55, 278–281
    - high pressures, 355–362
    - kilogram, 19–20, **21**, 226, 229
    - large forces, 362–367
    - length, 194, 345–353, 522–524
    - mass, 533–537
    - mechanical, 226
    - national, 19–20, 21
    - photometric, 194, 387–388
    - provision and verification of, 21–23
    - radioactivity, 32, 411–412
    - radio frequency, 272, 374–377, 395–397, 542–544
    - radiometry, 544–549



- standards (*continued*)
- radium, 215
  - SI units, 386-387, 511
  - spectral radiance, 547
  - Standard Reference Data, 553-554
  - Standard Reference Materials, 550-552
  - for the states, 555-558
  - temperature measurements for, 203-204, 353-355, 541-542
  - time and frequency, 367-377
  - Treaty of the Meter, 19
  - tungsten-filament lamps, 547
  - voluntary, 28
  - weights and measures, 31, 32, 382-386
  - x ray, 215
  - See also* calibrations; measurements
  - Standards Eastern Automatic Computer (SEAC)
    - See* SEAC (Standards Eastern Automatic Computer)
  - standards laboratories, private, 285
  - Standards Western Automatic Computer (SWAC)
    - See* SWAC (Standards Western Automatic Computer)
  - Stanford Linear Accelerator Center, 464
  - Stans, Maurice, 521
  - Stansbury, Carroll C., 301n
  - Stark shifts, 397, 527
  - STATAC-SCOOP computer, 267
  - State of Maryland, weights and measures, 556-557
  - state weights and measures, 31, 32, 55, 555-558
  - statistical control, 534
  - statistical design of experiments, 265-266
  - Statistical Engineering Laboratory, 261, 265
  - Statistical Physics Section, 569-572
  - statistical thermodynamics, 398
  - Statutory Advisory Committee, 308
  - steady-state propagation, 276
  - steel, fracture behavior, 238, 240-246
  - Steel, Kurt, 77
  - Stefan-Boltzmann constant, 546, 548
  - Stegun, Irene A., 264n
  - Steiner, Bruce W., 388
  - Stern, Robert L., 337n, 340
  - Stiehler, Robert D., 319n
  - Stone, William J., 48
  - Stratton, Julius, 105, 109
  - Stratton, Samuel Wesley, 19, 20
  - Stratton Award, 313-315
  - Strauss, Lewis L., 383
  - stress-corrosion cracking, 240
  - stress intensity factor, 575
  - Strine, G.L., 396
  - Stromberg, Robert R., 426n
  - strontium titanate, 561-563
  - structural behavior during natural disasters, 592-595
  - structural endurance in fires, 452
  - Structural Engineering Section, 254
  - Stryker, Frances, 442
    - Study Paper on Major Needs of the National Bureau of Standards, 305-306
  - subnuclear particles, classifying, 296
  - sugars with radioactive C<sup>14</sup>, 222-224
  - Suits, C. Guy, 131n, 304n
  - sulfation process, 85
  - Sullivan, Donald B., 542
  - Sullivan, Leonor, 458
  - Sullivan, Walter, 439n
  - Summerfield, Arthur, 113
  - sundial, 485
  - sunspot cycle, 274, 439
  - Super (bomb), 185
  - superalloys, 219
  - superconducting junctions, 539
  - superconducting semiconductors, 560-563
  - Superconductive Materials Data Center, 554
  - superconductivity, 44-47, 148
  - superconductors, type II, 446, 563
  - supersonic wind tunnel, 227
  - SURF I (Synchrotron Ultra-Violet Radiation Facility), 406
  - SURF II, 408
  - Surface Chemistry Section, 421n
  - SWAC (Standards Western Automatic Computer), 43, 263, 267, 433
  - Sweeney, William T., 319n
  - synchrotron, 61, 547
  - synchrotron light, 405-408
  - synthesis of sugars with radioactive C<sup>14</sup>, 222-224
  - synthetic fibers, 11
  - synthetic polymers, 232, 424-425
  - synthetic rubber, 222, 232-234
  - Système International d'Unités* (SI), 386-387, 511
  - systems analysis, 507-509, 510
  - Systems Research Laboratory, 67, 272

## T

- Tables of Random Permutations*, 566
- TACAN air navigation system, 276
- Tate, Douglas R., 365n
- Tatlow, Richard H. (III), 336
- Taylor, Barry N., 373n, 386n, 539

- Taylor, Lauriston S.  
 as chief of Atomic and Radiation Physics  
 Division, 213  
 on Edward U. Condon, 168  
 memorandum from R.S. Caswell, 414  
 Radiation Physics Division, 318  
 security issues, 166  
 x-rays, 57, 58–59, **60**  
 World War II, 59
- Teal, Gordon K., 468
- technetium, 214
- Technical Analysis Division (TAD), 507–510
- Technical Documentation Center, 513
- techniques network, National Measurement  
 System, 511
- television signals for time dissemination, 533
- Telstar* satellite, 295
- Temmer, Georges M., 208
- temperature measurements  
 in fire research, 596  
 International Practical Temperature Scale,  
 45n, 203–204, 541  
 for standards, 353–355, 536, 541
- Temperature Section, 541
- temperature scales, 44–45
- tensile bond specimen, **255**
- tensile test, ship plate, **244**
- Terman, Fred E., 132n
- terrestrial noise studies, 273–275
- Terrien, Jean C., 541
- test wall, **491**
- testing  
 examples, 34–35  
 products, 27  
 Building Technology Division, 257–259  
 end of testing, 380–381  
 Kelly Committee Report, 282–284  
 Mechanics Division, 226  
 Mineral Products Division, 246–247  
 policy on tests for private individuals, 75  
 standardizing laboratories, 284–285  
 and publications, 71–74  
 for regulatory agencies, 71, **73**, 282  
*See also* Aquella; Battery AD-X2
- Testing and Specifications Section, 232
- Textile and Apparel Technology Center, 337, 344
- Textiles Section, 232, 319n
- theoretical particle physics, 464
- theoretical studies, 306, 411
- thermal conductivity, 220, 450, 554
- thermal insulating capacity of building structures,  
 257
- Thermal Metallurgy Section, 238, 428
- thermal properties of matter, 204
- thermochemistry, 218, 221–222
- Thermochemistry Section, 421n
- thermocouples, 389, 446, 545
- thermodynamic data on organic compounds, 554
- thermodynamic properties research, 398–399
- thermodynamic studies on polymers, 233
- thermodynamics, 204–205, 398
- thermometers, 35, 44
- thermometry, 22
- Thermopane windows, 51
- Thomas, Albert, 477
- Thomas, Elbert, 163
- Thomas, Harold A., 55, 392
- Thomas, J. Parnell, 13, 159, **164**, **169**
- Thomas, James L., 32
- Thomas, Richard N., 324, 328
- Thompson, A.M., 390
- Thompson, John G., 238
- Thornton, Dan, **189**
- Thye, Edward, J., 113, 119, 121, 124–125
- tides, 228, 273
- Tilley, W. Reeves, 421n
- time and frequency, 367–377
- time dissemination, 374, 529–533
- tire grading system, 497–498
- tires, road tests, 35
- titanates, 219
- titanium studies, 238
- Titan missile, 288
- Tomarkin, Leandro W., 74–77, 79
- Tomonaga, Sin-Itiro, 11
- tooth material, 236–237
- topside-sounding, 443–445
- tornado investigation, Lubbock, Texas, 593
- Touloukian, Y.S., 554
- Townes, Charles H., 147, 280, 296, 368n
- trailer trucks, refrigerated, 256
- training, state weights and measures, 384
- trajectory of missiles, calculation, 264
- transducers, pressure and displacement, 436
- transfer standard, 536
- transferred funds, 15n, 30, 179–180, 300–302
- transient propagation, 276
- transistor technology, 11
- Transport Systems Division, 344
- transportation study, Northeast Corridor, 508
- trap-door codes, 263
- Treaty of the Meter, 19
- triple-axis spectrometer, 568
- tritium, 185
- tropospheric propagation, 188, 276
- Tropospheric Propagation Research Section, 272
- Trowbridge, Alexander B., **469**, 497, 519

Truman, Harry S.

- appointment of A.V. Astin, 171
  - atomic bomb announcement, 5
  - Atomic Energy Commission direction, 6
  - defending South Korea, 138
  - dispersal order, 182
  - Executive Order 9835, 13
  - formation of Interdepartmental Committee on Scientific Research and Development, 145
  - formation of National Science Foundation, 8-9
  - memorandum from E.U. Condon, 167
  - military aid to Greece, 4
  - Publication Board, 513
  - Truman Doctrine, 4
- Tugwell, Rexford G., 457
- tungsten-filament lamps, 205, 547
- turbulence, 226
- Tydings, Millard, 139
- type II superconductors, 446, 563

U

- U-2 reconnaissance aircraft, 146
- U-2 spy plane incident, 287, 289
- UHF range, 272-273
- Uhlenbeck, George E., 572
- underground corrosion, 28, 239-240, 241
- underground shelter, heat transfer experiments, 256
- United States Air Force, communication system, 273
- United States Air Force Cambridge Laboratories, 586
- United States National Committee, 440
- UNIVAC (Universal Automatic Computer), 41-42, 146
- Universal Time (UT), 373
- University of California, Radiation Laboratory, 187, 447
- University of Colorado, Boulder, 326-328
- University of Illinois, Betatron technology, 56
- University of Maryland, 565
- University of Massachusetts, 565
- Upper Air Research Section, 272
- Upper Atmosphere and Space Physics Division, 318
- Urey, Harold, 158
- Uriano Award, 316
- USA Standard Code for Information Interchange (USASCII), 559-560

V

- Vaccine for polio, 147
- Vail, Richard B., 166
- Van Allen, James A., 439
- Van Arend, Peter C., 186
- Van Ness Street, N.W., 63, 64
- Van Valkenburg, Alvin, 253, 357-360
- Van Vleck, J.H., 119n
- Van Zandt, Thomas E., 444
- Vander Sluis, Kenneth L., 280
- vapor lock, 446
- Velde, Harold H., 166
- ventilation parameter, 597
- very-high-field magnets, 448-449
- Veteran's Administration, 195, 196, 259
- VHF range, 272-273
- VHF signals, 443
- vibration generator, 195
- vibration pickups, calibration of, 228
- Vicentini-Missoni, Matilde, 572
- Vietnam War, 291, 453-456, 461, 462
- Vigoreux, Paul, 386
- Vinal, George W.
  - Battery AD-X2 test report, 95
  - chief of the Electrochemistry Section, 81
  - correspondence with J.A. Harris, 90
  - correspondence with K.B. Willson, 92, 93, 94, 96-98,
  - correspondence with M. Randall, 87, 89
  - Letter Circular 302, revision, 93
  - Letter Circular 504, *Battery Additives*, 97
  - memorandum to E.U. Condon, 93
  - Storage Batteries*, 81
- Vinogradoff, Dmitri I., 162
- Virginia Polytechnic Institute, 565
- viscoelastic substances, 390
- viscosity-measuring instruments, 204, 550
- Visiting Committee, 113, 119-120, 130, 149
- volt maintenance, 537-540
- voltmeters, calibrating, 23
- Volumetry and Densimetry Section, 318
- Voorhees, Walker, Smith, and Smith,
  - architectural firm, 480, 481, 482
- Voting Rights Act of 1965, 456

W

- Waals, Johannes van der, 570
- Wachtman, John B., Jr., 360, 423-424, 584
- wafer pattern printer, 201

- Wagman, Donald D., 421n, 554  
Wagman, Frederick H., 53n  
Waidner, Charles W., 389  
Wait, James R., 313, 314  
Walker, Eric A., 6n  
Wall, Leo A., 319n, 478n  
wall, test, 491  
Wallace, George, 456  
Wallace, Henry A., 78, 149, 151, 152  
Walleigh, Robert S., 479  
    associate director for administration, 470  
    director of administration, 343, 598  
    Gaithersburg facilities, 476n, 477, 478, 481  
Wallenstein, Merrill B., 318, 329, 331, 421, 473  
Walsh, John, 146  
Walsh, Philip J., 434  
Wampler, E. Joseph, 525n  
Ware, Charles, 414  
war-games model, theoretical analysis of, 264  
wartime appropriations, 30  
wartime development of synthetic rubber, 232n  
Washburn, Edward W., 329  
Waterman, Alan T., 9, 10  
Water Pollution Control Act, 293  
waterproofing paint, 71, 74-79  
water-vapor permeability of materials, 234, 258-259  
Watson, James D., 11, 296  
wavelengths, 194, 214, 349-351, 522-524  
waves, magnitude of, 228  
Weather Bureau, 267, 304n, 433, 492, 508, 509  
weather stations, 436, 437  
Weber, Harold C., 104, 108, 111, 126-127  
Weeks, James J., 393  
Weeks, Sinclair  
    Battery AD-X2  
        A.V. Astin dismissal, 114  
        A.V. Astin reinstatement, 129-130  
        A.V. Astin requests, 113  
        Kelly Committee Report, 130  
        letter from D.W. Bronk, 120  
        objectivity, 117  
        testimony, AD-X2 Hearings, 112, 115  
    dedication of NBS Boulder Laboratories, 189  
    Gaithersburg facilities, 477  
    NBS Open House, 154  
    as secretary of commerce, 112  
    study of science and technology in Dept. of Commerce, 304  
weights and measures  
    National Conference on, 32  
    standards, 385-387  
    for states, 31, 32, 382-385, 555-558  
Weinberg, Steven, 464  
Weinrich, Marcel, 212n  
Weir, Charles E., 253, 357-360  
Weisner, Jerome, 333  
Weiss, Pierre, 570  
Welch, Joseph, 140-141  
Welch, S.W.J., 183  
welded ships, failure of, 242-246  
Wells, Joseph S., 281n, 528n, 529n  
Wentzel, Gregor, 409  
Western Hemisphere Radio Warning Service, 443  
Westfall, F. Oliver, 38  
Westrate, J., 311  
wet bomb, 186  
Wheatly, George M., 260  
Whiddington, R., 407  
White, Robert M., 492  
White House Panel on Civilian Technology, 333-334, 336  
white iron, 219  
Whitlock, Douglas, 336  
Wholesome Meat Act, 459  
Wholesome Poultry Products Act, 459  
Wichers, Edward, 218  
Wieber, Donald, 525n  
Wiederhorn, Sheldon M., 573-575  
Wiens, Jacob H., 38  
Wiese, Wolfgang L., 404n  
Wildhack, William A., 192, 382  
Wilkins, Maurice, 296  
Wilkes, Samuel S., 132n  
Wilkinson, D.T., 525n, 526n  
William P. Slichter Award, 316  
Williams, Clyde, 131n  
Williams, Evan J., 570  
Williams, Morgan L., 242n, 244n  
Williams, Walter, 178, 305  
Willson, Kenneth B.  
    correspondence with G.W. Vinal, 92, 94, 96-98  
    letter from E.U. Condon, 93, 98  
    letter from J.A. Harris, 95  
    letter to P.L. Howard, 99  
Willys Motor Co., 203  
Wilson, Bruce L., 318, 366n  
Wilson, Charles E. ("Engine Charlie"), 112, 262, 381  
Wilson, Kenneth, 572  
Wilson, Robert W., 464  
Wilson, William E., 554  
Wilson, Woodrow, 30  
wind tunnel, supersonic, 227  
Winer, Irvin, 525n

Wolkinson, Herman, 114n  
Wolman, Abel, 131n, 304n  
Wood, Lawrence A., 319n  
Working Capital Fund, 178n, 180  
Working Fund Work Policy Statement, 301n  
Worksman, Thelma, 236  
World Data Center A for Airglow and Ionosphere,  
441, 442  
World Warning Agency, 440, 441  
World-Wide Seismology Net, 508  
Worthy, James C., 114n, 130, 475  
Wright, J. Howard, 270  
Wright, James R., 450n, 590  
Wright, Wilbur H., 46  
Wright Air Development Command,  
polycrystalline ceramics, 251-252  
Wu, Chien-Shiung, 147, 208-209, 212  
WWV radio station, 14, 17, 272  
field station, 274,  
frequency dissemination, 374-375  
time dissemination, 529, 530, 531, 533  
WWVB radio station, 375, 376-377, 529  
WWVH radio station, 14-15, 272, 274, 375,  
531-532  
WWVL radio station, 376-377, 529

## X

Xerox Corporation, 295  
x-ray diffraction  
dental research, 236-237  
determination of crystal structure, 252  
powder patterns, 359  
for research on microstructure and  
piezoelectric properties, 250-251  
structure of myoglobin and hemoglobin, 296  
x-ray spectrometer, 429  
x rays  
high-energy measurements, 21, 56-62,  
214-215  
medical use, 57, 59  
nuclear studies, 59  
protection from, 214-215  
standards, 21, 59, 215  
X-Rays Section, 213

## Y

Yalta agreement, 3  
Yang, Chen Ning, 147, 207-208, 212, 572  
yard, refining values for, 385-386  
Yates, Sidney R., 300, 353, 416

Yost, Charles F., 582  
Young, Theodore R., 346n, 347, 426

## Z

Zalubas, Romuald, 403n  
Zapas, Louis J., 390n  
Zeeman shifts, 527  
Zeiger, Herbert J., 147, 296  
Zernike, Frits, 571  
zeroth postdoc, 190  
Ziegler, Guy C., 434  
Ziegler, Karl, 147  
Zimmerman, J.E., 541n  
zinc oxide, 237  
Zwanzig, Robert W., 421n  
Zwolinski, Bruno J., 554