

Relative Humidity-Temperature Relationships of Some Saturated Salt Solutions in the Temperature Range 0° to 50° C¹

Arnold Wexler and Saburo Hasegawa

The relative humidity-temperature relationships have been determined in air in equilibrium with saturated salt solutions of lithium chloride, $\text{LiCl}\cdot\text{H}_2\text{O}$; magnesium chloride, $\text{MgCl}_2\cdot 6\text{H}_2\text{O}$; sodium dichromate, $\text{Na}_2\text{Cr}_2\text{O}_7\cdot 2\text{H}_2\text{O}$; magnesium nitrate, $\text{Mg}(\text{NO}_3)_2\cdot 6\text{H}_2\text{O}$; sodium chloride, NaCl ; ammonium sulfate, $(\text{NH}_4)_2\text{SO}_4$; potassium nitrate, KNO_3 ; and potassium sulfate, K_2SO_4 , over a temperature range of 0° to 50° C, using the dewpoint method. The relative humidity is a continuous function of temperature, and, except for sodium chloride, is monotonic. The curve for sodium chloride increases from 74.9-percent relative humidity at 0° C to a maximum of 75.6 percent at 30° C and then gradually decreases to 74.7 percent. The maximum change in relative humidity with temperature, about 15-percent relative humidity as the temperature increases from 0° to 50° C, occurs with saturated salt solutions of sodium dichromate and magnesium nitrate.

1. Introduction

Saturated salt solutions are very useful in producing known relative humidities, principally for testing and calibrating selected hygrometers and hygrographs at temperatures above 0° C. The saturated salt solution is made up as a slushy mixture with distilled water and chemically pure salt in a glass or enameled tray and is enclosed in a sealed metal or glass chamber. When equilibrium conditions, usually hastened by forced air circulation or stirring, are attained, the chamber space is at a constant relative humidity. Some saturated salt solutions produce relative humidities that are roughly independent of temperature.

The equilibrium values of relative humidity of the saturated solutions of several salts used in calibration and testing are listed in NBS Circular 512 [1]² and are based partly on vapor-pressure data given in the International Critical Tables [2] and partly on dewpoint measurements made at NBS. The relative humidity-temperature relationships of these, as well as several other, saturated salt solutions have been redetermined and are the subject of this paper.

The measurement of vapor pressure or vapor pressure lowering of a salt solution may be made in several ways. The differential methods are based on the determination of the difference in vapor pressure between the solution and solvent, using a sensitive differential manometer. In the dynamic method, the boiling point of the solution is determined under reduced pressure. The transpiration, or gas-saturation, method involves the gravimetric measurement of the water-vapor content of an inert gas saturated by passage over or through the salt solution. The dewpoint method consists in reducing the temperature of a mirror surface until condensation occurs.

The dewpoint method was utilized in this investigation. With this method, measurements could readily be made in the presence of an air atmosphere under conditions similar to those occurring in the use of saturated salt solutions for humidity-control purposes. Furthermore, other than using chemically pure salts of reagent grade and distilled water, no special precautions were taken. Thus the salts contained trace impurities, and the water was air saturated.

2. Description of Apparatus

The experimental setup shown in figure 1 was used to determine the equilibrium vapor pressure of a saturated salt solution. The bottom of a 2-liter Wolff flask, A, was filled to a depth of 2 inches with a saturated solution of a salt, B, made up as a slushy mixture with a pure reagent grade chemical and distilled water. A dewpoint apparatus, C, was inserted through one side neck of the flask; an air stirrer, D, was inserted through the central neck of the flask; and two copper-constantan thermocouples, E and F, were inserted through the other side neck of the flask. The Wolff flask was immersed in a liquid bath, O. Automatic temperature control of the bath was achieved by a system in which thermistors, in a bridge circuit, detected the temperature unbalance and a heater, H, supplied heat in proportion to the unbalance. Below room temperature, a cooling system, I, was used to reduce the bath temperature.

The shaft of the air stirrer, D, was supported in a close-fitted bearing and driven, through a belt and pulley, by an external remotely positioned motor.

Thermocouple, E, measured the air temperature within the Wolff flask, thermocouple, F, measured the temperature of the saturated salt solution, and thermocouple, H, measured the temperature of the liquid bath. These thermocouples were made with cotton-covered Bakelite-insulated wire. To insure that no spurious electromotive force would be

¹ This investigation was financially supported by the Aerology Branch, Bureau of Aeronautics, Department of the Navy.

² Figures in brackets indicate the literature references at the end of this paper.

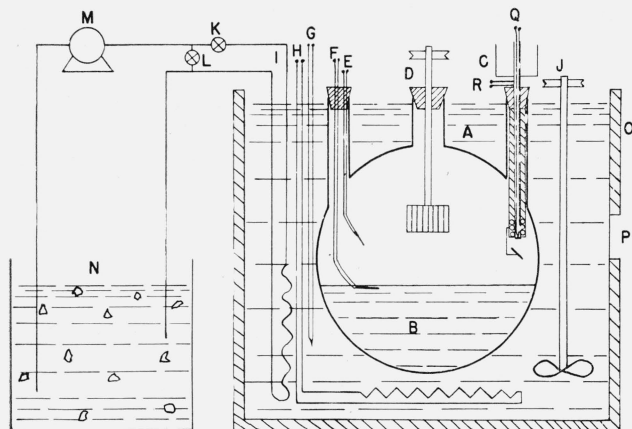

FIGURE 1. *Experimental setup.*

A, 2-liter Wolf flask; B, saturated salt solution; C, dewpoint apparatus; D, air stirrer; E, thermocouple for measuring air temperature; F, thermocouple for measuring temperature of saturated salt solution; G, thermocouple for measuring bath temperature; H, bath heater; I, cooling system; J, liquid bath stirrer; K, cooling system control valve; L, cooling system by-pass valve; M, cooling system pump; N, Stoddard's solvent mixed with dry ice; O, liquid thermostated bath; P, position external to bath from which a light is projected on the dewpoint mirror and from which the dewpoint mirror is observed with a telescope.

introduced because of electrolytic action, each junction was coated and protected with polystyrene cement. The thermocouple leads were covered with grounded equipotential shields. A precision potentiometer was used to measure the thermocouple electromotive force with a precision of better than 1 microvolt.

A light was projected on the dewpoint mirror and the mirror was viewed, through a telescope, from position, P, external to the liquid bath.

Details of the dewpoint apparatus are shown in figure 2. A brass cup, A, 3 inches in diameter and 3 inches deep, was attached to one end of a $\frac{1}{4}$ -inch-outside-diameter copper tube, B, $\frac{1}{32}$ -inch in wall thickness. A dewpoint mirror, H, was soldered to the other end of the copper tube. This mirror, $\frac{1}{4}$ -inch-outside-diameter and $\frac{1}{8}$ inch thick, was machined from copper, with a recess equal to the wall thickness of the copper tube so that it would fit snugly in the end of the tube. The reflective surface of the mirror was first ground and polished, then plated with chromium, and finally lapped to within one-half fringe of optical flatness. A 1-mm-diameter hole was drilled in the center of the mirror, from the rear, to within about $\frac{1}{64}$ inch of the front reflective surface. A copper-constantan thermocouple, C, B&S gage No. 30, was inserted into the hole and soldered to the mirror.

An insulated-wire heater, E, was wound around the copper tube close to the mirror end. This heater was controlled by a variable transformer from a 60-cycle a-c power source. Glass-wool insulation, G, was wrapped around the copper tube and retained in position by a Bakelite tube, F, $\frac{3}{4}$ -inch outside diameter. A galvanometer mirror, I, attached to the Bakelite tube by a metal bracket, J, allowed convenient viewing of the dewpoint mirror.

The addition of dry ice and alcohol to the brass cup, A, figure 2, served as a cold source for cooling

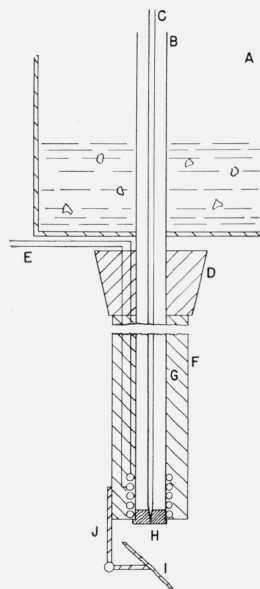

FIGURE 2. *Dewpoint apparatus.*

A, Brass cup; B, copper cooling tube; C, thermocouple; D, rubber stopper; E, heater; F, Bakelite tube; G, glass wool insulation; H, dewpoint mirror; I, viewing mirror; J, support bracket.

the dewpoint mirror, H, through conduction along the copper tube, B. By decreasing the voltage applied to heater, E, the temperature of the dewpoint mirror could be lowered gradually until dew or frost was detected. By increasing the voltage applied to heater, E, the temperature of the mirror could be raised slowly until all dew or frost disappeared. The dewpoint mirror temperature corresponding to the instant of appearance and disappearance was measured by thermocouple, C.

3. Experimental Procedure

The procedure employed in making observations was to adjust the liquid-bath temperature to some desired value and then permit the Wolf flask, with its contents to come to temperature equilibrium. After equilibrium had been established, an observer would manipulate the dewpoint heater control and simultaneously view the dewpoint mirror until he had obtained five successive appearances and disappearances of dew or frost on the dewpoint mirror. A second observer would then repeat the process under the same operating conditions. Occasionally, the two observers would take repeat sets of observations. In this fashion, for any one salt, data were obtained at 10-deg. intervals from 0° to 50° C.

4. Results

For purposes of this investigation, it was assumed that the dewpoint corresponded to the mean of the observed temperature at which dew first appeared and then disappeared. For a given observer, each dewpoint therefore corresponded, usually, to the average of a minimum of 10 temperature observa-

TABLE 1. Observed temperature-relative humidity data

Lithium chloride LiCl·H ₂ O							
Temperature.....°C--	0.23	9.56	19.22	29.64	39.64	46.76	
Relative humidity....%	14.7	13.4	12.4	11.8	11.8	11.4	
Magnesium chloride MgCl ₂ ·6H ₂ O							
Temperature.....°C--	0.42	9.82	19.53	30.18	39.96	48.09	
Relative humidity....%	35.2	34.1	33.4	33.2	32.7	31.4	
Sodium dichromate Na ₂ Cr ₂ O ₇ ·2H ₂ O							
Temperature.....°C--	0.60	10.14	19.82	30.04	37.36	47.31	
Relative humidity....%	60.4	57.8	55.5	52.4	50.4	48.0	
Magnesium nitrate Mg(NO ₃) ₂ ·6H ₂ O							
Temperature.....°C--	0.39	9.85	19.57	30.47	40.15	48.10	
Relative humidity....%	60.7	57.5	55.8	51.6	49.7	46.2	
Sodium chloride NaCl							
Temperature.....°C--	0.92	10.23	20.25	30.25	39.18	48.30	
Relative humidity....%	75.0	75.3	75.5	75.6	74.6	74.9	
Ammonium sulfate (NH ₄) ₂ SO ₄							
Temperature.....°C--	0.39	10.05	20.04	30.86	39.97	47.96	
Relative humidity....%	83.7	81.8	80.6	80.0	80.1	79.2	
Potassium nitrate KNO ₃							
Temperature.....°C--	0.62	10.17	20.01	30.70	40.35	48.12	
Relative humidity....%	97.0	95.8	93.1	90.6	88.0	85.6	
Potassium sulfate K ₂ SO ₄							
Temperature.....°C--	0.54	10.08	19.81	30.44	39.94	48.06	
Relative humidity....%	99.0	98.0	97.1	96.8	96.1	96.0	

tions. The dewpoint, for a salt at a test temperature, was taken as the mean of the dewpoints obtained by each observer.

The ambient temperature was assumed to be the mean of the air temperature and the salt temperature within the Wolff flask. As these temperatures were relatively stable for appreciable periods of time, only one such set of temperature readings was obtained by each observer for his corresponding set of dewpoint observations.

The relative humidity in equilibrium with the saturated salt solution is given by

$$RH = \frac{e_d}{e_a} \times 100,$$

where e_d is the vapor pressure of pure water at the dewpoint temperature, and e_a is the vapor pressure of pure water at the ambient temperature. The vapor pressures given in the Smithsonian Tables [3] were used in this computation.

The mean relative humidity at each observed test temperature is presented in table 1 for eight different saturated salt solutions ranging in relative humidity from about 11 percent to 99 percent. The data for each salt were plotted, and the best smooth curve obtainable by eye was drawn through the plotted points. The faired values from this smooth curve are given in table 2. They represent the best estimates of the relative humidities obtained with these salts at the selected temperatures.

TABLE 2. Faired values of relative humidity versus temperature

Temperature	Relative humidity of saturated salt solution							
	LiCl·H ₂ O	MgCl ₂ ·6H ₂ O	Na ₂ Cr ₂ O ₇ ·2H ₂ O	Mg(NO ₃) ₂ ·6H ₂ O	NaCl	(NH ₄) ₂ SO ₄	KNO ₃	K ₂ SO ₄
°C	%	%	%	%	%	%	%	%
0	14.7	35.0	60.6	60.6	74.9	83.7	97.6	99.1
5	14.0	34.6	59.3	59.2	75.1	82.6	96.6	98.4
10	13.3	34.2	57.9	57.8	75.2	81.7	95.5	97.9
15	12.8	33.9	56.6	56.3	75.3	81.1	94.4	97.5
20	12.4	33.6	55.2	54.9	75.5	80.6	93.2	97.2
25	12.0	33.2	53.8	53.4	75.8	80.3	92.0	96.9
30	11.8	32.8	52.5	52.0	75.6	80.0	90.7	96.6
35	11.7	32.5	51.2	50.6	75.5	79.8	89.3	96.4
40	11.6	32.1	49.8	49.2	75.4	79.6	87.9	96.2
45	11.5	31.8	48.5	47.7	75.1	79.3	86.5	96.0
50	11.4	31.4	47.1	46.3	74.7	79.1	85.0	95.8

TABLE 3. Scatter of data about smooth curves

Nominal temperature	Relative-humidity deviation of data from curve of saturated salt solution							
	LiCl·H ₂ O	MgCl ₂ ·6H ₂ O	Na ₂ Cr ₂ O ₇ ·2H ₂ O	Mg(NO ₃) ₂ ·6H ₂ O	NaCl	(NH ₄) ₂ SO ₄	KNO ₃	K ₂ SO ₄
°C	%	%	%	%	%	%	%	%
0	0	+0.3	0	+0.2	+0.1	0	-0.5	0
10	0	-3	0	-3	-1	0	+4	+1
20	0	-2	+2	+8	0	0	-2	-1
30	0	+3	-1	-3	0	0	+1	+2
40	+2	+5	-1	+5	-1.0	+4	+1	-1
50	-1	-2	+2	-6	0	0	0	+1
Average..	0	±0.3	±0.1	±0.6	±0.2	±0.1	±0.2	±0.1

The plots of relative humidity versus temperature yield curves that are continuous and, generally, vary little with temperature over the temperature range of 0° to 50° C. These plots are shown as solid-line curves in figures 3 to 10. The maximum variation of relative humidity with temperature occurs with saturated solutions of sodium dichromate and magnesium nitrate. For these salts there is an absolute decrease in relative humidity of about 15 percent as the temperature increases from 0° to 50° C. The scatter of the mean experimental values above the smooth curves is given in table 3. The greatest scatter of the data occurs with sodium chloride and is ± 0.6 percent relative humidity. For the other salts, the scatter is equal to or less than ± 0.3 percent relative humidity.

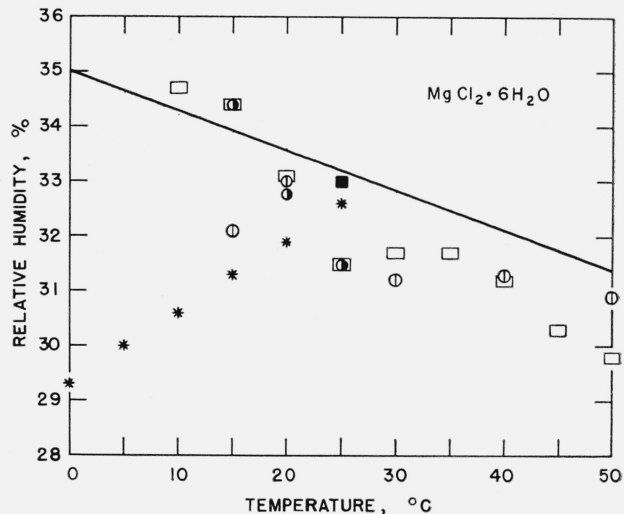

FIGURE 4.
(See fig. 3)

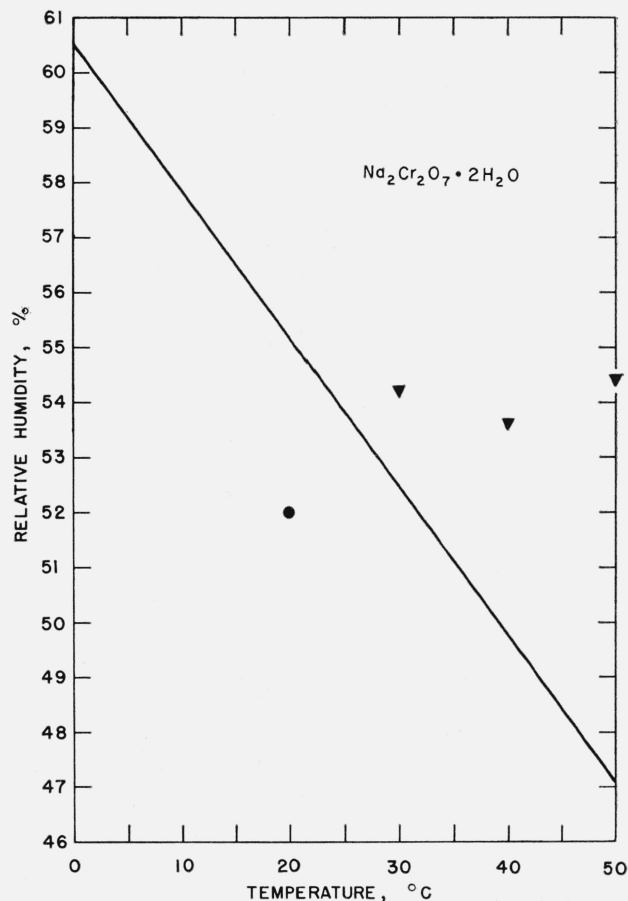

FIGURE 5.
(See fig. 3)

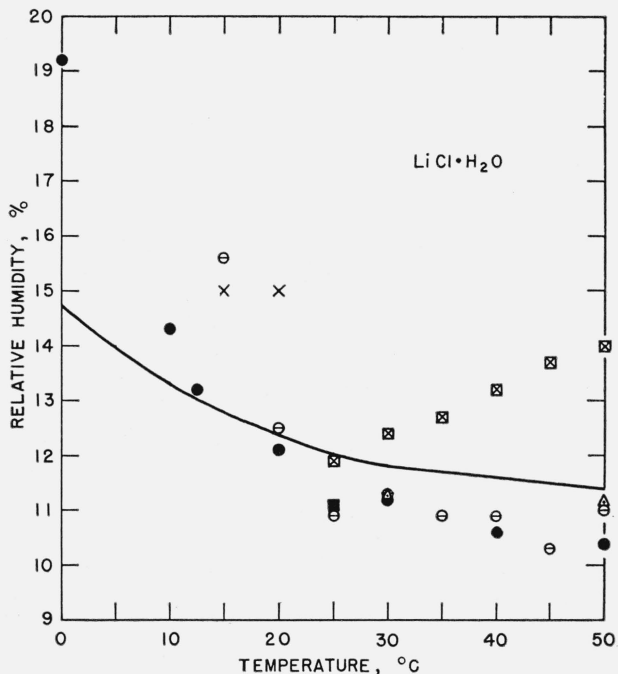

FIGURE 3. Comparison of the faired NBS results with results of other experimenters.

Figures 3 to 10, inclusive, show a comparison of the faired NBS results, as solid-line curves, with the results of other experimenters. The following symbol notation is used throughout these figures:

- ICT [2]
- Foote, Saxton, and Dixon [4]
- + Leopold and Johnston [5]
- △ Sakai [6]
- Adams and Merz [7]
- ◇ Burns [8]
- × O'Brien [9]
- ▲ Speranskii [10, 15]
- ▽ Prideaux [11]
- ◆ Edgar and Swan [12]
- Stokes and Robinson [13]
- * van't Hoff [14]
- ▼ Carr and Harris [16]
- Lescoeur [17]
- Derby and Yngve [18]
- Konduirev and Berezovskii [19]
- Ewing, Klinger, and Brandner [20]
- Johnson and Molstad [21]
- Huttig and Reuscher [22]
- ⊠ Gokcen [23]

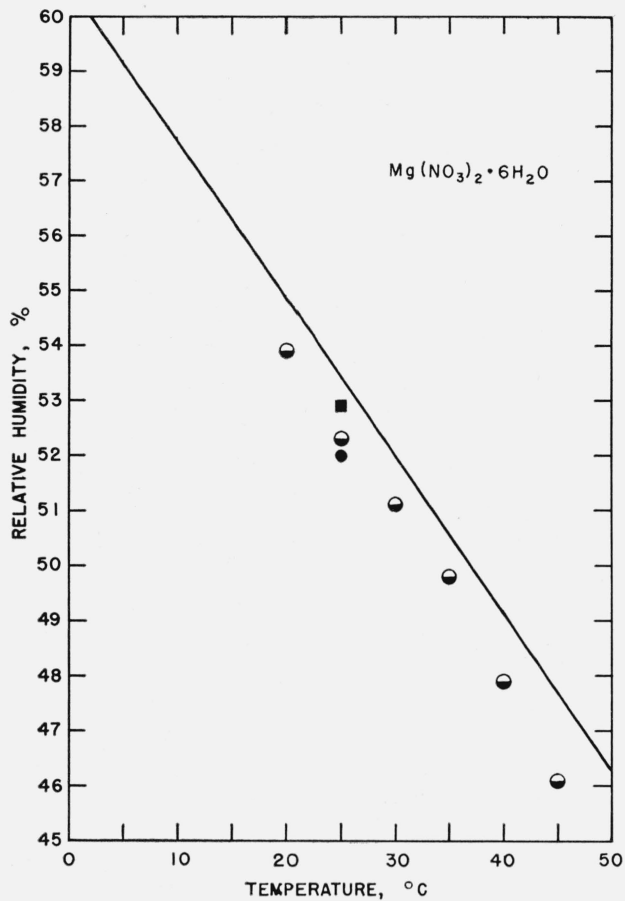

FIGURE 6.
(See fig. 3)

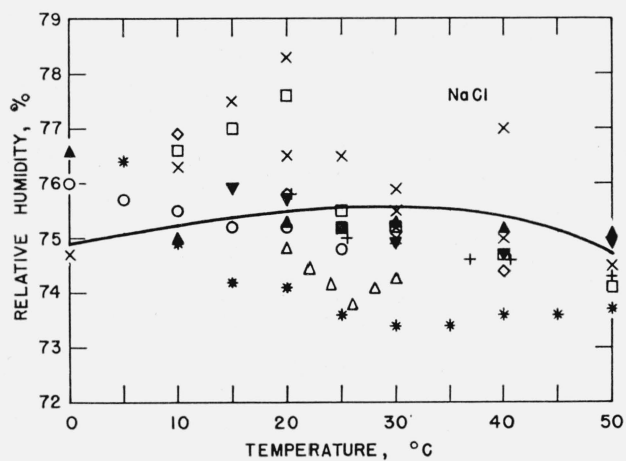

FIGURE 7.
(See fig. 3)

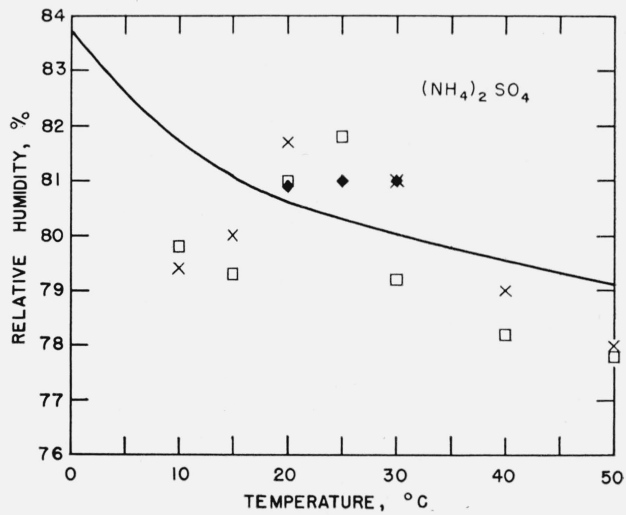

FIGURE 8.
(See fig. 3)

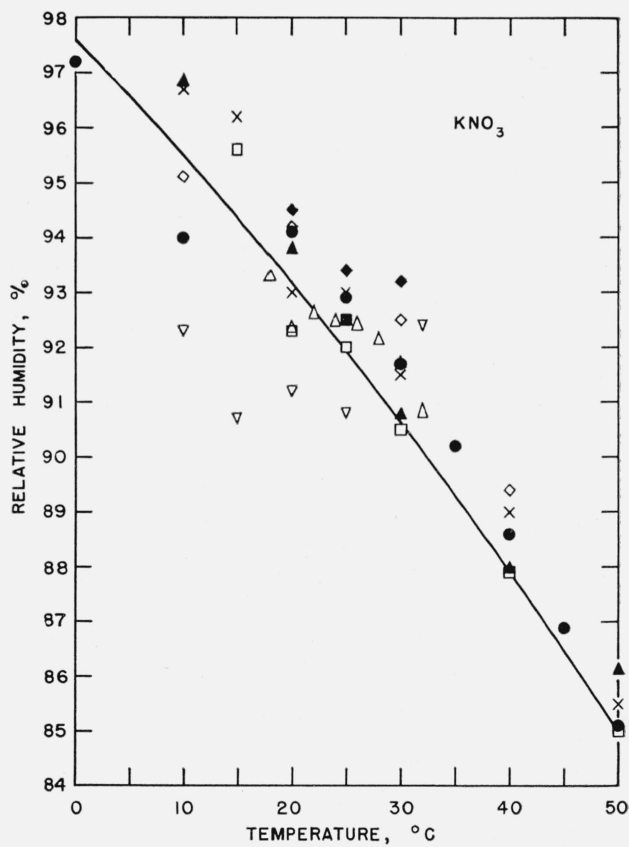

FIGURE 9.
(See fig. 3)

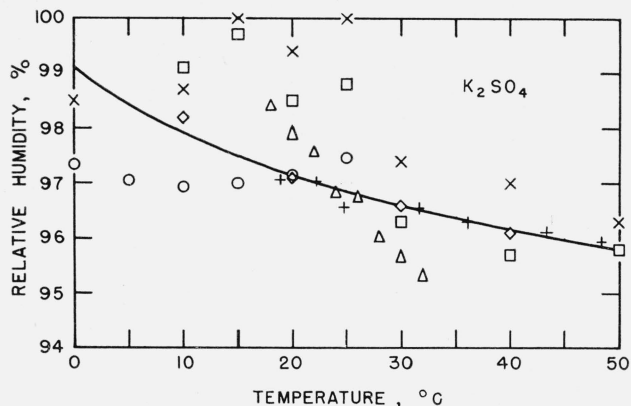

FIGURE 10.
(See fig. 3)

5. Discussion

5.1. General

There are several advantages to the use of the dewpoint method in determining the equilibrium relative humidity over a saturated salt solution. The experimental setup can be relatively simple, requiring only a temperature-controlled liquid bath for maintaining the salt solution and its containing vessel at some fixed temperature and a dewpoint detector. The dewpoint can be measured in the presence of an air (or other noncondensable) atmosphere. Methods that depend on the direct measurement of vapor pressure, either absolute or differential, require careful elimination of all gases and vapors except the water vapor from above the salt solution as well as the elimination of any dissolved gases in the solution because these would produce a serious error in the vapor pressure. The absolute accuracy of the vapor-pressure measurement increases with decreasing dewpoint for a given accuracy in the dewpoint measurement. For example, if the dewpoint is measured with an accuracy of 0.1 deg C, the corresponding accuracy in vapor pressure is 0.008 mm Hg at -20°C , 0.034 mm Hg at 0°C , 0.109 mm Hg at 20°C , and 0.296 mm Hg at 40°C . The accuracy, in terms of percentage of vapor pressure, is 0.8 percent at -20°C , 0.7 percent at 0°C , 0.6 percent at 20°C , and 0.5 percent at 40°C . Thus, the percentage accuracy in vapor-pressure determination by the dewpoint method, for a given dewpoint accuracy, is roughly independent of dewpoint or vapor pressure. The dewpoint method is an indirect method; it yields a temperature from which the vapor pressure is obtained by recourse to tables. One of the inherent limitations of the method lies in the basic accuracy of the tables. For most work, and particularly for this investigation, the standard tables are considered to have adequate accuracy.

5.2. Errors

In determining relative humidity by the dewpoint method, the principal errors arise in the measurement of the dewpoint temperature and the ambient temperature. The precision of the temperature measurement, using calibrated single-junction copper-constantan thermocouples and a calibrated precision potentiometer, was 0.01 deg C, but the accuracy was probably no better than 0.05 deg C. As (1) the thermocouple for measuring the dewpoint was imbedded only several hundredths of an inch below the surface of the dewpoint mirror, (2) the body of the mirror was copper, and (3) the rates of heating and cooling were uniform and slow, it seems reasonable to assume that any temperature differentials within or across the mirror were negligible, say, no more than 0.01 to 0.02 deg C. Because of the relatively low thermal conductivity of liquid water, the temperature differential across the thickness of a dew film was possibly of greater magnitude. In cooling, the mirror was colder than the exposed dew surface and in heating, it was warmer. Two factors tend to reduce the importance of this. First, by averaging the temperatures at which dew is first observed to appear and then disappear, the errors due to the differentials across the dew, because they are of opposite sign, tend to cancel. Second, by keeping the thickness and quantity of dew small, the differentials can be reduced to a minimum.

The manually operated and visually observed dewpoint hygrometer required a certain degree of skill for successful use. After some experience in its use, it was possible to control the rate of heating and cooling so that the mirror temperature could be followed easily with a potentiometer, the appearance and disappearance of dew could be detected readily, and the thickness of the dew deposit kept as small as desirable. An observer could repeat a series of, say, five dewpoint determinations, at any one time, with an average deviation of a single determination from the mean of 0.04 deg C, with an average deviation of the mean of 0.01 C, and with an average range of 0.13 deg C. The average difference in temperature between the appearance and disappearance of dew was 0.5 deg C, whereas the maximum difference ever observed was 2 deg C. The dewpoint appeared to be independent of the various observed differences in temperature between the appearance and disappearance of dew.

The dewpoint (the average, usually, of five repeat determinations) obtained by any one observer had an average deviation from the mean of two or more observers of 0.07 deg C. The average deviation of the mean dewpoint of all observers for a salt solution at any temperature was 0.04 deg C. The mean range in dewpoint for all of the test conditions for two or more observers was 0.16 deg C.

Because the dew was visually detected, it is likely that different observers used different criteria for defining the appearance or disappearance of dew.

This may account to some extent for the spread in dewpoint from one observer to another.

Below 0° C, either frost or dew (supercooled water) may be deposited on the surface of the dewpoint mirror. In all cases (which included dewpoints as low as -23° C) the deposit first detected was dew. If the mirror temperature was not permitted to fall too far below the dewpoint, then dew remained on the mirror throughout the determination. If the mirror temperature dropped appreciably below the dewpoint, the dew changed to frost.

The ambient temperature was taken as the mean temperature of the salt solution and air. These latter two temperatures differed from each other because of the heat sources and sinks associated with the setup. The fan used for stirring the air within the chamber introduced heat through agitation; conduction along the shaft added or abstracted heat, depending on whether the room temperature was above or below that of the test chamber. The dewpoint hygrometer served as a serious heat sink, for, by the very nature of its operation, it has to be maintained below test-chamber temperature. Although the insulation surrounding the conduction rod aided appreciably in reducing the magnitude of the heat loss, there was still enough loss to produce a temperature differential between the salt solution and air. The test-chamber temperature may therefore have an average uncertainty, because of this differential, of 0.09 deg C.

The root-mean-square uncertainty in the dewpoint determination is 0.07 deg C and in the ambient (test chamber) temperature is 0.10 deg C. The corresponding uncertainty in relative humidity varies from a maximum of 1.2 percent for the high-humidity saturated salt solutions to 0.2 percent for the low-humidity saturated salt solutions.

5.3. Comparison of Results With Those of Other Investigators

The NBS results are compared with those of other investigators in figures 3 to 10, in which the NBS results are shown as solid-line curves. The results of some workers were reported for a limited temperature range or, occasionally, for only one temperature. Wherever necessary, results that were presented in terms of vapor pressure were converted into relative humidity.

It is apparent from these figures that there is a certain degree of scatter among the values reported by other researchers as well as some disagreement between the NBS results and those values. In general, these other results fall within a band of values that is, on an average, roughly within $\pm 1\frac{1}{2}$ -percent relative humidity of the NBS results.

5.4. Use of Saturated Salt Solutions

When saturated salt solutions are employed for humidity control, experience has shown that certain precautions must be observed in order that the

theoretical values may be used without the need of measurement. It is necessary to enclose the saturated salt solution in a sealed chamber. The chamber and the fixtures therein must be made of non-hygroscopic materials, preferably metal or glass, else the time required for humidity equilibrium to be achieved may be very great, sometimes of the order of days or weeks. The chamber, salt solution, and ambient air should be brought to temperature equilibrium. It is desirable for the salt solution to occupy as large a surface area as possible and for some means of air ventilation or circulation to be provided. In the latter regard, if at all possible, the motor that drives the fan or blower should be external to the chamber. Otherwise, the heat dissipated by the motor will gradually raise the internal chamber temperature and introduce some uncertainty in the equilibrium relative humidity. The time required for humidity equilibrium to be reached with saturated salt solutions depends on several factors: (1) the ratio of free surface area of the solution to chamber volume, (2) the amount of air stirring, and (3) the presence of hygroscopic materials. It is conjectured that agitating the saturated salt solution may increase the rate at which equilibrium is achieved.

As ideal conditions are rarely obtained in practice, it is probable that the theoretical values of relative humidity are seldom reached. In general use, saturated salt solutions should not be expected to control the relative humidity to closer than about 1-percent relative humidity of the theoretical values.

6. References

- [1] Arnold Wexler and W. G. Brombacher, Methods of measuring humidity and testing hygrometers, NBS Circular 512 (1951).
- [2] International Critical Tables **1**, 68 (McGraw-Hill Book Co., New York, N. Y., 1927).
- [3] Smithsonian Meteorological Tables, 6th Revised Edition (1951).
- [4] H. W. Foote, Blair Saxton, and J. D. Dixon, The vapor pressures of saturated aqueous solutions of certain salts, *J. Am. Chem. Soc.* **54**, 563 (1932).
- [5] H. Geneva Leopold and John Johnston, The vapor pressure of the saturated aqueous solutions of certain salts, *J. Am. Chem. Soc.* **49**, 1974 (1927).
- [6] W. Sakai, The study of urea, *i.* The hygroscopic properties of (the) double substance. The vapor pressure of saturated solution(s) of salts, *J. Soc. Chem. Ind. Japan*, **43**, Suppl. binding 104 (1940).
- [7] J. R. Adams and A. R. Merz, Hygroscopicity of fertilizer materials and mixtures, *J. Ind. Eng. Chem.* **21**, 305 (1929).
- [8] Robert Burns, Conditioning of insulating materials for test, Bell Telephone System Monograph B-986 (1937). Source of material not given.
- [9] F. E. M. O'Brien, *J. Sci. Instr.*, **25**, 73 (1948).
- [10] A. Speranskii, The vapor pressure and integral heat of solution of saturated solutions, *Z. physik. Chem.* **78**, 86 (1912).
- [11] E. B. R. Prideaux, The deliquescence and drying of ammonium and alkali nitrates and a theory of the absorption of water vapor by mixed salts, *J. Soc. Chem. Ind.* **39**, 182-5T (1920).
- [12] G. Edgar and W. O. Swan, Factors determining the hygroscopic properties of soluble substances, *I.* Vapor pressure of saturated solutions, *J. Am. Chem. Soc.* **44**, 570 (1922).

- [13] R. H. Stokes and R. A. Robinson, *Ind. Eng. Chem.* **41**, 2013 (Sept. 1949).
- [14] J. H. van't Hoff, E. F. Armstrong, W. Hinrichsen, F. Weigert, and G. Just, *Gips und Anhydrit*, *Z. physik. Chem.* **45**, 257 (1903).
- [15] A. Speranskii, Vapor pressure of saturated solutions, *Z. physik. Chem.* **70**, 519 (1910).
- [16] D. S. Carr and B. L. Harris, *Ind. Eng. Chem.* **41**, 2014 (Sept. 1949).
- [17] M. H. Lescoeur, *Recherches sur la dissociation des hydrates salines et des composés analogues*, *Ann. Chem. Phys.* (7) **2**, 85 (1894).
- [18] I. H. Derby and Victor Yngve, Dissociation tensions of certain hydrated chlorides and the vapor pressures of their saturated solutions, *J. Am. Chem. Soc.* **38**, 1439 (1916).
- [19] N. V. Konduirev and G. V. Berezovskii, Vapor pressure of saturated solutions and hydrates of magnesium chloride, *J. Gen. Chem. (USSR)* **5**, 1246 (1935).
- [20] Warren W. Ewing, Ernest Klinger, and John D. Brandner, Vapor pressure-temperature relations and the heats of hydration, solution and dilution of the binary system magnesium nitrate-water, *J. Am. Chem. Soc.* **56**, 1053 (1934).
- [21] Ernest F. Johnson, Jr., and Melvin C. Molstad, Thermodynamic properties of aqueous lithium chloride solutions. An evaluation of the gas-current method for determination of thermodynamic properties of aqueous salt solutions, *J. Phys. & Colloid Chem.* **55**, 257 (1951).
- [22] F. H. Huttig and F. Reuscher, *Studien zur Chemie des Lithiums. I. Über die Hydrate des Lithiumchlorids und Lithiumbromids*, *Z. anorg. Chem.* **137**, 155 (1924).
- [23] Nevzat A. Gokeen, Vapor pressure of water above saturated lithium chloride solution, *J. Am. Chem. Soc.* **73**, 3789 (1951).

WASHINGTON, February 19, 1954.