

INVESTIGATIONS ON THE MEASUREMENT ACCURACY OF THE
ANALYTICAL PLOTTER WILD AVIOLYT AC 1

Gerhard Berg
Technical University Darmstadt
Institute of Photogrammetry and Cartography
Petersenstraße 13
D-6100 Darmstadt
Federal Republic of Germany
Commission II, Working Group II/1

Abstract:

Analytical plotters instead of classical mono-/stereo-comparators respectively analog restitution instruments are used more and more also for applications with extremely high precision demands. Therefore, there is a real need for the development of methods and proceedings which procure statements on the measurement accuracy of these instruments. The analytical plotter WILD Aviolyt AC 1, which is installed at the Institute of Photogrammetry and Cartography of Technical University Darmstadt has been investigated intensively for its accuracy by the aid of a precision grid plate. The results confirm the excellent accuracy properties of the AC 1 in an impressive way.

1. Introduction

In 1966 a Working Group of Commission II of the International Society of Photogrammetry had been established. Its aim was to set up general principles (standard tests) for checking the operating status and the accuracy of photogrammetric instruments. First results had been submitted already two years later at the Lausanne ISP-Congress. A final report with test recommendations for analog restitution instruments, mono- and stereo-comparators, rectifiers and plotting tables had been presented at the ISP-Congress in Ottawa (DÖHLER, 1972). But as at that time analytical plotters (APs) have not yet been important for practical applications, the final report of the Working Group didn't contain special recommendations for the investigation of these instruments. Today because of many reasons (grade of automation, data flow, flexibility, economy, quality of the results etc.) APs take more and more the place of classical photogrammetric instruments.

Moreover APs have a growing importance also in the field of digital photogrammetry, for instance by integration of video cameras into the measuring system (SCHEWE, 1988). Particularly because of the relative small size of the now available CCD-chips, many procedures of digital photogrammetry not yet can renounce of digitizing conventional photographs instead of taking directly digital images of an object by video cameras. And digitizing of photos can easily be performed by slightly modified APs.

Consequently there is a real need for the development of proceedings which allow statements on the accuracy of APs respectively make it even possible to improve their accuracy. Due to the fact that the measuring system of an AP is similar to that of classical comparators, it is evident that there are certain analogies with the testing procedures for comparators as they have been proposed e.g. by (DÖHLER, 1972) and (FRITZ, 1973).

If one compares the manufacturer's statements on the accuracy of the most important AP's (for example: KERN DSR-11, ZEISS PLANICOMP, WILD BC 2), it can be recognized that there are only negligible differences. The accuracy of these instruments is in the order of 2-3 μm , which also has been proved true by practical experience. For the most customary jobs (for example: aerial triangulation, stereo plotting) that is quite sufficient. Merely for the WILD Aviolyt AC 1 one can find an accuracy statement which is significantly higher (1.0 - 1.5 μm). At our institute in 1983 an AC 1 has been installed. From the beginning it was intended to apply the instrument also in the field of - conventional and digital - precision close range photogrammetry (BERG, 1986 and 1988). Therefore intensive investigations on the accuracy of the AC 1 have been performed, on which will be reported now. But at first the AC 1-measuring system and its calibration have to be described.

2. The measuring system and its calibration

The measuring system (Fig. 1) has been constructed strictly according to Abbé's comparator principle. Two precision glass scales with evaporated subdivisions (grid constant: 20 μm) and fixed zero markings for reference finding have been arranged mutually orthogonal. Together with linear encoders they yield the measuring information with a resolution of 1 μm .

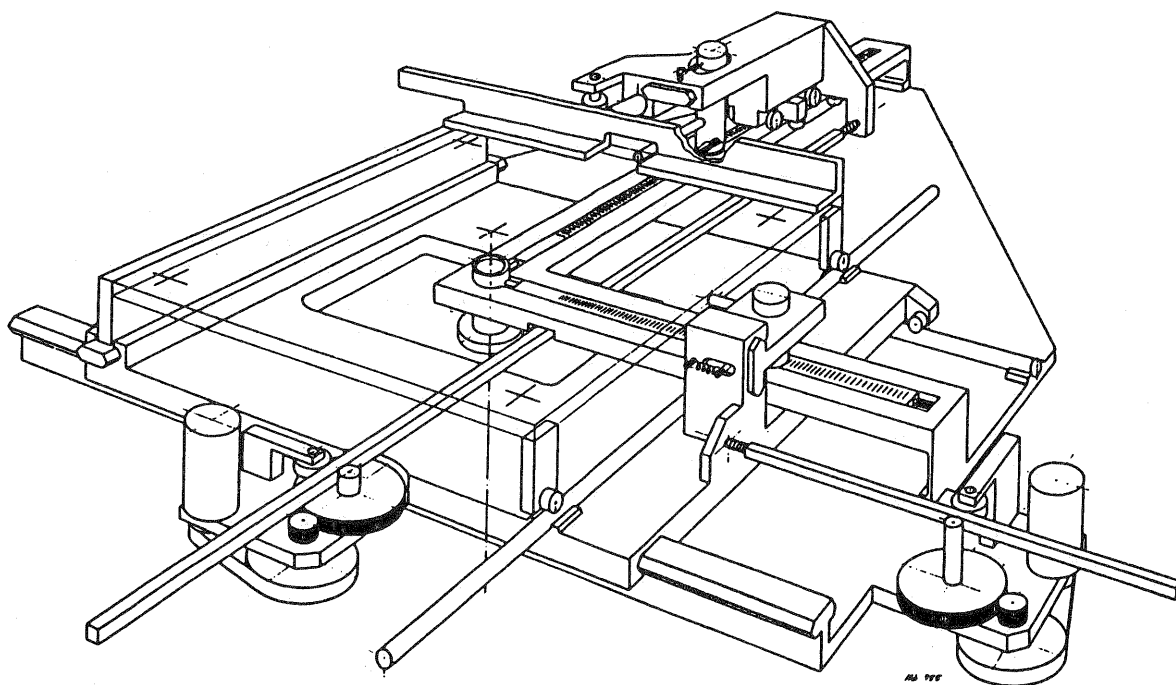
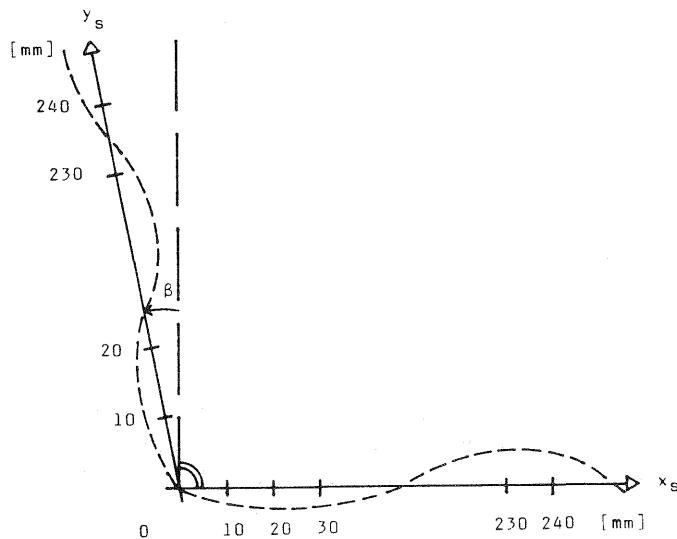

Fig. 1: Perspective view of the AC 1-measuring system

The straightness of the coordinate axes is guaranteed by costly constructive measures, among others by glass edges which have been cut at high precision. The driving system which consists of closed servo control loops with direct-current motors has constructionally been separated from the measuring system so that both systems do not influence each

other. The two precision glass scales in each measuring system respectively define an internal coordinate system which is called 'servo-coordinate-system' $\underline{x}_s = (x_s, y_s)^T$. Because of unavoidable tolerances during manufacturing and mounting it has to be expected that the servo coordinates \underline{x}_s not yet represent ideal rectangular coordinates as they are needed for photogrammetric applications. Especially the following deviations (errors) may occur (see also Fig. 2):



- The two glass scales may not be exactly orthogonal to each other;
 - they may have different scale factors;
 - within the glass scales certain scale tensions may occur;
 - the straightness of the coordinate axes may not be fulfilled perfectly.
- Some other error sources for example spindle errors, drag errors and errors because of the projection onto the scale axes, which may occur with other APs can be excluded at the AC 1 because of constructional reasons.

Fig. 2: Servo coordinates and possible errors

The influence of changes in the ambient temperature on the accuracy can be neglected under conventional conditions: the systematic reference shifting is in the order of only 0.2 μm per centigrade degree.

For the purpose of transformation the servo coordinates \underline{x}_s into ideal rectangular comparator coordinates $\underline{x}_k = (x_k, y_k)^T$ it has to be found a unique mathematical relation between these two coordinate systems so that we have

$$\underline{x}_s = f(\underline{x}_k) \quad (1)$$

and vice versa. This relation is called 'calibration function'. The choice of a proper calibration function is a problem which will be treated in the following. The WILD standard procedure for the calibration makes use of a 3 x 3 precision grid which has been engraved on each image-carrier. The rectangular coordinates of the 9 grid points (distance between the points: 90 mm) are known by a standard deviation of 0.2 μm . The calibration function is supposed to be an affine transformation, so that we have

$$\begin{aligned} x_s &= a_1 + a_2 \cdot x_k + a_3 \cdot y_k \\ y_s &= b_1 + b_2 \cdot x_k + b_3 \cdot y_k \end{aligned} \quad (2)$$

The determination of the 6 transformation parameters a_i, b_i $i = 1, 2, 3$ is done by a special calibration routine of the WILD system software.

One purpose of the investigations carried out was to find an answer on the question whether this standard procedure is sufficient for the complete description of all existing imperfections of the measuring system or, in other words, whether an extension of the calibration function respectively an addition of the number of grid points does lead to a better accuracy.

3. Investigations of the precision glass scales

As part of the final manufacturing control the subdivisions of the glass scales have been checked at intervals of 1 mm. The checking records have been made available by the manufacturer. The maximum positive resp. negative deviations from the correct length amounted for example for the x-glass scale of the right measuring system to + 0.32 μm resp. - 0.58 μm . By introduction of a scale factor (fitting straight line) the maximum deviations could be reduced to + 0.30 μm resp. - 0.37 μm . The RMS-deviation then amounted to only 0.15 μm . The results for the other 3 glass scales were in the same order, the RMS-deviations even amounted to only 0.12 - 0.13 μm . By that the high quality of the glass scales is clearly proved.

4. Further measurements and investigations

Moreover intensive measurements have been carried out using a precision grid plate with $23 \times 23 = 529$ grid points (distance between the grid points: 10 mm). The coordinates of the grid points are known by a standard deviation of 0.2 μm . Because of the high precision and the density of the grid points also complicated calibration functions can be established and evaluated.

4.1 Preliminary investigations

Prior to the calibration measurements some preliminary investigations have been carried out whose results are summarized now:

- the pointing accuracy (repeatability) is different for both directions x and y. The obtained standard deviations are 0.6 μm for x and 0.9 μm for y. The significant difference between x and y can easily be explained by the well-known properties of the human eye (FRITZ, 1973). With that the pointing accuracy has been found better than declared by WILD.
- There are no significant accuracy differences within the whole measuring range.
- The measuring result is not dependent on the direction from which the point is set up.
- The existence of a drag-error (model according to WOLF, 1975) can be excluded with high statistical significance.

4.2 Mensuration process

According to the recommendations of the ISP (DÖHLER, 1972) and the well-known publication of (FRITZ, 1973) the measurements have been carried out with a slightly turned grid plate (Fig. 3). The size of the angle θ resulted from the demand of an equidistant (0.4 mm) scanning of the glass scales. Thus the rotation θ provides an even sampling of possible nonlinear errors along the axes of the measuring system.

The measurements have been carried out by one operator. Altogether each grid point has been observed eight times: twice in

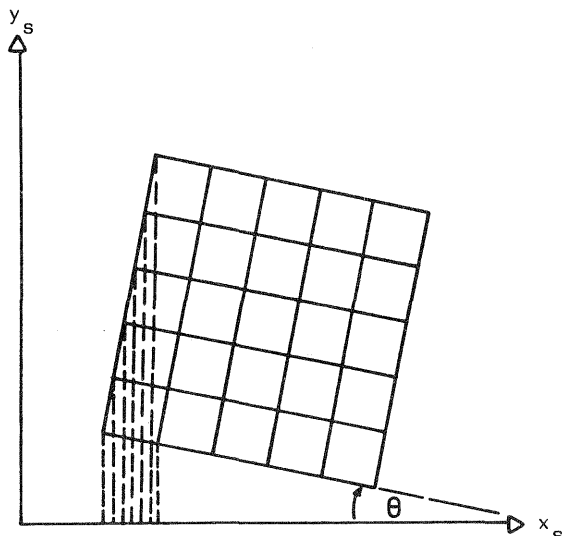

Fig. 3: Rotation of the grid plate

each of the four positions (cases), which resulted from a respective rotation of the grid plate by 100 gon. The extensive grid measurement have been performed at a 19-fold magnification and by assistance of a new developed measuring program, called SMO (WEISENSEE, 1985). This program which is based upon the WILD-system-software permits a far-reaching automation of the mensuration process. The operator's job is only the fine setting. In this way a high rapidity (about 6-10 points per minute) and an excellent quality of the measurements are obtained.

All described measurements have been performed for both the left and the right measuring system.

4.3 Computations and statistical analysis

The basis for the computations were the observed servo coordinates \underline{x}_s and the comparator coordinates \underline{x}_k of all grid points. The comparator coordinates have been assumed to be true. Thus we have 529 (grid points) x 8 (observations per grid point) x 2 (x_s - and y_s -coordinate) = 8464 single observations from which we have to determine the parameters of the calibration function by adjustment.

Two different models for the calibration function have been selected:

model I: affine transformation according to equation (2).
This model is equal to the model recommended by WILD.

model II: extended affine transformation, according to eq.(3):

$$\begin{aligned} x_s &= a_1 + a_2 \cdot x_k + a_3 \cdot y_k + a_4 \cdot x_k^2 \\ y_s &= b_1 + b_2 \cdot x_k + b_3 \cdot y_k + b_4 \cdot y_k^2 \end{aligned} \quad (3)$$

4.4 Results

The computations for both the right and the left measuring system of the AC 1 have been performed independently from each other. Thus also the results have to be presented one after the other.

4.4.1 Right measuring system

The performed investigations mainly refer to the residuals v_{x_s} and v_{y_s} of the observed servo coordinates as they have been obtained from the adjustment. Fig. 4 shows a diagram of the residuals as they resulted from the adjustment according to model I.

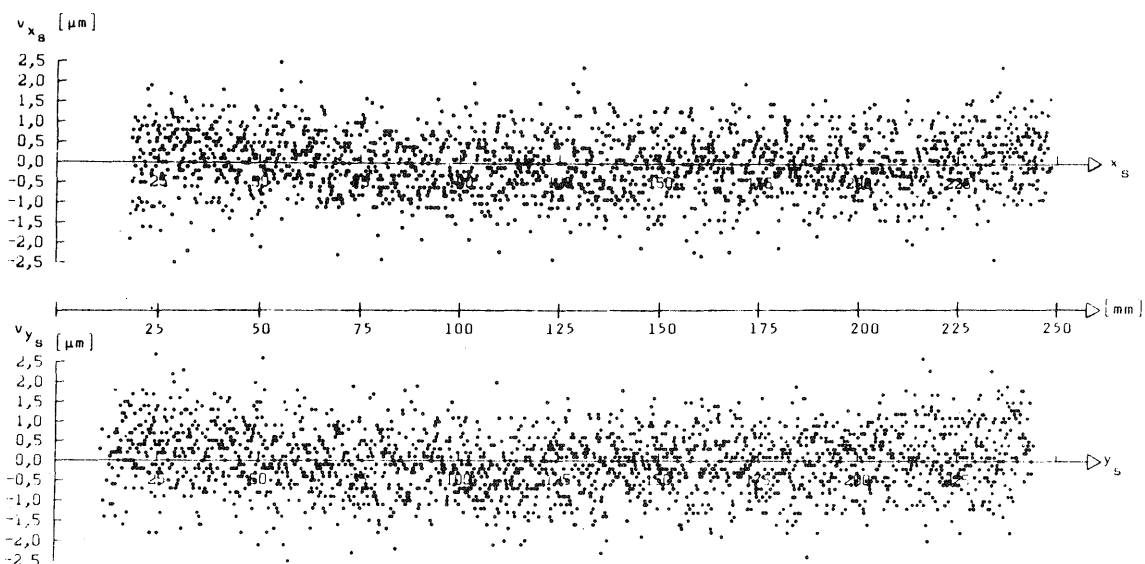

Fig. 4: Residuals resulted from model I

For both directions x_s and y_s it can easily be recognized that we have small deflections which lead to a larger number of positive residuals at the boundaries and to a larger number of negative residuals in the middle of the measuring range. As the effect of the deflections is only in the order of $0.2 - 0.4 \mu\text{m}$ at the boundaries and $0.2 - 0.3 \mu\text{m}$ in the middle it can certainly be neglected for practical photogrammetric applications.

Nevertheless a further adjustment has been performed, but now with additional parameters using model II. By that the standard deviation of the weight unit could be reduced, but only very slightly. Both additional parameters have been obtained significantly different from zero. The residuals of the observed servo coordinates for that model are shown in Fig. 5. Now the effect of deflections can be recognized no longer. Model II obviously is well-suited to compensate the ascertained small non-linear deviations.

A further investigation dealt with the questions whether the residuals are normally distributed, which among other things can be interpreted as one reference to a correctly selected calibration function. As test for normal distribution the χ^2 -test has been selected.

Fig. 6 shows exemplarily for the y_s -component of the servo system the actual and the theoretical frequencies for both models.

As it can be seen easily there are only slight differences between model I and model II. The hypothesis of normal distribution can be accepted for both models. Similar results have

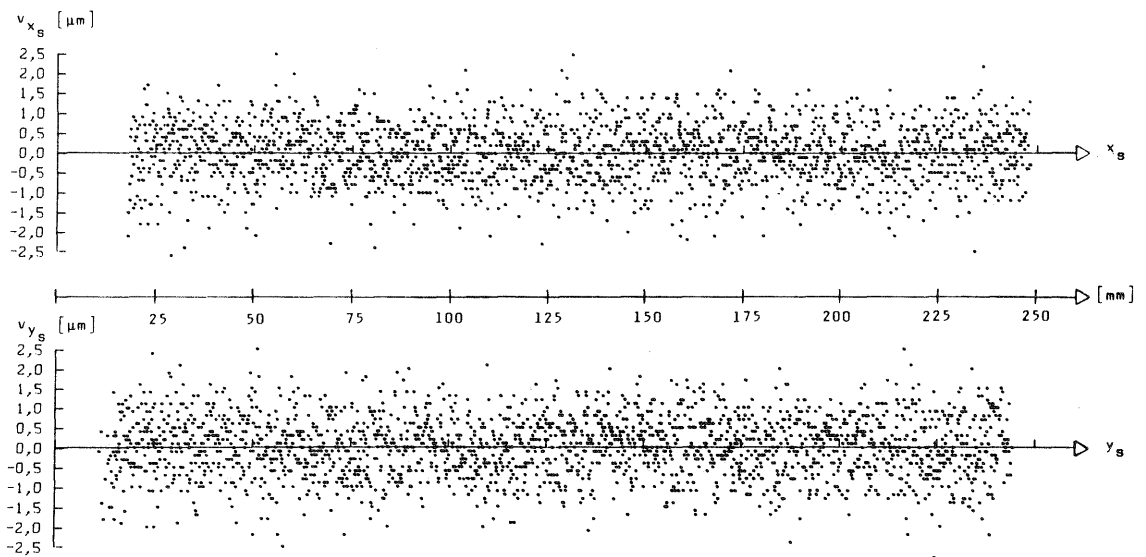

Fig. 5: Residuals resulted from model II

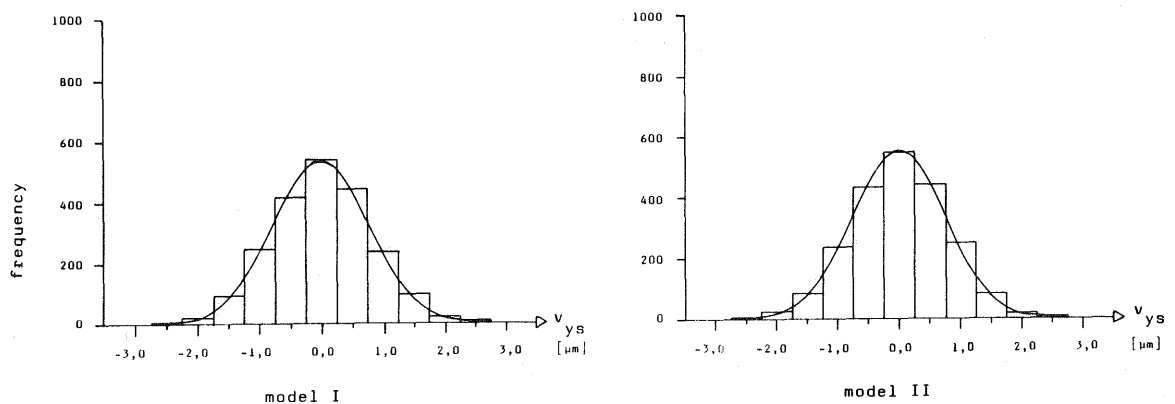

Fig. 6: Actual and theoretical frequencies of v_{y_s}

also been obtained for the x_s -component. The standard deviation of the normal distribution in all cases is in the order of 0.7 - 0.8 μm . As it has been shown in section 4.1 the pointing accuracy is in the same order (0.6 - 0.9 μm). Thus it can be concluded that the obtained standard deviations obviously depend in the first place on the accuracy of setting a grid point and only in the second place on the accuracy of the measuring system or, in other words, that the accuracy of the measuring system is better than the accuracy of setting. At last it has been investigated whether any periodic effects within the residuals can be recognized. For that purpose the power spectrum of the residuals for all computational variants have been determined (see for example Fig. 7). It could be found that there are no significant peaks within any power spectrum from which can be concluded that there are

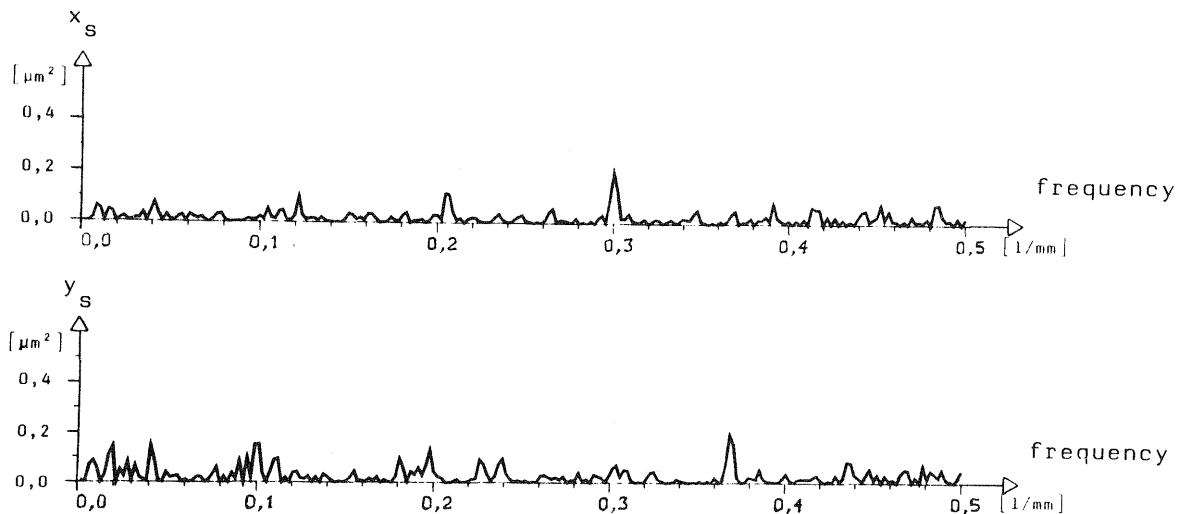

Fig. 7: Power spectrum for v_{xS} and v_{yS} (model II)

no significant periodic effects within the residuals. With that a further extension of the calibration function for periodic parameters is not required. On the contrary the mean energy level of the spectrum of less than $0.1 \mu\text{m}^2$ even can be explained only by rounding errors which follow from the resolution of the servo system.

4.4.2 Left measuring system

The favourable properties found for the right measuring system essentially have been proved true also for the left measuring system. The obtained accuracy is again $0.7 - 0.8 \mu\text{m}$ for both models. But in contrast to the right side no deflection effects could be recognized. The results even couldn't be improved by model II. Two further characteristics of the residuals have been found equal to the right side: normal distribution and the absence of periodic effects.

5. Conclusions

The performed investigations clearly confirm the excellent accuracy properties of the WILD Aviolyt AC 1. The measuring accuracy has been found to be $0.7 - 0.8 \mu\text{m}$. With that the accuracy statement of the manufacturer ($1.0 - 1.5 \mu\text{m}$) has significantly been exceeded. As it has been shown, under certain circumstances the calibration function can be improved slightly by a refined calibration model, but it can be doubted that there is a need for that in practical photogrammetric applications. The performed investigations can easily be applied also to other analytical plotters. Further projected investigations will deal with the question how to separate grid errors from errors of the measuring system, respectively how to calibrate the measuring system, if one renounces of a precision grid plate.

References:

- BERG, G., 1986: Application of Precision Close Range Photogrammetry for Quality Control and Documentation in Power Station Construction. Int. Arch. Phot. and Rem. Sens., Vol. 26, Part 5, pp. 159-164, Ottawa 1986.
- BERG, G., 1988: Analysing the Deformation Behaviour of a Reactor Pressure Vessel Using Analytical Deformation Models. XVI. Int. Congr. of ISPRS, Kyoto 1988.
- DÖHLER, M., 1972: Test-Empfehlungen für Analog-Auswertegeräte, Komparatoren, Entzerrungsgeräte, Orthoprojektoren, Koordinatographen. Presented Paper, ISP, Comm. II, WG 2, Ottawa 1972.
- FRITZ, L.W., 1973: Complete Comparator Calibration. NOAA Technical Report NOS 57, Washington 1973.
- SCHEWE, H., 1988: Automatische photogrammetrische Karosserie-Vermessung. Bildmessung und Luftbildwesen (BuL) 56, S. 16-24, Karlsruhe 1988.
- STEIGERWALD, H., 1985: Untersuchungen und Messungen zur Bestimmung der Genauigkeit des analytischen Stereoauswertegerätes WILD Aviolyt AC 1. Diplomarbeit (unveröffentlicht), Institut für Photogrammetrie und Kartographie, Technische Hochschule Darmstadt, 1985.
- STEIGERWALD, H., G. BERG, B. WROBEL, 1988: Untersuchungen zur Meßgenauigkeit des analytischen Stereoauswertegerätes WILD Aviolyt AC 1. Bildmessung und Luftbildwesen (BuL) 56, Karlsruhe 1988.
- WEISENSEE, M., 1985: Bedienungsanleitung zum Programm SMO zur rechnergestützten Gittermessung (unveröffentlicht). Institut für Photogrammetrie und Kartographie, Technische Hochschule Darmstadt, 1985.
- WOLF, H., 1975: Ausgleichsrechnung. Formeln zur praktischen Anwendung. Dümmler Verlag, Bonn 1975.